



**HAL**  
open science

## Managing the virtual collision in IEEE 802.11e EDCA

Mohamad El Masri, Slim Abdellatif

► **To cite this version:**

Mohamad El Masri, Slim Abdellatif. Managing the virtual collision in IEEE 802.11e EDCA. 8th IFAC International Conference on Fieldbuses and neTworks in industrial and embedded systems, May 2009, Ansan, South Korea. <hal-00389547>

**HAL Id: hal-00389547**

**<https://hal.science/hal-00389547v1>**

Submitted on 28 May 2009

**HAL** is a multi-disciplinary open access archive for the deposit and dissemination of scientific research documents, whether they are published or not. The documents may come from teaching and research institutions in France or abroad, or from public or private research centers.

L'archive ouverte pluridisciplinaire **HAL**, est destinée au dépôt et à la diffusion de documents scientifiques de niveau recherche, publiés ou non, émanant des établissements d'enseignement et de recherche français ou étrangers, des laboratoires publics ou privés.



HAL Authorization

# Managing the virtual collision in IEEE 802.11e EDCA

Mohamad El Masri<sup>\*,\*\*</sup> Slim Abdellatif<sup>\*,\*\*</sup>

<sup>\*</sup> CNRS ; LAAS ; 7 avenue du colonel Roche , F-31077 Toulouse, France.

<sup>\*\*</sup> Université de Toulouse ; UPS, INSA, INP, ISAE ; LAAS ; F-31077 Toulouse, France  
(e-mail: {masri,slim}@laas.fr)

---

**Abstract:** The IEEE 802.11e EDCA is the distributed channel access mechanism introduced by the Quality of Service amendment to the IEEE 802.11 standard. This mechanism introduces differentiation to the channel access. This led to the introduction of the principle of the virtual collision. We study, in this paper, the effect of the virtual collision management as presented by EDCA on its fairness among other properties. We give in this paper a new proposal of collision management for EDCA. The proposal is analyzed by means of a Markov Chain model of EDCA and its effects are discussed. The proposal reduces the unfairness of EDCA.

*Keywords:* Wireless Networks, 802.11e, Fairness, Quality of Service

---

## 1. INTRODUCTION

Introducing Quality of Service mechanisms into the IEEE 802.11 (802.11 (1999)) wireless access was done in the IEEE 802.11e amendment (802.11e (2005)). The amendment added support to a new access function called HCF (Hybrid Access Function). HCF combines two channel access mechanisms which are enhancements to the legacy channel access mechanisms: EDCA and HCCA. EDCA (the Enhanced Distributed Channel Access) is an enhancement of the legacy Distributed Coordination Function (DCF). EDCA introduces the medium access differentiation by adopting four different access categories (*AC*), each access category having a probabilistic priority for medium access. HCCA (the HCF Controlled Channel Access) is the enhancement of legacy PCF (Point Coordination Function), introducing deadline protection mechanisms to the centralized polling.

Traffic is enqueued in the different access categories following the value of the User Priority field 802.1D (2004). The four EDCA access categories are named Voice (*AC\_VO*), Video (*AC\_VI*), Best Effort (*AC\_BE*) and Background (*AC\_BK*). The medium access differentiation is introduced by defining different Contention Window ranges ( $[CW_{min}, CW_{max}]$ ) and different value of the Arbitration Inter Frame Space (AIFS). This work looks into the mechanisms of collision management implemented by EDCA. EDCA defines two types of collisions: the first is the classical collision (also called a real collision), it occurs when two (or more) access categories active within two (or more) different stations try to access the medium at the same time. The second type of collision is the internal (or virtual) collision. It occurs when at least two access categories within the same station try to access the medium at the same time. We explore the effect of the management of the virtual collision on the equity of access between access categories of the same priority in different

stations. EDCA's proposal of virtual collision management introduces iniquity in access that is directly related to the local (within the station) traffic profile, this was discussed in earlier work (Masri (2006)). We detail in this paper a new way for collision management for IEEE 802.11e EDCA. This proposal is discussed and analyzed.

The paper is organized as follows: we first give an overview of the access mechanism of EDCA. The second section explores the different problems introduced by the virtual collision management and discusses them. We then detail our solution and analyze it using a model of EDCA's behavior (Masri et al. (2007a)). The last section concludes on the issue and presents future work.

## 2. OVERVIEW OF EDCA

### 2.1 An *AC*'s behavioral view

We give an abstract view of an *AC*'s behavior (which we call  $AC_i$ ,  $i$  being its priority) in figure 1. The transmission of a packet is implemented through a series of access attempts. Each is based, at first, on the sequence of two processes (AIFS and backoff), defining the medium idleness test before the actual transmission attempt, and then on the actual transmission attempt (i.e. the decision to make a transmission). The result of each actual transmission is either a successful transmission (following which the sending of a new packet is considered) or a collision (following which the packet's retransmission is considered). Note that on the first transmission attempt of a packet we have:  $CW[AC_i] = CW_{min}[AC_i]$ . After a collision situation, the new value of the contention window is computed as follows:

$CW_{new}[AC_i] = \min(2 * CW[AC_i] + 1, CW_{max}[AC_i])$  in order to try to avoid further collisions. The value of the contention window will grow exponentially until reaching  $CW_{max}[AC_i]$ . The  $AC_i$  can attempt retransmitting a col-

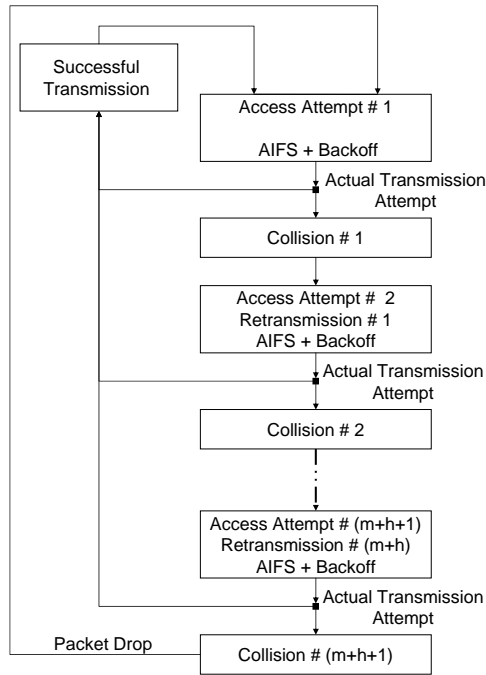

Fig. 1. Behavior of an AC

lided packet until the retransmission threshold is reached. When the retransmission threshold is reached, the packet is dropped and the transmission of a new packet is considered. *This abstract view highlights the basic behavioral patterns of EDCA: AIFS procedure, Backoff procedure, actual transmission attempt procedure and their results.*

## 2.2 The basic behavioral patterns

**AIFS procedure** Any transmission attempt starts with the random choice of the value of the Backoff Counter ( $B\_C[AC_i]$ ) within the current contention window range  $[0, CW[AC_i]]$  (this value defines the backoff time which will be used at the end of the AIFS period). The AIFS procedure consists in the necessity to observe the medium idleness during the AIFS period. If, during the AIFS period, the medium becomes busy, we have the AIFS decrementing freeze during the medium occupation time after which the AIFS countdown is reset. At the end of the last slot of AIFS, if the medium is still idle, two outputs are possible: if  $B\_C[AC_i] = 0$ , the AC will directly attempt a transmission; if  $B\_C[AC_i] > 0$ , the value of  $B\_C[AC_i]$  is decremented of one, thus initiating the backoff procedure.

**Backoff procedure** A backoff procedure will mainly consist in decrementing the value of  $B\_C[AC_i]$  while the medium is idle. The value of  $B\_C[AC_i]$  is decremented until it reaches 0, one slot after which a transmission is directly attempted if the medium is still idle. If during the backoff counter decrementing, the medium becomes busy, the decrementing procedure is stopped and frozen during a time which is the sum of the medium occupation time and an AIFS period, if during the AIFS period, the medium is busy again, the process is repeated. At the end of the last slot of AIFS, if the medium is still idle, two outputs are possible: if  $B\_C[AC_i] = 0$ , the AC will directly attempt a transmission; if  $B\_C[AC_i] > 0$ , the value of  $B\_C[AC_i]$  is decremented, thus resuming the backoff procedure.

**Actual transmission attempt** When an  $AC_i$  decides to initiate a transmission attempt, either it is the only one within the station to want to transmit, in which case it will directly access the medium, or there is at least another AC within the station also wishing to transmit, in which case both ACs will go into a virtual collision. Within the virtual collision handler, the AC winner of the virtual collision (thus accessing the medium) is the higher priority AC. If  $AC_i$  loses the virtual collision, then the medium will be accessed by an AC, virtually colliding with  $AC_i$  and having a higher priority. An actual transmission attempt is followed by three outcomes:

- (1) The transmission was successful, in which case  $AC_i$  occupied the medium for the duration of a successful transmission  $T_s$  and a new packet transmission (if present) is then taken into consideration; if there is no other packets to transmit,  $AC_i$  will perform a postbackoff procedure (ensuring that at least a backoff procedure is performed between two transmission opportunities of an access category).
- (2)  $AC_i$  suffered a real collision, in which case  $AC_i$  occupied the medium for a collided transmission time  $T_c$  and the packet may be retransmitted within the retry threshold limit.
- (3)  $AC_i$  lost a virtual collision, in which case  $AC_i$  did not occupy the medium, a higher priority AC within the station will transmit (either suffering a collision thus occupying the medium for  $T_c$  or transmitting successfully thus occupying the medium for  $T_s$ ).  $AC_i$ 's packet may be retransmitted within the retry threshold limit.

*Situations 2 and 3 above define what we call a collision situation for  $AC_i$ .*

## 2.3 Collision Management

In addition to the real collisions (physical collisions on the medium) that involve queues from two different stations, EDCA introduces a new kind of collisions : virtual collisions. Virtual collisions involve at least two queues belonging to the same station : if the backoff procedures of several different queues within the same station finish at the same time slot, the queue with highest priority will win the right to try to access the medium, the others will behave as if a real collision occurred (i.e. their contention windows are doubled within the contention window range).

## 3. THE PROBLEM OF COLLISION MANAGEMENT

### 3.1 Review of the literature

During the last years, the performance of IEEE 802.11e's EDCA mechanism has been extensively investigated using both high-level performance metrics (e.g. Throughput, delay) (Choi et al. (2003); Huang and Liao (2007); Thottan and Weigle (2006); Banchs et al. (2005); Kong et al. (2004) and low-level metrics (e.g. Probability of accessing/occupying a specific time slot) Bianchi et al. (2005). All this work contributed to get a better understanding of the differentiation access scheme of EDCA as well as to highlight and assess some of its limits (unfairness issues Casetti and Chiasserini (2004); Cagalj et al. (2005)

among others). Despite the panoply of research work related to EDCA, little paid attention to the virtual collision management. Indeed, most analytical models of EDCA that were used for analysis did not precisely capture the virtual collision behavior of EDCA (to our best knowledge, we are only aware of three tentative models that integrate the virtual collision management : Huang and Liao (2007); Engelstad and Osterbo (2005); Masri et al. (2007a)). Moreover, most present results with a number of stations contending for the channel, and with fairly equal shares of traffic allocated to each station and to each AC. We point out that in many real-life usage scenarios Internet traffic is often asymmetric with much downstream traffic from the access point to the end stations and little traffic in the reverse direction. In this situation, the virtual collision management has a noticeable impact on the service differentiation of EDCA and hence needs to be thoroughly investigated. This is mainly the objective of this work whose novelty is to highlight the inefficiency of EDCA in handling virtual collision in a non overloaded Wireless LAN and to propose a very simple but efficient modification of EDCA that improves fairness and throughput.

### 3.2 Prerequisites

In order to clearly expose the problem of collision management in EDCA, we first must define the different scenarios of collision within a station (figure 2) :

- $VC \circ RC$ : Scenario taking place when a Virtual Collision ( $VC$ ) occurs within a station followed by a Real Collision ( $RC$ ) on the medium as in figure 2-a.
- $VC \circ \overline{RC}$ : Scenario taking place when a Virtual Collision occurs within a station and no Real Collision ( $RC$ ) on the medium as in figure 2-b.
- $\overline{VC} \circ RC$ : Scenario taking place when a Real Collision occurs on the medium that has not been preceded by a Virtual Collision ( $\overline{VC}$ ) within the station as in figure 2-c.
- $\overline{VC} \circ \overline{RC}$ : Scenario where no Collisions, whatsoever, occur. An AC of the station accesses the medium with no problem (not represented in figure 2) .

### 3.3 Problem description

Collision management's essential purpose is protecting and improving medium utilization. However, in the case of a virtual collision, this is not always true. Consider a station with both an  $AC\_VO$  and an  $AC\_VI$  queue (note that both have the same values of AIFS and low ranges of contention window, which will cause them to have frequent virtual collisions). When both queues go into a virtual collision,  $AC\_VI$  having the least priority will have its contention window doubled,  $AC\_VO$  will access the medium. If no real collisions occur (scenario  $VC \circ \overline{RC}$ ), it is worthless to penalize the  $AC\_VI$  queue (this would have no positive effect on medium utilization). In addition to the previous, EDCA's virtual collision management presents several problems. The first is a problem of potential priority inversion.  $AC\_VI$  enduring virtual collisions may have the value of its contention window become bigger than (or at least equal to) that

of an  $AC$  of lesser priority ( $AC\_BE$  or  $AC\_BK$ ) not enduring virtual collisions. This problem is rare in case the default values of EDCA parameters (AIFS and contention window range) are used (802.11e (2005)), it may not be the case when the  $AC\_BE$  contention window range is lower. The other problem is that of fairness. EDCA assigns to each priority a set of characteristics (range of CW, IFS) that should be the same for all queues of the same priority within one Wireless LAN. In doing this, EDCA supposes that all queues of the same priority should have an equal chance of access to the medium. Because of the way it handles virtual collisions in certain local contexts, equal chance of access is not achieved. We define a local context of a given access category in a given station as the combination of: the number of active access categories within the station and their arrival profile. Consider two stations in a wireless LAN. The first, *station1* has its queues  $AC\_VO$  and  $AC\_VI$  being used. The second *station2* has its  $AC\_VI$  queue used. Both  $AC\_VI$  queues have the same arrival profile. However they are placed in different local contexts. To be *fair*, EDCA is supposed to give equal chance of access to the medium to both  $AC\_VI$  queues. In such a situation, *station1*'s  $AC\_VI$  is subject to virtual collision, this causes its contention window be greater than that of *station2*'s  $AC\_VI$  and its time-averaged throughput to be less.

## 4. SOLUTION PROPOSAL AND DISCUSSION

### 4.1 Theoretical solution: the omniscient Access Category

A first idea to solve the fairness problem is to have all access categories from the same level within all stations of the network have the same value of contention window at any time. This can be done by having the value fixed at all time, however the Binary Exponential Backoff (BEB) is necessary to reduce the collisions and improve the network utilization. In order to have both properties (that is to have the same value of contention window in all access categories of the same level and the BEB allowing reducing the collisions), each access category should be aware of any collision occurring in any other access category. When an access category suffers a collision (be it real or virtual), all other access categories from the same level should update the value of their contention window. This will allow guaranteeing a complete fairness among the access categories of the same level while still having active collision avoidance mechanisms. This, of course, is a theoretical solution which can not be implemented in reality. The amount of control messages necessary to have this solution renders it unfeasible.

### 4.2 Proposed modification

In order to solve the problems in 3.3 a modification proposal is made. We describe it hereafter : "*Conditional.VC.Penalization*". This modification is based on the following reasoning. The virtual collision management, as defined in 802.11e, justifies itself when having a lot of traffic with scenario  $VC \circ RC$  : the extension of CW, after a  $VC$  followed by an  $RC$  allows to lower the collision occurrence probability and thus to attain a better medium utilization. On the other hand, in case we have a wireless

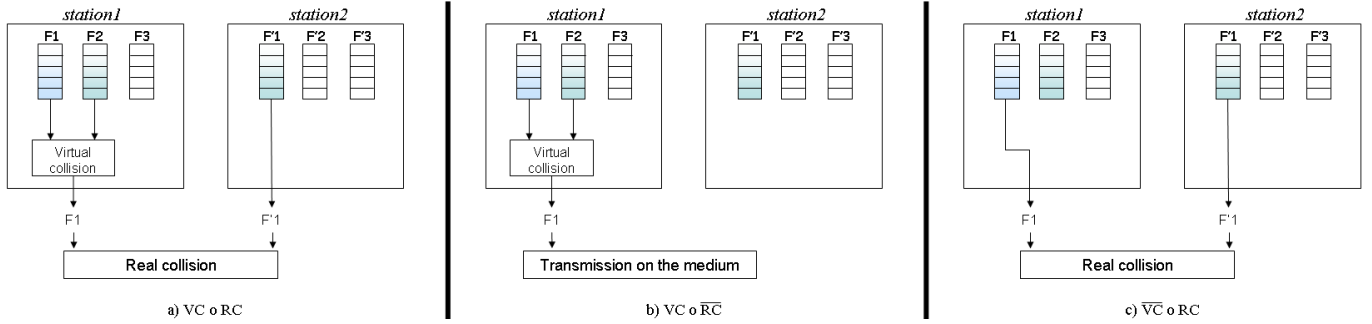

Fig. 2. Different possible scenarios a)  $VC \circ RC$ ; b)  $VC \circ \overline{RC}$ ; c)  $\overline{VC} \circ RC$

LAN with asymmetric traffic, then scenario  $VC \circ \overline{RC}$  will be frequent : several  $VC$  and a few  $RC$  will occur. It seems interesting not to extend the CW: this way, we avoid both the priority inversion and the unfairness discussed earlier without deteriorating the utilization of the medium. We can reason like this : if it wasn't for the virtual collision, the virtually collided access category would have accessed the medium; thereby, it would have been submitted to a real collision. We will thus penalize a virtually collided access category only if the access category that won the virtual collision collides once accessing the medium. We thus propose to adopt the following behavior : for a given  $AC$

- (1) in case it loses a virtual collision and no real collision follows (scenario  $VC \circ \overline{RC}$ ), the  $AC$  is not penalized.
- (2) in case it loses a virtual collision and the  $AC$  accessing the medium suffers a real collision (scenario  $VC \circ RC$ ) then the  $AC$  will be penalized.
- (3) in all other cases, EDCA's behavior is respected.

When an  $AC$  is penalized, its Contention Window is doubled within the contention window range. As for EDCA, the contention window is initialized before the first attempt of transmission of a packet.

The behavior of this proposal should be thoroughly studied as per its fairness and the throughput it achieves.

## 5. ANALYSIS AND DISCUSSION

### 5.1 The EDCA model

We used, for the analysis of our proposal, a Markov chain model of an EDCA access category that we developed and was presented in (Masri et al. (2007a) and Masri et al. (2007b)). This model is based on the three-dimensional discrete time Markov chain model of a saturated EDCA access category presented by Kong et. al. (Kong et al. (2004)). We added to the Kong model support to the virtual collision phenomena. This was necessary in order to precisely model the different behaviors an access category can adopt following a virtual collision and differentiate them from the behavior adopted following a real collision. The model presented in (Masri et al. (2007a)) models the classical EDCA management of a virtual collision. We derived from the model several metrics of performance analysis among which were the throughput of an access category in a traffic profile, the mean access delay of the access category and the drop probability. We introduced our proposal of collision management into the model and

derived the necessary metrics. We do not present the new model herein since it is both straightforward and out of the scope of this paper. Both the classical model and the modified model were used in the following analysis.

### 5.2 Analytical performance analysis

We present here the results of the performance analysis we undertook to study the effect of our proposal in different scenarios. Note that, due to the nature of the model we used, active queues in the following scenarios are necessarily saturated. We will first present the different scenarios we analyzed, then a thorough analysis will be given.

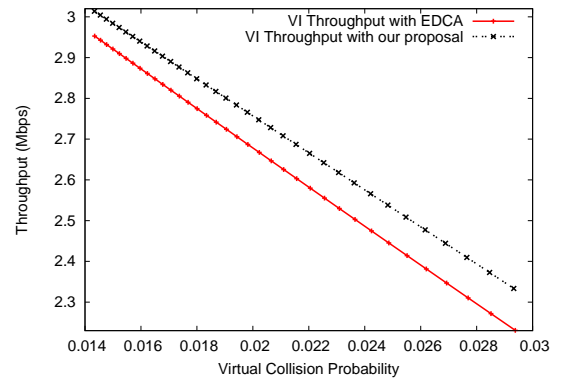

Fig. 3. Scenario 1,  $AC\_VI$  throughput

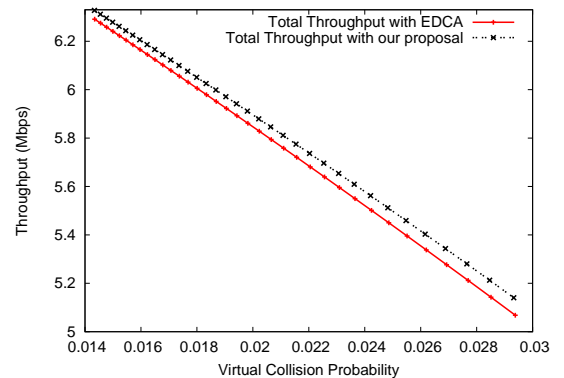

Fig. 4. Scenario 1, Total throughput

*Scenario 1* In scenario 1, the network contains only 1 station. This station has both  $AC\_VO$  and  $AC\_VI$  active. We performed the analysis for different values of the

packet size (this was done by modifying one of the entry variables of the model: the duration, in terms of slots of a successful transmission). Varying a packet size will mainly affect the probability of virtual collisions since it will affect the probability of access, the real collision is null in this scenario since we only have one station in the wireless LAN. We compare the performance of our proposal and that of EDCA by comparing the throughput of *AC\_VI* access category achieved in both behaviors (figure 3). We also show the total throughput achieved by the station using both behaviors (figure 4).

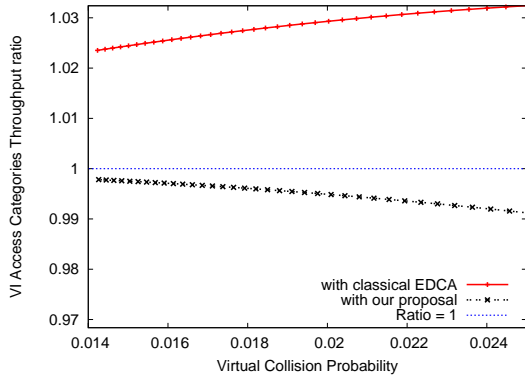

Fig. 5. Scenario 2

*Scenario 2* Scenario 2 of performance analysis is the one used to show the fairness problem we presented earlier 3.3. Two stations are active in the network, the first has both the *AC\_VO* and the *AC\_VI* active (type 1 stations). The second has only its *AC\_VI* active (type 2 station). EDCA's fairness would mean that, even though the first *AC\_VI* have an active *AC\_VO* within its station, independence of access functions should imply an equivalent throughput for both *AC\_VI*s. However EDCA is unfair towards the first *AC\_VI* due to the way it handles the virtual collision. We performed the analysis for different values of the packet size (this was done by modifying one of the entry variables of the model: the duration, in terms of slots of a successful transmission). Varying a packet size will mainly affect the probability of virtual collisions since it will affect the probability of access, the real collision will vary only moderately since we only have two stations in the wireless LAN. We compare the performances of both our proposal and of EDCA by analyzing the ratio of throughput of both *AC\_VI*s (Throughput of the non virtually collided *AC\_VI* to the throughput of the virtually collided one, if this ratio is 1, then fairness is achieved). Figure 5 presents this result to the occupation probability in the network.

*Scenario 3* In scenario 3 we have one station with both *AC\_VO* and *AC\_VI* active (type 1 station) and  $N$  stations with only *AC\_VI* active (type 2 stations). This scenario will help us analyze the effect of a growing real collision probability on our approach, since the number of stations has a direct effect on the probability of real collision in the model. Figure 6 gives the ratio of the throughput of one *AC\_VI* not submitted to the virtual collision to the throughput of the *AC\_VI* in the first station (the throughput of all non-virtually collided *AC\_VI* is the same). Figures 7 and 8 compares the total throughput of all access categories of the network using both approaches

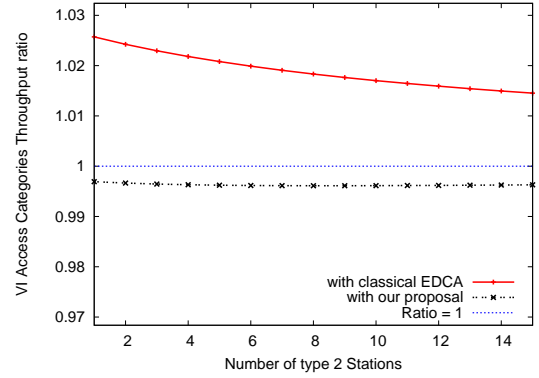

Fig. 6. Scenario 3

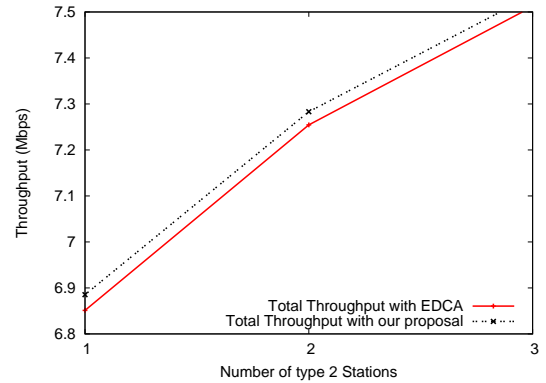

Fig. 7. Total throughput in Scenario 3, low number of stations

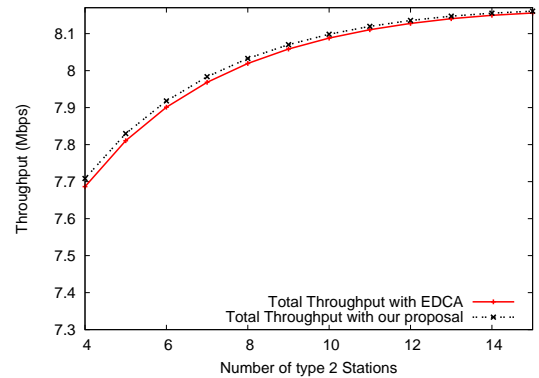

Fig. 8. Total throughput in Scenario 3, high number of stations

(we divided the results into two phases, one with a low number of stations, another with a higher number of stations).

*Analysis* **The first scenario** shows us how our approach improves the throughput of the *AC\_VI* access category (figure 3) in a context with no real collisions by reducing the mean value of its contention window. Our approach will also allow a better total throughput of the station (figure 4). We will analyze the effect of varying the different collision probabilities in the following sections. The total throughput decreases as the virtual collision probability increases. This is due to the way we increase the virtual collision probability: by reducing the size of a

packet. Every successful access will carry less user data, the throughput will thus be less. **The second scenario** (figure 5) shows that, when the probability of virtual collisions grows, the unfairness grows for both behaviors, in opposite directions (the curves are moving away from 1). The virtual collision being a local event, its effect will stay local which will add to the unfairness. In our proposal, the unfairness is inverted and reduced. The throughput of the virtually collided access category becomes higher than that of the non-virtually collided access category, but the ratio is nearer to 1. **In the third scenario**, it can be clearly seen in figure 6 how the growing real collision will reduce the unfairness of EDCA. This is due the fact that, even though the *AC\_VI* access categories from type 2 stations are not suffering virtual collisions, they might find themselves in the same situation than the *AC\_VI* of type 1 station because of the real collisions. However, our approach will still keep a reduced unfairness versus EDCA. The ratio will be stable with our approach: increasing the real collision probability will have an effect on both the virtually collided and the non-virtually collided access categories. Figure 7 shows that our approach will improve the total throughput of the network when a low number of stations (and thus a low real collision probability) is active. This can be correlated with the results of scenario 1. When the number of stations become higher, the real collision probability is higher and thus our approach's behavior will tend to EDCA's behavior; our approach will not reduce the total utilization of the network. **Generally**, the unfairness is highly reduced. The ratio of the non-virtually collided access category to the virtually collided is nearer to 1 with our proposal. EDCA's procedure negatively affects an access category that virtually collides even though the virtual collision does not have an effect on the utilization of the network, our approach reduces this negative effect. Although our proposal does not achieve a perfect fairness among its queues (such a fairness would necessitate implementing the theoretical solution), it manages to attain a certain degree of fairness among access categories from the same priority level.

## 6. CONCLUSION

This paper looked into the different aspects of the collision management as established by IEEE 802.11e EDCA. An internal collision with no direct effect on the medium was considered exactly as a real collision. We point out several problems caused by this behavior, the most serious of which was an unfairness among access categories from the same priority level. This problem can be frequent in a context where traffic is asymmetric. A proposal to modify this behavior so as to penalize a virtual collision only if it is followed by a real collision. The proposal was analyzed in several collision contexts, we show that our proposal manages to reduce the unfairness of EDCA without reducing the total utilization of the medium. This work should be extended in a direction that would adapt the behavior of EDCA towards collisions to the state of occupation of the medium.

## REFERENCES

802.11 (1999). *International Standard for Telecommunications and Information Exchange between Systems –*

- LAN/MAN specific Requirements – Part 11: Wireless LAN MAC and PHY specifications.*
- 802.11e (2005). *IEEE Standard for Telecommunications and Information Exchange between Systems – LAN/MAN specific Requirements – Part 11: Wireless LAN MAC and PHY specifications – Amendment 8: Medium Access Control QoS Enhancements.*
- 802.1D (2004). Lan man standards committee of the ieee computer society prepared by the interworking task group of ieee 802.1.
- Banchs, A., Azcorra, A., Garcia, C., and Cuevas, R. (2005). Applications and challenges of the 802.11e edca mechanism: an experimental study. *Network, IEEE*, 19(4), 52–58.
- Bianchi, G., Tinnirello, I., and Scalia, L. (2005). Understanding 802.11e contention-based prioritization mechanisms and their coexistence with legacy 802.11 stations. *Network, IEEE*, 19(4), 28–34.
- Cagalj, M., Ganeriwal, S., Aad, I., and Hubaux, J.P. (2005). On selfish behavior in csma/ca networks. *INFOCOM 2005. 24th Annual Joint Conference of the IEEE Computer and Communications Societies. Proceedings IEEE*, 4, 2513–2524 vol. 4.
- Casetti, C. and Chiasserini, C.F. (2004). Improving fairness and throughput for voice traffic in 802.11e edca. In *Personal, Indoor and Mobile Radio Communications, 2004. PIMRC 2004. 15th IEEE International Symposium on*, volume 1, 525–530 Vol.1.
- Choi, S., Del, Sai, and Mangold, S. (2003). Ieee 802.11e contention-based channel access (edcf) performance evaluation. In *Communications, 2003. ICC '03. IEEE International Conference on*, volume 2, 1151–1156 vol.2.
- Engelstad, P.E. and Osterbo, O.N. (2005). An analytical model of the virtual collision handler of 802.11e. In *MSWiM '05: Proceedings of the 8th ACM international symposium on Modeling, analysis and simulation of wireless and mobile systems*, 255–259. ACM, New York, NY, USA.
- Huang, C.L. and Liao, W. (2007). Throughput and delay performance of ieee 802.11e enhanced distributed channel access (edca) under saturation condition. *Wireless Communications, IEEE Transactions on*, 6(1), 136–145.
- Kong, Z., Tsang, D.H.K., Bensaou, B., and Gao, D. (2004). Performance analysis of ieee 802.11e contention-based channel access. *IEEE Journal on selected areas in communications*, 22(10), 2095–2106.
- Masri, M.E. (2006). Ieee 802.11e : the problem of the virtual collision management with edca. *Proceedings of IEEE Infocom Student Workshop '06.*
- Masri, M.E., Juanole, G., and Abdellatif, S. (2007a). Revisiting the markov chain model of ieee 802.11e edca and introducing the virtual collision phenomenon. *International Conference on Wireless Information Networks and Systems, WINSYS '07.*
- Masri, M.E., Juanole, G., and Abdellatif, S. (2007b). A synthetic model of ieee 802.11e edca. *International Conference on Latest Advances in Networks, ICLAN '07.*
- Thottan, M. and Weigle, M.C. (2006). Impact of 802.11e edca on mixed tcp-based applications. In *WICON '06: Proceedings of the 2nd annual international workshop on Wireless internet*, 26. ACM, New York, NY, USA.