



**HAL**  
open science

## **Estimation of Direction of Arrival (DoA) of DVB-T Signals in Mobile Receiving Configuration**

Franck Nivole, Christian Brousseau, Stéphane Avrillon, Dominique Lemur,  
Louis Bertel

► **To cite this version:**

Franck Nivole, Christian Brousseau, Stéphane Avrillon, Dominique Lemur, Louis Bertel. Estimation of Direction of Arrival (DoA) of DVB-T Signals in Mobile Receiving Configuration. MTA Review / Military Technical Academy Review, 2009, XIX (2), pp.ISSN 1843-3391. hal-00389195

**HAL Id: hal-00389195**

**<https://hal.science/hal-00389195>**

Submitted on 28 May 2009

**HAL** is a multi-disciplinary open access archive for the deposit and dissemination of scientific research documents, whether they are published or not. The documents may come from teaching and research institutions in France or abroad, or from public or private research centers.

L'archive ouverte pluridisciplinaire **HAL**, est destinée au dépôt et à la diffusion de documents scientifiques de niveau recherche, publiés ou non, émanant des établissements d'enseignement et de recherche français ou étrangers, des laboratoires publics ou privés.

# ESTIMATION OF DIRECTION OF ARRIVAL (DOA) OF DVB-T SIGNALS IN MOBILE RECEIVING CONFIGURATION

*F. Nivole, C. Brousseau, S. Avrillon, D. Lemur, L. Bertel*

IETR, Institut d'Electronique et de Télécommunications de Rennes , Université de Rennes 1  
Campus de Beaulieu, 35042, RENNES Cedex, FRANCE  
phone: + (33) 2 23 23 62 31, fax: + (33) 2 23 23 56 16, email: christian.brousseau@univ-rennes1.fr  
web: www.ietr.org

## ABSTRACT

To improve the quality of the mobile reception of DVB-T (Digital Video Broadcasting on Terrestrial networks) signal, the knowledge of the propagation channel characteristics is necessary. In this aim, this paper presents sounding methods and results for the estimation of Direction of Arrival (DoA) of DVB-T signals in mobile receiving configuration. The mobile passive sounder is presented, including post-processing and radio direction finding tools. Then several results in three kinds of environment are given.

## 1. INTRODUCTION

The aim of the CAVITE project [1] is to improve the reception of DVB-T signal in mobile conditions (car, train ...) characterized by important propagation effects (Doppler, delay spread ...). The first step of this project is to evaluate the spatial and time propagation channel characteristics, to ensure that diversity exists and that it could be exploited to increase the quality of received images on vehicular board

By the past, IETR laboratory has already worked in the HF frequency band (3-30 MHz) and has developed a HF modem that is able to increase the transmission data rate using strong reception processing and heterogeneous antenna array [2, 3].

DVB-T (Digital Video Broadcasting on Terrestrial networks) system uses COFDM transmission. This modulation is suitable to high numerical data rate transmission but is very sensitive to Doppler frequency shift, noise and fading effects. One way to improve the DVB-T reception for mobile application, like car, train..., is to use heterogeneous antenna array. The choice of these antennas is critical and it is necessary to have a good knowledge of the propagation channel effect. The challenge for channel sounding is to get information from broadcasted DVB-T received signals with an omni-directional angle, under fading condition, horizontal polarization and antennas mounted on a car roof.

## 2. MULTI-ANTENNA MOBILE SOUNDER AND SIGNAL PROCESSING

### 2.1 DVB-T French Broadcast System

The COFDM DVB-T system in France uses the following parameters [4] described in table 1, with a sampling time equals to  $7/64 \mu s$ .

The parameters chosen in France for DVB-T are done for static reception. The guard interval is not suitable to great time delay between DVB multi-paths, and the 64QAM modulation needs a high SNR level to get a good reception quality.

Mode	8 k
Guard interval	256 x sampling rate
Symbol duration	8192 x sampling rate
Total symbol duration	8448 x sampling rate
Modulation	64 QAM

Table 1: List of COFDM DVB-T parameters.

The network is a Multi-Frequency Network (MFN) with large distance between transmission stations and with different frequency plans for the same TV program in each part of country.

### 2.2 Description of multi-antenna passive sounder

The diversity receiving system uses four coherent super heterodyne receivers built in the IETR laboratory. The local oscillator is a RF generator with power divider to use the same level in all LO input mixers and the same phase for each input. The phase coherence is necessary for direction finding algorithms, because those ones use the geometric phases of the antenna array to estimate the Direction of Arrival (DoA).

The first stage is shown in figure 1. Each input uses RF bandpass filter and a Low Noise Amplifier (LNA) to ensure a good condition of reception (each way is calibrated before measurement and the first way is taken as reference).

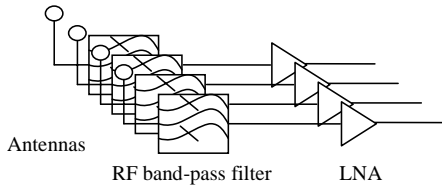

Figure 1: Input RF first stage.

Following the first stage, a mixer and a RF generator used as local oscillator down-convert the RF frequency to an intermediate frequency of 36.125 MHz (figure 2). The interferences and analog TV are cut-off by a SAW filter.

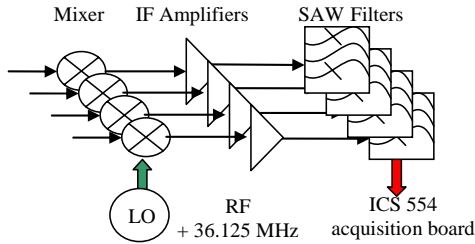

Figure 2: Input RF second stage.

Then, an amplifier in each channel matches the output signal level to the desired input level of the ICS 554 data acquisition board. Finally, a quadrature down conversion is done to ensure complex data processing. The down converter has a sampling rate of 100 Ms/s. The used decimation ensures a rate of 25 Ms/s (a resampling to the DVB-T FFT sampling rate is done by software to get about 9.145 Ms/s of sampling rate). Photo of the RF front-end and acquisition systems are shown in the figure 3.



Figure 3: Receiving and acquisition system.

Many antennas have been developed and tested [5][6]:

- Big wheel antenna,
- Patch and patch array,
- Wideband dipole,
- Pie-shaped antenna,
- Halo and printed halo antenna array,
- Loop antenna.

Regarding the channel sounding requirements, an array of 2 halo printed antennas has been chosen because:

- Features can be kept between each realized antenna,
- Gain of array allows good reception,

- Omni-directionality is ensured,
- Antennas size is suitable for multi-antenna array.

Halo dimension features are described in figure 4 and the figure 5 shows the twice coupled antenna.

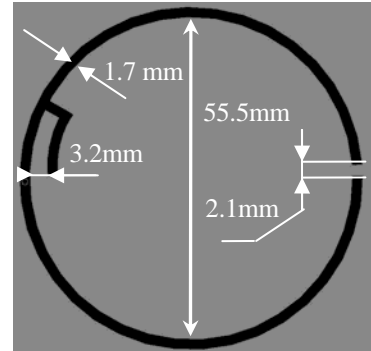

Figure 4: Halo Antenna on FR4 substrate.

To characterize the DVB-T propagation channel, a circular array of 4 pairs of printed halo antenna is used (figure 6). The figure 7 shows the azimuth and elevation configuration regarding network and antenna input number.

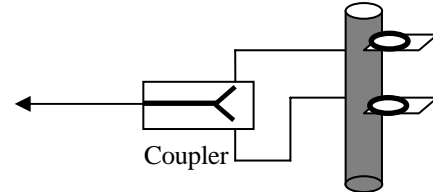

Figure 5: Twice printed halo antenna with coupler.

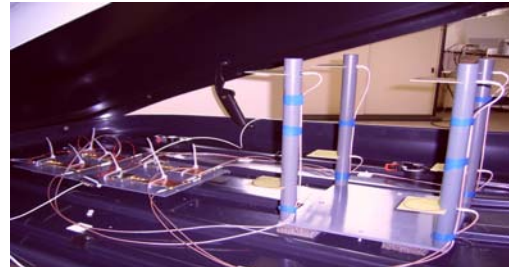

Figure 6: Array of two printed and coupled Halo array.

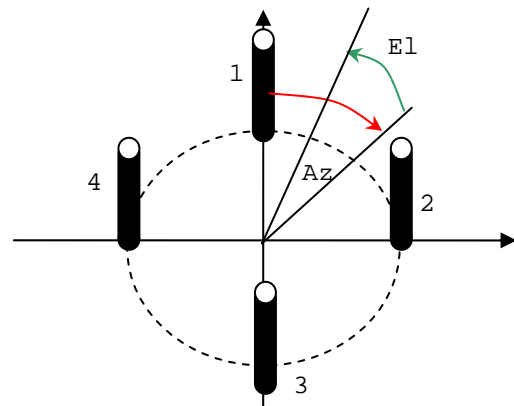

Figure 7: Array configuration.

### 2.3 Acquisition and post-processing software

The input signals are obtained from DVB-T broadcasted signal in mobile configuration. The system uses ICS554 acquisition card that gives several snapshots of broadcasted

symbols. The post processing is performed with software developed by laboratory [5], according to the recommendations of [7]. Figure 8 shows the man machine interface done to simplify the use of the post-processing software.

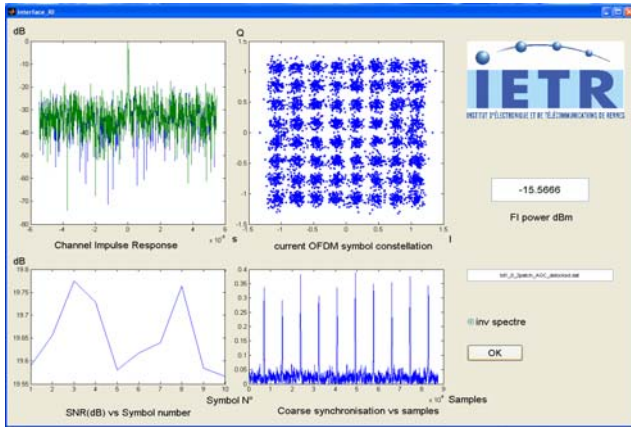

Figure 8: IETR tools for DVB-T demodulation.

The data which appear in this interface are:

- Measured channel impulse response,
- Measured OFDM constellation,
- SNR as a function of symbol,
- Coarse synchronization as a function of sample.

Then, the tools give the number of paths that can be found inside OFDM DVB-T signal. To improve the reception of DVB-T signal, analysis is then done by a radio direction finding estimation (DoA) to select the suitable antennas and their best locations and orientations. DoA analysis is done with two algorithms, first is the Capon method and the second is the MUSIC high resolution algorithm.

## 2.4 Radio direction finding tools

### 2.2.1 Capon method

The Capon method algorithm [8] uses the covariance matrix of samples vectors  $X$ :

$$R_{XX} = \frac{1}{N} \sum_{n=1}^N X(n)X(n)^T \quad (1)$$

Where  $n$  is the sample number,  $N$ , the number of samples, and  $\cdot^T$ , the transposition.

Then, the Capon spectrum is given by:

$$P_{capon}(Az, El) = \frac{1}{a(Az, El)^T \cdot R_{XX} \cdot a(Az, El)} \quad (2)$$

Where  $Az$  is the azimuth angle,  $El$ , the elevation angle, and  $a$ , the steering vector of the antenna array.

### 2.2.1 MUSIC high resolution algorithm

This algorithm [9] uses an Eigen-decomposition of the covariance matrix  $R_{xx}$  (Eq. 1). The aim is to separate the samples in two orthogonal subspaces. The first is the noise subspace and the second is the signal one.

After the Eigen decomposition, the number of sources  $NSE$  is evaluated by the most important Eigen values. Then, a pseudo spectrum  $PSSP$  is determined using the normalized steering vector  $b(Az, El)$  of antenna array.

It is given by:

$$PSSP(Az) = \frac{1}{\sum_{k=NSE+1}^{NC} |v_k^T \cdot b(Az, El)|} \quad (3)$$

Where  $NC$  is the number of sensors,  $k$ , the sensor number,  $v_k^T$ , the eigenvector and  $b = a/(NC)^{1/2}$ , the normalized steering vector.

The maximum as a function of azimuth and elevation angles gives the DoA of DVB-T propagation paths.

## 3. FIELD TESTS

For the measurements, a car was equipped with the 4 inputs diversity receiver and the antennas were mounted on the vehicle in a roof box. Figure 9 shows the embedded mobile system inside the car.



Figure 9: Photo of the embedded system inside the car.

In order to provide useful measurements, two measurement campaigns have been performed:

- In the north of Rennes (Brittany-France) with three kinds of environment (motorway, rural, and low density town center).
- In Paris (high density town center).

The diversity sounder uses broadcasted DVB-T received signals to measure channel propagation characteristics. In the north of Rennes, the receiver is set up to receive signals from the "Rennes-Saint Pern" TDF (Télédiffusion De France) transmitter. It is an MFN network with no cellular condition because only one transmitter is used in this part of country. In Paris, the receiver is set up to receive signals from the Eiffel tower transmitter.

Figure 10 shows the routes recorded by a GPS receiver used during measurements, the transmitter location, and the direction of vehicle along these routes.

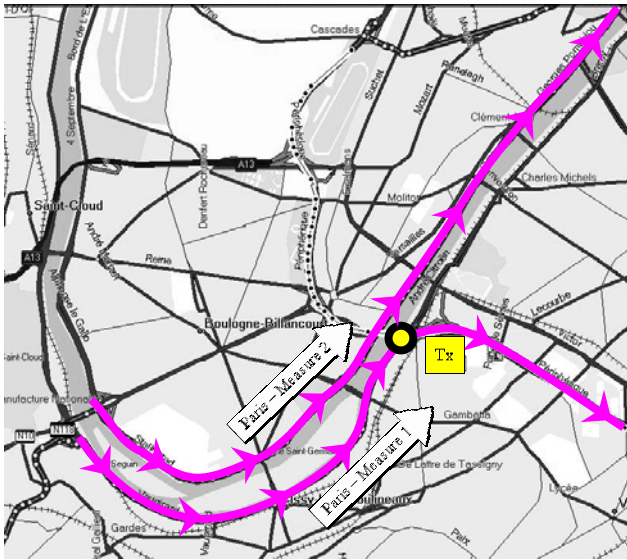

Figure 10: Route of mobile measurements recorded by the GPS receiver (Top view: Brittany (north of Rennes - Bottom view: Paris).

## 4. RESULTS OF ESTIMATION OF DOA

### 4.1. Experimental set-up

Directions of arrival are analyzed in the four cases (figure 10):

- Motorway (speed limit of 110 km/h),
- Rural area (speed limit of 90 km/h),
- Low density town center (speed limit of 50 km/h),
- High density town center (speed limit of 50 km/h).

The results are given for each method (Capon and MUSIC), with a polar histograms which show the number of redundancies that are obtained in twenty 18°-angular sectors in azimuth and elevation cut plane during each snapshot.

Figure 11 gives the reference azimuth and elevation regarding the vehicle orientation.

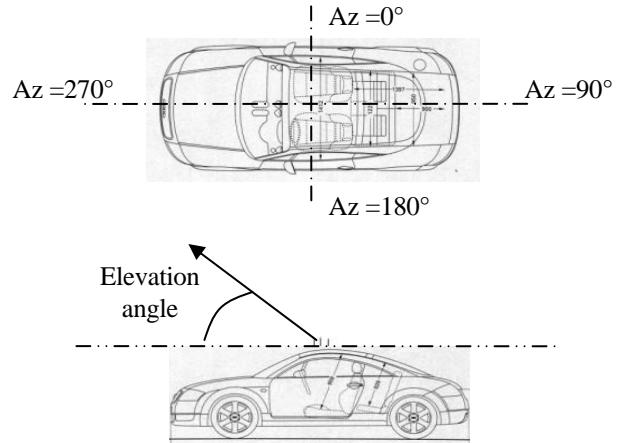

Figure 11: Car representation in azimuth and elevation plan.

### 4.2. Measurements

Figure 12 gives the AoA distribution results with Capon and Music techniques in “motorway” environment.

Figure 13 gives the goniometric distribution results with Capon and Music techniques in “rural” area.

Figure 14 gives the goniometric distribution results with Capon and Music techniques in “low density town center” environment.

Figures 15 and 16 give the direction finding distribution results with Music algorithm in “high density town center” environment. In these cases, two main angles are detected and statistical analyses are given for these both two main angles.

## 5. RESULTS COMMENTS

For measurements in the north of Rennes, the angular distribution is concentrated around the predominant Line of Site (LoS). In other cases, the demodulation is not really possible, because the signal is often shadowed, and the signal to noise ratio is too weak. The most important reflections are not seen in this diagram because they are arriving in the same mean angle of the direction. One dominant path is observed with many diffused paths around the main direction of arrival.

In this case, to have good receptions in all the azimuth space, one antenna with omni-directional radiation pattern, or several directional antennas located in each side of the vehicle can be used. Antennas must have a high radiation pattern gain to have a sufficient signal to noise ratio to demodulate COFDM signal, which is not a compatible constraint with omni-directional antenna feature, and an aperture over the 20° of elevation angle.



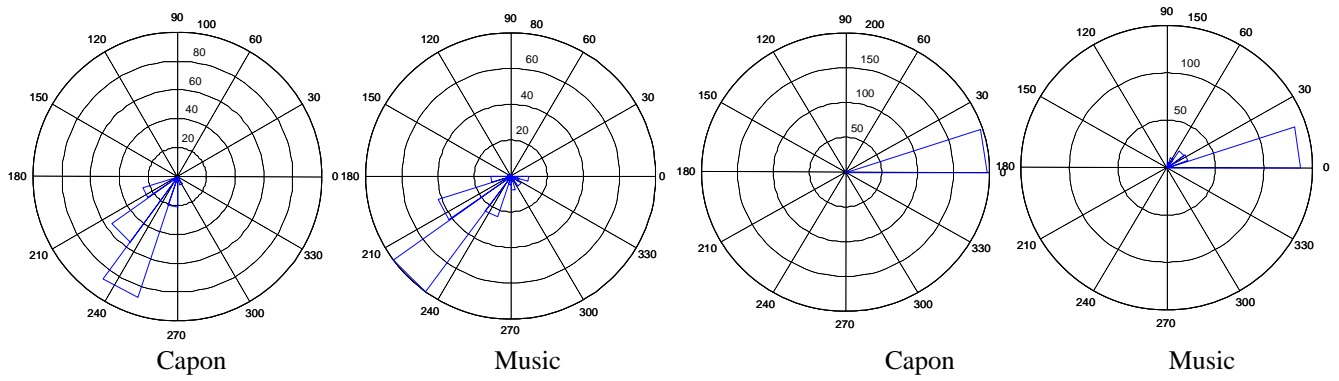

Figure 12: Azimuth and elevation analysis in motorway.

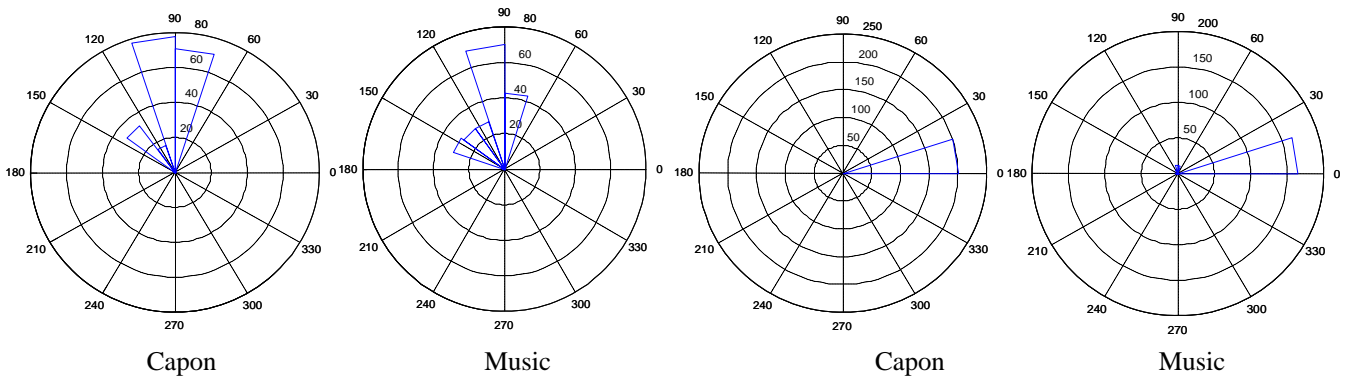

Figure 13: Azimuth and elevation analysis in rural area.

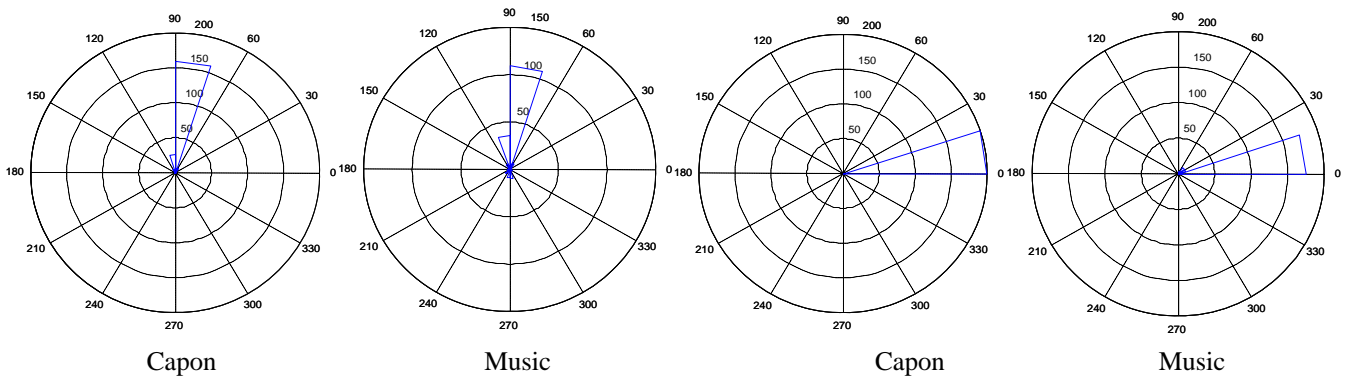

Figure 14: Azimuth and elevation analysis in low density town center.

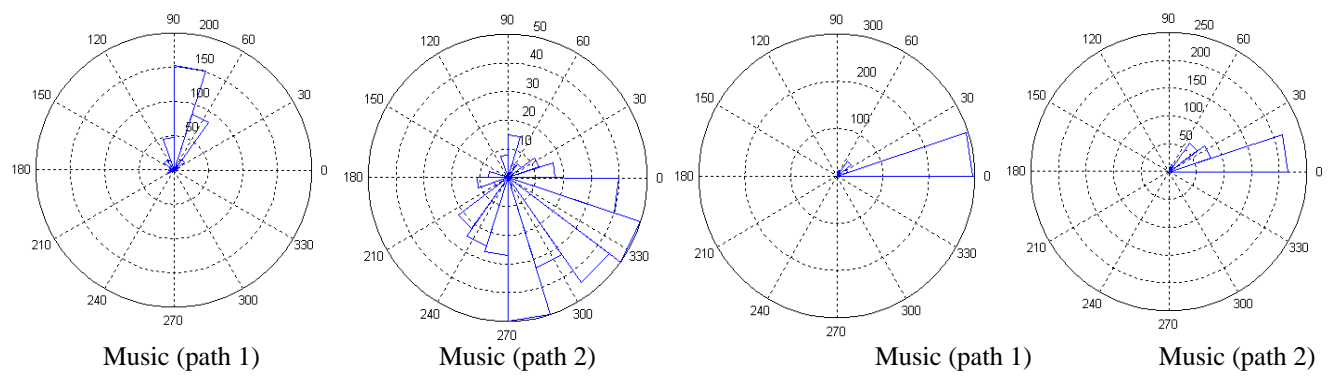

Figure 15: Azimuth and elevation analysis in Paris (measurement 1).

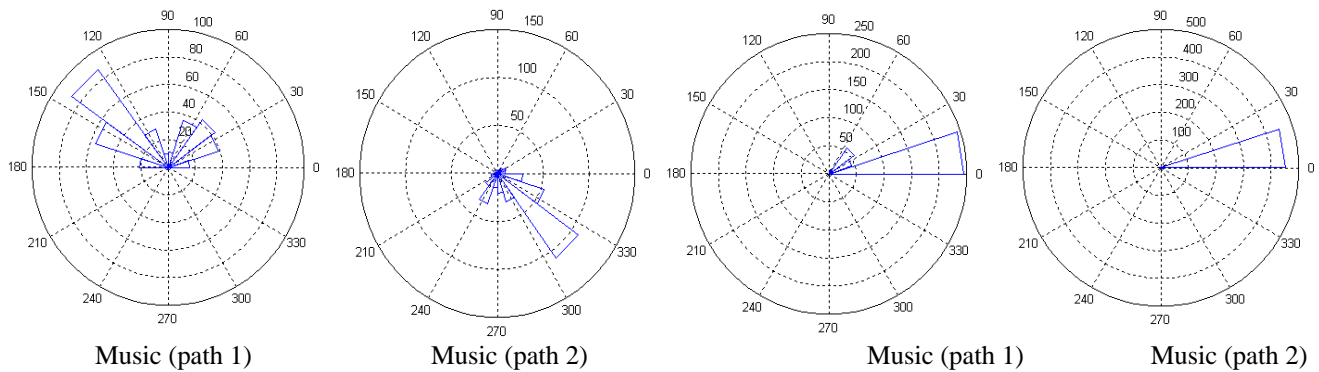

Figure 16: Azimuth and elevation analysis in Paris (measurement 2).

For measurements in Paris, two main directions of arrival have been detected. For each angle, the angular scattering is higher than in Brittany measurements. This is most likely due to the reflections and diffractions on the multiple buildings located around the street. In this configuration, the delay spreads of the paths that are generated are small. This is most likely due to the short distance of buildings contributing in multi-path phenomena. Dispersions of elevation also show the presence of diffraction over the building roof.

Omni-directional diversity array associated with MRC algorithm can offer, in these cases, a solution to improve performances.

## 6. CONCLUSION

A passive channel sounder has been developed to measure the Direction of Arrival (DoA) of DVB-T signals in mobile receiving configuration.

In high density environments like town centers, this work shows that the angular diversity is high i.e. major contributions to digital television signal are spread in all-azimuth AoA. In this case, receivers have to use MRC algorithm with omni-directional antenna.

In other environments, angular diversity is low. Thus, we can conclude that omni-directional reception can be improved by using beam forming process that can be used to have better gain in one direction and to follow the wave energy. Other solution is to use several high gain directional antennas which have to be distributed in all 360° direction. Other point is that in quad synthesizer's receiver like CAVITE system, with several distributed four antennas, the all azimuth space can be cover by antennas with aperture of 90° in azimuth. Regarding this fact, the receiver does not need to use the all four synthesizers at the same time, because waves are not distributed in the all azimuth space at a time. The consumption will be reduced but a regular scan to get quality of signal has to be done to choose the antennas which have to be used with their respective synthesizer.

## ACKNOWLEDGEMENTS

The authors thank the Council of Brittany - France (Conseil Régional de Bretagne) and the FNADT (Fonds National

d'Aménagement et de Développement du Territoire) for their supports to this project.

## REFERENCES

- [1] C. Brousseau, S. Avrillon, F. Nivole, L. Bertel, "Vectorial characterization of DVB-T propagation channel – Application to radio-Mobile communications: the "CAVITE" Project", in *Proc. EUCAP2007- 2<sup>nd</sup> European Conference on Antennas and Propagation*, Edinburgh, UK, Nov. 2007.
- [3] C. Perrine, Y. Erhel, D. Lemur, A. Bourdillon, N. Melida, "1300 km HF radio link with a 30 kbits/s data transfer rate", in *Proc. Tenth IET Conference on Ionospheric Radio Systems and Techniques*, London, UK, July 2006
- [3] Y. Erhel, D. Lemur, L. Bertel, F. Marie, "H.F. radio direction finding operating on a heterogeneous array: principles and experimental validation", *Radio-Science*, n°1, 2004.
- [4] ETSI, "Digital Video Broadcasting system for television, sound and data services: Draft ETS 300 744", March 1997.
- [5] F. Nivole, C. Brousseau, S. Avrillon, D. Lemur, F. Marie, L. Bertel, "Comparison of antennas performances for COFDM DVB-T system – Application to channel sounding", in *Proc. EUCAP2007- 2<sup>nd</sup> European Conference on Antennas and Propagation*, Edinburgh, UK, Nov. 2007.
- [6] C. W. Harrison, "Folded ddipoles and loops", *IRE Transactions on Antennas and Propagation*, 1961.
- [7] P. Combelles, C. Del Toso, D. Hepper, D. Legoff, J-J. Ma, P. Roberston, F. Scalise, L. Soyer, M. Zamboni, "A receiver architecture conforming to the OFDM based digital video broadcasting standard for terrestrial transmission (DVB-T)", in *Proc. ICC'98 - IEEE International Conference on Communications*, Torino, Italy, June 1998.
- [8] J. Capon, "Maximum-likelihood spectral estimation", Springer-Verlag, 1979.
- [9] R.O. Schmidt, "Multiple Emitter Location and Signal Parameter Estimation", *IEEE Transactions on Antennas and Propagation*, Vol. AP-34, N°3, March 1986.