



HAL
open science

HedN Game, a Relational Framework for Network Based Cooperation

Franck Delaplace, Pierre Lescanne

► **To cite this version:**

Franck Delaplace, Pierre Lescanne. HedN Game, a Relational Framework for Network Based Cooperation. 2009. hal-00382514v2

HAL Id: hal-00382514

<https://hal.science/hal-00382514v2>

Preprint submitted on 15 May 2009

HAL is a multi-disciplinary open access archive for the deposit and dissemination of scientific research documents, whether they are published or not. The documents may come from teaching and research institutions in France or abroad, or from public or private research centers.

L'archive ouverte pluridisciplinaire **HAL**, est destinée au dépôt et à la diffusion de documents scientifiques de niveau recherche, publiés ou non, émanant des établissements d'enseignement et de recherche français ou étrangers, des laboratoires publics ou privés.

HedN Game, a Relational Framework for Network Based Cooperation

F. Delaplace*

Univ. Evry Val d'Essonne, IBISC - CNRS (France)

P. Lescanne

Université de Lyon, LIP, ENS Lyon - CNRS (France)

Abstract

This paper proposes a new framework for cooperative games, providing a theoretic tool to study the behavior of players during cooperative network formation. It is based on mathematical relations. Here cooperation is defined as a supportive partnerships represented by a directed network between players (a.k.a., *hedonic relation*). We examine in a specific context, modeled by abstract games how a change of supports induces a modification of strategic interactions between players. Two levels of description are considered: the first one describes the support network formation whereas the second one models the strategic interactions between players. Both are described in a unified formalism, namely CP game. Stability conditions are stated, emphasizing the connection between these two levels. We also stress the interaction between updates of supports and their impact on the evolution of the context.

Key words: Cooperative Game, Network, Stability, Hedonic Relation -
JEL classification codes: C62, C70, C71, C88

1. Introduction

Non cooperative game theory is a broad domain with many applications. Whereas it is interesting to study fully non-cooperative games, total absence of cooperation is not complete realistic and one notices that coalitions quickly emerge in real situations, as this was noticed for long in the two main application fields, namely in conflict theory in which people use concepts like *coalition league*, *alliance*, *confederacy*, *blocs*, *axis* etc. or in economy, where one meets concepts like *guild*, *consortium*, *syndicate*, *partnership*. In this paper, we revisit, elaborate and extend mathematical concepts developed to explain and capture

*Corresponding Author

the notion of cooperation.¹ We claim that the notion of cooperation is central in setting the basis of game theory for economy as is their creation, their evolution and the consequences they have on the outcomes of the agents.

In the last two decades, cooperative game theory has been enriched by the game based network paradigm to model social organizations as a linked structure in which each link describes a pairwise interaction between players. The embedding of network theory into game theory refines the view one has of social organizations through decision making. This emphasizes the relationships between gain and social network structure. Indeed, cooperation as presented in networks is in many respects quite different from its usual formulation in cooperative game theory Von Neumann and Morgenstern (2007). This difference and the perspective it offers lead to investigate new game theoretic tools in order to analyze the structural social patterns of cooperation. This leads also to adapt to networks, game theoretic concepts associated to cooperation like characteristic functions, preferences and equilibria.

In this article, we propose a relational based framework for games on networks which lies on the hypothesis that cooperation is the result of an intricate supportive interaction, a.k.a., *hedonic relation* formalizing the cooperation viewed as a collection of supports. The supports are described as a directed network of players in which an arc that links player a to player b means: “player a supports player b ”.

A model of cooperation, of its evolution and of transfer. In what follows, we investigate the emergence of supports of agents for others. Their aim is to improve their utility in a certain context which we represent as a game which evolves with the evolution of supports. Such supports and their consequences are good models of micro-economic situations or social interactions. The framework is then designed around two concepts of games: this of *context game* and this of *relational hedonic game*. The former defines the relations between the capacities and the expectations of players; and the latter, called also *HedN game*, describes the evolution of the hedonic relation. This enables us to expose how the relations of support act on the interactions and conversely how the context affects the relations of cooperation, in particular their stability.

More precisely, context games interpret formally the support as a *transfer of preferences* to supported players leading to adapt their decision to the expectations of the others. Therefore, the whole context (game) changes because preferences are updated by player actions, which makes it to evolve due to the supports of players to others. The strategic interactions of players in the context game are defined abstractly using a network based structure which coalesces the preference and the feasibility of actions of the players.

At a more abstract level, *HedN games* model the evolution of the supports through deviations of hedonic relations represented by a network. A direct arc

¹Indeed among the many available terms we have chosen the word *cooperation*, following the tradition.

between two hedonic relations represents a deviation toward a new partnership.

It is worth noticing that both levels of description, namely, context game and HedN game, use the same network based game formalism (a.k.a., CP games).

HedN game is closed to two game-theoretic fields, namely: this of hedonic games and this of network formation games. Before setting up the scope of our work, we review related works on hedonic games and network games, catching only a glimpse of a fast-growing literature.

Hedonic Games. After pioneer works by Dreze and Greenberg (1980) in the context of public goods production, hedonic games were formally studied by Bogomolnaia and Jackson (2002) and Banerjee et al. (2001). A hedonic game grounds the stability of a set of agents on individual preferences which depend only on the coalition of agents it contains. In Ballester (2004) the author analyses the complexity of computing hedonic stability and proves it is NP-complete. Sung and Dimitrov (2007) look at several form of stability concepts through a taxonomy of their decomposition into primitive concepts, and then focus on how stability can be derived from those primitive concepts.

Two sorts of deviations are considered: individual and collective. By deviation we mean a change of a player partition on a predefined organization of players called a *coalition structure*. Informally, the potential deviations toward a preferred coalition are of four sorts: *Core deviation*: players can freely assemble whatever the initial coalition structure is; *Nash deviation*: a player may individually join another coalition inside the coalition structure provided she finds this more profitable; *Individual deviation*: to individually join another coalition of the coalition structure a player must be welcomed unanimously; and *Contractual Individual deviation*: to individually leave a coalition the departure of the player must be accepted unanimously. The deviation conditions will be formally defined in the scope of hedonic relations in Section 4.

Network formation games. The network formation games were established by the seminal works of Myerson (1991); in them, a cooperation is viewed as a preferential interaction between agents, through preferential links, where agents can freely choose and change their links. The networks model social ties, trade exchanges, collusive alliances, and more generally any social interaction based on a mutual consent. Therefore, some game-theoretic objects, namely characteristic functions, utility functions and allocation rules, have been purposely redrawn to account for network configurations. Most of the works relies on undirected networks to figure the underlying symmetry of the mutual consent. The literature has been recently surveyed in Jackson (2005); van den Nouweland (2005).

The concept of network stability addresses on the one hand allocation policy and on the other hand network formation with respect to a connection policy. In Myerson (1991) agents announce which agent they wish to connect by a link. A link is formed if both agents agree. Standard game-theoretic equilibria are used to make predictions. Jackson and Wolinsky (1996) propose the concept of *pairwise stability* for social networks. Informally, a pairwise deviation implies

that both agents in a pair improve their outcome. In Jackson and van den Nouweland (2005), a stronger condition extends the pairwise stability by enabling connected pairwise creations and deletions. Agents carry out a deviation if the new connection configuration is profitable for the whole group (with respect to the allocation rule). The authors investigate conditions for *strongly stable* networks which they apply to convex games. A comparison of the main concepts of stability can be found in Bloch and Jackson (2007) showing their relation, and their differences.

HedN game sets a relational algebraic framework that aims at understanding network formation based on supports, leading to coalition formation, as in network game formation and hedonic game. By contrast, in HedN game, the evaluation of the modification of the supports/links formation is based on a context. Stability condition of a hedonic relation will be addressed at two levels of description: at the level of context game and at the level of HedN game. For instance, it exhibits an unexpected but sensible cooperative behavior consisting in accumulating potential issues that increase the possibilities of choices for players. Moreover HedN game introduces different solution concepts to evaluate the stability of the supports relation. These solutions concepts are inherited to Hedonic game (Nash, Core, Individual,...). The different concepts of stability are actually refinements of a generic concept of Nash-like equilibrium, called *the relational abstract Nash equilibrium*.

The paper is organized as follows: Section 2 details Conversion Preference games (CP games) which is a relation based algebraic framework proposed by Le Roux et al. (2006). Informally, decision making results in the matching of feasible actions of the agents and their desire which are both modeled as mathematical relations between game situations. CP games are used to define both context games and HedN games. Section 3 defines the principles of hedonic relations. The notion of coalitions, transfer and improvement with respect to a game context are formally defined. Section 4 investigates the cooperation design problem based on HedN game. Section 5 determines stability conditions for HedN games.

Most of the results are based on relational algebra whose most properties and definitions are presented in Appendix (*cf.* Table 6).

2. Conversion Preference Game

This section summarizes the essential of CP game theory, a theory which was proposed by Le Roux et al. (2006) (*cf.* also Lescanne (2006) for a tutorial) as an algebraic framework for non-cooperative games. CP games make the notion of relation/interaction central, like in social networks, biological networks, Internet, etc. For instance, CP games have been successfully applied to biological networks to model the dynamic of genetic regulatory networks in Chettaoui et al. (2006) and metabolic networks in Senachak et al. (2007) to predict molecular signatures of cellular phenotypes that correspond to CP equilibria.

Two kinds of equilibria are defined: the static ones extend strictly traditional pure Nash equilibria in strategic games, and the dynamic ones are discrete and

generalize classical Nash equilibria to sets of situations. Informally CP games address the three basic questions of choice mentioned in the introduction of Rubinstein (2006) book: 1. What is desirable? 2. What is feasible? 3. How to choose the most desirable among the feasible? These questions are formally defined by relations on situations, namely *conversion* for feasibility, *preference* for desirability and *change of mind* for feasible desires. The later is the intersection of conversion and preference.

2.1. CP Game Definition

Formally a CP game is defined as follows.

Definition 1 (CP Game). A CP game is a 4-uple $\langle \mathcal{N}, S, (--\rightarrow_a)_{a \in \mathcal{N}}, (\cdots \rightarrow_a)_{a \in \mathcal{N}} \rangle$ where:

- \mathcal{N} is a set of *players* or agents;
- S is a set of *situations* or outcomes;
- for $a \in \mathcal{N}$, $--\rightarrow_a \subseteq S \times S$ is the *conversion* of player a ;
- for $a \in \mathcal{N}$, $\cdots \rightarrow_a \subseteq S \times S$ is the *preference* of player a .

When \mathcal{N} and S are known we write only $\langle (--\rightarrow_a)_{a \in \mathcal{N}}, (\cdots \rightarrow_a)_{a \in \mathcal{N}} \rangle$, showing clearly that for \mathcal{N} and S fixed, a game is an element of the set $(\mathbf{2}^{S \times S} \times \mathbf{2}^{S \times S})^{\mathcal{N}}$.

CP games can be illustrated by strategic games, but of course they catch a wider spectrum of models of game theory. A strategic game can be encoded into a CP game as follows:

Definition 2 (From Strategic Games to CP Games).

Let $G = \langle \mathcal{N}, (C_a)_{a \in \mathcal{N}}, (u_a)_{a \in \mathcal{N}} \rangle$ be a strategic game where \mathcal{N} is a set of agents, C_a is the set of strategies for player a and u_a is the utility function for player a ; we define the equivalent CP game $\Gamma = \langle \mathcal{N}, S, (--\rightarrow_a)_{a \in \mathcal{N}}, (\cdots \rightarrow_a)_{a \in \mathcal{N}} \rangle$ as follows:

- $S = \times_{a \in \mathcal{N}} C_a$, each situation is a n -Cartesian product (where n is the number of players), namely a strategy profile;
- $(s_a, s_{-a}) --\rightarrow_a (s'_a, s_{-a}) \Leftrightarrow s_a \neq s'_a$, a player can convert a situation to another, *i.e.*, a profile to another; the new profile is the same as the current one except for the strategy of the player.
- $s \cdots \rightarrow_a s' \Leftrightarrow u_a(s) \leq u_a(s')$, the preference is an order on profiles based on the utility function of each player; a player prefers a situation which increases her outcome.

Example 1 (Prisoner's Dilemma). The *strategic game* for Prisoner's Dilemma is defined as follows:

- players are: $\mathcal{N} = \{\mathbf{1}, \mathbf{2}\}$;

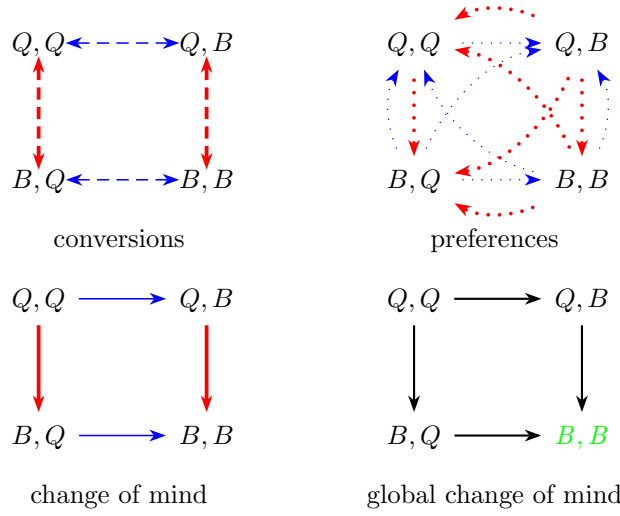

Red bold arrows correspond to player 1 conversions and preferences; blue thin arrows to player 2. Preferences and conversions are distinct relations. The change-of-mind symbolizes the feasible desires.

Figure 1: Prisoners' Dilemma CP Game

- strategies are: $(\{B, Q\}, \{B, Q\})$ with B =Betray, Q =Stay Quiet/Silent;
- utility function u is defined as the opposite of the year sentences:

	B	Q
B	$-2, -2$	$0, -10$
Q	$-10, 0$	$-0.5, -0.5$

The *CP game of prisoners dilemma* is defined as follows:

- $\mathcal{N} = \{1, 2\}$;
- $S = \{(B, B), (B, Q), (Q, B), (Q, Q)\}$;
- Conversions expresses the ability to change his strategy and preference tells how an agent compares situations. They are graphically described in Figure 1. For instance, player 1 reciprocally converts situations $(B, Q), (Q, Q)$ (*i.e.*, $(B, Q) \dashrightarrow_1 (Q, Q), (Q, Q) \dashrightarrow_1 (B, Q)$) that corresponds to the change of her strategy. Moreover, she prefers (B, Q) to (Q, Q) (*i.e.*, $(B, Q) \cdots_1 (Q, Q)$) but also (Q, Q) to (B, B) (*i.e.*, $(Q, Q) \cdots_1 (B, B)$). However this preference does not coincide with any conversion.

From conversions and preferences, we introduce new relations which define the *enabled preferences* when players want to and are able to change a situation to another. Those relations are called *changes of mind*.

Definition 3 (change of mind). The *change of mind* of player a and the *global change of mind* are:

$$\rightarrow_a \triangleq \neg\neg\rightarrow_a \cap \dots\rightarrow_a \qquad \Gamma \triangleq \bigcup_{a \in \mathcal{N}} \rightarrow_a$$

Example 2 (Prisoner’s Dilemma change of mind). See the lower part graph of Figure 1.

2.2. CP Equilibrium

There are two notions of equilibrium, where the first one is an instance of the second: the first notion corresponds to a *stable consensus* on a single situation, namely all the players agree on a game situation and do not want to change it. This kind of equilibrium is called an *abstract Nash equilibrium* and extends strictly the traditional pure Nash equilibrium in strategic games (*cf.* Le Roux et al. (2006) for the proof).

The second notion, called *CP equilibrium*, corresponds to a subset (a cluster) of situations deemed equivalent by players with regard to change of mind. A CP equilibrium represents a set of situations which are all “better” than the other reachable situations. Hence, the players want neither to leave the cluster nor to select specifically one situation in it, that is to say that players can only move from one situation to another in the same cluster. Figure 3 describes an example where both types of equilibrium occur.

A player who has no incentive to leave a situation where she lies is said to be *happy* with the situation. Therefore, *a situation is an abstract Nash equilibrium if every player is happy with it*. This leads to the formal following definition of Abstract and CP equilibria:

Definition 4 (Abstract Nash equilibrium).

A situation s in a game $\Gamma = \langle \mathcal{N}, S, (\neg\neg\rightarrow_a)_{a \in \mathcal{N}}, (\dots\rightarrow_a)_{a \in \mathcal{N}} \rangle$ is an abstract Nash equilibrium, written $\text{AN}_\Gamma(s)$, if and only if:

$$\text{AN}_\Gamma(s) \triangleq \forall a \in \mathcal{N}, \forall s' \in S. s \neg\neg\rightarrow_a s' \wedge s \dots\rightarrow_a s' \implies s = s'$$

In other words, $\text{AN}_\Gamma(s) \triangleq \forall s' \in S. s \rightarrow s' \implies s = s'$. Such a situation is called a *sink* for \rightarrow .

Example 3. There is one and only one abstract Nash equilibrium in Prisoner’s Dilemma (Example 1) namely (B, B) (see also Figure 1).

Definition 5 (CP Equilibrium). Let $\Gamma = \langle \mathcal{N}, S, (\neg\neg\rightarrow_a)_{a \in \mathcal{N}}, (\dots\rightarrow_a)_{a \in \mathcal{N}} \rangle$ be a game and $\lfloor s \rfloor_\Gamma$ be a cluster of situations defined as follows: $\lfloor s \rfloor_\Gamma \triangleq \{s' \in S \mid s \rightarrow^* s' \wedge s' \rightarrow^* s\}$. $\lfloor s \rfloor_\Gamma$ is a *CP equilibrium*, written $\text{CP}_\Gamma(\lfloor s \rfloor_\Gamma)$, if:

$$\text{CP}_\Gamma(\lfloor s \rfloor_\Gamma) \triangleq \text{AN}_{\lfloor \Gamma \rfloor}(\lfloor s \rfloor_\Gamma)$$

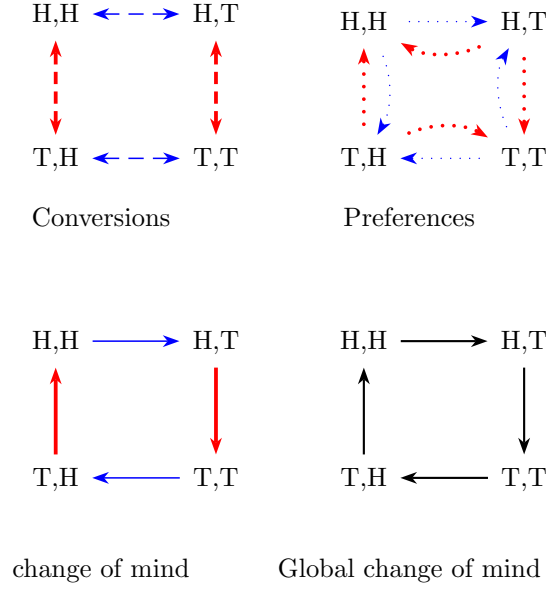

Figure 2: Matching pennies CP Game

where the *reduced game* is $[\Gamma] \triangleq \langle \mathcal{N}, [S]_{\Gamma}, ([\rightarrow_a]_{\Gamma})_{a \in \mathcal{N}}, ([\rightarrow_a]_{\Gamma})_{a \in \mathcal{N}} \rangle$; and $[\rightarrow_a]_{\Gamma}$ stands for the *quotient relation*² of the relation \rightarrow_a .

Remark 1. A class of situations, $[s]_{\Gamma}$, corresponds to a strongly connected component³ of the global change of mind (\rightarrow) graph. A CP equilibrium is a sink in the reduced graph of the relation $[\rightarrow]_{\Gamma}$ corresponding to a terminal strongly component in the initial (\rightarrow) graph, (see Figure 3).

Example 4 (Matching Pennies). Figure 2 represents the conversion, preference and change-of-mind of the matching pennies game. H stands for Head and T for Tails. If pennies match then player 1 wins else player 2 wins (pennies mismatch).

Note that abstract Nash equilibria can be seen as specific CP equilibria, namely singleton CP equilibria as expressed by the following proposition:

Proposition 1. $AN_{\Gamma}(s) \Leftrightarrow CP_{\Gamma}(\{s\})$

²Let $\rightarrow \subseteq S \times S$ be a relation and let $[S]$ be a partition of S , the quotient relation $[\rightarrow]$ is defined as follows: $[s][\rightarrow][s'] \triangleq [s] \neq [s'] \wedge \exists s_1 \in [s], \exists s_2 \in [s']. s_1 \rightarrow s_2$

³In a directed graph, a strongly connected component (SCC) is a maximal set under inclusion of vertices connected to each other by directed paths. An $\mathcal{O}(|S|^2)$ complexity algorithm to compute SCC's is due to Tarjan (1972).

Example 5. The example describes a bargaining over the price of an item leading to a CP equilibrium due to the myopic strategy of the seller. The price of the item is initially fixed to 4. The buyer and the seller freely modify their offer. The buyer is willing to pay at most the half of the initial price (*i.e.*, 2) and the seller will not accept less than the half of the price (*i.e.*, 2). When the seller sees that the buyer refuses to increase his offer after two successive discounts, she decides to start again the bargaining at the initial price, 4. Moreover, to incite the buyer to increase his offer, she augments the price when the difference between the offers is reduced to 1. Situations correspond to seller/buyer offers ($S = [2, 4] \times [0, 2]$); conversions describe the variations of offers; and preferences, the admissible evolution of offers that players concede to conclude the transaction; thus restricting the variation of offers to 1 unit. The CP Game converges into two equilibria: either an abstract Nash equilibrium figuring the end of the bargain, (2, 2), or a CP equilibrium $\{(4, 2), (3, 2)\}$ corresponding to an endless change of the selling price justified by the strategy of the seller when the buyer reaches his highest offer, 2. Figure 3 depicts the change of mind and the quotient change of mind graphs.

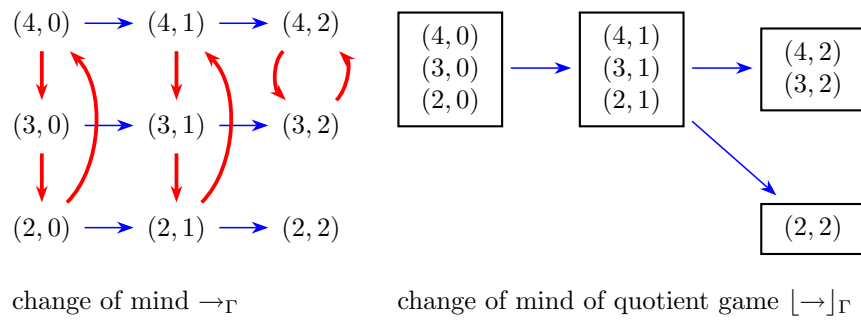

Vertical change of minds correspond to the **seller** and horizontal ones to the **buyer**.

Figure 3: Change of mind of the bargaining game and the associated quotient graph.

3. Hedonic Relation

Hedonic coalitions were formally defined by Bogomolnaia and Jackson (2002) to describe coalitions in hedonic games. We present here an abstract framework based on CP games for supportive relation which can be considered at the cross-roads of hedonic games and game network formations.

A *hedonic relation* or a *cooperation* is a *total*⁴ relation among players, with the intended meaning that if \mathcal{C} is such a relation $a\mathcal{C}b$ means “ a supports b ”. The set of all hedonic relations is denoted by $\mathbb{H}_{\mathcal{N}}$ (i.e., $\mathbb{H}_{\mathcal{N}} = \{\mathcal{C} \in \mathbf{2}^{\mathcal{N} \times \mathcal{N}} \mid \bigcup_{a \in \mathcal{N}} \mathcal{C}a = \mathcal{N}\}$). The cardinality of $\mathbb{H}_{\mathcal{N}}$ is $(2^n - 1)^n$ where n is the number of players. The set of *players supported* by a is the image of a by \mathcal{C} , written $a\mathcal{C}$ and the set of *supporters* of b is the preimage of b by \mathcal{C} written $\mathcal{C}b$. Given a hedonic relation \mathcal{C} , a player a is *selfish* if $a\mathcal{C}a$ and she is *altruistic* if $\exists b \in \mathcal{N}, b \neq a \wedge a\mathcal{C}b$. The cooperation $\mathcal{I} : \{(a, a) \mid a \in \mathcal{N}\}$ is the identity relation⁵ in this framework; we call it the *pure selfish cooperation*. The cooperation $\mathcal{U} = \mathcal{N} \times \mathcal{N}$ is the universal cooperation where anybody supports everybody.

\mathcal{I}	=	{(1, 1), (2, 2)}	}	(S, S)
\mathcal{C}_1	=	{(1, 2), (2, 1)}	}	(A, A)
\mathcal{C}_2	=	{(1, 1), (2, 1)}	}	(S, A)
\mathcal{C}_3	=	{(1, 2), (2, 2)}	}	(A, S)
\mathcal{C}_4	=	{(1, 1), (1, 2), (2, 1)}	}	(AS, A)
\mathcal{C}_5	=	{(1, 2), (2, 1), (2, 2)}	}	(A, AS)
\mathcal{C}_6	=	{(1, 1), (2, 1), (2, 2)}	}	(S, AS)
\mathcal{C}_7	=	{(1, 1), (1, 2), (2, 2)}	}	(AS, S)
\mathcal{U}	=	{(1, 1), (1, 2), (2, 1), (2, 2)}	}	(AS, AS)

\mathcal{I} is the *identity relation* and \mathcal{U} is the *universal relation*. The behavior of players ($A = \text{Altruism}$, $S = \text{Selfishness}$) are described on the right hand side of the list of hedonic relations.

Table 1: Hedonic relations between two players

Example 6 (Cooperation among two players). For two players there are nine possible cooperations (cf. Table 3). In \mathcal{I} , both agents are selfish whereas, in \mathcal{C}_1 , both are altruistic. \mathcal{C}_2 models a situation where player 2 is altruistic whereas player 1 remains selfish.

Recall that $\tilde{\mathcal{C}}$ is the symmetric closure of \mathcal{C} (i.e., $a\tilde{\mathcal{C}}b \Leftrightarrow a\mathcal{C}b \vee b\mathcal{C}a$) and $\tilde{\mathcal{C}}^*$ is the symmetric, reflexive and transitive closure of \mathcal{C} . Classically, a cooperation is used to specify *coalitions* which represent cooperators meeting in leagues. They are deduced from the hedonic relation as follows:

⁴A relation is *total* if and only if $\forall a \in \mathcal{N}, \exists b \in \mathcal{N}. a\mathcal{C}b$. Thus, any player supports somebody possibly herself only.

⁵The relation is also known as *equality*.

Definition 6 (Coalition). Given a hedonic relation \mathcal{C} on \mathcal{N} , $C \subseteq \mathcal{N}$ is a coalition induced by \mathcal{C} , if it is a maximal set of players connected by \mathcal{C} , *i.e.*,

$$\forall a \in \mathcal{N}, \forall b \in \mathcal{N}, a \in C \Rightarrow (a \tilde{\mathcal{C}}^* b \Leftrightarrow b \in C).$$

Remark 2. In other words, a coalition is a weakly connected component⁶ of the hedonic relation graph. Definition 6 is actually an adaptation to relations of Jackson and van den Nouweland's definition Jackson and van den Nouweland (2005).

Example 7. The coalitions associated with the cooperations of (Example 6) are: $\{\{1\}, \{2\}\}$ for the relation \mathcal{I} because $\tilde{\mathcal{I}}^* = \mathcal{I}$ and $\{\{1, 2\}\}$ for the others because $\tilde{\mathcal{C}}_i^* = \mathcal{U} = \tilde{\mathcal{U}}^*, 1 \leq i \leq 7$.

$\Pi_{\mathcal{C}}$ is the *coalition structure* which is a partition⁷ and which we call also the *coalition partition*. The class of a for $\Pi_{\mathcal{C}}$ is written $\Pi_{\mathcal{C}}(a)$. Note that different cooperations may share the same coalition structure (Example 7).

Definition 7. $\Pi_{\mathcal{C}}(a) = a \tilde{\mathcal{C}}^* = \tilde{\mathcal{C}}^* a$ is the coalition which a belongs to. It is unique.

3.1. Transfer

After having introduced the abstract framework of hedonic relations, let us instantiate them in CP games. Supporting involves a *transfer of preferences* described by a hedonic relation yielding a *cooperative game*. A *transfer* is a function on games produced by a hedonic relation.

Definition 8 (Transfer). Let $\mathbb{G}_{\mathcal{N}, S} = (\mathbf{2}^{S \times S} \times \mathbf{2}^{S \times S})^{\mathcal{N}}$ be the set of CP games defined on a set \mathcal{N} of agents and a set S of situations. **Trans**₋ is a function called *transfer*:

$$\mathbf{Trans}_- : \mathbb{H}_{\mathcal{N}} \rightarrow \mathbb{G}_{\mathcal{N}, S} \rightarrow \mathbb{G}_{\mathcal{N}, S}$$

where:

$$\mathbf{Trans}_{\mathcal{C}} \langle (\dashrightarrow_a)_{a \in \mathcal{N}}, (\cdots \rightarrow_a)_{a \in \mathcal{N}} \rangle = \langle (\dashrightarrow_a)_{a \in \mathcal{N}}, \left(\bigcup_{b \in a \mathcal{C}} \cdots \rightarrow b \right)_{a \in \mathcal{N}} \rangle$$

A transfer leaves the conversion untouched and changes the preference using \mathcal{C} . Given a CP game Γ , the games **Trans** _{\mathcal{C}} (Γ) when \mathcal{C} traverses the set of hedonic relations are called *cooperative games*.

Example 8 (Equilibria of cooperative game for Prisoner's dilemmas). Figure 4 shows how the change of mind is modified to yield the transfer deduced from cooperations given in Example 6 for Prisoners' dilemmas. The CP equilibria of the cooperative games are described in Table 2.

\mathcal{I}	$\{(B, B)$	$\}$
\mathcal{C}_1	$\{(Q, Q)$	$\}$
\mathcal{C}_2	$\{(B, Q)$	$\}$
\mathcal{C}_3	$\{(Q, B)$	$\}$
\mathcal{C}_4	$\{(B, Q), (Q, Q)$	$\}$
\mathcal{C}_5	$\{(Q, B), (Q, Q)$	$\}$
\mathcal{C}_6	$\{(B, Q), (B, B)$	$\}$
\mathcal{C}_7	$\{(Q, B), (B, B)$	$\}$
\mathcal{U}	$\{(B, B), (B, Q), (Q, Q), (Q, B)\}$	$\}$

Table 2: equilibria of cooperative prisoners' dilemmas games for two players cooperation.

An important property of a hedonic relation is its *effectiveness*. Effectiveness checks whether the cooperation produces an effect on the cooperative game. For instance, assume the conversion of a supporter nowhere fits with the player preference with whom she cooperates. In other words, the supporter is unable to agree with the player preferences on any situation, even though the support is asserted; we say tha the support is ineffective. In contrast, an *effective cooperation* presumes that the conversion of the supporter fits somewhere with the preference of the supported player; the transfer is therefore effective.

Definition 9 (Effective Hedonic Relation). Let Γ be a game, let \mathcal{C} be a cooperation, \mathcal{C} is *effective* if and only if:

$$\text{Effective}_{\Gamma}(\mathcal{C}) \triangleq \forall a \in \mathcal{N}, \forall b \in \mathcal{N}. a \mathcal{C} b \implies \dashrightarrow_a \cap \dashrightarrow_b \neq \emptyset$$

In the above examples of CP games (prisoner's dilemma and matching pennies), we have: $\dashrightarrow_1 \cap \dashrightarrow_1 \neq \emptyset, \dashrightarrow_2 \cap \dashrightarrow_2 \neq \emptyset, \dashrightarrow_1 \cap \dashrightarrow_2 \neq \emptyset$, and $\dashrightarrow_2 \cap \dashrightarrow_1 \neq \emptyset$. Hence one can build only effective hedonic relations. In Example 5, a cooperation \mathcal{C} with $1\mathcal{C}2$ or $2\mathcal{C}1$ cannot be effective.

3.2. Improvement

A rational cooperative commitment requires to evaluate and compare several potential cooperations to choose an optimal one. For instance the case of prisoners' dilemma, \mathcal{C}_2 , where player 2 is altruistic and player 1 is selfish, leads to a situation which appears to be the worst for player 2 (*cf.* Example 6 and Figure 4). The *cooperation improvement* is a partial order among cooperations based on comparisons between game equilibria.

A weak notion of the improvement is expressed in Definition 10. It captures the expectation of a better profit for the cooperating players which appears to

⁶A weakly connected component of a directed graph is a maximal set of vertices that are mutually reachable no matter the direction the edges.

⁷A *partition* Π of a set \mathcal{N} is a set of non empty pairwise disjoint subsets of \mathcal{N} whose union is \mathcal{N} , in other words: $\forall P \in \Pi, \forall P' \in \Pi. (P \cap P' \neq \emptyset \Leftrightarrow P = P') \wedge \mathcal{N} = \bigcup_{P \in \Pi} P$.

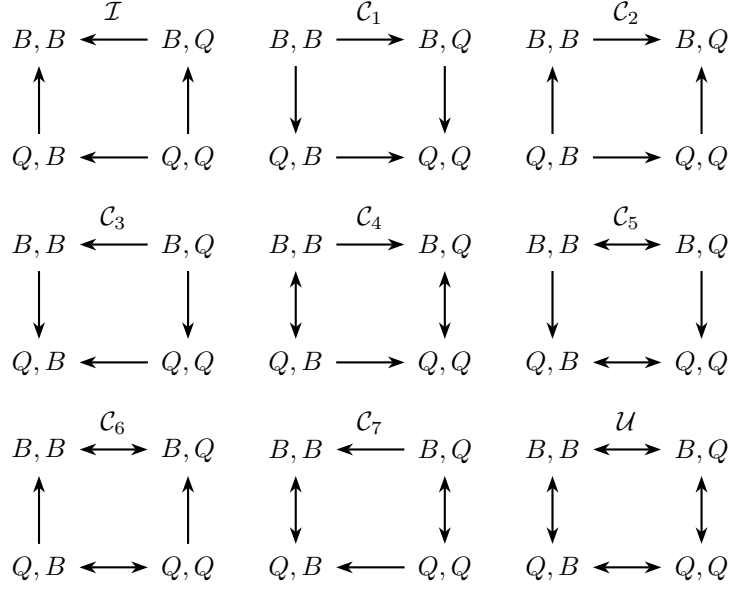

Figure 4: Changes of mind of the cooperative games for Prisoners' Dilemma

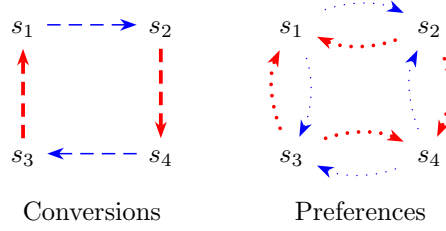

Figure 5: A CP game with a non effective hedonic relation

be the usual motivation for cooperating decision makers. For instance, with no surprise, players prefer (Q, Q) to (B, B) even in an equilibrium which contains another situation, like (Q, B) or (B, Q) (*cf.* Figure 6 and Table 2). The improvement is first defined on players and then extended to sets of players.

Definition 10 (Cooperation Improvement). The *cooperation improvement* is defined as an order between cooperations:

$$\mathcal{C}_1 \preceq_a^\Gamma \mathcal{C}_2 \triangleq \forall s \in S, \text{CP}_{\Gamma_1}(\lfloor s \rfloor_{\Gamma_1}) \Rightarrow (\exists s' \in S, \text{CP}_{\Gamma_2}(\lfloor s' \rfloor_{\Gamma_2}) \Longrightarrow s \cdots \rightarrow_a^* s')$$

where Γ_1 stands for $\mathbf{Trans}_{\mathcal{C}_1}(\Gamma)$ and Γ_2 stands for $\mathbf{Trans}_{\mathcal{C}_2}(\Gamma)$. The improve-

ment extends to a set of players $A \subseteq \mathcal{N}$ as follows⁸:

$$\preceq_A^\Gamma \triangleq \bigcap_{a \in A} \preceq_a^\Gamma \quad \prec_A^\Gamma \triangleq \preceq_A^\Gamma \cap \neq$$

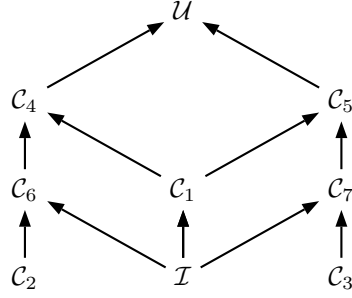

Figure 6: The collective improvement lattice for prisoners' dilemma ($\preceq_{\{1,2\}}^\Gamma$).

Notice that the comparison between hedonic relations is established with respect to the preferences of the initial context game, whereas the equilibria are considered in new games with the new transferred preferences. Indeed, the idea behind this is that players expect to find the best improvement of an initial context game by comparing several potential hedonic relations. Therefore, comparisons address the rational incentives to cooperate. Thereby, the initial context game is a common referential for comparison.

A special attention is paid to the evolution of cooperations which preserve the equilibria because they are always improvements. Intuitively, improvements offer new situations where everyone is happy while preserving those where everyone was already happy.

Example 9. In prisoners' dilemma, cooperation $\mathcal{I}, \mathcal{C}_6, \mathcal{C}_7, \mathcal{U}$ preserve equilibria whereas cooperations $\mathcal{C}_1, \mathcal{C}_2, \mathcal{C}_3, \mathcal{C}_4, \mathcal{C}_5$ do not preserve them.

Proposition 2. Let Γ be a game, let $\mathcal{C}_1, \mathcal{C}_2$ be two hedonic relations, let Γ_1 be $\mathbf{Trans}_{\mathcal{C}_1}(\Gamma)$ and Γ_2 be $\mathbf{Trans}_{\mathcal{C}_2}(\Gamma)$, if $\mathbf{CP}_{\Gamma_1}(\lfloor s_1 \rfloor_{\Gamma_1})$ and $\mathbf{CP}_{\Gamma_2}(\lfloor s_2 \rfloor_{\Gamma_2})$ imply $\lfloor s_1 \rfloor_{\Gamma_1} \subseteq \lfloor s_2 \rfloor_{\Gamma_2}$ then $\mathcal{C}_1 \preceq^\Gamma \mathcal{C}_2$.

Remark 3. Cooperations which *preserve equilibria*, are denoted by $\mathbf{Preserv}_\Gamma(\mathcal{C})$,

4. Hedonic Relation Game

When designing a cooperation, one aims at finding a hedonic relation yielding a transfer of preferences on a game which improves the happiness of players.

⁸In the rest of the paper Γ will be omitted in no ambiguity occurs.

Usually, this turns out to be hard. To figure out its computational hardness, we first focus on a hedonic relation which leads to the grand coalition⁹. *In general, finding a cooperation which makes everybody happier is intractable* (Theorem 1).

Therefore, the practical search for universal happiness, *i.e.*, for a cooperation which makes all the agents happier has to rely on heuristics. This may be the reason why in the real world, optimizing cooperation is governed by fair practices. In order to provide some insights on social practices in cooperation we propose a framework, called HedN game, where several concepts can be declined, especially *stability*.

Cooperation evolves toward stability. By definition, stability of a cooperation comes from a comparison with “neighbors” (*i.e.*, its immediately reachable cooperations) which depends on the intentions of players. Hence to address stability we have to address neighborhood and improvement.

Definition 11 (Quest for the Grand Coalition).

INSTANCE: a game Γ .

QUESTION: Does there exist an effective cooperation \mathcal{C} whose partition structure is that of the grand coalition for \mathcal{N} and which improves \mathcal{I} ? Formally:

$$\exists \mathcal{C} \in \mathbb{H}_{\mathcal{N}}. \mathcal{I} \preceq_{\mathcal{N}}^{\Gamma} \mathcal{C} \wedge \Pi_{\mathcal{C}} = \{\mathcal{N}\} \wedge \text{Effective}_{\Gamma}(\mathcal{C}).$$

The Quest for the Grand Coalition is abbreviated as QGC

Theorem 1. *QGC is NP-Complete.*

PROOF. *By reduction to the Hamiltonian path problem. (cf. Appendix)*

4.1. Definition of Hedonic Relation Games

In a hedonic relation game, deviation proceeds into two ways: acknowledging the current supports and initiating new supports; in other words there are two possible actions: either the player quits her coalition to join another or the player reconsiders the support she gives to her cooperators. Only the first action is addressed in traditional coalitional and hedonic game theory (*cf.* Examples 7 and 8).

We distinguish the ability to complete a deviation from the incentive to perform it. Traditionally the term deviation refers only to the completion whereas the *improvement* which compares the change of mind of the HedN game seems to be important as well. This identifies which groups of players can update the cooperation. Hence, the characterization of a *deviation neighborhood* lies on the characterization of the set of players whose cooperative interactions may change. Two cooperations are neighbors with respect to a group of players if removing this group makes them the same. The *deviation* which allows defining neighbors is an equivalence relation, *i.e.*, symmetric transitive and reflexive.

⁹The *grand coalition* is the only coalition that meets all the players.

Definition 12 (Deviation). Given \mathcal{N} and $A \subseteq \mathcal{N}$, a *deviation* \succsim_A is a subset of $\mathcal{N}^2 \times \mathcal{N}^2$ such that

$$\mathcal{C} \succsim_A \mathcal{C}' \quad \text{iff} \quad \mathcal{C} \cap (\bar{A} \times \bar{A}) = \mathcal{C}' \cap (\bar{A} \times \bar{A})$$

where \bar{A} is the complement of A in \mathcal{N} ;

The *deviation neighborhood* of \mathcal{C} is the equivalence class of \mathcal{C} for \succsim_A .

Definition 13 (Deviation Neighborhood). A deviation neighborhood with respect to A of a relation \mathcal{C} , with respect to a set $A \subseteq \mathcal{N}$, is the set of relations immediately reachable from \mathcal{C} by \succsim_A , in other words:

$$\{\mathcal{C}' \in \mathbb{H}_{\mathcal{N}} \mid \mathcal{C} \succsim_A \mathcal{C}'\}$$

Example 10. For two players 1 and 2, the individual deviation is given in Figure 7. For instance, the deviation neighborhood of \mathcal{C}_1 is $\{\mathcal{C}_1, \mathcal{C}_2, \mathcal{C}_4\}$ with respect to the group $\{1\}$ and $\{\mathcal{C}_1, \mathcal{C}_3, \mathcal{C}_4\}$ with respect to the group $\{2\}$. By deviating from \mathcal{C}_1 to \mathcal{C}_2 (resp. \mathcal{C}_1 to \mathcal{C}_3) player 1 (resp. player 2) remains selfish.

- Individual evolving relation for players 1 and 2 -

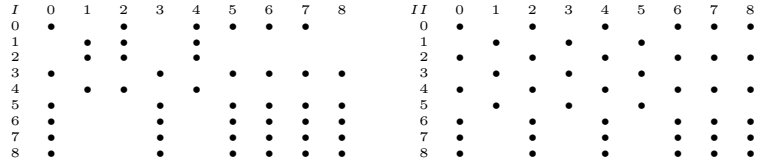

- Transitive reduction -

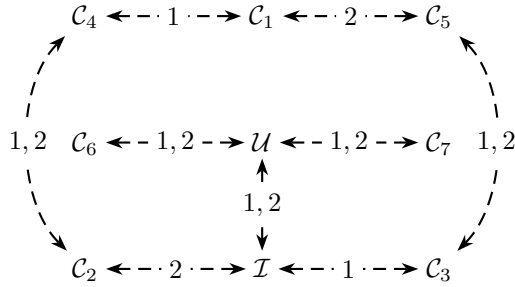

The above diagrams describe the individual deviations for groups made of the first player and the group made of the second player. (Notice that the deviation is symmetric.) The graph draws the transitive reduction of the individual relations. Reflexive edges are omitted.

Figure 7: Individual deviation relation for two players.

Stability says that no cooperation in the neighborhood can be an improvement. A principle of *stability* for hedonic relations can be stated as follows:

Definition 14 (Stability of Hedonic Relation). Let \mathcal{N} be a set of players, let $\mathcal{C} \in \mathbb{H}_{\mathcal{N}}$ be a cooperation, let $\alpha : \mathcal{N} \rightarrow \mathbf{2}^{\mathcal{N}}$ be a function such that $a \in \alpha(a)$, \mathcal{C} is *stable* if and only if:

$$\forall a \in \mathcal{N}, \forall \mathcal{C}' \in \mathbb{H}_{\mathcal{N}}. \mathcal{C} \succ_{\alpha(a)} \mathcal{C}' \wedge \mathcal{C} \xrightarrow{\text{H}}_a \mathcal{C}' \implies \mathcal{C} = \mathcal{C}'$$

where $\xrightarrow{\text{H}}_a$ is a preference relation (see Table 3).

A stable hedonic relation is an abstract Nash equilibrium in a CP game whose situations are cooperations and conversions are deviations.

Definition 15 (Hedonic Relation Games).

Let \mathcal{N} be a set of players, a HedN game is a CP game

$$\langle \mathcal{N}, \mathbb{H}_{\mathcal{N}}, (\succ_{\alpha(a)})_{a \in \mathcal{N}}, (\xrightarrow{\text{H}}_a)_{a \in \mathcal{N}} \rangle$$

A HedN game depends on two parameters α and $(\xrightarrow{\text{H}}_a)_{a \in \mathcal{N}}$. Table 3 gives how those parameters can be instantiated yielding several kinds of HedN games. The concepts of stability afore mentioned in the introduction (namely: Strong, Core, Nash, Individual and Contractual individual) correspond to specific classes of HedN games. Table 3 gives the deviation and the preference for each of these classes. In Core and Strong HedN games α is the constant function $a \mapsto \mathcal{N}$ whereas for other HedN games, based on an individual deviation, α is the singleton function $a \mapsto \{a\}$. The classes of HedN games have stability concepts that fit with those on relations of Bogomolnaia and Jackson (2002); Banerjee et al. (2001). The framework is general enough to foresee other possible combinations¹⁰ which may differ for those described in Table 3. The *improving deviation*, that is the change of mind of the HedN game, will be denoted by $\xrightarrow{\text{H}}$.

Name	$\succ_{\alpha(a)}$	$\xrightarrow{\text{H}}_a$	
Strong	$\succ_{\mathcal{N}}$	$\succ_{\mathcal{N}}$	
Core	$\succ_{\mathcal{N}}$	$\{ \mathcal{C} \succeq_{\Pi_{\mathcal{C}'(a)}} \mathcal{C}' \}$	$\mathcal{C}' \}_{(\mathcal{C}, \mathcal{C}') \in \mathbb{H}_{\mathcal{N}} \times \mathbb{H}_{\mathcal{N}}}$
Nash	\succ_a	\succ_a	
Individual	\succ_a	$\{ \mathcal{C} \succeq_{\Pi_{\mathcal{C}'(a)}} \mathcal{C}' \}$	$\mathcal{C}' \}_{(\mathcal{C}, \mathcal{C}') \in \mathbb{H}_{\mathcal{N}} \times \mathbb{H}_{\mathcal{N}}}$
Contractual individual	\succ_a	$\{ \mathcal{C} \succeq_{\Pi_{\mathcal{C}(a)} \cup \Pi_{\mathcal{C}'(a)}} \mathcal{C}' \}$	$\mathcal{C}' \}_{(\mathcal{C}, \mathcal{C}') \in \mathbb{H}_{\mathcal{N}} \times \mathbb{H}_{\mathcal{N}}}$

Table 3: Deviation Relations and Preferences for Classes of HedN game

¹⁰As a possibility, let us mention the combination $\succ_{a\mathcal{C} \cup \mathcal{C}a}$ and $\succeq_{a\mathcal{C} \cup \mathcal{C}a}$ where \mathcal{C} is the current cooperation (*i.e.*, the cooperation in the left hand side).

Remark 4. An equilibrium found for a specific sort of HedN game can also be considered as an equilibrium for an other sort of Hedn game. Indeed, using the same set of players and so the same set of hedonic relations, it is easy to check that an abstract Nash equilibrium of the Nash HedN game is an abstract Nash equilibrium of the Individual HedN game. In turn, this equilibrium is an abstract Nash equilibrium of the Contractual Individual HedN game. We actually extend to HeDN games a well-known property defined for hedonic games (*cf.* Bogomolnaia and Jackson (2002)). The inclusion property of equilibria of a given type to another can be extended to collective deviation: an abstract Nash equilibrium of a Core HedN game is also a Strong abstract Nash equilibrium. Thus, we have the following implications:

$$\text{AN}_{\text{Nash}}(\mathcal{C}) \implies \text{AN}_{\text{Individual}}(\mathcal{C}) \implies \text{AN}_{\text{Contractual Individual}}(\mathcal{C}) \quad (1)$$

$$\text{AN}_{\text{Core}}(\mathcal{C}) \implies \text{AN}_{\text{Strong}}(\mathcal{C}) \quad (2)$$

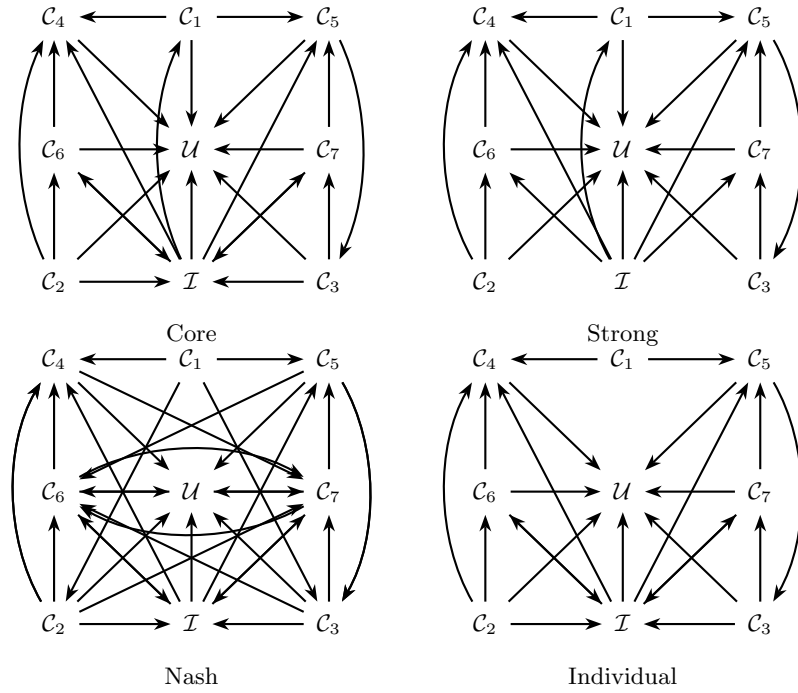

In the graph the reflexive pairs have been intentionally omitted.

Figure 8: Global change of mind for Core, Strong, Nash and Individual HedN games.

4.2. A tour of HedN-games: the prisoner's dilemma

We examine on prisoners' dilemmas basic properties of the Core, Strong, Nash and Individual¹¹ classes. This will essentially clarify aspects of HedN games by deepening specific features of each class and their relations with each other.

Figure 8 shows the changes-of-mind of the HedN games on prisoner's dilemma. In HedN game with collective deviation, that are Core and Strong HedN games, the change-of-mind is the preference since situations, namely hedonic relations, are neighbors, with respect to \mathcal{N} . Indeed, for any cooperation $\mathcal{C}, \mathcal{C}'$, we have: $\mathcal{C} \succ_{\mathcal{N}} \mathcal{C}'$ (because by definition $\mathcal{C} \cap \emptyset \times \emptyset = \mathcal{C}' \cap \emptyset \times \emptyset$). Thus, the intersection of conversions and preferences, namely changes-of-mind, matches preferences. Therefore, the structure of the HedN game is only governed by the structure of the improvement. Although the deviation involves potentially all players, this does not require necessary to update all the elementary relations (namely the pairs) because the modification can be partial (e.g., $\mathcal{C}_4 \succ_{\mathcal{N}} \mathcal{C}_7$). For prisoners' dilemmas, the Core and Strong HedN game improvements refer to a global consent preventing an unidirectional deviation. For instance, player 1 cannot deviate from \mathcal{U} to \mathcal{C}_6 by removing her support to player 2 because players 2 finds this unprofitable. This leads to a single abstract Nash equilibrium \mathcal{U} which in turn induces a CP equilibrium in the context game, thus catching all situations (cf. Table 2). Hence, the actual choices of the players do not converge to a stable equilibrium and stay inside a stable coalition structure yielding an internal conflict.

Nash HedN game characterizes non-cooperative behaviors (cf. Bogomolnaia and Jackson (2002)). Indeed, players behave selfishly while expecting to be supported by others. For prisoners' dilemmas, this fits with the intuition in favor of a reduced cooperation: a single CP equilibrium emerges precluding the altruistic cooperation \mathcal{C}_1 which acts as a repeller.

Individual HedN games produce the same result as Strong or Core HedN games despite due to a more restrictive deviation neighborhood they remove some change-of-mind edges. The symmetrical behavior of players in the context game, namely prisoner's dilemma, induces also a symmetry in the Individual HedN game. Still, \mathcal{U} is an equilibrium and the individual deviation repels the altruistic cooperation \mathcal{C}_1 .

5. Hedonic Relation Stability Condition

Obviously, checking whether a stable hedonic relation exists is equivalent to prove the existence of an abstract Nash equilibrium because a stable hedonic relation is an abstract Nash equilibrium in a HedN game. Conversely, the existence of non-singleton CP equilibria is a consequence of the absence of Nash

¹¹We will consider *Contractual Individual HedN games* as a refinement of *Individual HedN games*.

equilibria in HedN games. In literature, what we call a non-singleton CP equilibrium is a family of cycles in the graph that represents the decision making process. Jackson and Watts (2002) introduce the notion of *closed improving cycles* as the cause of the non-existence of a stable network in network formation games¹². An improving path of networks (here, assimilated to hedonic relations) emerges when individuals update a network because the resulting network improves the current network. An improving cycle implies the presence of an improving path between any network in the cycle. It is closed if no improving path escapes from the cycle. In hedonic games, various examples have a cycle and therefore show that there do not exist stable coalition structures¹³.

Indeed, the concept of non-singleton CP equilibrium generalizes this of closed improving cycle in CP games as sink strongly connected components, which can be seen as a union of collectively closed cycles. Thereby, sufficient conditions of stability can either be deduced from the existence of an abstract Nash equilibrium or from the absence of a non-singleton CP equilibrium.

Stability condition emphasizes properties which explain a social organization. The proposed approach is focused on the analysis of the decision making process where players attempt to make a hedonic relation to evolve for the better. Here, the stability condition sets a relation between cooperation and strategic interactions with the context, namely a context game. Therefore, the approach shifts the standpoint from a comparison of hedonic relations computed independently toward an evolution of the context game due to the alteration of the current hedonic relation. The approach contrasts somewhat with the definitions of the deviation and the improvement, which are both based on a comparison between two independent relations. We expect to capture some principles that govern the decision makers when they assess the possibility of the evolution of supports according to a context of strategic interactions.

5.1. Stability Condition

The transformations of the hedonic relation can be decomposed in two elementary operations: *addition* and *removal* of supports. We examine the transformations of the context game by these elementary operations.

Given an improving deviation between two hedonic relations $\mathcal{C} \xrightarrow{H}_a \mathcal{C}'$, the set of added supports is $\mathcal{C}' \setminus \mathcal{C}$ whereas the set of removed supports is $\mathcal{C} \setminus \mathcal{C}'$. We focus on the transformations of a hedonic relation \mathcal{C} on the quotient transferred context game $[\mathbf{Trans}_{\mathcal{C}}(\Gamma)]$. In fact, the quotient transferred game is determined by the quotient *transferred change of mind*. The transformations of the hedonic relation modify the transferred change of mind. From Definition 8 we get the change of mind of the game $\mathbf{Trans}_{\mathcal{C}}(\Gamma)$:

Transferred changes of mind: Let \mathcal{C} be a hedonic relation, the *changes of*

¹²See Example p. 379 in Jackson (2008)

¹³See the introductory Example - p. 2 and Game 1 - p. 5 in Banerjee et al. (2001) and Example 4, p. 209 in Bogomolnaia and Jackson (2002)

mind after transfer are the changes of mind of the game $\mathbf{Trans}_{\mathcal{C}}(\Gamma)$, namely

$$\rightarrow_a^{\mathcal{C}} = \rightarrow_a \cap \bigcup_{b \in a\mathcal{C}} \dots \rightarrow b, a \in \mathcal{N}.$$

A support added to a hedonic relation may add a pair to the transferred change of mind, whereas a support removal may induce the removal of a pair from the transferred change of mind. Figure 9 gives the transformations from the quotient transferred change of mind. Two cases must be considered: either the transformation involves non terminal strongly connected components or it involves only terminal strongly connected components.

Additions to the quotient transferred change of mind. The addition in the change of mind modifies the structure of the quotient transferred change of mind only if a new link connects two SCC's. Indeed a link added inside a SCC does not modify the quotient change of mind structure. There are two cases: either the link is a merging link (Figure 9 *a,b*) or it is a unidirectional link (Figure 9 *e,f*). Whatever the status of the merged SCC's, this process is always an improvement (Proposition 2). Therefore, the only condition which prevents occasionally an improvement is the unidirectional link between two terminal SCC's. In this case some equilibria can be lost without any compensation; the preserved equilibria are not preferred to the lost ones.

Removals to the quotient transferred change of mind. The removal of supports brings also two structural modifications on the quotient context game: either a split (Figure 9 *c,d*) or an unidirectional link (Figure 9 *e,f*). The former is an improvement because it does not change the status of equilibria. They are only separated. The latter partly splits a SCC into several SCC's while maintaining a link between them. Again, the removed equilibria may not be compensated by the preserved ones.

Context based stability condition. In summary, the alteration of the quotient transferred change of mind combines three fundamental transformations : merging, splitting and unidirectional linking. Among these transformations only the last one may not improve the current equilibria, leading to a stable hedonic relation. This results either in the addition or the removal of supports. Theorem 2 expresses this conclusion. Informally, it states that the stability of a hedonic relation \mathcal{C} implies that any deviation removes at least one equilibrium which cannot be compensated by either a novel or a preserved equilibrium.

- Initial Quotient Transferred change of mind $[\rightarrow^c]_\Gamma$ -

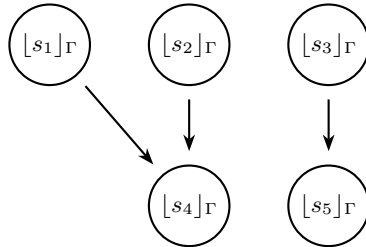

- Transformations on the Quotient Transferred change of mind $[\rightarrow^{c'}]_\Gamma$ -

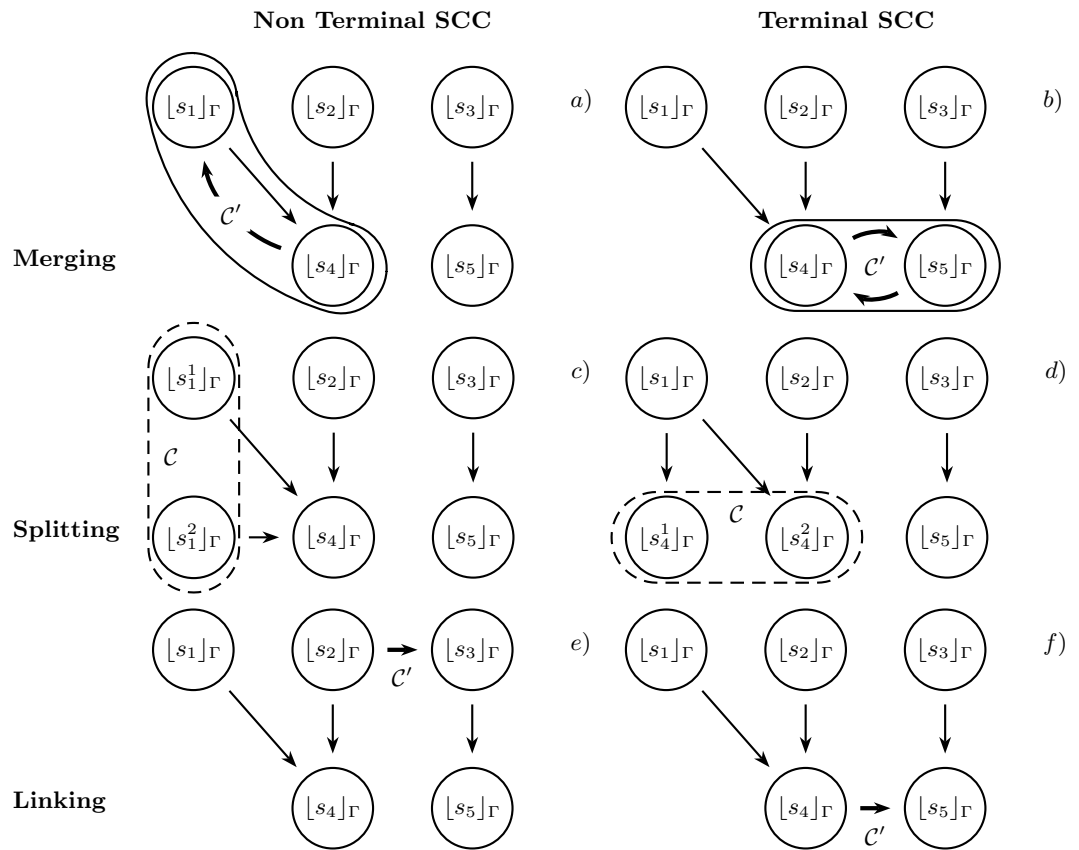

Figure 9: Basic Transferred change of mind Transformation

Theorem 2 (Stability Condition). Let $\Gamma = \langle \mathcal{N}, S, (-\rightarrow_a)_{a \in \mathcal{N}}, (\cdots \rightarrow_a)_{a \in \mathcal{N}} \rangle$ be a context game, let $\langle \mathcal{N}, \mathbb{H}_{\mathcal{N}}, (\succ_{\alpha(a)})_{a \in \mathcal{N}}, (\preceq_{\beta(a)}^{\Gamma})_{a \in \mathcal{N}} \rangle$, be a HedN game where $\beta : \mathcal{N} \rightarrow \mathbb{H}_{\mathcal{N}} \rightarrow \mathbb{H}_{\mathcal{N}} \rightarrow \mathcal{Z}^{\mathcal{N}}$ stands for a function selecting players such that $\mathcal{C} \xrightarrow{H} \cdots \rightarrow_a \mathcal{C}' = \mathcal{C} \preceq_{\beta(a, \mathcal{C}, \mathcal{C}')}^{\Gamma} \mathcal{C}'$; a hedonic relation \mathcal{C} is stable if:

$$\begin{aligned} \forall a \in \mathcal{N}, \forall \mathcal{C}' \in \mathbb{H}_{\mathcal{N}}, \exists [s_{\mathcal{C}}] \subseteq S. \mathcal{C} \succ_{\alpha(a)} \mathcal{C}' \wedge \text{CP}_{\text{Trans}_{\mathcal{C}}(\Gamma)}([s_{\mathcal{C}}]) \implies \\ \forall [s_{\mathcal{C}'}] \subseteq S, \exists a' \in \beta(a, \mathcal{C}, \mathcal{C}'). \text{CP}_{\text{Trans}_{\mathcal{C}'}(\Gamma)}([s_{\mathcal{C}'}]) \implies \\ \neg s_{\mathcal{C}} \cdots \rightarrow_{a'} s_{\mathcal{C}'} \wedge s_{\mathcal{C}} \notin [s_{\mathcal{C}'}]. \end{aligned}$$

5.2. Discussion

In this section we discuss specific features of HedN games compared to other models.

Like Network formation games, HedN games provide a theoretical tool for studying the structure of social patterns framing the cooperation. Here, the network is directed and a link represents a support, not a mutual consent, *i.e.*, it goes in one direction. Instead of defining a utility function that depends on the network structure, we evaluate the hedonic relation by its application to a context game. This scheme offers a complementary insight in the decision-making process of cooperation, it is based on the relationship between the cooperation actions and their concrete expression on a context.

The cooperation viewed as a collection of supports leads apparently to an unusual result for prisoners' dilemmas. Indeed, \mathcal{U} is the only stable relation which can be reached from \mathcal{I} as a result of successive merging steps. Whenever players can increase the set of equilibria they cooperate. If we interpret the increase as an increase of the players possibilities this is common sense. It is however worth noticing that this precludes mutual altruism, namely equilibrium \mathcal{C}_1 ; raising the question: why this preclusion? A way of answering this question is to consider some necessary conditions enforcing \mathcal{C}_1 to become an equilibrium. Two kinds of constraints are then brought to the fore: the necessity of exchange or resource limitation. Even partly, when players cooperate the exchange is embodied by a renouncement to the owned gains. For instance, if we impose that two hedonic relations are compared only if their sets of equilibria are necessarily partly disjoint then it is easy to check that \mathcal{C}_1 is stable for Core and Individual HedN games. Indeed, the hedonic relations in the deviation neighborhood of \mathcal{C}_1 lead to sets of equilibria which include (Q, Q) . \mathcal{U} also remains stable but it cannot be reached from the selfish relation \mathcal{I} , because there is no improving deviation path (*i.e.*, $\xrightarrow{H} *$) under this condition, which seems implicitly accepted in other models of cooperation like in repeated games Axelrod and Dion (1988).

An alternative is to limit the support ability for each player. Assuming that each player can only support one player, the only stable hedonic relation reached from the selfish relation \mathcal{I} , is \mathcal{C}_1 because only $\mathcal{I}, \mathcal{C}_1, \mathcal{C}_2, \mathcal{C}_3$ fulfill this restriction.

Both conditions exemplified by prisoners' dilemmas opens to refinement of the study of support based cooperation.

6. Conclusion

HedN games are a formal algebraic framework for network based games. They are based on two concepts: first a network of supportive relations between players; second a context for supports that realize the desire of players. Both concepts are based on a common formalism, namely CP games.

HedN games aim at providing a framework to study the structural social pattern formation. Stability condition analyses characteristic modifications and support alterations. In particular, it exhibits relations between cooperative schemes and their consequences to the context of cooperation. The perspectives of this work is for one hand to refine equilibrium concepts and for the other hand to determine the structural properties of stable hedonic relation according to a classification of context games.

References

- Axelrod, R., Dion, D., December 1988. The further evolution of cooperation. *Science* 242 (4884), 1385–1390.
- Ballester, C., Oct. 2004. NP-completeness in hedonic games. *Games and Economic Behavior* 49 (1), 1–30.
- Banerjee, S., Konishi, H., Snmez, T., Jan. 2001. Core in a simple coalition formation game. *Social Choice and Welfare* 18 (1), 135–153.
- Bloch, F., Jackson, M. O., Mar. 2007. The formation of networks with transfers among players. *Journal of Economic Theory* 133 (1), 83–110.
- Bogomolnaia, A., Jackson, M. O., Feb. 2002. The stability of hedonic coalition structures. *Games and Economic Behavior* 38 (2), 201–230.
- Chettaoui, C., Delaplace, F., Lescanne, P., Vestergaard, M., Vestergaard, R., 2006. Rewriting game theory as a foundation for state-based models of gene regulation. In: *Computational Methods in Systems Biology*. Vol. 4210 of *Lecture Notes in Computer Science*. Springer Verlag, pp. 257–270.
- Dreze, J. H., Greenberg, J., May 1980. Hedonic coalitions: Optimality and stability. *Econometrica* 48 (4), 987–1003.
- Garey, M. R., Johnson, D. S., 1990. *Computers and Intractability; A Guide to the Theory of NP-Completeness*. W. H. Freeman & Co., New York, NY, USA.
- Jackson, M. O., 2005. In *Group Formation in Economics: Networks, Clubs and Coalitions*. Cambridge University Press, Ch. A survey of models of network formation: stability and efficiency.
- Jackson, M. O., 2008. *Social and Economic Networks*. Princeton University Press.
- Jackson, M. O., van den Nouweland, A., May 2005. Strongly stable networks. *Games and Economic Behavior* 51 (2), 420–444.
- Jackson, M. O., Watts, A., Oct. 2002. The evolution of social and economic networks. *Journal of Economic Theory* 106 (2), 265–295.
- Jackson, M. O., Wolinsky, A., Oct. 1996. A strategic model of social and economic networks. *Journal of Economic Theory* 71 (1), 44–74.
- Le Roux, S., Lescanne, P., Vestergaard, R., May 2006. A discrete Nash theorem with quadratic complexity and dynamic equilibria. Research Report IS-RR-2006-006, JAIST.
- Lescanne, P., Dec. 2006. CP games: a tutorial. Tech. Rep. RR2006-51, LIP-Ecole normale supérieure de Lyon.
URL <http://prunel.ccsd.cnrs.fr/ensl-00121361>

- Myerson, R. B., 1991. *Game Theory : Analysis of Conflict*. Harvard University Press.
- Rubinstein, A., Julio-Dic 2006. *Lecture Notes in Microeconomic Theory*. No. gradmicro1 in *Online economics textbooks*. SUNY-Oswego, Department of Economics.
URL <http://ideas.repec.org/b/oet/tbooks/gradmicro1.html>
- Senachak, J., Vestergaard, M., Vestergaard, R., 2007. Cascaded games. In: Anai, H., Horimoto, K., Kutsia, T. (Eds.), *AB*. Vol. 4545 of *Lecture Notes in Computer Science*. Springer, pp. 185–201.
- Sung, S., Dimitrov, D., February 2007. On myopic stability concepts for hedonic games. *Theory and Decision* 62 (1), 31–45.
- Tarjan, R. E., Januar 1972. Depth first search and linear graph algorithms. *SIAM Journal on computing*, 146–160.
- van den Nouweland, A., 2005. In *Group Formation in Economics: Networks, Clubs and Coalitions*. Cambridge University Press, Ch. Models of network formation in cooperative games, pp. 58–88.
- Von Neumann, J., Morgenstern, O., March 2007. *Theory of Games and Economic Behavior* (Commemorative Edition), 60th Edition. Princeton University Press.

Appendix

Relational Operations

Let R be a relation defined on a set S (i.e., $R \subseteq S \times S$), the operations are defined in Table 6.

Notation	Description	Definition
R^\smile	the converse	$R^\smile = \{(b, a) \mid (a, b) \in R\}$
aR	the image of a	$aR = \{b \mid (a, b) \in R\}$
Ra	the preimage of a	$Ra = aR^\smile = \{a \mid (a, b) \in R\}$
$R_1 \circ R_2$	the composition	$R_1 \circ R_2 = \{(a, b) \mid aR_1 \cap R_2b \neq \emptyset\}$
R^*	the reflexive transitive closure	$R^* = \bigcup_{i \geq 0} R^i$
\tilde{R}	the symmetric closure	$\tilde{R} = R \cup R^\smile$
$R _A$	the restriction to a set A	$R _A = R \cap (A \times A)$

Table 4: Relational Operations

2^R stands for the set of sub-relations of R , that is $\{R' \mid R' \subseteq R\}$.

Proof of the NP-Completeness of QGC problem (Theorem 1)

NOTATION: Let $G = \langle V, G \rangle$ be a directed graph, we denote by:

- $\delta^+(a)$, the set of output neighbors of a , $\delta^+(a) = \{x \mid (a, x) \in E\}$
- $\delta^-(a)$, the set of input neighbors of a , $\delta^-(a) = \{x \mid (x, a) \in E\}$

The proof proceeds by the reduction of the Hamiltonian path for a graph G . Without loss of generality, we assume that G has no self loop¹⁴ (or reflexive loop).

Hamiltonian path.(HP). Garey and Johnson (1990)

INSTANCE: A directed graph $G = \langle V, E \rangle$ where V is a set of vertices and $E \subseteq V \times V$ a set of edges.

QUESTION: Does it exist a path that visits each vertex exactly once?

Guideline of the proof.

Informally, the vertices of V will be considered as players of game Γ resulting of the transformation. The proof is based on the following arguments: since \mathcal{I} is not effective for players of V , finding an effective cooperation leads to find supporters for each player. If a cooperation \mathcal{C} improving \mathcal{I} exists then the structure of game Γ enforces each player of V to cooperate with at most one of its input or output neighbor. Moreover, as the cooperation must form the grand coalition, it implicitly enforces that any player either cooperates with

¹⁴Self loops never belong to the path by definition of an Hamiltonian path. Hence they can be first removed.

or has for supporter another one player of V at least. Thus, the cooperation forms a path that connects all player of V . At least, the transform also imposes that the cooperation is included to the edges, E . Hence, the Hamiltonian path P is obtained by intersecting the cooperation with E ; (*i.e.*, $P = \mathcal{C} \cap E$). In the following, we consider that a path means a path visiting exactly once each vertex.

QGC Design is in NP.

Given a cooperation \mathcal{C} , checking whether \mathcal{C} improves \mathcal{I} can be performed in polynomial time by computing the transitive closure of preferences for each agent and by insuring that each equilibria of game Γ are connected to at least one equilibrium of $\mathbf{Trans}_{\mathcal{C}}(\Gamma)$ for each player. The complexity is in $\mathcal{O}(|S|^3)$. Determining whether the grand coalition is induced by the cooperation is also in polynomial time ($\mathcal{O}(|\mathcal{N}|^2)$). Hence, QGC is in NP since it exists a polynomial time algorithm to check whether a cooperation improves \mathcal{I} while forming the grand coalition.

Transform of HP to QGC

From a directed graph $G = \langle V, E \rangle$, we define a game $\Gamma = \langle \mathcal{N}, S, \{ \dashrightarrow_a \}_{a \in \mathcal{N}}, \{ \dashleftarrow_a \}_{a \in \mathcal{N}} \rangle$, such that:

players of Γ are vertices of G augmented by one additional player ω : $\mathcal{N} = V \cup \{\omega\}$;

situations corresponds to $S = E \times \{n, e\} \cup \{s_{\text{OUT}}, s_{\text{IN}}\}$. We denote a situation of $E \times \{e, n\}$ respectively by $s_{a,b}^e, s_{a,b}^n$ where (a, b) is an edge of E .

conversions are defined as follows:

- for each edge (a, b) , we define a conversion of player a from situation $s_{a,b}^e$ to situation $s_{a,b}^n$;

$$\forall (a, b) \in E. s_{a,b}^e \dashrightarrow_a s_{a,b}^n; \quad (3)$$

- for each edge (a, b) , we define a conversion of player ω from $s_{a,b}^n$ to situation $s_{a,b}^e$,
- for each edge (a, b) , we define a conversion of player a from $s_{a,b}^n$ to situation s_{OUT} , formally:

$$\forall (a, b) \in E. s_{a,b}^n \dashrightarrow_{\omega} s_{a,b}^e \wedge s_{a,b}^n \dashrightarrow_a s_{\text{OUT}}; \quad (4)$$

- for each edge (a, d) , we define a conversion of player a from situation $s_{x,d}^n$ to situation s_{IN} except if $x = a$, formally:

$$\forall (a, d) \in E, \forall x \in \delta^-(d) \setminus a. s_{x,d}^n \dashrightarrow_a s_{\text{IN}}; \quad (5)$$

- each time it exists a preference ω , a conversion of an unique player of V is added, formally:

$$\forall s \in S, \forall s' \in S, \exists! x \in V. s \xrightarrow{\omega} s' \implies s \xrightarrow{x} s' \quad (6)$$

- also define a conversion of ω from s_{IN} to s_{OUT} : $s_{\text{IN}} \xrightarrow{\omega} s_{\text{OUT}}$;

preferences are defined quite similarly to conversions as follows:

- for each edge (a, b) , we define a preference of player b from situation $s_{a,b}^e$ to situation $s_{a,b}^n$, formally

$$\forall (a, b) \in E. s_{a,b}^e \xrightarrow{b} s_{a,b}^n; \quad (7)$$

- for each edge (a, b) , we define a preferences of players c which are output neighbors of a except b from $s_{a,b}^n$ to situation s_{OUT} , formally:

$$\forall (a, b) \in E, \forall c \in \delta^+(a) \setminus b. s_{a,b}^n \xrightarrow{c} s_{\text{OUT}}; \quad (8)$$

- for each vertex d such that $|\delta^-(d)| > 1$, we define a preference from $s_{x,d}^n$ to s_{IN} , formally:

$$\forall d \in V, \forall x \in \delta^-(d). |\delta^-(d)| > 1 \implies s_{x,d}^n \xrightarrow{d} s_{\text{IN}}; \quad (9)$$

- a preference of ω between s_{IN} and s_{OUT} is added: $s_{\text{IN}} \xrightarrow{\omega} s_{\text{OUT}}$

According to this transform, the equilibria of the cooperative game includes those of the initial game (Proposition 4). Thus, the cooperation preserves equilibria. Therefore, by Proposition 2, the cooperation improves \mathcal{I} .

Proposition 3. *For any cooperation \mathcal{C} , s_{OUT} is an abstract Nash equilibrium.*

PROOF. *No preference and no conversion has s_{OUT} as a source.*

Proposition 4. *If an effective cooperation \mathcal{C} improves \mathcal{I} while forming the grand coalition then \mathcal{C} preserves equilibria.*

- *First, from rule of the transform, the situations being in equilibria for the initial game Γ belong to the following set:*

$$\mathcal{E} = \{s_{a,b}^e | (a, b) \in E\} \cup \{s_{\text{OUT}}\}$$

Indeed, the only change of mind under the assumption that G has no self loop are only generated by conversions and preferences of ω . They all converge to situations of \mathcal{E} .

- *An effective relation forming the grand coalition implies that the player whose conversions match with preferences of ω (Rule 6) , x , cooperates with ω , since it is the only player whose conversion matches with preferences of ω . If it not the case, player ω is isolated.*

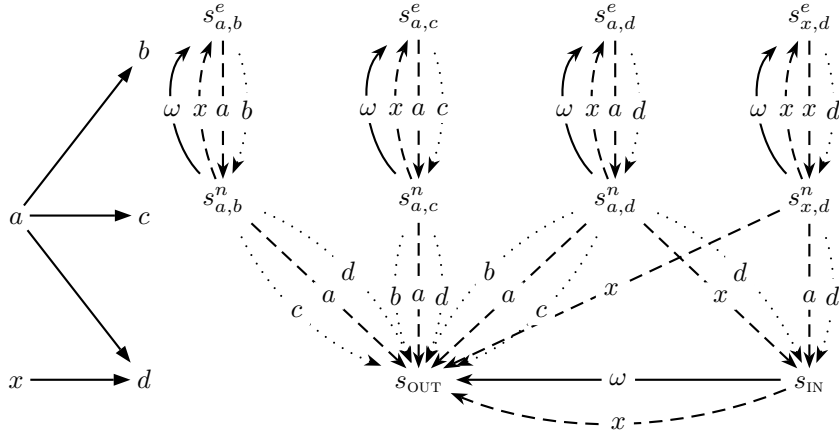

The figure represents the basic steps of the transform according to the left hand side graph by the right hand side game. For the clarity of the representation, preferences and conversion of ω having the same antecedent and image (i.e., source and sink of edges) are represented by a change of mind.

Figure 10: Basic Steps of the Transform

- Hence, it exists a change of mind $s_{a,b}^n \rightarrow_x s_{a,b}^e$ for any edge (a,b) of E .
- As s_{OUT} is an abstract Nash equilibrium (Proposition 3), s_{IN} is not an equilibrium since we have $s_{IN} \rightarrow_x s_{OUT}$
- For all pairs of players (a,b) if a does not cooperate with b then $s_{a,b}^e$ is an equilibrium.
- If a cooperates with b then we have: $s_{a,b}^e \rightarrow_a s_{a,b}^n$.
 - if $s_{a,b}^n$ is an equilibrium, then also $s_{a,b}^e$, since $s_{a,b}^n \rightarrow_x s_{a,b}^e$.
 - if $s_{a,b}^n$ is not an equilibrium then we have $s_{a,b}^n \rightarrow^* s_{OUT}$, hence $s_{a,b}^e \rightarrow^* s_{OUT}$. However, by rules defining preferences, we have:

$$s_{a,b}^e \cdots \rightarrow_b s_{a,b}^n \cdots \rightarrow_c s_{OUT} \implies b \neq c \vee s_{a,b}^e \cdots \rightarrow_b^* s_{IN} \cdots \rightarrow_\omega s_{OUT}.$$

Thus s_{OUT} is not preferred to $s_{a,b}^e$ which contradicts the hypothesis.

Any situation $s_{a,b}^e$ is an equilibrium of the cooperative game, s_{OUT} is an equilibrium whatever the cooperation. Thus \mathcal{E} is included to the set of equilibria of the cooperative game $\mathbf{Trans}_{\mathcal{C}}(\Gamma)$. Hence, \mathcal{C} preserves equilibria.

Since the relation necessarily preserves equilibria, hence improving \mathcal{I} , we now put the focus on conditions to form the grand coalition (Proposition 5).

Proposition 5. Let \mathcal{C} be a relation preserving equilibria, we have

$$\Pi_{\mathcal{C}} = \{\mathcal{N}\} \implies \forall b \in V, \exists a \in V. a \mathcal{C} b \vee b \mathcal{C} a$$

PROOF. by definition of the coalition (Definition 6) players must indirectly cooperate with another one. Assume that it exists a player x of V such that:

$$\forall a \in V. x \mathcal{L}a \wedge a \mathcal{L}x$$

it can only cooperate with the player ω to form the grand coalition, that in turns cooperate with a player of V (or has for other supporter). However, except one specific player x , any other cooperation with ω and a player of V leads to a false relation.

The following proposition provides the detail of the structure of the expected cooperation.

Proposition 6. *An effective relation preserving equilibria \mathcal{C} forms the grand coalition if and only if it is a relation forming a path between players of V and it exists a player x of V such that x cooperates with ω .*

\implies part:

1. each player of V at most cooperates with one another player of V :

$$\text{Preserv}_\Gamma(\mathcal{C}) \implies \forall a \in V, \forall b \in V, \forall c \in V. a\mathcal{C}b \implies a \mathcal{L}c$$

Assume that \mathcal{C} improves \mathcal{I} and it exists a, b, c such that $a\mathcal{C}b \wedge a\mathcal{C}c$. From rules 3, 4 for conversions and rules 7, 8 for preferences we have:

$$s_{a,b}^e \rightarrow_a s_{a,b}^n \rightarrow_a s_{\text{OUT}}$$

Since s_{OUT} is an abstract Nash equilibrium whatever the cooperation (Proposition 3), $s_{a,b}^e$ cannot be not an equilibrium which is false since \mathcal{C} preserves equilibria by hypothesis.

2. Each player has at most one player of V as a supporter:

$$\text{Preserv}_\Gamma(\mathcal{C}) \implies \forall x \in V, \forall a \in V, \forall d \in V. a\mathcal{C}d \implies x \mathcal{L}d$$

Assume that \mathcal{C} preserves equilibria and it exists x, a, d such that $a\mathcal{C}x \wedge d\mathcal{C}x$. From rule 5 for conversions and 9 we have

$$s_{a,d}^e \rightarrow_a s_{a,d}^n \rightarrow_a s_{\text{IN}} \rightarrow_x s_{\text{OUT}}$$

Since s_{OUT} is an abstract Nash equilibrium whatever the cooperation (Proposition 3), $s_{a,d}^e$ cannot be an equilibrium which is false since \mathcal{C} preserves equilibria by hypothesis.

3. to form the grand coalition, the player x of V fulfilling Rule 6 cooperates with ω .

From the previous statements, it exists at most one supporter for any player and at most one input player. Moreover by hypothesis all player must have at least one player either as a supporter or to cooperate with (Proposition 5), we deduce that the cooperation forms a path between all players of V and a player x cooperates with ω .

\longleftarrow part:

1. Assume that the effective relation forms a path and x cooperates with ω , by definition of the coalitions (Definition 6), the relation forms the grand coalition.
2. As the relation forms a path between pairs of V , we cannot have: $s_{a,b}^e \rightarrow^* s_{\text{OUT}}$. Hence, we have:

$$\forall s \in S. s_{a,b}^e \rightarrow s \implies s \rightarrow s_{a,b}^e$$

since the only situation reached by a change of mind from $s_{a,b}^e$ is $s_{a,b}^n$ which in turns reaches $s_{a,b}^e$ ($s_{a,b}^n \rightarrow_x s_{a,b}^e$) since x cooperates with ω . As s_{OUT} is an equilibrium for any relation, we conclude that the equilibria of the initial game belong to the set of equilibria of the cooperative game. Thus, the cooperation preserves equilibria.

A relation having a path between players of V and x cooperates with ω implies that it forms the grand coalition and belong preserves equilibria.

As the previous proposition proves the existence of a path between all players it can be used to define the Hamiltonian path unlike this path does not belong to the set of edges. The following proposition demonstrates that this path is indeed included to the set of edges.

Proposition 7. *Let \mathcal{C} be an effective relation we have:*

$$\forall a \in V, \forall b \in V. (a, b) \in \mathcal{C} \implies (a, b) \in E$$

- By definition of the transform any edge (a, b) is transformed into a conversion for a and a preference for b between the same situation. Thus we have:

$$\forall (a, b) \in E \Leftrightarrow \exists s \in S, \exists s' \in S. s \dashrightarrow_a s' \wedge s \cdots \rightarrow_b s'$$

the following pairs: $(s_{a,b}^e, s_{a,b}^n), (s_{a,b}^n, s_{\text{OUT}}), (s_{x,b}^n, s_{\text{IN}})$ with $x \neq a$ instantiate (s, s') .

- Assume that it exists a pair $(a, b) \in \mathcal{C}$ such that a and b belong to V which is not an edge of E . According to the previous statement, the conversions of a and the preferences of b are never connected to the same situations. Thus, the relation is false that contradicts the assumption concerning the relation.

Lemma 1 ($QGC \Leftrightarrow HP$).

PROOF.

$$QGC \implies HP.$$

Let \mathcal{C} be an effective improving relation while forming the grand coalition for a game Γ . By Proposition 4, \mathcal{C} preserves equilibria. A relation that preserves equilibria while forming the grand coalition implies that it exists a path between all players of V (Proposition 6) that is included in E (Proposition 7). The Hamiltonian path P of graph G is given by:

$$P = E \cap \mathcal{C}$$

$QGC \Leftarrow HP$.

Conversely, assume that it exists an Hamiltonian path P of graph G . let

$$\mathcal{C} = P \cup \{(x, \omega)\}$$

where x is the player of V fulfilling Rule 6, be a cooperation applied on game Γ .

- As P is an Hamiltonian path between all players of V and x cooperates with ω , thus \mathcal{C} forms the grand coalition.
- The relation corresponds to an effective relation since the existence of an edge $(a, b) \in E$ implies $s_{a,b}^e \dashrightarrow_a s_{a,b}^n \wedge s_{a,b}^e \dashrightarrow_b s_{a,b}^n$ (Proposition 7, first item).
- From Proposition 6, an effective relation having a path between players of V and x cooperating with ω implies that this relation preserves equilibria. Thus it improves \mathcal{I} (Proposition 2), and forms the grand coalition.

Proof of Theorem 1. Since QGC is in NP and HP is reduced to QGC (Lemma 1) we conclude that QGC is NP complete.

Proof of Proposition 2.

Without loss of generality, we consider that $\mathcal{C} = \mathcal{I}$. By definition of the transitive closure and the preservation property, we have:

$$\forall a \in \mathcal{N}, \forall s \in S. CP_{\Gamma}(s) \implies s \dashrightarrow_a^* s \wedge CP_{\text{Trans}_{\mathcal{C}}(\Gamma)}(s)$$

Thus, \mathcal{I} is improved by \mathcal{C} by definition.

Proof of Theorem 2

Let us remark first that the stability condition is obviously achieved if no deviation is possible. Therefore, proof of Theorem 2 will be done by considering that a deviation exists, that is $\mathcal{C} \succ_{\alpha(a)} \mathcal{C}'$. Two cases are considered:

First, Assume that for all players $a' \in \beta(a, \mathcal{C}, \mathcal{C}')$, it exists an equilibrium, $[s_{\mathcal{C}'}]$, such that $s_{\mathcal{C}} \dashrightarrow_{a'} s_{\mathcal{C}'}$. Then \mathcal{C}' is preferred to hedonic relation \mathcal{C} by Definition 14 and Definition 10. Therefore \mathcal{C} is not stable. The other case concerns the situation where $s_{\mathcal{C}} \in [s'_{\mathcal{C}}]$. In this case $[s_{\mathcal{C}}] = [s'_{\mathcal{C}}]$ by definition of quotient class. Hence, $s_{\mathcal{C}}$ belongs to a CP equilibrium. Thus, \mathcal{C}' is preferred to hedonic relation \mathcal{C} by Proposition 2. Therefore \mathcal{C} is not stable. In both cases, the stability hypothesis is contradicted.