



HAL
open science

A proposal to compare electro-pneumatic continuous control valves : required main characteristics

Sylvie Sesmat, Rosario de Giorgi, Eric Bideaux, Daniel Thomasset, Daniel Hubert, Jean Paul Lecerf

► **To cite this version:**

Sylvie Sesmat, Rosario de Giorgi, Eric Bideaux, Daniel Thomasset, Daniel Hubert, et al.. A proposal to compare electro-pneumatic continuous control valves : required main characteristics. FPMC (Symposium on Power Transmission and Motion Control), Sep 2007, Bath, United Kingdom. hal-00380648

HAL Id: hal-00380648

<https://hal.science/hal-00380648>

Submitted on 18 Mar 2019

HAL is a multi-disciplinary open access archive for the deposit and dissemination of scientific research documents, whether they are published or not. The documents may come from teaching and research institutions in France or abroad, or from public or private research centers.

L'archive ouverte pluridisciplinaire **HAL**, est destinée au dépôt et à la diffusion de documents scientifiques de niveau recherche, publiés ou non, émanant des établissements d'enseignement et de recherche français ou étrangers, des laboratoires publics ou privés.

A proposal to compare electro-pneumatic continuous control valves: required main characteristics

S. Sesmat*, R. de Giorgi*, E. Bideaux*, D. Thomasset*, D. Hubert, J.P. Lecerf*****

* Ampere, INSA-Lyon, F-69621, France

** ASCO-Joucomatic, France

*** CETIM, France

ABSTRACT

Comparative characteristics of components are required to make the adequate choice according to the desired performances or requirements of the system to be designed. This paper proposes to define a set of characteristics, which constitute the needed data for comparing the performances of electro-pneumatic continuous control valves including pressure or flow control valves. These static and dynamic characteristics correspond to the essential information required by users to make a proper choice at the design stage. The associated experimental test rig and procedures for determining these characteristics are also shortly described.

1. INTRODUCTION

When designing or implementing a pneumatic system or a pneumatic circuit, comparative characteristics are required to make the adequate choice of components according to the desired performances or design requirements. Whereas functionalities and reliability of the designed system are more affected by the chosen architecture, the physical performances of pneumatic circuits are mainly related to the components characteristics.

Up-to-now, much attention has been paid to the determination of mass flow rate characteristics of components that are considered as fixed orifices [1]. Several works deal with the mass flow rate characteristics of more complex components [2] such as silencers, valve manifolds, or combined systems with an inlet and an exhaust ports such as solenoid valves but in this last case, the mass flow rate is given according to the maximum valve opening [3].

An electro-pneumatic continuous control valve is a control valve which continuously modulates the transmitted pneumatic power in response to an electrical continuous input signal. These components must be classified into two types according to their function since the electrical control signal can be related to a pressure value (pressure control valves)

or to an effective variable section of each port of the flow rate stage (flow rate control valves). These control valves include electrically modulated pneumatic proportional valves, proportional control valves and servo valves. In this paper only devices with exhaust port to atmosphere are considered.

Pressure regulators and servo valves, which are electro-pneumatic continuous control valves, are complex components since their internal circuit is composed of several restrictions with variable flow areas. For these components, the static mass flow rate characteristics must be completed by other static characteristics and by dynamic characteristics to make the comparison between components possible.

Several works have been done on the modelling of these types of components in order to define simulation models, and some others have been conducted on the determination of different characteristics, for example static characteristics obtained by tests in stationary or in transient conditions [4, 5], or also, dynamic characteristics of valves [6]. But, none presents a global testing and characterizing procedure that could be used as a basis for comparing such components. Therefore, the purpose of this paper proposes to define a set of characteristics, which constitute the needed data for comparing the performances of electro-pneumatic continuous control valves and the associated experimental procedures for determining these characteristics. For each type of control valve, this paper will justify the essential information required for an objective comparison before developing on one side, the static characteristics and on the other side, the dynamic characteristics.

2. ELECTRO-PNEUMATIC PRESSURE CONTINUOUS CONTROL VALVES

The electro-pneumatic pressure continuous control valves are generally used to provide rapidly a flow in open or closed pneumatic circuits in order to reach a desired operating pressure, and then to keep this pressure in despite of perturbations in the working conditions. The choice of such a component is consequently guided by performances related to static and dynamic characteristics. Several aspects are required for an adequate choice:

- the performances of the pressure regulation in stationary conditions: precision according to perturbations in working conditions, saturation, sensitivity, and dead zone,
- the dynamic performances according to changes in the control value: response time, time delay, overshoot, bandwidth.

Due to the complexity of these components and the different existing technologies, the use of a single and general model is not conceivable. The performances must be deduced from a set of characteristics, which can be obtained for any components in the most objective manner. Therefore, our proposal consists in defining a minimal set of data or characteristics evaluating the quality of the relation between the electrical signal (input) and the operating pressure (output), which are sufficient to make a proper choice:

- the control-pressure characteristics at null operating flow rate give the precision and the regularity of the pressure regulation for a closed circuit.
- the flow-pressure characteristics correspond to the admissible working domain of the component at a given inlet pressure. This information is useful for open circuits. It can be also interpreted as the component performance in pressure regulation according to the operating flow.
- the pressure regulation characteristics show complementary information about the component performance in pressure regulation according to the inlet pressure. This is of interest to select the right inlet pressure or the sizing of the upstream circuit.
- Finally, the dynamic characteristics give some indication on the component response to changes in the control value for different magnitudes. These data, limited here to closed circuit, are naturally not sufficient to fully characterize the dynamic of the component, but it seems sufficient for most of the applications. Due to the highly non linear behaviour of these components and the asymmetry of their architecture, a full characterisation would have required too many measurements.

For all the tests, the pressure measurements have to be done using external sensors even if the device has an internal pressure sensor. The use of an external sensor leads to a more objective comparison of components as the evaluation does not depend on the internal pressure sensor characteristic.

2.1 Static characteristics

2.1.1 Control-pressure characteristics at null operating flow rate

The control-pressure characteristics are deduced from the hysteresis curve describing the measured operating pressure versus the electrical control signal varying in both directions on its full scale, while the operating flow rate is null, for a constant inlet pressure as shown schematically in Figure 1b.

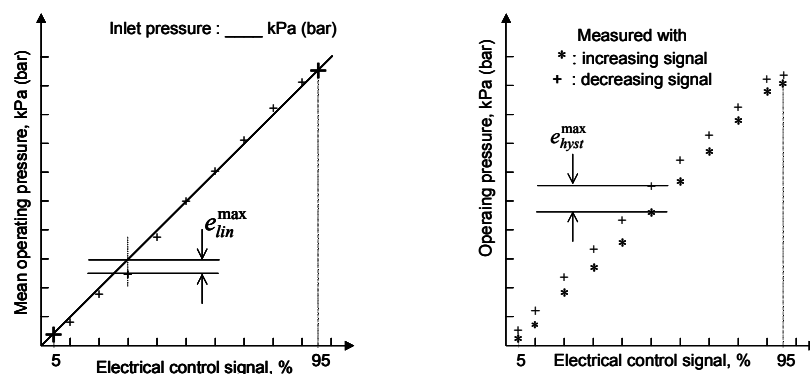

a) Maximal linearity difference

b) Maximal hysteresis difference

Figure 1 Control-pressure characteristic curve at null operating flow rate and determination of characteristic parameters

This characteristic curve is obtained using the test rig shown on Figure 2. The inlet and operating pressure sensors are external sensors plugged on measurement tubes according to the ISO 6358 standard [1].

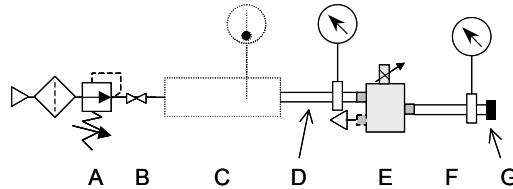

A	Supply pressure regulator	E	Device to be characterized
B	Shut-off valve	F	Downstream measurement tube
C	Temperature measurement tube	G	Plug
D	Upstream measurement tube		

Figure 2 Test rig for control-pressure characterisation

To build an objective comparison of components based on the obtained characteristic curve, three complementary characteristic values have to be determined: the linearity, the control-pressure hysteresis and the threshold. These values quantify the precision, the regularity and the sensitivity of the pressure control valve for a closed circuit. Figure 1 shows respectively the determination of graphical data necessary to calculate the linearity (Eq. 1) and the hysteresis (Eq. 2). The linearity is obtained by comparing the measured pressures to the component gain defined as the straight line between the operating pressure values obtained for 5% and 95% of the control signal full scale.

$$lin = \frac{|e_{lin}^{max}|}{\max(p_{oper})} \times 100 \quad (1)$$

$$hyst = \frac{|e_{hyst}^{max}|}{\max(p_{oper})} \times 100 \quad (2)$$

The threshold is corresponding to the sensibility near the null control signal. It is defined for the null operating flow and corresponds, on the control-pressure curve, to the minimal value of the control signal at which the operating pressure starts to change from the value reached at the null control signal. It can be determined in two ways:

- either by the smallest control signal value at which the mean of the measured operating pressures starts to change from the value reached at the minimal control signal (case a),
- or by the control signal value at which the characteristic curve intersects the abscissa axis (case b).

The threshold value, defined as a percentage of the control signal full scale, is then chosen as the maximal value of these two previous values as shown in Figure 3.

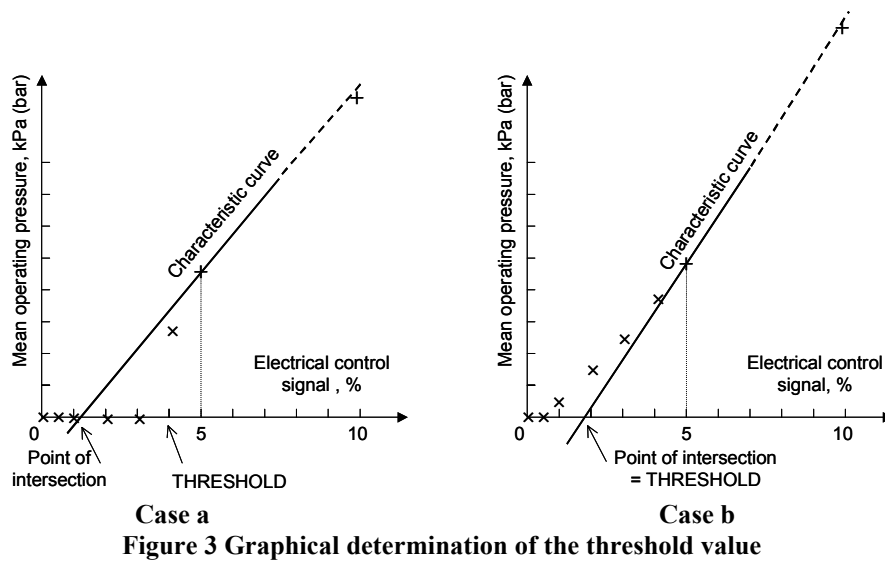

2.1.2 Flow-pressure characteristics

The flow-pressure characteristic curve shows the evolution of the operating pressure according to the operating flow rate that can be considered as a perturbation while the control signal and the inlet pressure are kept constant. Due to the non linear behaviour of the component it is interesting to plot this curve for at least four different settings of the electrical control signal: 25%, 40%, 63% and 80% of the control signal full scale as shown in Figure 4. These curves indicate the pressure static error for a given control signal value according to the flow rate passing through the component.

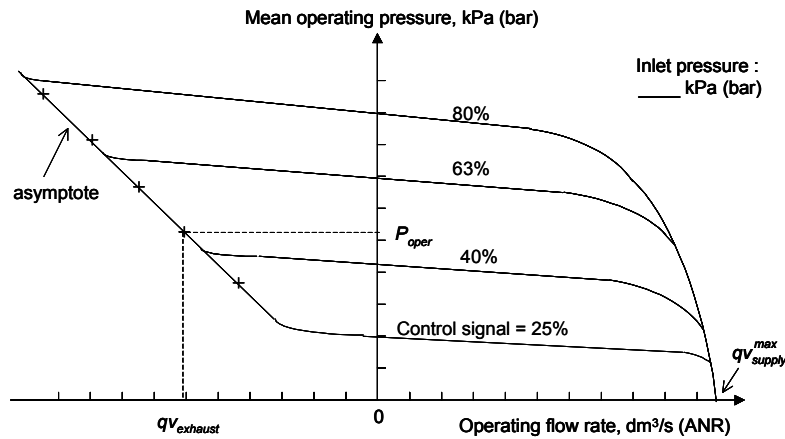

Due to the application ranges, the electro-pneumatic pressure continuous control valves have to be characterized for supply flow rates as well as for exhaust flow rates, for both increasing and decreasing flow values. It requires two test rigs using a mass flow meter,

modified from the ones of the ISO 6358 standard as shown in Figure 5. In both cases, the component inlet port has always to be connected to the supply circuit with the inlet pressure kept constant, and the exhaust port must always be connected to the atmosphere. These requirements are important since the component has to be characterized according to its normal use. Therefore the flow-meter has to be located at the operating port, in order to measure the useful operating flow rate.

Since the aim of this type of characterisation is the evaluation of the quality of the pressure regulation according to the operating flow rate, it is essential that the pressure regulation is well established. Stationary measurements are thus the most convenient even if some works [5, 7] have shown that alternative methods for measuring the supply flow rate using the charge of an isothermal tank can be used. It can be noticed that using this type of characterisations, it is not possible to measure the flow-pressure hysteresis.

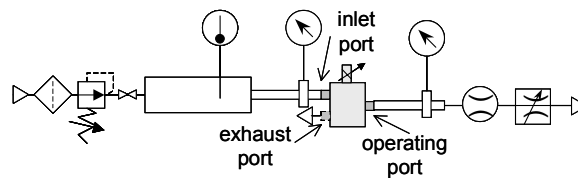

a) Supply flow rate-pressure characterization and pressure regulation test circuit

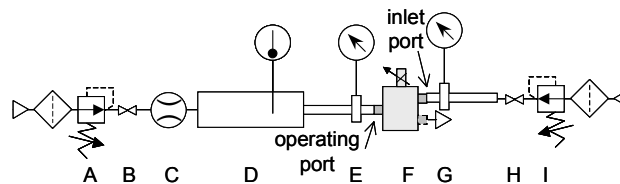

b) Exhaust flow rate-pressure characterisation

A	Operating pressure regulator (upstream)	E	Upstream measurement tube (operating)
B	Upstream shut-off valve	F	Device to be characterized
C	Operating flow-meter	G	Inlet measurement tube
D	Upstream temperature measurement tube (operating)	H	Supply shut-off valve
		I	Supply pressure regulator

Figure 5 Test circuits for flow-pressure characterisation

Three quantitative parameters can be determined from this characterization: the flow-pressure hysteresis determined in a similar manner as in Figure 1b using equation (2), and the supply and the exhaust maximum sonic conductances.

The maximal sonic conductances values, corresponding to the maximal supply or exhaust areas of the control valve, are obtained from equations (3) and (4). These values enable a quick comparison of the maximal flows and consequently the range of the admissible working domain of the pressure control valves. The flow rates values, which are needed for the computation of these parameters, can be identified from the flow-pressure

characterisation as shown in Figure 4. The maximal sonic conductance in the exhaust conditions is then determined by the average value of 5 sonic conductances obtained from Eq. (4) using 5 points all over the asymptote of the exhaust flow rate-pressure curves (Figure 4).

$$C_{supply}^{max} = \frac{q_{supply}^{max}}{P_{inlet}} \sqrt{\frac{T_{inlet}}{T_0}} \quad (3)$$

$$C_{exhaust} = \frac{q_{exhaust}}{P_{oper}} \sqrt{\frac{T_{oper}}{T_0}} \quad (4)$$

2.1.3 Pressure regulation characteristic

The effects of the inlet pressure on the operating pressure can be measured with the previous test rig (Figure 5a). Each curve, as shown in Figure 6, describes the rate of change of the operating pressure versus the inlet pressure, for a nearly steady operating flow rate as referenced on Figure 6. These characteristics give for several mass flow rates the influence of the inlet pressure on the pressure static error.

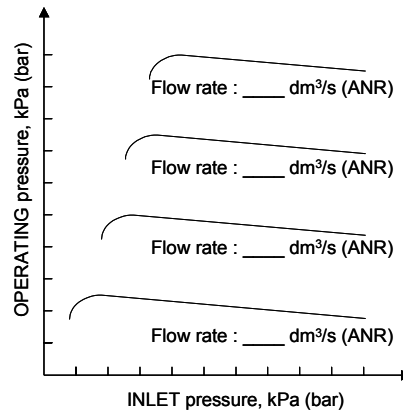

Figure 6 Pressure regulation characteristic curves

Note that the previous flow-pressure characteristics and pressure regulation characteristics are similar to those proposed by the ISO 6953 standard concerning the compressed air regulators and filter-regulators [8].

2.2 Dynamic characteristics

Since the position of the mobile part of the mechanical elements of the pressure continuous control valve can hardly and rarely be measured, two indirect and global tests can be done to characterize the global dynamic behaviour of the component under study: tank charges and discharges, using the test rig shown in Figure 7. Due to the non linear behaviour of the system and in order to give significant information about the valve dynamic, three different sizes of test tank have to be chosen according to the maximal sonic conductance obtained from Eq. 3. The curves, corresponding to the measure of the tank pressure versus time

(Figure 8) for steps of the electrical control signal on its full scale, give then an indication of the valve dynamic performance in different conditions of use.

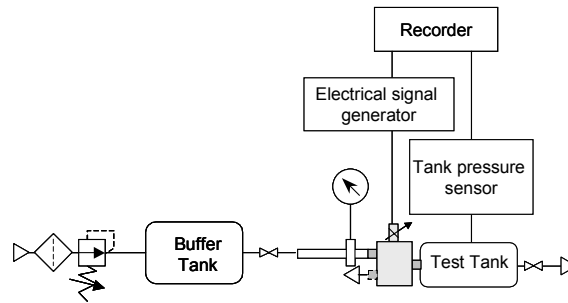
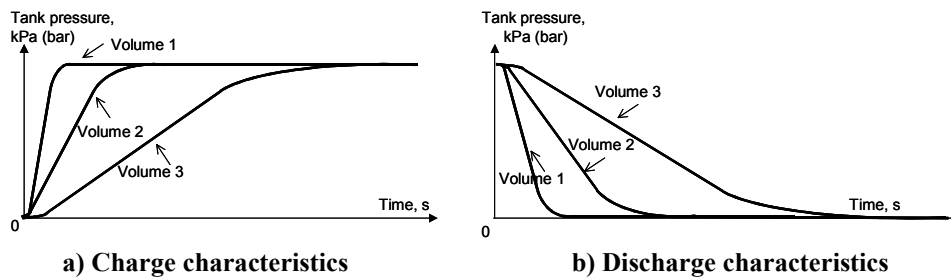

Figure 7 Test circuit for dynamic characterization



a) Charge characteristics

b) Discharge characteristics

Figure 8 Dynamic characteristics

3. ELECTRO-PNEUMATIC FLOW RATE CONTINUOUS CONTROL VALVES

It is important to note that in the case of the electro-pneumatic flow continuous control valves, to the electrical control signal (input control) corresponds the position of the moving mechanical part, which defines the effective variable section of each port of the flow rate stage (output). In order to compare different flow components, their characterisation should consist in evaluating the quality of the relation between these input and output.

But unlike pressure control components, the operating mass flow rate, which is here the output of interest at the user level, is not directly controlled. It results from a superposition of different flows in the valve and it varies with the effective sections reached for a control signal and with the upstream and downstream pressures of each flow path. Moreover the effective variable section of each port (depending on the position of the moving part) is not easily measurable. Several works using stationary flow tests [9] or transitory tests [6] have obtained some results concerning the evolution of the equivalent effective areas of the control valve (for supply flows and for exhaust flows). But these methods are identification procedures, in which the equivalent effective areas is computed using flow measurement and mathematical expressions of the flow issued either from the fluid mechanics theory [9] or from the mathematical approximation of the ISO 6358 standard [1].

Since the main applications of flow continuous control valves are flow regulations, electro-pneumatic positioning systems or force control system, there are advantages to directly measure the operating mass flow rate, the significant output. In a first way to compare different control valves, we propose the use of static flow characterizations. Even if it is easier to characterize only one port, the other one being plugged [10], we propose to measure the global operating flow. This global flow is indeed the real outgoing (supply) or ingoing (exhaust) operating flow through the component. It has to be measured at the operating port, the inlet port respectively the exhaust port being always connected to the supply circuit respectively to the atmospheric pressure according to the normal use of the control valve.

As the operating mass flow rate depends not only on the control input (the electrical control signal) but also on the operating pressure when the inlet and exhaust pressures are kept constant, the static flow characteristics should consist in a 3D-map showing the evolution of the global flow rate according to the electrical control signal and to the operating pressure as shown in Figure 9 [Belgharbi].

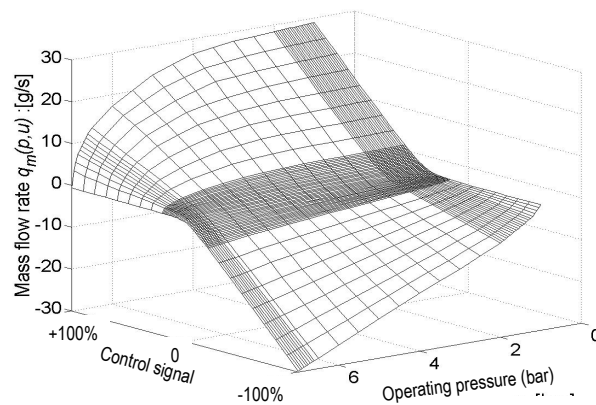

Figure 9 3D-map of the flow rate global characteristic

Such a map is naturally useful for modelling purposes [11, 12, 13], but is not well-adapted when the goal is only the comparison of several components. It is the reason why our proposal is to use two types of flow characteristics corresponding to planar projections of this 3D-map: the first one is the global flow gain characteristic curves and the second one is the pressure-flow global characteristics. These informations give the evolution of the global mass flow rate according to the electrical control signal respectively to the operating pressure when the other variable is kept constant.

It can be noticed that the third planar projection of the 3D-map (Figure 9), which gives the evolution of the operating pressure according to the electrical control signal for different constant mass flow rates can have an interest for flow control valve applications at constant flow rate. The simplest case is obtained for a null flow rate and is interesting when flow control valves are used to control the position of a double acting cylinder with no leakage between the two chambers. Furthermore this particular characteristic called pressure gain

characteristic at null operating flow presents the advantage to be very easily obtained experimentally.

Similarly to the static characterization, the dynamic performances of control valves should be obtained using the operating flow rate as the output, but up to now, mass flow rates cannot be measured by flow meters at high frequencies. Kawashima et al. [6, 7, 15] have proposed to identify the instantaneous flows from pressure measurements during the charge or the discharge of an isothermal chamber. This method enables the identification of the frequency characteristics of the effective area of the flow path. The presented results are naturally very interesting even if their application to frequency characteristics of the global operating flow rate seems to be more difficult to obtain. Actually, to be fully usable, it would require the stabilisation of the flow (and therefore, of the pressure) for any sinusoidal control signal. We propose then to compare the dynamic characteristics of the flow components using the output, which is directly linked to the control signal that is to say generally the position of the moving part.

In conclusion, our proposal for evaluating the quality of the flow control valve consists in the following minimal set of data or characteristics:

- the pressure gain characteristics at null operating flow. The shape of the characteristic curve (linear or not), its hysteresis value and its slope are relevant parameters for applications such as positioning systems. They have actually a direct influence on the static positioning performances, and especially on the stability of the steady state of the positioning system [16, 17].
- The leakage flow characteristic curve at null operating flow. Its shape and particularly its maximal value give information concerning the air consumption of the component at null operating flow.
- The global flow gain characteristic curves. The two curves, measured for an operating pressure equal to the atmospheric pressure respectively to the inlet pressure, define the admissible working domain of the component at a given inlet pressure when the operating pressure varies between inlet and exhaust pressure values. A third curve obtained for the operating pressure equal to the inlet pressure minus 100kPa enables the eventual non linearity of the flow rate to be pointed out according to the control signal (due mainly to a non linear evolution of the equivalent effective area along the flow path).
- The network of pressure-flow global characteristic curves. These curves show the influence of the control signal on the flow parameters determined according to the ISO 6358 [1], i.e. on the sonic conductance corresponding to the equivalent effective area and on the critical pressure ratio.
- Finally, the dynamic characteristics, consisting in both frequency responses and step responses. They are useful to compare the component responses to changes in the control value. These characteristics are obtained from the measurement of the position of the moving part for different magnitudes due to the high non linearity of the component behaviour.

We will limit here our proposal to three-port flow continuous control valves, but it can be obviously extended to five-port components.

3.1 Static characteristics

3.1.1 Pressure gain and leakage flow characteristics at null operating flow rate

The pressure gain characteristic corresponds to the hysteresis curve (Figure 10a), which gives the measured operating pressure, at null operating flow rate and constant inlet pressure, versus the electrical control signal when this last one is varying in both directions on its full scale. The hysteresis value is calculated identically as in Fig. 1b using Eq. 2. The used test rig (Fig. 11) is identical to the rig previously presented in Fig. 2, except for the additional flow meter placed upstream the supply line in order to measure the component leakage. This means that the evolution of the leakage flow rate at the inlet port according to electrical control signal can be measured simultaneously to the pressure gain characteristic at null operating flow rate.

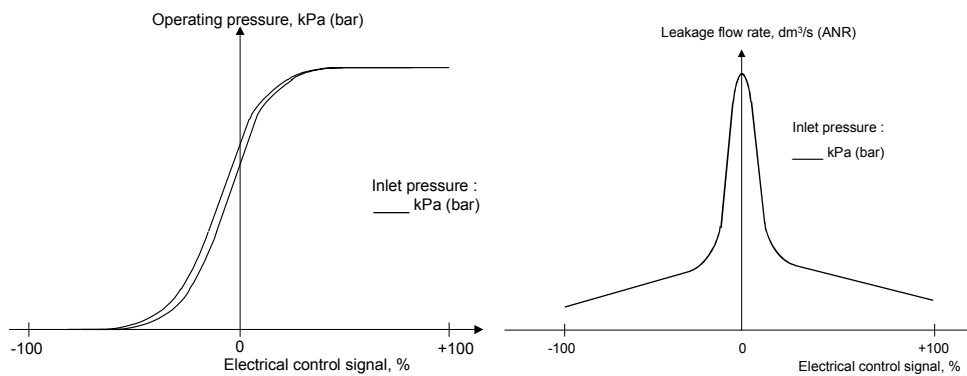

a) Pressure gain characteristic curve

b) Leakage characteristic curve

Figure 10 Static characteristic curves at null operating flow rate

3.1.2 Global flow characteristics

The global flow characteristics can be obtained by stationary measurements, using the same test rigs as in the case of pressure control valves: Figure 5a for the supply flow rates and Figure 5b for the exhaust flow rates. The convention is to have supply flows corresponding to positive values of the operating flow and exhaust flows to negative values as shown on Figures 11 and 13.

A global flow gain characteristic curve shows the evolution of the operating flow rate when the electrical control signal is changed in both directions on its full scale, for given operating and inlet pressures. We propose here to determine experimentally the two curves delimiting the operating flow range according to the minimum and the maximum operating pressures, i.e. from the exhaust pressure (P_e) to the inlet pressure (P_i). A third curve has to be measured for an intermediary operating pressure equal to the inlet pressure minus 100 kPa (usual conditions for determining the nominal flow rate [18]). Note that when the flow gain curve is measured for an operating pressure equal to the exhaust pressure, a simplified test rig (Figure 12) is used.

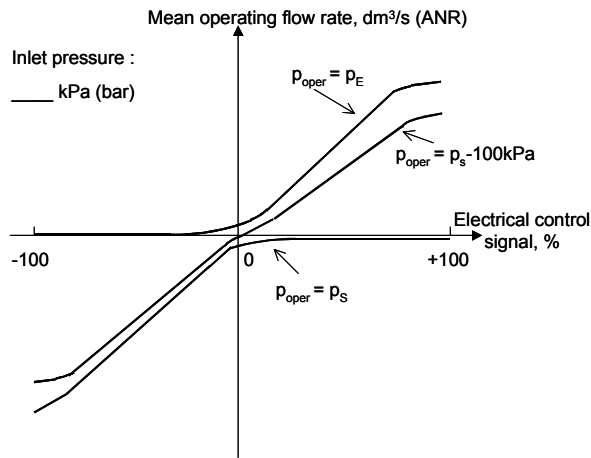

Figure 11 Global flow gain characteristic curves

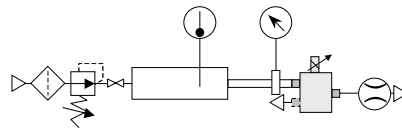

Figure 12 Test circuit for characterising flow rate gain with operating port connected to atmosphere

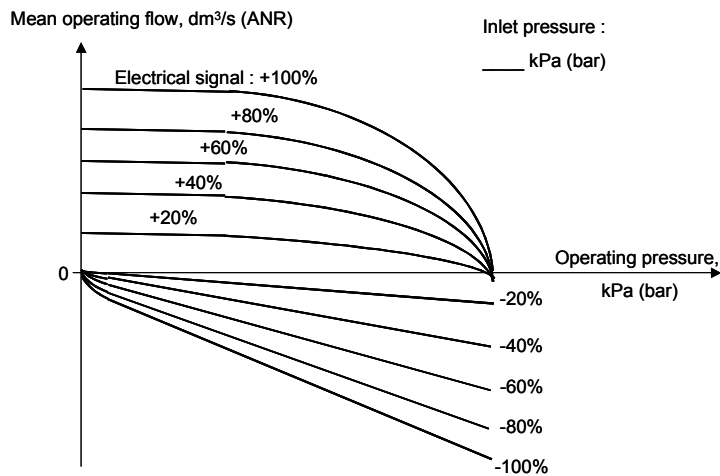

Figure 13 Pressure-flow global characteristics

A pressure-flow global characteristic curve describes only the operating flow rate evolution according to the operating pressure, for a given constant electrical control signal. To determine the influence of the control signal, a network of curves is required. It can be

obtained by making the measurements for several electrical control signal values, as referenced in Figure 13. Because the flow path corresponding to a given control value does not correspond to a single restriction but to a complex network of restrictions, it is generally difficult to determine the flow parameters (sonic conductance C , critical pressure ratio b) according to the ISO 6358 standard [1]. However, with the extension of the mathematical flow expression proposed by Kagawa et al. [19], and particularly with the flow parameter m , and eventually with the cracking ratio parameter a , the determination of the 4 flow parameters (b , C , a , m) as a function of the control signal is easier. But this can be used only for high control signal values (greater than 20% of the maximal value) for which one restriction along the flow path becomes predominant compared to the others.

Note that these pressure-flow global characteristic curves could be obtained using transitory tests through the charge or a discharge of a tank of an adequate volume to be sure that the flow is well-established at each sampling time. However the global flow gain characteristic curves cannot be obtained from transitory tests since the three port pressures has to be kept constant.

3.2 Dynamic characteristics

For the dynamic characterization of electro-pneumatic flow rate continuous control valves, the position measurement can be given by the internal position sensor of the component, if it owns one, otherwise, it will be necessary to add an external position sensor, taking care that the implementation of such a sensor does not modify the dynamic characteristics.

A typical test circuit for the dynamic characterization of electro-pneumatic flow rate three-port continuous control valve is described in Figure 14. The buffer tank is used to limit inlet pressure fluctuations and it has to be placed as close as possible to the device inlet port.

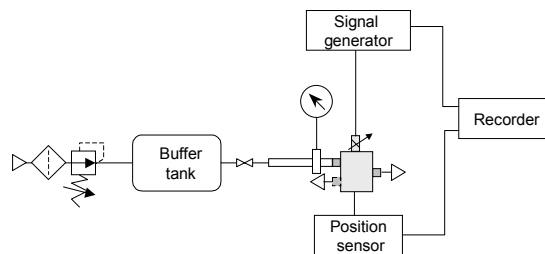

Figure 14 Test circuit for dynamic characterization

Dynamic characterization consists on one hand in classical frequency responses as shown in Figure 15 and on the other hand in step time responses as shown in Figure 16.

Due to the non linearity of the system, it is necessary to determine the frequency responses for at least 3 different control signal amplitudes ($\pm 5\%$, $\pm 50\%$, $\pm 90\%$) plotted in bode diagrams as shown in Figure 15. From these curves, the cut frequencies at -3dB and at -90° are identified enabling the comparison of flow control valves.

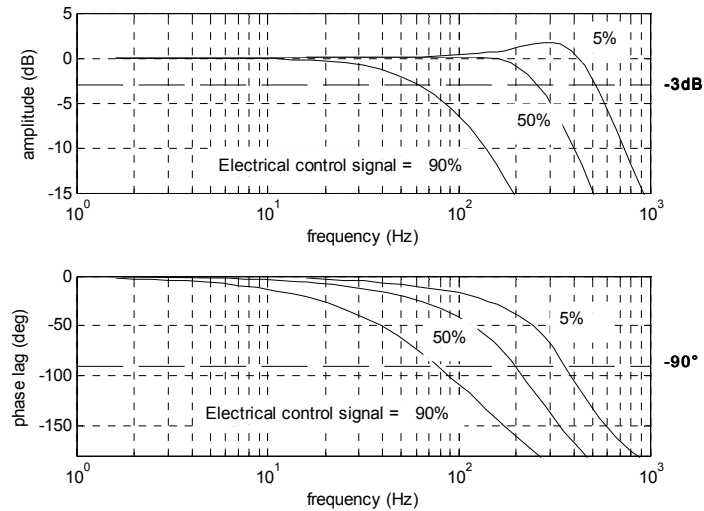
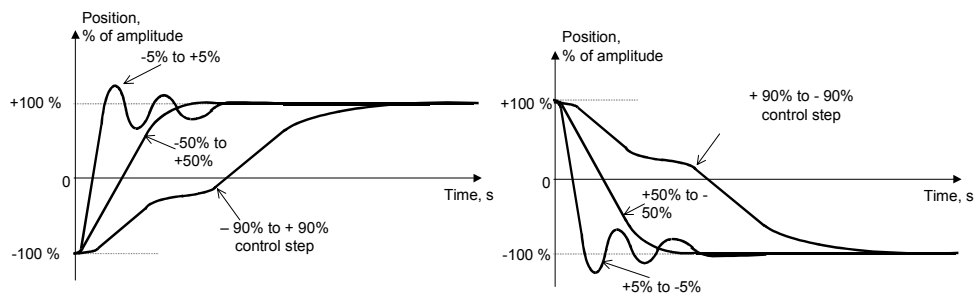

Figure 15 Frequency responses

In order to compare dynamic characteristics of control valves, it is also possible to record the time response of the position of the moving part to electrical signal steps. As the electromechanical system is non linear, a complete comparison requires several step responses for at least 3 sets of control signals on each side of the median value (0%): 5%, 50% and 90%. They can be classified in 3 groups where:

- Step responses shown in Figure 16a are corresponding to control signal steps centred on the median value of the signal,
- Step responses shown in Figure 16b are corresponding to control signal steps from the median value of the signal,
- Step responses shown in Figure 16c, corresponding to control signal steps towards the median value of the signal.



a) Step responses to control steps on both side of the control signal median value

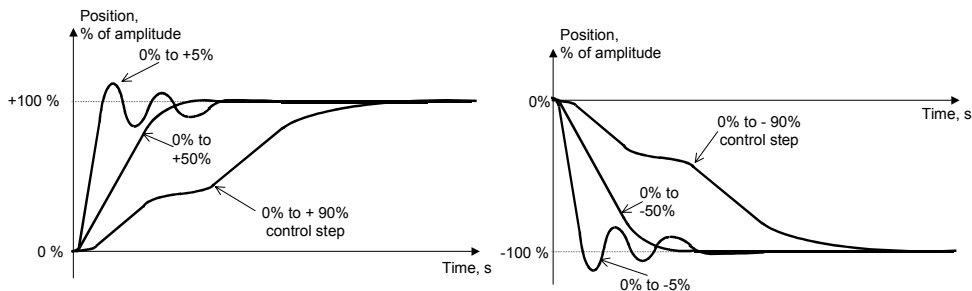

b) Step responses to control steps from the control signal median value

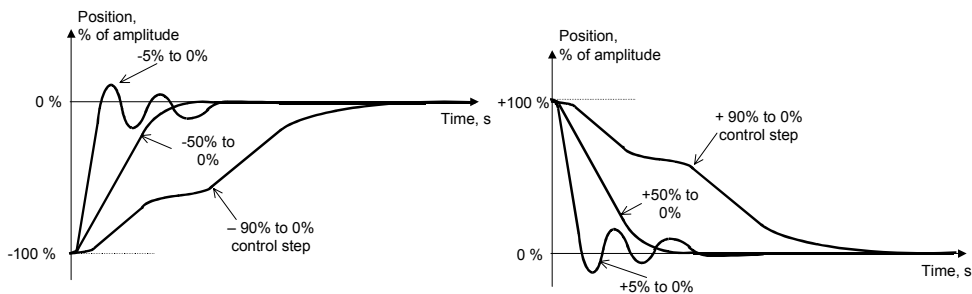

c) Step responses to control steps from the control signal median value

Figure 16 Dynamic characteristics

4. CONCLUSION

The aim of this work was to set up a proposition pointing out characteristic data useful to compare electro-pneumatic continuous pressure and flow control valves in order to help user choice at the design stage of a pneumatic system. As it is usually the user main concern, this proposal focused on the evaluation of the quality of the relation between the input (the electrical signal) and the useful output of the component (operating pressure or global operating flow rate) using static characteristics as well as dynamic ones.

Another purpose of this work was also the definition of the experimental procedures to apply in order to obtain the different characteristics. Our main goal was also here to simplify and to limit the required equipment. Although other procedures are available, we have preferred to use procedures based on the ISO6358, in which static characteristics are obtained using stationary measurements. Some remarks have been introduced in the paper when other methods can be applied, such as measurements in transient conditions. It is surely conceivable, that, shortly, this last procedure can be adapted to fasten the component characterisation, to make easier the measurement of large flow components, or to obtain directly flow frequency characteristics.

Acknowledgment

The authors wish to thank the French Technical Centre of Mechanical Industries (CETIM) for its financial support and its collaboration during this work. This work has led to the proposal at the International Standard Office (ISO) of a standard project in 6 parts that is followed through by the French Standardization Office for the mechanical engineering and rubber industries (UNM).

REFERENCES

1. International Standard ISO 6358. Pneumatic Fluid Power - Components using Compressible Fluids – Determination of Flow-rate Characteristics, 1989. 15p.
2. Oneyama, N., Takahashi, T., Terashima, Y., Kuroshita, K. and Kagawa, T., Study and suggestions on flow-rate characteristics of pneumatic components, 7th Symposium on Fluid Control, Measurement and Visualization, 2003
3. K. Kawashima, Y. Ishii, T. Funaki, and T. Kagawa. Determination of flow-rate characteristics of pneumatic solenoid valves using an isothermal chamber. Transaction of the ASME, Journal of fluids Engineering, vol. 126, March 2004, pp 273-279
4. Sesmat, S., Scavarda, S. Static characteristics of a three way servovalve. In: 12th Aachen Conference on Fluid Power Technology, Aachen, Allemagne, March 12-13, 1996, p 643-652.
5. Peng G., Chai, X., Fan, W., A new measurement method of the flow-rate characteristics of the regulator, Proceedings of the 6th JFPS International Symposium on Fluid Power, Tsukuba 2005, November 7-10, 2005, Paper 3C2-4, pp 766-770
6. Kawashima, K., Fujita, T., Kagawa, T., and Jang, J., Characteristic measurement of pneumatic flow control valves using isothermal chamber. 10th Bath International Fluid Power Workshop, Challenges and Solutions, 10-12 september 1997
7. Kawashima, K., Fujita, T., Kagawa, T., Jang, J. Characteristics measurement of pneumatic elements using isothermal chamber. Proceedings of the 3rd JHPS Int. Symposium on Fluid Power, Yokohama'96, Paper n°204, pp 253-258
8. International Standard ISO 6953-1. Pneumatic Fluid Power – Compressed air regulators and filter-regulators, Part 1: Main characteristics to be included in literature from suppliers and product-marking requirements, 2000.
9. Det, F., Scavarda, S., Richard, E. Simulation of an electropneumatic servovalve to study the feasibility of a position control loop. In: Fluid power Transmission and Control, proceeding of the 2nd int. Conf., Hangzhou (China), March 20-22, 1989, Beijing : International Academic, pp 505-510
10. Fernandez Jiménez, A., Pérez Garcia, J., Compressible bench flow adaptations to the experimental characterization of pneumatic components. Application to the determination of flow-rate characteristics of a MPYE-5-3/8-010-B proportional valve, Proceedings of the 3rd FPNI-PhD Symposium on Fluid Power, Terrassa, Spain, June 30-July 2, 2004
11. Belgharbi, M., Thomasset, D., Scavarda, S., Sesmat, S., Analytical model of the flow stage of a pneumatic servo-distributor for simulation and nonlinear control, in the Sixth Scandinavian International Conference on Fluid Power, SICFP'99, Tampere, Finland, May 26-28, 1999, pp847-860.

12. Kaasa, G. O., Chapple, P. J., Lie, B. Modeling of an electro-pneumatic cylinder actuator for non linear and adaptive control, with application to clutch actuation in heavy-duty trucks, Proceedings of the 3rd FPNI-PhD Symposium on Fluid Power, Terrassa, Spain, June 30-July 2, 2004, pp255-273
13. Sorli, M., Figliolini, G., Pastorelli, S., Rea, P., Experimental identification and validation of a pneumatic positioning servo-system, In Power Transmission and Motion Control, PTMC'05, Sept. 2005, pp 365–378.
14. Olaby, O., Brun, X., Sesmat, S., Redarce, T., Bideaux, E., Characterization and modeling of a proportional valve for control synthesis, in the 6th JFPS International Symposium on Fluid Power, Tsukuba, Japan, November 7-10, 2005, pp 771-776.
15. Kawashima, K., Kagawa, T., and Fujita, T., Instantaneous Flow Rate Measurement of Ideal Gases, Transaction of ASME, Journal of Dynamic Systems, Measurement and Control, vol. 122, march 2000, pp 174-178
16. Sesmat, S., Scavarda, S., Study of the behaviour of an electropneumatic positioning system near the equilibrium state. 1 Int. Fluid. Kolloq. in Aachen, Aachen, 17-18 Marz, 1998, vol. 2, p 321-334.
17. Brun, X., Sesmat, S., Thomasset, D., Scavarda, S., Study of sticking and restarting phenomenon in electropneumatics, Journal of Dynamic Systems Measurements and Control, Vol 127,N°1, March 2005, pp 173-184.
18. Scholz, D., Auslegung servopneumatisher Antriessysteme. Dissertation RWTH, Aachen, 1990, 231p.
19. Kagawa, T., Cai, M., Kawashima, K., Wang, T., Nagaki, T., Hasegawa, T., and Oneyama, N.. Extended representation of flow-rate characteristics for pneumatic components and its measurement using isothermal discharge method. In Power Transmission and Motion Control, PTMC'04, pages 271–282, Sept. 2004.