



**HAL**  
open science

## Tools dedicated to the Electromagnetic Modelling of Power Structures

Vincent Ardon, Edith Clavel, Olivier Chadebec, Enrico Vialardi, Jean-Michel Guichon, Jean-Luc Schanen, Patrice Labie

► **To cite this version:**

Vincent Ardon, Edith Clavel, Olivier Chadebec, Enrico Vialardi, Jean-Michel Guichon, et al.. Tools dedicated to the Electromagnetic Modelling of Power Structures. Automotive Power Electronics 2009, 2009, Paris, France. hal-00367111

**HAL Id: hal-00367111**

**<https://hal.science/hal-00367111v1>**

Submitted on 10 Mar 2009

**HAL** is a multi-disciplinary open access archive for the deposit and dissemination of scientific research documents, whether they are published or not. The documents may come from teaching and research institutions in France or abroad, or from public or private research centers.

L'archive ouverte pluridisciplinaire **HAL**, est destinée au dépôt et à la diffusion de documents scientifiques de niveau recherche, publiés ou non, émanant des établissements d'enseignement et de recherche français ou étrangers, des laboratoires publics ou privés.

# Tools dedicated to the Electromagnetic Modelling of Power Structures

V. Ardon<sup>1,2</sup>, E. Clavel<sup>2</sup>, O. Chadebec<sup>2</sup>, E. Vialardi<sup>1</sup>, J.M. Guichon<sup>2</sup>, J.L.Schanen<sup>2</sup>, P. Labie<sup>2</sup>

1: Cedrat, 15, Chemin de Malacher - inovallée, F-38246 Meylan Cedex

2: G2elab, BP 46, F-38402 Saint Martin d'Hères Cedex

**Abstract:** The aim of this article is to propose a modelling environment including several simulation tools which allows evaluating the electrical parasitic characteristics of components, the current distribution inside power electronics structures or the radiated field. At the end, it is then possible to conclude upon the EMC performances of power converter with its environment inside a complete structure which can be an automotive system and to achieve an expertise of the design.

**Keywords:** Finite Element Method, Integral methods, Electrical simulation, EMC, modelling environment

## 1. Introduction

The modelling purpose inside a vehicle is becoming more and more complex. Traditionally, modelling tools are dedicated to one specific issue which can be the study of the cables themselves or one electrical motor or one power converter.

But today this is not enough. Not only the technologies used but also the required standard and the desired performances transform these single "uniphysic" problems into a "multiphysic" one.

Consequently, the study of the device inside its environment is unavoidable. This implies necessarily a strong dialogue between the different kinds of model and the associated methods.

The aim of this article is to present the modelling process which can be followed to model the EMC performances of a power converter inside a vehicle, trying to take into account as many parameters as possible.

First, in section II, several modelling methods with their associated application fields are presented: their main advantages and drawbacks are also listed and discussed. In section III, examples of industrial tools and their specific applications are presented. Some couplings between modelling methods are envisaged, allowing the introduction and, in section IV the detailed presentation of a complete modelling environment. That way a complete industrial system can be modelled using it.

## 2. Dedicated modelling methods

As said above, the electromagnetic modelling of a complete system including for example a power converter inside a vehicle requires specific tools.

Depending on the studied part of the system, the mathematical method and the associated model are not the same. In this part an overview of the existing models and methods is achieved.

### 2.1 The Finite Element Method

The very well known Finite Element Method (FEM) is useful to evaluate the electromagnetic fields of a complex complete structure. It is based on the volume mesh of the whole device and the surrounding air region. Nevertheless, it requires to mesh not only the medias (conductive, magnetic or dielectric), but also the air between them and some free space surrounding the system.

Consequently, its use to achieve a complete modelling of a whole vehicle including all the electrical functions, battery, accessories, and so on is unrealistic because of the high number of unknowns needed for the meshing of this very large problem. On the other hand, FEM method is unavoidable when magnetic materials (for example, the iron or the steel of the car chassis and the magnets of an electrical motor) are included in the structure. For these reasons, the industrial tool Flux® which is based on the FEM and which has proved its efficiency for electrical design [1] has been used in this work for modelling a synchronous motor (see paragraph 3.6 below).

It is worth to note that the results concerning the electromagnetic fields can be translated into currents or electrical circuits in order to be exported towards electrical simulators such as PSPICE, Saber or Portunus.

### 2.2 The integral methods

With integral methods, it is not necessary to mesh all the space around the device. Only conductors have to be taken into account and so when the air region is dominant (for interconnection between components for instance), the method is particularly attractive. Their use becomes interesting and very efficient. However, at the present time, to model accurately magnetic materials is still difficult.

The Partial Element Equivalent Circuit (PEEC) method is one of the integral methods which can be applied. It is very well adapted to model every kind of metallic conductors inside a complete structure [2],

because it is able to attribute to each part (element) of the electromagnetic system an equivalent circuit made of a resistance and inductances (self and mutual). In order to take into account the shape of the structure and the proximity and skin effects, a meshing of the conductors is however necessary, but for interconnection systems, the number of unknowns is very limited compared to the FEM.

In order to expand the frequency range of the (R, L) PEEC circuit, it is also possible to include parasitic capacitances computed by a dedicated integral method [4] or the Adaptive Multi-Level Fast Multipole Method (AMLFMM).

In any case, the associated model is a large electrical equivalent circuit including resistances, inductances and mutual inductances which is frequency dependent. The commercially available tool InCa3D® is based on this method and was already widely used to model power electronics structures [5].

On one hand, solving the Kirchhoff's equations of the obtained circuit makes it possible to evaluate the current distribution inside structures like a power distribution system for instance. The near radiated field can be deduced by using Biot and Savart's law and then the electrodynamics effort by the Laplace's law. Or on the other hand, by reducing the electrical circuit, it is possible to obtain equivalent impedances of connections which can be then exported towards electrical simulators, such as PSPICE, Saber or Portunus, for performing system level computations.

### 2.3 The system simulation

As presented above, most of the times, it is necessary to export the results of FEM or PEEC methods in order to achieve a system simulation, because a complete power electronics structure is made of passive (wires, PCB, ...) and active (diodes, transistors, ...) components. The first ones can be modelled using PEEC or FEM approach, whereas the behaviour of active components needs to be modelled separately with specific non-linear techniques: some libraries are available according to the simulation tool used. Usually for power electronics applications simulation tools such as PSPICE, Saber or Portunus are suitable. Depending on the computed data or the system under study, the designer will use one of them.

PSPICE is well adapted when current and voltage waveforms are computed with standard components. Concerning Saber, it is possible to program a specific component or behaviour provided that the Mast language is known.

As regards Portunus®, the interest lies in the different modelling approaches (block diagrams, networks, state machines...) that can be combined to reach easy and accurate system simulation. Both

networks and block diagrams being solved with the same continuous solver, convergence is reached faster than with other solvers. Existing libraries feature among others electrical, mechanical, thermal and power electronics models and can be enriched by Spice netlists or VHDL-AMS models [3].

## 3. Some Applications

In this paper, the previous modelling methods have been successfully used in order to characterize industrial structures.

Depending on the studied data, only one modelling method is used or a coupling between some of them is required. This can be a simple modelling chain or a strong coupling: this alternative is deeply linked with the available simulation tools.

In this section, an overview of the possible computations using the previously presented methods and tools is achieved.

### 3.1 Equivalent impedances

The first example concerns the electrical modelling of the connections inside a power electronic module. This studied device (600V – 75A nominal current) is a complete three phase inverter including six control pins and multiple pins for power connections. It is designed for AC motor control, and its maximum switching frequency is 20 kHz. It contains twelve semiconductor components (six IGBT and six free-wheeling diodes) to perform six switch functions (Fig. 1). Geometry of pins, wire bonds, DBC substrates, as well as the heat spreader are described into InCa3D in order to apply PEEC method. Even if the heat spreader does not have any electrical connection with the rest of the module, it acts on it like a ground plane. It has therefore an influence on the self and mutual inductances of the other conductors situated close to it. Figure 2 shows the InCa3D description.

The InCa3D model is then an electrical circuit constituted by a lot of R, L and M which can be written as matrices ([R] and [L]).

A first use of this model could be to reduce the sizes of these matrices in order to obtain equivalent impedances from the outputs of the device which have been identified by the designer.

Indeed this last model is frequency-dependent.

On Figure 3, the equivalent impedance of one electrical loop of the power module has been identified. Measurements have been done on the real device and results are presented on Table I. A good agreement can be observed assuming that it can be difficult to obtain precise measurements [5].

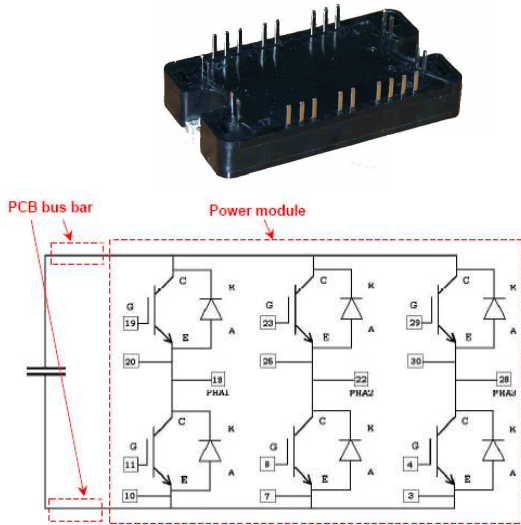

Figure 1: The studied power module with its electrical function

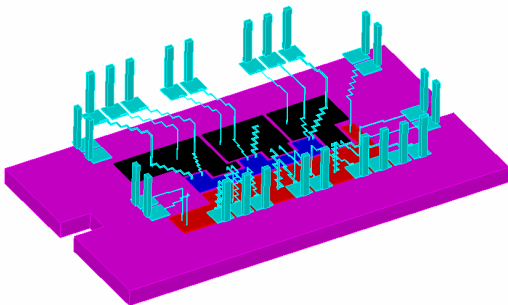

Figure 2: View of the InCa3D model of the power module

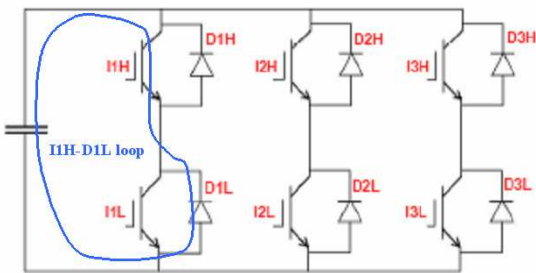

Figure 3: I1H-D1L loop on the power module electric diagram

Table I: Measurement and simulation values for I1H-D1L loop inductance

	Measurements	InCa3D
Inductance of loop I1H-D1L	75 nH	71.5 nH

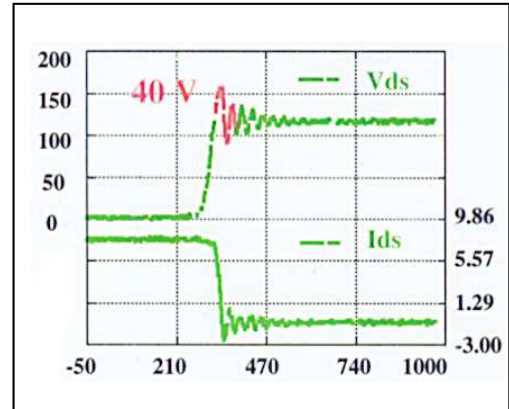

Figure 4: Measure of Vds in a chopper structure – Over voltage

This value of inductance can be very critical since it is strongly linked to the overshoot of drain-source voltage occurring during commutation ( $Ldi/dt$ ). This over voltage can lead to a bad working of the power structure. It can reach unacceptable values for the structure such as 40V on the example presented on Figure 4 which represents a third of the Vds waveform.

### 3.2 Current densities and losses

Considering a power electronic structure or a power electrical system, it is composed of passive components, active components and layout.

If there is no magnetic material, the layout can be modelled using PEEC method via InCa3D and an electrical equivalent circuit can be deduced. Knowing how it is supplied, the solving of the associated Kirchhoff's equations leads to the evaluation of current inside each cell of the PEEC meshing. Then the current distribution can be deduced. Using a circuit analysis, the global currents at the outputs of the structure can be computed as well as the global losses due to the resistive contribution of the conductors.

The following example of a three phase power distribution system with six conductors per phase (Fig. 5) has been modelled using this process [6]. On Figure 6 the current distribution at the frequency of 50 Hz is displayed. This last result allows emphasizing the proximity and skin effects. Hence according to the geometrical position of conductors, the current density will not be uniform in the conductor section which implies that the conductive material is badly used and additional Joule losses are generated.

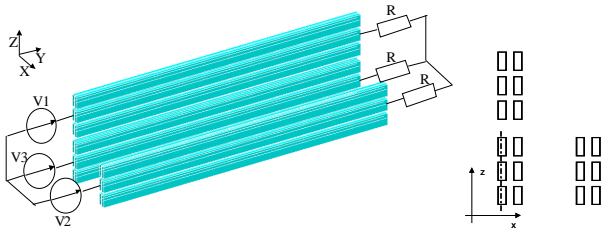

Figure 5: A three phase power distribution system

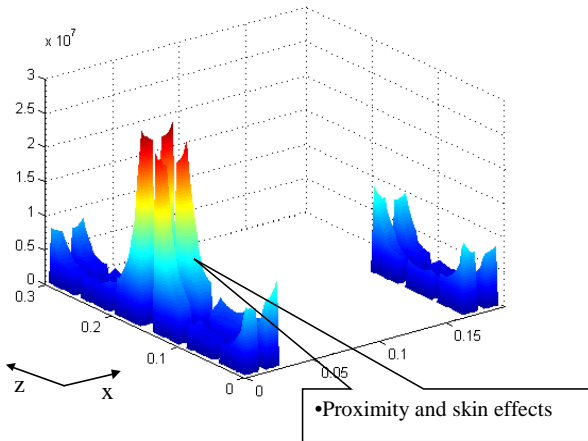

Figure 6: Current density inside the conductors

On Table II, these additional undesirable losses of each phase have been calculated.

Table II: Losses of each phase

	Losses (W)
Phase 1	222
Phase 2	158
Phase 3	233
Total	613

From the complete electrical equivalent circuit, it is possible to evaluate currents and losses for continuous conditions (frequency=0Hz) as well as for a single phase. That way, it is possible to know the losses due to skin effect and proximity effect as well as the minimum additional losses due to conductors (Table III).

Table III: Losses according simulation conditions

Simulation Conditions	Losses (W)	Ratio
Continuous	346	1
Skin effect only	366	1.058
Skin and proximity effects	613	1.77

Since currents are available everywhere in the conducting parts, it is then possible to identify the geometrical zones where current density is the highest. Indeed this will imply that these parts could be "hot" points considering thermal aspect.

To confirm this point, thermal modelling can be undertaken on the basis of the losses to dissipate

and assuming that all the thermal exchange coefficients are known. Some can use Icepak® for example to achieve this evaluation.

### 3.3 Radiated magnetic field computations

The two previous examples have proven that thanks to PEEC method and its InCa3D implementation, current and current density inside each mesh are computed. Using Biot and Savart's law, it is then possible to evaluate the magnetic field everywhere in the space due to these currents. Hence the contribution of the structure's conductors on the total magnetic field radiated by the whole structure can be evaluated.

The example of a simple power electronics structure is presented on Figure 7. This is a buck chopper converter for which two major current loops have been identified.

Using our approach, the magnetic field has been computed with InCa3D tool and also measured thanks to a process using magnetic probes [7]. Comparisons are presented on Figure 8. A good agreement can be observed and allows us concluding upon the effectiveness of our modelling approach.

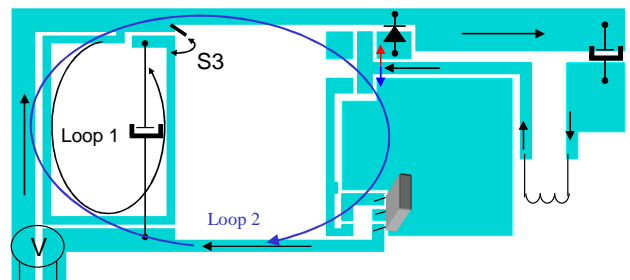

Figure 7: Layout of the buck chopper converter

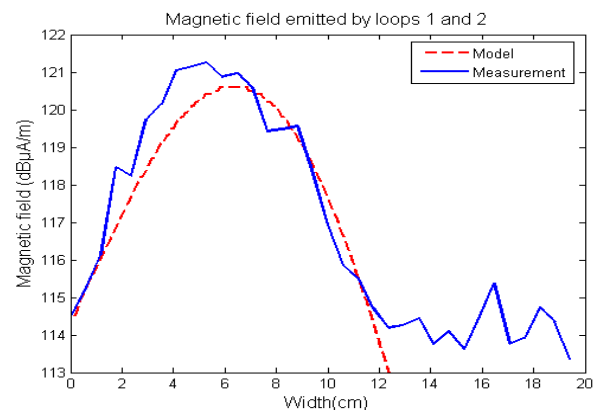

Figure 8: Calculated and measured magnetic field radiated by the structure

When the structure contains magnetic material, it is

not possible to simply use the PEEC method. Some extensions of it have been proposed [8] but sometimes, according to the geometry of the device, FEM is still the best-adapted method [9].

Figure 9 shows a three phase inductor which has been described and modelled using Flux: it is composed by a toroidal core of ferrite and three wires wound on it. As said before, the magnetic field around the structure is efficiently deduced from this modelling. The results are presented on Figure 10.

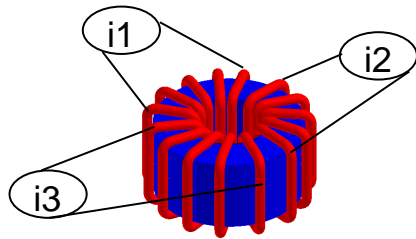

Figure 9: A three phase inductor

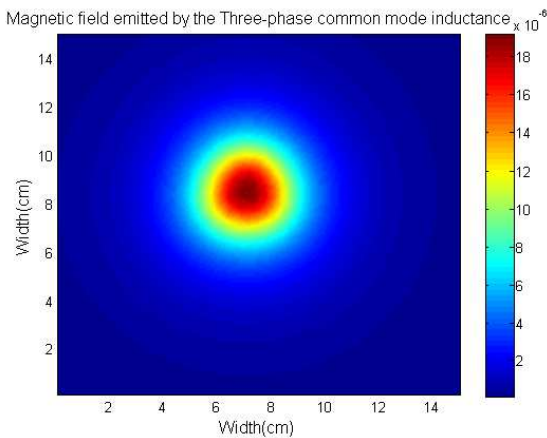

Figure 10: Magnetic field above the three phase inductor

When there are both conductors and magnetic materials inside the studied structure, PEEC approach as well as FEM method can not be used alone, but they need to be jointly used with the aim of exploiting their respective advantages and overcoming their weaknesses.

Moreover, computing the magnetic field radiated by the structure just by doing a simple superposition of the contributions of conductors and of magnetic parts is wrong. It has been shown on a power electronics converter (a common mode filter) including the previous three phase inductor [9] (Fig. 11).

Firstly, the magnetic fields radiated by the layout and by the inductor have been evaluated separately by using the PEEC approach and the FEM tool (Flux) respectively. Then these two obtained fields have

been added and compared to the field radiated by the structure considered as a whole (i.e. layout and inductor). To this aim a coupling between the two methods has been developed [10]. As shown on Figure 12, results are not the same and justify the need of a strong coupling between the two modelling methods.

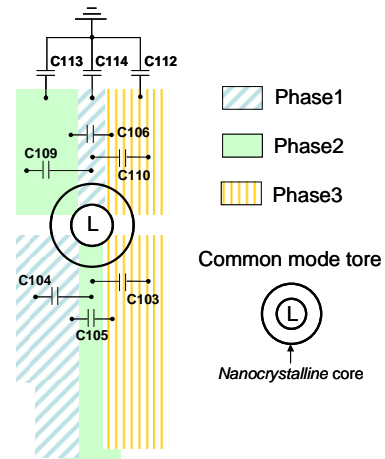

Figure 11: Sketch of the common mode filter

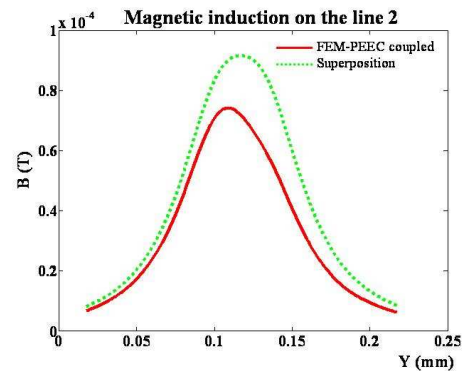

Figure 12: Magnetic field on a line above the structure

### 3.4 Electrodynamics efforts

Previous paragraphs have shown the interest of using PEEC method and its implementation in InCa3D for the evaluation of current, current density and magnetic field. Besides, by using Laplace's law, it is finally possible to calculate to electrodynamic efforts assuming that no magnetic materials are inside or near around the studied structure. In fact, generally, these efforts are usually not critical criteria except in case of high currents due for example to a short circuit default.

Once the density of electrodynamic efforts is evaluated, it is possible to conclude upon the mechanical performances of the studied structure.



Thus the results obtained using PEEC approach have to be introduced inside a mechanical tool which lays on finite elements description. For that it is necessary to know all the external mechanical conditions.

This evaluation has been achieved using Abaqus® [11] on a simple bus bar which can be used to supply power modules (Fig. 13). The case of a short circuit default has been modelled and on Figure 14, the distortion of the copper plate is viewed.

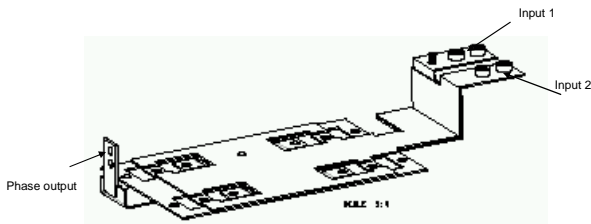

Figure 13: Bus bar geometry

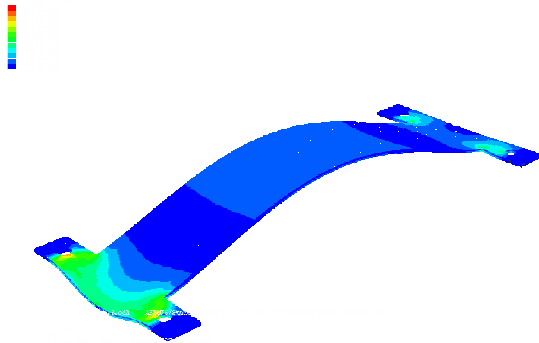

Figure 14: Abaqus simulation: mechanical distortion

### 3.5 Electrical circuit and time-domain waveforms

The available model after a PEEC modelling is an electrical equivalent circuit. This PSPICE-like network can contain lots of passive components (R, L, M and C). As said before it can be reduced directly inside InCa3D to give equivalent resistive and inductive impedances. This can be the final step of PEEC modelling, but on the other hand an automatic export of this impedance matrix from InCa3D to simulation tools like PSPICE, Saber or Portunus makes it possible to include the cabling model within circuit simulation. This enables transient analysis of the complete circuit. The current and voltage waveforms can be deduced provided that the right models of active components or sources are available.

Considering the boost converter of Figure 15, the obtained reduced inductive matrices have been transferred towards Saber. In parallel, a measurement methodology, by means of impedance analyser, has been used to evaluate twelve major parasitic capacitances of a real mock-up of the boost

converter [12]. Comparisons with a FEM (Flux), an adapted integral method (MoM) and a FMM, validate the computation of these capacitances (Table IV) [4].

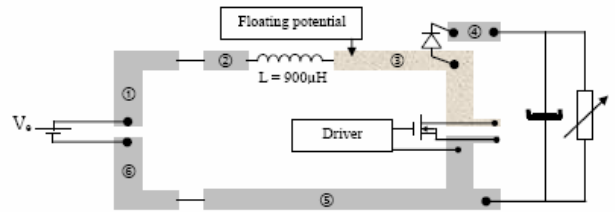

Figure 15: Boost converter topology

Table IV: Measured and computed capacitances

Capas (pF)	C17	C27	C37	C47	C57	C67	C12	C23	C34	C53	C65	C16
Mesure	1,53	1,25	2,95	0,87	6,50	1,57	0,92	0,70	1,12	1,26	0,93	0,98
MoM	1,77	1,30	2,72	0,88	5,28	1,72	0,34	0,08	0,89	1,36	0,38	0,49
FMM	1,76	1,28	2,70	0,88	5,27	1,73	0,31	0,08	0,89	1,35	0,35	0,47
FEM	1,90	1,40	2,92	0,93	5,67	1,84	0,25	0,06	0,80	1,10	0,27	0,40
% MoM/Mesure	15,7	4,00	7,80	1,15	18,8	9,55	63,0	88,6	20,5	7,94	59,1	50,0
% FMM/Mesure	15,0	2,47	8,57	0,64	18,8	10,3	66,3	89,2	20,1	7,17	62,7	51,5
% FEM/Mesure	24,2	12,0	1,02	6,90	12,8	17,2	72,8	91,4	28,6	12,7	71,0	59,2

By adding parasitic capacitances to the resistive and inductive circuit, a more complete equivalent circuit is obtained and described in the Saber environment. In order to compute the conducted EMI, the converter is connected to load and to power supply through a Line Impedance Stabilisation Network (LISN) (Fig. 16).

The commutations of the transistor generate common mode currents which develop between copper tracks and the ground plane through parasitic capacitances. Simulations are compared to measurements in Figure 17 and shown good agreements. Different equivalent circuits have been tested: an equivalent circuit with all calculated capacitances, another with only the twelve measured capacitances (less complex), another with only one evaluated capacitance connected to the high DV/DT point of the circuit.

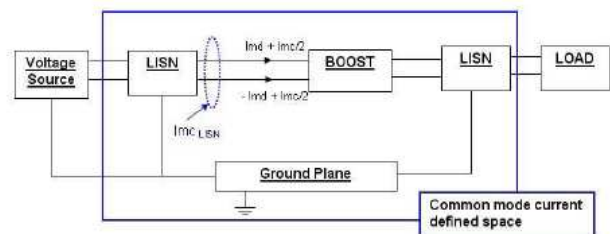

Figure 16: Modeling of common and differential mode current

The FFT of common mode current provides conducted EMI simulation and the results of the study undertaken with the power module are presented on Figure 18. This one shows the importance to take into account accurate capacitive

effects at high frequencies. This allows concluding upon the EMC performances of the structure.

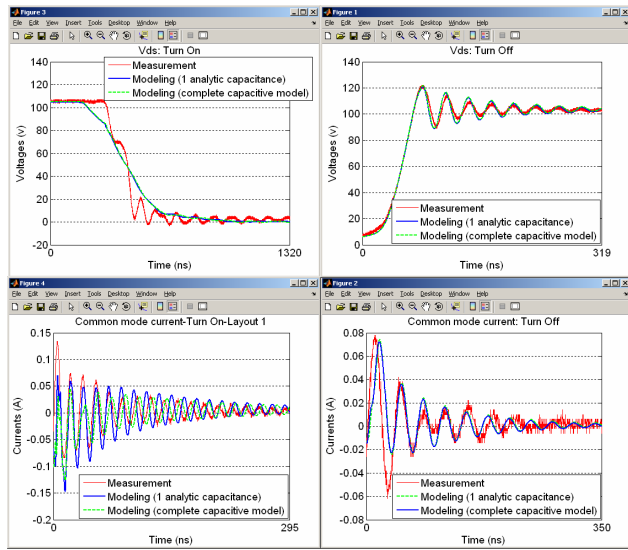

Figure 17: Drain-Source Voltage and common mode current

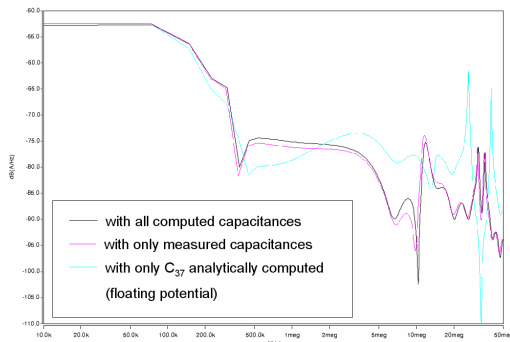

Figure 18: common mode current spectrums (Turn Off) obtained with circuit simulations

Another example on Figure 19 shows that it is feasible to predict the possible unbalance between several power components connected in parallel [13]. On this example of rectifier, due to the high current, the switch function is realized using four parallel diodes.

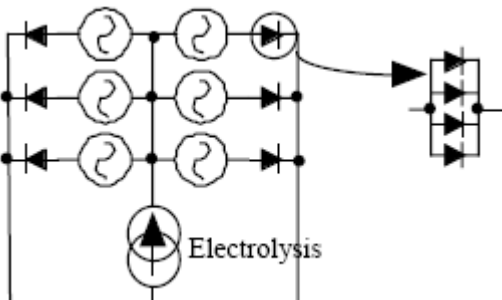

Figure 19: Electrical structure of the high current rectifier

The connections' geometry is not symmetrical since there is an unbalance on the equivalent impedance of each electrical branch (Fig. 20). The electrical equivalent circuit of cabling (obtained via the PEEC models implemented in InCa3D) has been introduced inside a circuit simulator and the waveform of current in the diodes is presented on Figure 21. A real unbalance is observed which obliges the designer to oversize the components.

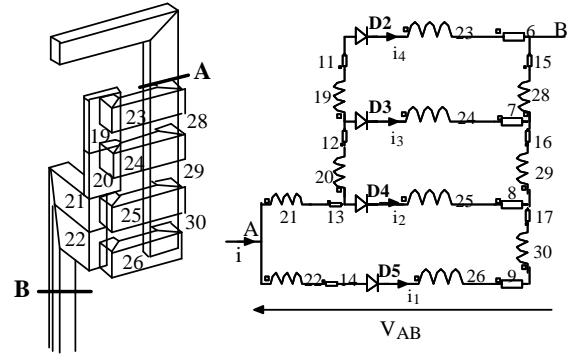

Figure 20: Geometry and electrical equivalent circuit of one phase of the rectifier

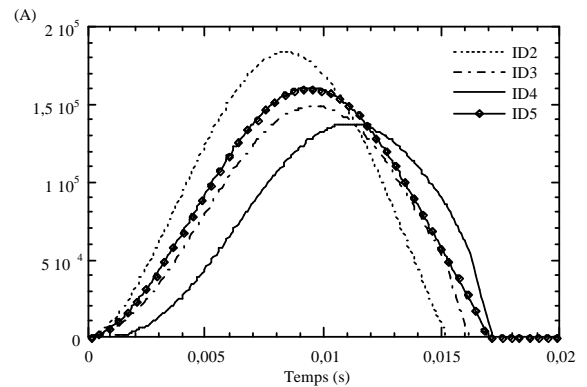

Figure 21: Current inside the four diodes

### 3.6 System-level simulation

All the many examples presented till now in this paper are characterized by the use of one or some tools which work sequentially, in the sense that the results computed by one of them are exported and exploited by another software. Such a strategy is very efficient in most of cases, but another scheme (named co-simulation) also exists and can be better-tailored when multiphysic problems have to be addressed. In the co-simulation principle the involved tools exchange data and results at each computation step, allowing a more accurate simulation.

In order to illustrate the possibilities offered by the Flux-Portunus co-simulation an example dealing with a hybrid car is provided in this part [14]. The model presented only involves the electrical motor coupled



with the mechanical load (the car) and the motor drive which is based on direct torque control. A simple regulation loop gives the torque reference value in order to regulate the car's speed.

Figure 22 shows the principle. Finite element method using Flux gives finite element model of the electrical machine. In the bottom right corner is the mechanical load: electromagnetic torque computed from Flux is linked with a torque source. This torque source is part of the mechanical equivalent schematic involving a gearbox wheel model and a mass in translation that corresponds to the car.

The bottom left corner represents the speed regulation loop and a very simple battery model.

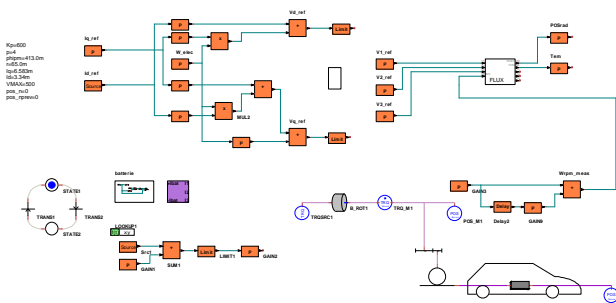

Figure 22: Electrical mode of a hybrid vehicle in Portunus with finite element modelling of the electrical motor

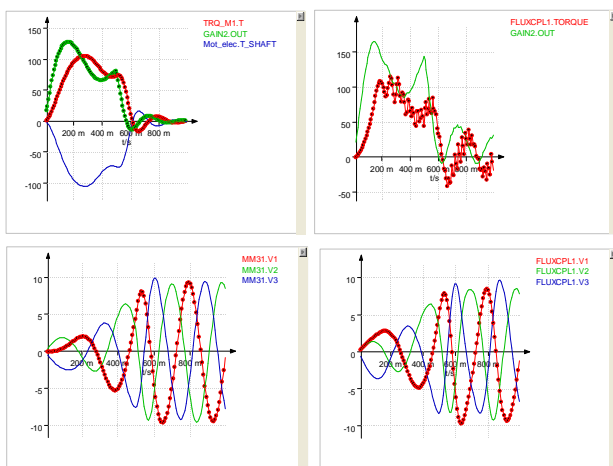

Figure 23: on left part are shown the results obtained from the analytical model (torque and torque reference value on top, and voltages at bottom). On right part the same results obtained with finite element cosimulation

The simulation was run on a small time sample in which the car starts accelerating and reaches a constant speed value. The results are compared to those obtained with the same system but replacing the finite element model of the machine by an analytical model. Results in terms of torque (top) and

voltage (bottom) waves are presented in the Figure 23.

### 3.7 Optimisation of structures

Along the previous examples, we have seen that the impact of cabling upon the performances of a whole structure can be evaluated. Additional losses, non desired magnetic field or couplings have been underlined. So it is obvious to want to improve the structure performances and more particularly the cabling effectiveness inside the studied device.

According to the desired data, conditions and degrees of freedom, a quasi Newton method or genetic algorithms can be applied.

Different experiments have been undertaken in that field.

A CFSQP algorithm has been used to reduce the additional losses due to cabling by modifying the current distribution inside the cross section of conductors. This way, the example of Figure 2 has been optimized. Results presented on Figure 24 show that it is possible to reduce the total losses by nearly 20% [15] by only changing the positions of bars. In that case, proximity effect is under consideration and is modified that way (Fig. 25).

The benefit can be very important since we consider the parameters of table V assuming that kilometres of distribution bars are installed every year.

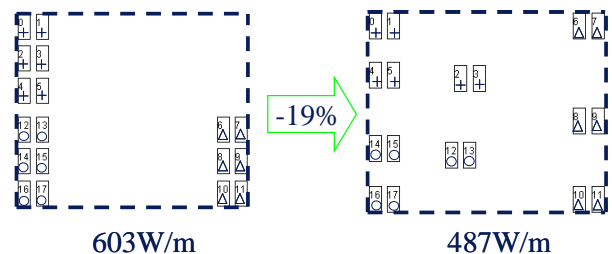

Figure 24: Result of an optimization process on position of distribution bars

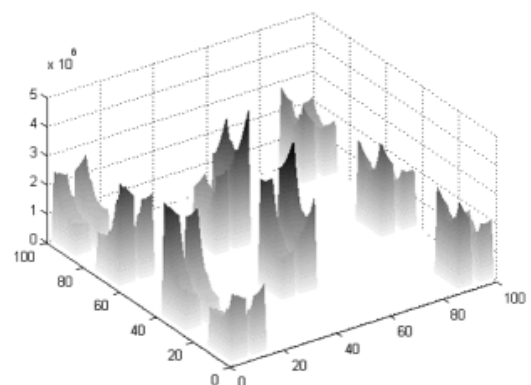

Figure 25: Result of an optimization process on current distribution

Table V: Performances of the optimization process

PEEC calls:	972
Time (PIII 450MHz):	1,508 s
Savings (1\$/W/year):	3.5k\$/m/30years

For another example of distribution bars (Fig. 26), genetic algorithm has been used to modify the shape of the cross section of each bar in order to better use the copper. In that case, skin effect is under consideration and will be reduced [16].

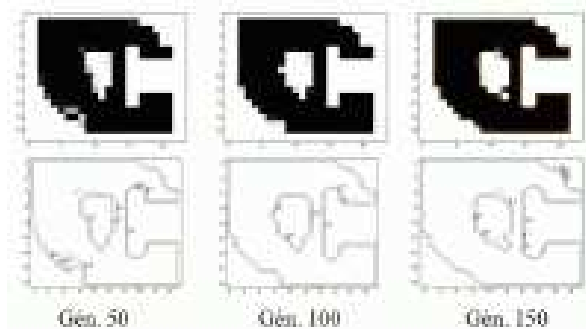

Figure 26: Result of an optimization process

### 3.8 Conclusions

In this section several modelling applications have been presented. Depending on the studied structure (geometry and physic), the appropriated modelling method is chosen and applied using customised simulation tool. Some couplings between simulation tools have been presented. Some of them are very simple since they only consist in a data transfer. Others are more complicated since they have led to a development of new formulations and new applications.

### 4. Towards a simulation environment

The previous section has listed a lot of studies that can be achieved using the modelling methods presented in section II.

The evaluated data are a real help to the designer in order to make the design process more competitive. This part is dedicated to the establishment of a simulation environment, a real electromagnetic modelling platform which allows designing power structures by reducing the time and costs process. The principal aim is to make possible to exchange information between the different simulation tools which have been previously presented.

But a simple dialogue via models is not sufficient and sometimes it becomes necessary to strongly couple the modelling methods in order to benefit from the advantages of each of them as we have seen before.

The coupling between PEEC and FEM methods has

been achieved for power electronic application [10]. In the same time, a coupling between FEM and Portunus has been proposed [14] in order to improve the design process.

A coupling between Portunus and InCa3D is also available. The equivalent circuit evaluated thanks to InCa3D is directly exported towards Portunus in order to undertake time simulation by associating models of power semiconductor components and their control part.

So the final simulation platform should be the one presented on the Figure 27.

The centre of it could be the three simulations tools, Flux for the FE Method, InCa3D for PEEC method and Portunus for the simulation system. Obviously, a constant dialogue and data transfer must be possible between them and also with other simulation tools.

The evaluated data are multiple: local such as current density or magnetic field, global such as total losses but also electrical, magnetic, mechanical or even thermal quantities.

Some links are already achieved, others have to be developed or thought up.

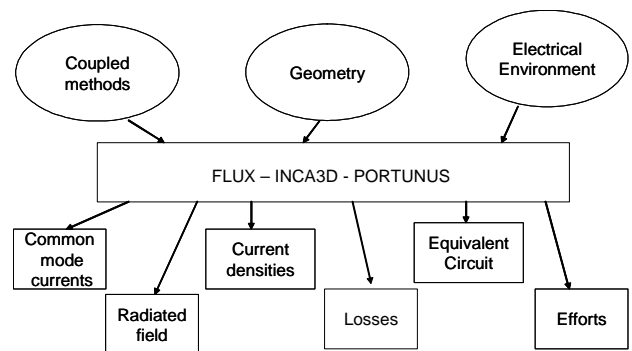

Figure 27: Simulation platform to design power electronics structures

### 5. Conclusions

This article has presented a methodology which can lead to a simulation platform allowing simultaneous modelling of a complete system such as a vehicle including power converters and cables. Thanks to appropriated couplings of methods and models the advantages of three simulation tools, Flux, InCa3D and Portunus have been reinforced.

### 6. References

- [1] David G. Dorrell, "Design Requirements for Brushless Permanent Magnet Generators for Use in Small Renewable Energy Systems", IECON2007
- [2] J-P. GONNET, E. CLAVEL, V. MAZURIC, J. ROUDET, "PEEC Method dedicated to the design of electrical systems", PIERS04, Pise, Italie, 28-31 Mars 2004

- [3] <http://www.cedrat.com>
- [4] V. ARDON, J. AIME, O. CHADEBEC, E. CLAVEL, E. VIALARDI, "MoM and PEEC Method to Reach a Complete Equivalent Circuit of a Static Converter", EMC Zurich 12-16 Jan. 2009, Zurich, Switzerland
- [5] R. Prades, M. Lionet, X. Brunotte, Y. Le Floch, E. Clavel, J.L. Schanen, J.M. Guichon, "Improving conducted EMI forecasting with accurate layout modeling", 2EMC07, 18 – 19 Oct 07, Rouen, France
- [6] J-M. GUICHON, E. CLAVEL, Y. MARECHAL, V. MAZAURIC, "Method to compute current density in power distribution bars", IEEE - CEFC'00, Milwaukee, Wisconsin, USA, 4-7 June 2000, pp 375
- [7] J.Aimé, J.Roudet, E.Clavel, M.Arpillière, O.Aouine, C.Labarre, F.Costa, J.Ecrabey, "Prediction and measurement of the magnetic near field of a static converter", ISIE07, 04 June - 07 June 2007, Vigo, Espagne
- [8] J-P. GONNET, E. CLAVEL, V. MAZAURIC, J-M. GUICHON, J. ROUDET, "Method for an optimal design of interconnections busbars", IEEE-CEFC, Seoul, Korea, 6-9 Juin. 2004, pp 26
- [9] J. AIME, T. S. TRAN, E. CLAVEL, G. MEUNIER, Y. LEFLOCH, J. ECRABEY, "Magnetic field computation of a common mode filter using Finite Element, PEEC methods and their coupling", ISIE08, 30 June – 2 July 08, Cambridge, England
- [10] T-S. Tran, G. Meunier, P. Labie, Y. Le Floch, J. Roudet, J-M. Guichon, Y. Maréchal, "Coupling PEEC-Finite Element Method for Solving Electromagnetic Problem", Compumag proceedings June 24th – 28th 2007, Aachen, Germany
- [11] [www.simulia.com](http://www.simulia.com)
- [12] J. AIME, J. ROUDET, C. VOLLAIRE, P. BAUDESSON, J. ECRABEY, « Layout techniques for reduction of common mode current in static converters », IEEE IAS Annual Meeting Report, Oct. 2006, Vol. 5 p. 2296- 2303
- [13] E. CLAVEL, J-L. SCHANEN, J. ROUDET, A. FONTANET, "Influence of the Cabling Geometry on Paralleled Diodes in a High Power Rectifier", IEEE - IAS'96, San Diego CA, 6-10 Oct. 1996, pp 993 - 998
- [14] B. du Peloux, G. Lacombe, "Engineering-focused software for the design of the drive of electrical machines", ICEM 2008,
- [15] J-M. GUICHON, E. ATIENZA, E. CLAVEL, J. ROUDET, V. MAZAURIC, « Automatic design of busbar considering electrical criteria », IEEE – PES-TD, Atlanta, Georgie, USA, 29 Oct. – 2 Nov. 2001, 6 pages
- [16] J-P. GONNET, J-M. GUICHON, E. CLAVEL, J. ROUDET, V. MAZAURIC, « Improving the energetic efficiency of distribution busbars », IEEE – PES-TD, Dallas, Texas, USA, 7-12 Sept. 2003