



HAL
open science

Analyse du comportement radiatif de matériaux de l'infrastructure routière: Principes et mesures de l'émissivité infrarouge

Mario Marchetti, Laurent Ibos, Abderrahim Boudenne, Stefan Datcu, Yves Candau, Jean Dumoulin, Jean Livet

► To cite this version:

Mario Marchetti, Laurent Ibos, Abderrahim Boudenne, Stefan Datcu, Yves Candau, et al.. Analyse du comportement radiatif de matériaux de l'infrastructure routière: Principes et mesures de l'émissivité infrarouge. Bulletin des Laboratoires des Ponts et Chaussées, 2008, 272, pp 45-55. hal-00362947

HAL Id: hal-00362947

<https://hal.science/hal-00362947>

Submitted on 19 Feb 2009

HAL is a multi-disciplinary open access archive for the deposit and dissemination of scientific research documents, whether they are published or not. The documents may come from teaching and research institutions in France or abroad, or from public or private research centers.

L'archive ouverte pluridisciplinaire **HAL**, est destinée au dépôt et à la diffusion de documents scientifiques de niveau recherche, publiés ou non, émanant des établissements d'enseignement et de recherche français ou étrangers, des laboratoires publics ou privés.

Analysis of the radiative behavior of road materials: Principles and measurements of infrared emissivity

Mario MARCHETTI^{1*}, Laurent IBOS²,
Abdel BOUDENNE², Stefan DATCU²,
Yves CANDAU², Jean DUMOULIN³,
Jean LIVET¹

¹LRPC de Nancy, CETE de l'Est
Équipe de Recherche Associée au LCPC
n°31 Exploitation de la route en conditions
météorologiques dégradées
²CERTES, Université Paris XII Val-de-Marne,
Créteil, France
³LCPC-SMI-TI, Centre de Nantes, France

■ ABSTRACT

Infrared emissivity is a critical parameter for numerical models designed to predict surface temperature as well as road surface conditions, regardless of the meteorological context. This article will describe the development of a new device for indirect measurement of infrared surface emissivity. The surface is exposed to an isotropic, modulated infrared radiation. The intensity of radiation reflected by the surface in a given direction is then measured with a thermopile-type detector operating within the 1-40 μm spectral band. This wide spectral band yields the total directional emissivity measurement, defined as emissivity. The effects of temperature modulation frequency, surface composition and roughness have all been studied. Results reveal an adequate device capacity in determining infrared emissivities for the surface temperatures targeted by this analysis. The measurements conducted on some road infrastructure materials will also be presented.

Analyse du comportement radiatif de matériaux de l'infrastructure routière. Principes et mesures de l'émissivité infrarouge

■ RÉSUMÉ

L'émissivité infrarouge est un paramètre nécessaire pour les modèles numériques de prévision de la température ainsi que de l'état de surface quelle que soit la situation météorologique. Ce travail présente le développement d'un nouveau dispositif de mesure de l'émissivité infrarouge de surface par une méthode indirecte. La surface est soumise à un rayonnement infrarouge isotrope et modulé. L'intensité du rayonnement qu'elle réfléchit dans une direction donnée est mesurée à l'aide d'un détecteur de type thermopile. Celui-ci opère dans la bande spectrale 1-40 μm . Cette large bande spectrale conduit à la mesure de l'émissivité directionnelle totale, définie en tant qu'émissivité. Les effets de la fréquence de la modulation de température, de la composition de surface ainsi que de la rugosité ont été étudiés. Les résultats indiquent la bonne capacité du dispositif à déterminer des émissivités infrarouges à la température des surfaces analysées. Des mesures sur des matériaux de l'infrastructure routière sont également présentées.

* CORRESPONDING AUTHOR:

Mario MARCHETTI

mario.marchetti@developpement-durable.gouv.fr

INTRODUCTION

The road of the future is expected to provide us with information on its condition, regardless of the weather [1]. The TOTEM project (French acronym for driving under all weather conditions) within the *Road operational tools* research project seeks to identify and characterize the physical properties of the road that are capable of assisting in the determination of such climate-specific information. The first series of investigations have focused on onboard infrared vision under adverse road weather conditions.

Knowing road surface infrared emissivity is mandatory to understanding the meteorological and road phenomena that develop on pavement surfaces. Moreover, this knowledge proves critical to

modeling the heat exchanges taking place between pavement and atmosphere, in the aim of predicting both surface state and surface temperatures. Modeling progress has indeed revealed the importance of emissivity on surface temperature. An emissivity increase from 0.92 to 0.98 could induce a surface temperature change by approximately 1.3°C, which in turn could affect winter maintenance [2], according to output from the CESAR/GELS model. This knowledge also becomes important when applying infrared thermography techniques since emissivity allows converting a luminance temperature measurement to a surface temperature. Developments until now have been based exclusively on data from the literature. The objective behind the work presented in this article consists of manufacturing a system capable of measuring the hemispherical emissivity of a material at ambient temperature. A brief bibliographic review will be provided. A first part will then describe the characteristics associated with such a measurement system, in addition to emissivity measurement conditions when using the indirect method. A second part will then concentrate on the influential factors of material emissivity as well as on measurements pertaining to road infrastructure materials.

BIBLIOGRAPHIC REVIEW OF EMISSIVITY DETERMINATION TECHNIQUES

By definition, the emissivity of a real body indicates the ratio between the emission of this body and that of the ideal body, called black body, brought to the same temperature.

Emissivity is said to be either monochromatic, if it corresponds to a single wavelength, or total if it encompasses the entire spectrum.

The term directional emissivity is employed when considering a given direction, while hemispherical emissivity refers to the case where all emission directions are considered within the half-space lying directly over the material surface [3].

Emissivity is measured by means of either a direct or indirect method [4,5]. When the chosen technique is indirect, the measurement conducted yields reflectivity, with emissivity then being deduced by introducing Kirchhoff's Law for the given measurement conditions:

- source emissivity does not depend on emitted wavelength, but instead remains constant over the entire spectrum;
- the source and material targeted by the emissivity measurement both exhibit the same temperature.

Under these conditions, it is possible to write: $\varepsilon = 1 - \rho^{\circ}$, with ρ° being the directional hemispherical reflectivity, corresponding to the total incident flux fraction stemming from all isotropic hemispherical directions that gets reflected in a given direction.

The direct method on the other hand relies on either a calorimetric technique [4-7] or a radiometric technique with a reference black body [8]. In order to mitigate the effects of radiation emitted by the ambient medium as well as *noise*, a modulation has been introduced using a mechanical system [9,10]; another approach calls for modulating the emitted signal [6,11,12].

The indirect method uses Kirchhoff's Law. Reflectivity is measured and the emissivity subsequently deduced, as explained above. A spectrometer may be used in order to access the directional monochromatic emissivity [4,10], or this can be accomplished with an integrating sphere [13]. Other commercial set-ups or prototypes are also available: all contain a detector (thermopile, bolometer, etc.) that collects the infrared flux reflected by the material at a given temperature [14-16]. Another technique developed involves a multispectral radiometer [17]. Several algorithms have been derived for extracting emissivity from measurements [18-20]; such radiometers, such as the one developed by the company CIMEL, have been employed to determine emissivity [21-24]. Use of an infrared camera has been described by Gaussorgues [25].

Emissivity determination may also be conducted with an infrared camera, as indicated by Madding [26,27]. In some cases, this could lead to deviations in emissivity value on the order of 0.2. Another infrared technique considered, in the aim of accessing pavement emissivity, makes use of frequency modulation [28] and therefore avoids variation due to emissivity variations. An equivalent technique has been applied by Holzwarth for measuring water thickness [29].

DESCRIPTION OF THE EMISSIVITY MEASUREMENT DEVICE AT THE RPC NANCY LABORATORY

■ Emissivity measurement principle

According to Kirchhoff's Law, the directional emissivity of an opaque body exposed to incident isotropic radiation can be written as follows:

$$\varepsilon(\theta) = 1 - \rho(\theta) \quad (1)$$

with $\varepsilon(\theta)$ and $\rho(\theta)$ being the emissivity and directional reflectivity, respectively. Reflectivity depends on the spectral range of incident radiation. The radiation source must therefore lie at a temperature near that of the body under analysis.

The experimental set-up developed jointly with the CERTES performs measurements at ambient temperature by means of the indirect method; it measures the infrared radiation reflected by the surface of the target object, exposed to a modulated and controlled heat flux [6,7]. Given its broad spectrum, this set-up enables measuring total directional emissivity, which will simply be called emissivity in this article.

■ Description of the emissivity measurement device

The emissometer is composed of four main components (as presented in [Figure 1](#)):

- the infrared source (hemispherical and isotropic), consisting of a metal cube made from an aluminum alloy. Its temperature is controlled by Peltier elements juxtaposed on its outer surface. The source temperature is measured by a K-type thermocouple inserted into the upper face of the cube, with the signal conditioned by an Analog Device 5B37 module. Its inner surface is covered with a highly-emissive Nextel Velvet 811-21 paint;
- a thermopile-type detector sensitive to infrared radiation, produced by Dexter Research™ (the 1M model), featuring an average voltage sensitivity of $s = 18.9 \text{ V} \cdot \text{W}^{-1}$. Its signal is thereby amplified using a Dexter™ 1010 low-noise amplifier and conditioned by an Analog Device™ 5B30 module;
- an optical measurement device for reflected flux, consisting of an iris diaphragm and a lens transparent to infrared radiation in KRS5, with both a diameter and focal length equal to 38 mm. KRS5 is transparent to infrared radiation over the range 0.5-40 μm and is itself composed of TlBr-TlI. The lens serves to focus the infrared flux reflected onto the detector. The infrared flux passes through a 10-mm diameter orifice on the upper face of the infrared source;
- a computer-driven data control and acquisition chain assisted by a program developed using the LabVIEW™ application.

The computer generates a sinusoidal signal conditioned by an Analog Device™ 5B49 module, which then gets amplified by introducing a power amplifier. This signal feeds the Peltier modules connected both in series and in parallel. The source temperature is thus modulated at a known frequency. The section of flux reflected by the sample is proportional to the reflectivity ρ of the same sample. Both the optical device (lens, diaphragm) and detector (thermopile) serve to measure the flux reflected in a specific direction; this configuration improves thermopile directivity, so as to derive a rather small solid measurement angle. This angle in turn facilitates a directional hemispherical reflectivity measurement, where the direction creates a 15° angle with respect to the normal.

Figure 1
Simplified diagram of the portable emissometer

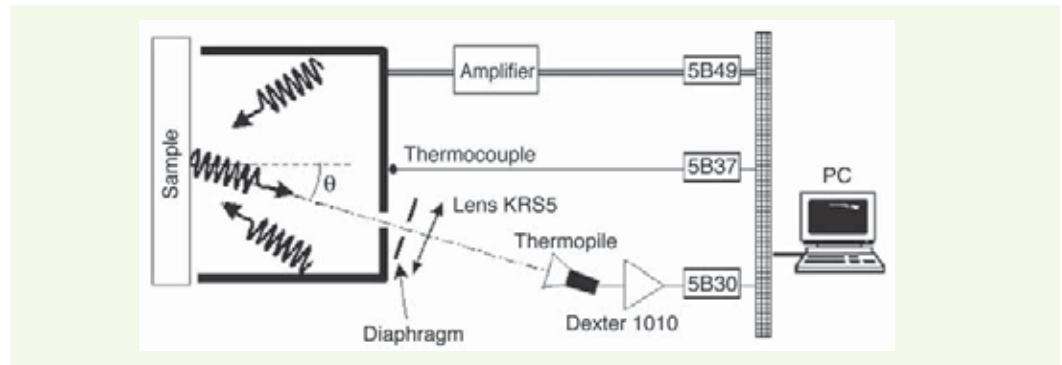

■ Infrared emissivity calculation

A calibration step is performed using a material with known emissivity ε_{ref} . Let \tilde{U}_{ref} and $\tilde{\Phi}_s$ denote respectively the thermopile voltage and flux received at modulation frequency. It can then be stated that:

$$\tilde{U}_{\text{ref}} = C \cdot (1 - \varepsilon_{\text{ref}}) \cdot \tilde{\Phi}_s = C \cdot (1 - \varepsilon_{\text{ref}}) \cdot \sigma \cdot \tilde{T}_s^4 \quad (2)$$

This development therefore provides both the source temperature $T_s(t)$ and a voltage $U(t)$ proportional to the flux received by the thermopile. C is a constant that incorporates the reference body emissivity as well as the thermopile sensitivity, amplification factor, shape factor and transmission coefficient. σ represents the Stefan-Boltzmann constant.

The measurement process can then be conducted on the desired material of unknown emissivity under the same experimental conditions, and this step yields:

$$\rho = K \cdot \frac{\tilde{U}_m}{\tilde{T}_s^4} \quad (3)$$

The temporal signals $T_s(t)$ and $U(t)$ are filtered in order to eliminate high-frequency noise, and the phase is then fixed to obtain a whole number of periods. By crossing the frequency domain using a Fourier transform, both the signal amplitude \tilde{U}_m and temperature to the fourth power \tilde{T}_s^4 at modulation frequency are extracted.

\tilde{T}_s^4 lies on the order of $8 \cdot 10^9 \text{ K}^4$ in the vicinity of 300 K. At this point, taking the Fourier transform of \tilde{T}_s^4 could introduce an instability into the numerical computing. The amplitude \tilde{T}_s^4 is thus written as follows:

$$\tilde{T}_s^4 = T_{\text{max}}^4 - T_{\text{min}}^4 = \left(T_{\text{moy}} + \frac{\Delta T}{2} \right)^4 - \left(T_{\text{moy}} - \frac{\Delta T}{2} \right)^4 \quad (4)$$

$$\tilde{T}_s^4 = 8 \cdot T_{\text{moy}} \cdot \frac{\Delta T}{2} \cdot \left(T_{\text{moy}}^2 + \left(\frac{\Delta T}{2} \right)^2 \right) \quad (5)$$

T_{moy} and ΔT are the average temperature and temperature deviation, respectively, during the measurement procedure for the selected frequency.

Based on the magnitudes derived in this manner, the directional hemispherical reflectivity is calculated and serves to access infrared emissivity thanks to Kirchhoff's Law:

$$\varepsilon = 1 - K \cdot \frac{\tilde{U}_m}{\tilde{T}_s^4} \quad (6)$$

where K is a proportionality coefficient obtained by calibration, in using a sample of known emissivity as the control material.

RESULTS OF EMISSIVITY MEASUREMENTS CONDUCTED ON ROAD INFRASTRUCTURE MATERIALS

■ Influence of temperature modulation frequency

The influence of temperature modulation frequency has been evaluated with a $15 \times 15 \text{ cm}^2$ alumina plate. Four modulation frequencies were considered for this step, with five emissivity measurements carried out at each frequency. Both the thermal amplitude and average emissivity resulting from this measurement campaign are listed in the table below. For each measurement, a calibration was undertaken using a sheet of aluminum foil whose emissivity was set at $\epsilon_{\text{ref}} = 0.063$. The reflecting face of this material displays a hammered appearance that lends a visible roughness. A verification step was also performed with a black Nextel Velvet coating of constant emissivity within the considered spectral and temperature ranges [30]. These steps were conducted at the tested frequencies, and the maximum voltages applied were held constant during this procedure; results are provided in Table 1.

Table 1
Impact of modulation frequency on an emissivity measurement

Frequency (mHz)	Period (s)	Amplitude of the temperature modulation (K)	Emissivity	Standard deviation
25,0	40	2,0	0,70	0,04
12,5	80	3,5	0,68	0,01
8,33	120	5,2	0,71	0,02
5,0	200	7,6	0,73	0,02

The measured emissivities remain more or less constant for the range of frequencies tested. The level of uncertainty however is smaller at lower frequencies: the thermal amplitude actually rises as frequency decreases. Moreover, it becomes necessary to incorporate the thermal inertia of the infrared source. An excessive frequency, i.e. an overly short period would lead to an insufficient dissipation of the infrared source during temperature modulation heating cycles. The risk of overheating the entire set-up would then increase, and the hypothesis that the temperature remains constant and equal between source and sample would no longer be respected. Even though low frequencies improve precision, they still extend measurement time, which could invalidate the whole procedure. A compromise thus proves essential and has focused on a frequency of 12.5 mHz.

■ Experimental emissivity measurement protocol

The temperature modulation frequency of the source has been set at 12.5 mHz (80-second period) and the control voltage amplitude of the power amplifier at 3 V. Measurements were carried out by including 10 full modulation signal periods. Each measurement therefore lasted 800 s, or 13 min and 20 s.

The emissivity measurement of a material may be summarized as follows:

- preheating of the device over the same number of periods as for an actual measurement;
- calibration using the aluminum material ($\epsilon_{\text{ref}} = 0.063$) [31];
- measurement validation by means of a 99.7% pure solid alumina;
- five consecutive emissivity measurements on the target material.

The preheating step ensures a thermally-balanced device and serves to avoid temperature drifts. The emissivity values listed are averages, as are their corresponding standard deviations.



› Effect of surface composition

Road infrastructure materials, e.g. surfacing materials, which are mixes of aggregates, bituminous binder, sand and mastic from various sources, are extremely heterogeneous. These compositions can obviously cause emissivity variations, which is also a highly critical consideration due to surfacing wear by traffic. Wear engenders the appearance of aggregates, erosion of the microroughness characteristic and a *caulking* of the macroroughness. From a schematic standpoint, a new road is at first entirely covered with bitumen, and this bitumen gets gradually removed by tire wear, hence raising the level of aggregate appearance; it is then altered by exposure to ultraviolet rays. The material emissivity value is thus a function of both bitumen and aggregates; moreover, the type of substratum also affects measurement results [32]. Nonetheless, surfacing wear modifies material roughness and surface composition simultaneously. A smoother surface exhibits lower emissivity than a rougher one, all other parameters being the same.

In order to assess the impact of a material composition change on its emissivity, a series of measurements has been undertaken. A sheet of household aluminum foil, which is only very slightly emissive, was covered by highly-emissive black adhesive strips. Three configurations (parallel strips, and grid pattern, then an adhesive ribbon by itself) were chosen. By proceeding with a binarization of images from the studied surfaces, an estimation of surface area fractions occupied by the aluminum φ_{Al} and by the adhesive ribbon $\varphi_{adhesive}$ could be identified. Emissivity was measured in each case and then compared with the result from a surface covered entirely by adhesive ribbon (see Table 2).

Emissivity variation is defined by the equation: $(\epsilon_{adhesive} - \epsilon_{Al+adhesive}) / \epsilon_{adhesive}$. It clearly appears that the set-up is capable of measuring low emissivity levels. A major composition change induces sizable emissivity variation. Let's assume that surface emissivity may be expressed as follows: $\epsilon = \varphi_{adhesive} \cdot \epsilon_{adhesive} + \varphi_{Al} \cdot \epsilon_{Al}$, with 0.01 emissivity for aluminum and 0.95 for the adhesive ribbon. It can then be stated that based on measurement values, the level of agreement is quite good between calculated and measured emissivities. Road surfacing wear exerts two primary impacts: aggregates become apparent and contribute directly to the radiative level, and roughness diminishes (as a result of *caulking* asperities). For the first impact, it is apparent that emissivity variation will be strong if the difference in emissivity between bitumen and aggregates (represented in this case by aluminum components) is high.

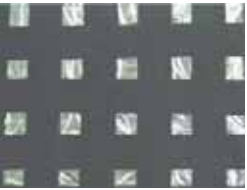
Table 2
Effect of composition variation on emissivity value



Composition	$\varphi_{adhesive}(\%)$	$\varphi_{Al}(\%)$	Calculated emissivity	Measured emissivity	Standard deviation	Emissivity variation (%)
Sheet of aluminum foil with parallel strips 	44	56	0.42	0.37	0.01	61
Sheet of aluminum foil with a grid pattern 	81	19	0.76	0.76	0.01	19
Black adhesive ribbon 	-	-	-	0.95	0.01	0

› Impact of roughness on emissivity measurements

The roughness of pavement surfacing material serves, among other things, to maintain a high level of skid resistance for vehicles. As roughness increases however, surfacing may further cool, as illustrated in the case of porous surfacing. Moreover, as indicated in the literature [25,33], the emissivity of a material may be significantly affected by its roughness.

The effect of roughness has been studied on various road surfacing structures. An aluminum paint (Rust Oleum no. 2115, from the RPM Company) was sprayed onto a smooth PVC surface and two road surfacing layers of different structure and macroroughness. Results are shown in Table 3.

Table 3
Effect of roughness on emissivity value

	Roughness	Emissivity	Standard deviation	Emissivity variation (%)
Aluminum paint on a smooth surface		0.34	0.01	0
Aluminum paint on a slightly rough surfacing		0.42	0.01	22
Aluminum paint on a very rough surfacing		0.69	0.02	101

Emissivity variation is defined by the expression $(\epsilon_{\text{rough}} - \epsilon_{\text{smooth}}) / \epsilon_{\text{smooth}}$, and roughness can be assimilated with a succession of *peaks* and *valleys*. In some instances relative to road surfacing, the valleys are actually deeper than they are wide and can then be assimilated with pseudo-black bodies inserted into the surface structure, thereby raising the emissivity value. Furthermore, due to this roughness and depending on the observation direction, some surface parts are concealed when applying an approach based on geometric optics, as noted by Sayapina *et al.* [33]. In the case of opaque and relatively unreflective materials, a portion of the infrared flux that would have been reflected by the same material with a smooth surface is then no longer accessible: the reflection coefficient ρ is decreasing. Within the framework of the hypothesis underpinning Kirchhoff's Law ($\epsilon = 1 - \rho$), emissivity will thus increase.

Sayapina *et al.* [33] suggested a profile for describing a rough surface; their configuration entailed a juxtaposition of small, flat microscopic elements, each of which forms a given angle with the observation direction. The flux received by the thermopile stems from both the direct emission by this body and reflection by each of the microscopic elements. The total directional emissivity can therefore be written as follows: $\epsilon = \epsilon_{\text{reflection}} + \epsilon_{\text{emission}}$

Sayapina *et al.* [33] established an emissivity expression for a rough surface in a setting described by geometric optics and by considering just a single reflection. Their research had focused on metals; based on this description, the emissivity due to emission can be written as:



$$\epsilon_{\text{emission}}(\theta) = \frac{1}{\cos(\theta)} \cdot \int_{\frac{\pi}{2} + \theta}^{\frac{\pi}{2} - \theta} \epsilon(\delta - \theta) \cdot \frac{\cos(\delta - \theta) \cdot f(\delta)}{\cos(\delta)} d\delta \quad (7)$$

In the present situation, the observation angle θ is equal to 15° with respect to the normal to the studied surface. $f(\delta)$ is the distribution of small surface element slopes with respect to the normal to the surface. It is assumed to be Gaussian and of the following form:

$$f(\delta) = \exp(-q \cdot \tan^2(\delta)) \quad (8)$$

As the value of roughness parameter q rises, the distribution becomes narrower and the surface smoother. The portion of emissivity due to reflection by roughness $\varepsilon_{\text{reflection}}$ depends on the observation direction. In this particular case, the angle is less than $\pi/6$. Based on the research cited [33] and in relying on the data and analysis set forth in test method no. 50 (Appendix M1.2) (internal LCPC document), the roughness of some surfacing materials is given in Table 4,

Table 4
Roughness values for a sample of surfacing materials

Type of pavement	Roughness (mm)	Parameter q
Semi-coarse asphalt concrete 	$0.25 < Ra < 0.73$	2
Thin, very thin and ultra thin asphalt concrete 	$0.26 < Ra < 1.95$	0.5

and the evolution of emissivity vs. roughness can be determined for $\theta = 15^\circ$. This evolution is depicted in Figure 2, with two situations considered: smooth aluminum paint (emissivity = 0.34), and a road sample (emissivity = 0.93). Sayapina's model leads to an increase in emissivity with roughness (i.e. as q decreases). For q values exceeding 10, roughness no longer affects emissivity.

The first case examines smooth aluminum paint, whose measurements were presented above for application onto a PVC support. For $q = 0.22$, which illustrates a fairly smooth pavement covered by aluminum paint, the numerical value derived lies close to the experimental value of 0.42. However, the measured emissivity value of 0.69, which corresponds to a very rough pavement, could not be numerically reproduced. The limitations of Sayapina's model, with just a single reflection, have undoubtedly been reached. Multiple infrared flux reflections must be taken into account, and this is particularly true for low emissivity surfaces, such as aluminum paint. In addition, the materials

Figure 2
Emissivity variation (as calculated using Sayapina's model) for a $\theta = 15^\circ$ observation direction vs. roughness parameter q

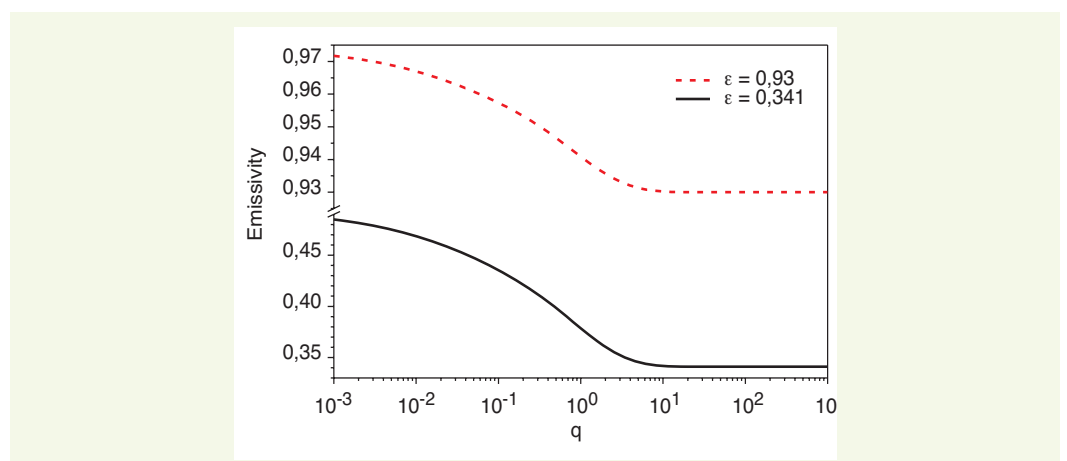

contain infrared absorption strips, a characteristic that can also affect measured emissivity vs. calculated emissivity, whereby this phenomenon has not been incorporated.

For the smooth surface with an emissivity value of 0.93, i.e. representative of measurements performed on road surfacing materials, application of Sayapina's model leads to variations ranging between 0.93 and 0.97, depending on roughness: for $q = 2$, $\varepsilon = 0.94$ and for $q = 0.5$, $\varepsilon = 0.95$. Such a difference might be related to the comment forwarded in the introduction, i.e. emissivity variation leads to temperature variation during a modeling exercise.

The drop in surface roughness coupled with abrasion of the surface bitumen layer in certain zones, which serves as an indication of wear, will cause a decrease in pavement emissivity.

› Case of road infrastructure materials

Emissivity measurements were conducted using various materials found in road infrastructure, yet no claim of exhaustiveness can be made at this point. The following materials were selected for this purpose: semi-coarse asphalt concrete exposed to light traffic, semi-coarse asphalt concrete exposed to heavy traffic, hydraulic concrete, temporary traffic signal panels, steel guardrails, horizontal road markings (applied onto a PVC support). The measurements were executed according to the experimental protocol described above, and results have been collated in [Table 5](#).

Table 5
Emissivities
at ambient temperature
within the 1-20 μm
spectral bandwidth

Material	Emissivity	Standard deviation
Semi-coarse asphalt concrete exposed to light traffic	0.93	0.02
Semi-coarse asphalt concrete exposed to heavy traffic	0.93	0.01
Hydraulic concrete	0.97	0.01
Temporary traffic signal panels	0.96	< 0.01
Galvanized steel guardrail	0.27	0.01
Horizontal road markings (white paint)	0.96	< 0.01

It can be concluded that emissivities remain near 1 within the selected spectral bandwidth, except for the steel guardrail. As is the case for many metals, its emissivity is weak.

CONCLUSION

A device has been developed for measuring total directional emissivity (1-20 μm spectral band) for materials at ambient temperature. It has demonstrated good aptitude in determining this physical parameter for use in heat exchange models designed to predict surface temperatures. The frequency of temperature modulation and total measurement duration may be chosen to ensure compatibility with onsite measurements. Respecting the temperature equality between infrared source and studied material must also be ensured. Measurement repeatability was found to be adequate. Emissivity measurements were undertaken for a wide array of values, a number of different surface compositions and various levels of roughness. The whole set-up can be transported on a given measurement site, provided the ambient conditions remain sufficiently stable.

The determination of material emissivity does not depend on modulation frequency. The choice of this frequency exerts an impact on measurement duration: the higher the frequency, the shorter the measurement period. Yet, the thermal inertia of the infrared source must be taken into account. As frequency rises, the infrared source has less time to dissipate the heating phase energy. An overly low frequency might also affect the thermal equilibrium of the infrared source for inertia reasons, thereby degrading measurement precision. This sequence could induce a change in system temperature, shifting it away from the ambient range. A frequency of 12.5 mHz offers a good compromise, without making measurement duration prohibitively long. The application developed with LabVIEW™ includes an emissivity calculation module during the measurement at the end of each

modulation period. Once the emissivity value has stabilized (e.g. a variation of less than 0.01), the measurement procedure may be considered complete. This set-up could serve for field measurements as well; however, measurement duration must be such that the ambient thermal variations stay within stability limits.

The measurements conducted on road infrastructure materials have led to values of around 0.95 (except for steel guardrails, with an emissivity of 0.27). Roughness and surface composition may be correlated with pavement surfacing wear, especially in the case of asphalt concretes. Measurements were taken on the same material applied to road surfacing with increasing roughness. Emissivity variation in the presence of roughness could reach 100% of that obtained for a smooth surface. Moreover, artificial composition heterogeneities induced variations of nearly 60%, compared with a homogeneous surface. A strong contrast in emissivity between materials proves necessary to generating significant variation. These measurements imply, for example, that the wear on a semi-coarse asphalt concrete could lead, depending on aggregate type, to a drop in emissivity (enhanced by a decrease in surfacing roughness). As mentioned in the introduction, an emissivity variation of 0.92 to 0.98 could produce a 1.3°C temperature deviation [2]. The emissivity of pure bitumen approaches 1 and corresponds to a new surfacing. The emissivity of an aggregate varies in the vicinity of 0.90, depending on its category. The aging of a surfacing material can thus engender a major modification in its radiative behavior and have implications regarding winter maintenance operations. In the case of a transverse pavement profile, relative to use of the various traffic lanes and hence the corresponding wear, the detection of an emissivity gradient could be expected. An emissivity distinction among the main surfacing families might also be envisaged, in particular across the various roughness and age categories.

The differences observed between a FLIR S65 infrared camera and the emissometer reveal that more in-depth understanding is indeed necessary. Precise measurements should be undertaken using an emissometer that allows working in the 7-14 μm spectral band with an adapted thermopile and, to the greatest extent possible, in multiple directions.

REFERENCES

- 1 **AUBERT D., BLOSSEVILLE J.-M. et al.** *La route automatisée. Réflexions sur un mode de transport du futur*, rapport LCPC, **1998**, 89 pages.
- 2 **BETTINELLI, J., LIVET J.** *Etude de la contribution des propriétés physiques des diverses structures de chaussées aux difficultés d'exploitation hivernale*, rapport LCPC, **2001**, 31 pages.
- 3 **HOLMAN J. P.** *Heat Transfer 8th edn*, **1997**.
- 4 **KATEB T., Chevalier J.-L.** *OPTORA et les techniques de mesure de l'émissivité : l'émissomètre calorimétrique de référence*, Cahiers du CSTB, **1991**, livraison 323 (cahier 2524).
- 5 **HERVÉ P.** *Mesure de l'émissivité thermique*, Techniques de l'Ingénieur, chapitre Température de surface, **1989**.
- 6 **SIROUX M., TANG-KWOR E., ESPECEL D., MATTÉI S.** Emissivity measurement by sine wave thermal modulation: radiometric and calorimetric approaches, *High Temp.—High pressures*, vol **30**, **1998**, pp. 217–22.
- 7 **SIROUX M., TANG-KWOR E., MATTÉI S.** A periodic technique for emissivity measurements of insulating materials at moderate temperature, *Meas. Sci. Technol.*, vol **9**, **1998**, pp. 1956–62.
- 8 **FURUKAWA T., LUCHI T.** Experimental apparatus for radiometric emissivity measurements of metals *Rev. Sci. Instrum.* vol **71**, **2000**, pp. 2843–7.
- 9 **PANTINAKIS A., KORTSALIOUDANIS N.** A simple high-sensitivity radiometer in the infrared for measurements of the directional total emissivity of opaque materials at near-ambient temperatures, *Int. J. Thermophys.*, vol **22**, **2001**, pp. 1843–54.
- 10 **SABUGA W., Todtenhaupt R.** Effect of roughness on the emissivity of the precious metals silver, gold, palladium, platinum, rhodium, and iridium, *High Temp.—High Pressures*, vol **33**, **2001**, pp. 261–9.
- 11 **ESPECEL D., MATTÉI S.** Total emissivity measurements without use of an absolute reference, *Infrared Phys. Technol.* vol **37**, **1996**, pp. 777–84.
- 12 **MATTÉI S., ESPECEL D.** Periodic technique for low temperature radiative property, *ASME Heat Transfer division*, vol **1**, **1996**.
- 13 **PERRAD Y.** *Optora et les propriétés optiques des matériaux macroscopiquement hétérogènes : la mégasphère et le réflectomètre à grande ouverture*, Cahiers du CSTB, **1991**, n° 2523, 16 pages.
- 14 **Devices and Services company**, <http://www.devicesandservices.com/prod03.htm>
- 15 **PAUMIER J.-L., ARNAL M. et al.** *Paramètre radiatif. Projet de développement d'un appareil de mesure de l'émissivité des chaussées. Sujet 1 66 04 9*, **1999**, rapport LCPC.
- 16 **FRANCOU L., SADOU A., RAMEL D., TEJEDA J.-C., HERVÉ P.** *Mesure directe de l'émissivité à basse température : Méthodes et techniques optiques pour l'industrie* « Congrès de Belfort, 2003, pp 104–109.
- 17 **SHUNLIN LIANG.** Inversion of land surface temperature and emissivity simultaneously from multispectral thermal infrared imagery ». *IGARSS 2000. IEEE 2000 Proceedings Cat. No. 00CH37120*, **2000**, vol 7, pp 3133–5.
- 18 **BECKER F., ZHAO LIANG L.** Surface temperature and emissivity at various scales : definition, measurement and related problems *Remote Sens. Rev.*, vol **12**, **1995**, pp. 225–53.
- 19 **PAUMIER J.-L., ROUMEAU S. et al.** *Radiométrie infrarouge- Rappels et méthodes de caractérisation de l'émissivité*, **1997**, rapport LCPC, 31 pages.
- 20 **MALAPLATE A.** *Radiométrie IR : développement et validation de méthodes utilisant la bande 3–5 micromètre pour la détermination des paramètres de surface à haute résolution spatiale*, Thèse de doctorat de l'université ULP1, Strasbourg, **2001**, 155 pages.
- 21 **PIETRAS C., ABUHASSAN N., HAEFFELIN M., BROGNEZ G., LEGRAND M., BUIS J.-P.** Development of a high precision thermal infrared field radiometer « *Proc. 6th Int. Symp., Physical measurements and signatures in remote sensing*, Val d'Isère, France, **1998**.
- 22 **BOY C.** *Faisabilité de la détermination de l'émissivité IR et de l'état d'un revêtement de chaussée à l'aide d'un radiomètre multispectral*, **1999**, rapport LCPC, 38 pages.
- 23 **DAMIRI B., LEGRAND M., et al.** *Programme de recherche et d'expérimentation destiné à déterminer la température de surface de la chaussée, son émissivité et son état de surface par une technique radiométrique sans contact*, **2000**, rapport LCPC, 37 pages.
- 24 **ROYER A., CHAGNON F.** *Système de mesures embarquées sur un véhicule de patrouille de viabilité hivernale - Amélioration de la mesure de température de surface et évaluation de l'état des routes*, **2004**, rapport de recherche MTQ FCAR Research Program 00-SR-71260.
- 25 **GAUSSORGUES G.** *La thermographie infrarouge*, Techniques et Documentation, **1981**, 386 pages.
- 26 **MADDING R. P.** Emissivity measurement and temperature correction accuracy considerations, *Proc. SPIE 3700*, **1999**, pp. 393–401.
- 27 **MADDING R. P.** Temperature dependence of the graybody approximation to emissivity for some common materials, *Proc. SPIE 4170*, **2002**, pp. 37–43.
- 28 **WIGGENHAUSER H.** Active IR applications in civil engineering » *Infrared Phys. Technol.* vol **43**, **2002**, pp. 233–8.
- 29 **HOLZWARTH F., EICHORN U.** Non-contact sensors for road conditions, *Sensors Actuators A*, vol **37–38**, **1993**, pp. 121–7.
- 30 **MATTÉI S.** *La métrologie infrarouge en régime périodique et son application à la caractérisation thermophysique des matériaux*, Thèse de doctorat Université Paris XII-Val de Marne, France, **1999**.
- 31 **DATCU S., IBOS L., CANDAU Y., MATTÉI S.** Improvement of building wall surface temperature measurements by infrared thermography, *Infrared Phys. Technol.*, vol **46**, **2005**, pp. 451–67.
- 32 **WOLFE W. L.** *Handbook of Military Infrared Technology*, 1965, 906 pages.
- 33 **SAYAPINA V. I., SVET D. YA, POPOVA O R.** Influence of surface roughness on the emissivity of metals, *A. A. Bailov Institute of Metallurgy, Academy of Sciences of the USSR*, vol **10**, **1972**, pp. 528–535.

