



HAL
open science

A reconfigurable IR-UWB radio interface, with directional antennas and localization capability, for wireless sensor networks

Aubin Lecointre, Daniela Dragomirescu, Pascal Berthou, Robert Plana

► To cite this version:

Aubin Lecointre, Daniela Dragomirescu, Pascal Berthou, Robert Plana. A reconfigurable IR-UWB radio interface, with directional antennas and localization capability, for wireless sensor networks. 14th IEEE International Conference on Electronics, Circuits and Systems, Dec 2007, Marrakech, Morocco. p. 1055-1058. hal-00356850

HAL Id: hal-00356850

<https://hal.science/hal-00356850v1>

Submitted on 28 Jan 2009

HAL is a multi-disciplinary open access archive for the deposit and dissemination of scientific research documents, whether they are published or not. The documents may come from teaching and research institutions in France or abroad, or from public or private research centers.

L'archive ouverte pluridisciplinaire **HAL**, est destinée au dépôt et à la diffusion de documents scientifiques de niveau recherche, publiés ou non, émanant des établissements d'enseignement et de recherche français ou étrangers, des laboratoires publics ou privés.

A Reconfigurable IR-UWB Radio Interface, with Directional Antennas and Localization Capability, for Wireless Sensor Networks.

Aubin Lecointre
LAAS-CNRS
University of Toulouse
7, Av du Colonel
Roche
31077 Toulouse cedex
4, France
alecoint@lass.fr

Daniela Dragomirecu
LAAS-CNRS
University of Toulouse
7, Av du Colonel
Roche
31077 Toulouse cedex
4, France
daniela@laas.fr

Pascal Berthou
LAAS-CNRS
University of Toulouse
7, Av du Colonel
Roche
31077 Toulouse cedex
4, France
berthou@laas.fr

Robert Plana
LAAS-CNRS
University of Toulouse
7, Av. du Colonel
Roche
31077 Toulouse
cedex 4, France
plana@laas.fr

Abstract – This paper proposes an IR-UWB radio interface layer which is able to deal with WSN context. With this intention, we present a reconfigurable IR-UWB with directional antennas and localization capability at 60 GHz. We introduce the advantages of using the millimeter band, directional antennas, localization and the reconfigurability. We also propose some implementations on a FPGA receiver.

I. INTRODUCTION

This study will be lead in the WSN (Wireless Sensor Networks) context. Thus, the constraints such as: low power, low cost, small size, and simplicity should be kept in mind all along this paper. There are a lot of applications for this kind of network, such as: monitoring, military applications, house automation, civil safety applications, ambient intelligence, ubiquitous computing, etc ...

Our specificity is to want a unique interface whatever the considered applications. Indeed, taking into account the broad panel of WSN purposes, it seems difficult to find a current solution among the current WPAN (Wireless Personal Area Network) standard, such as ZigBee, Bluetooth, WiMedia ... Each one could be adequate for one or two applications, but none of them is able to respond to the whole requirements of each applications. Because of the disparity of data rate, end-to-end delay, low power consideration, localization need, QoS (Quality of Service) need ... exigencies among the WSN applications. For example some applications will require an important data rate (video monitoring network) while some others will need a very small data rate, such as (network of temperature sensor).

Our proposition, inspired from software-defined radio is to set up an absolute radio interface, which, thanks to its reconfigurability capability, will be able to optimize its properties for dealing with the WSN applications requirements while respecting the four WSN intrinsic constraints. Our reconfigurable interface should be able to evolve according the application needs.

In order to implement our reconfigurability view, we have to choose an adequate wireless technology, i.e. a technique which could be easily deal with this kind of reconfigurability. We will show that IR-UWB (Impulse Radio Ultra WideBand) [1] has these properties among a lot of very interesting advantages in the WSN context (Section

II). However, IR-UWB technique is not deprived of drawbacks, and we will expose in the Section III how by using the millimetre-wave band, we could improve the response of our radio interface to the WSN problematic. Section IV will prove the interest of localization in WSN context and how we have design a localization capability receiver according the ToA (Time of Arrival) algorithm. In the Section V, we will illustrate the advantage, for our PHY (PHYSical) layer, of directional antennas, especially regarding the localization, and the four intrinsic WSN constraints. Section VI exposes the reconfigurability implementation; we will introduce how our reconfigurability vision differs from the classical software radio concept.

II. IMPULSE RADIO ULTRA WIDEBAND

The aim of this part is to remind some properties and characteristic of the IR-UWB technique. We will demonstrate the presence of a trade-off between performances and respect of WSN constraints.

IR-UWB is a very promising technology for the WSN applications. Let us quote these advantages: 7,5 GHz of free spectrum which could permit to reach high data rate, extremely low transmission energy, extremely difficult to intercept, multi-path immunity, low cost (mostly digital architecture), “Moore’s Law Radio” (performances, size, data rate, cost follow Moore’s Law), simple CMOS transmitter at very low power [1] [2]. Among the various families within UWB, we focus on family IR-UWB, Impulse Radio UWB which is appropriate for our context of application: wireless sensor network.

IR-UWB modulations such as PPM (Pulse Position Modulation), OOK (On Off Keying), PSM (Pulse Shape Modulation), and PAM (Pulse Amplitude Modulation) allow transmitting information over the channel [1].

However, in order to have multi-users capability and confer a noise-like aspect to the IR-UWB signal spectrum, Time Hopping (TH) is also implementing. TH is like a dynamic TDMA [1]. TH reduces the probability of collision in comparison with classical narrow band technique [3]. Thanks to advantages and properties introduced here, we choose to set up TH-PPM, TH-OOK, and TH-BPAM. The figure 1 permits to compare them according the BER (Bit

Error Rate) versus E_b/N_0 (ratio of Energy per Bit (E_b) to the Spectral Noise Density (N_0))) criteria.

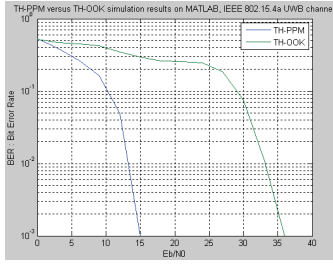

Figure 1. IR-UWB modulation according to BER/ E_b/N_0 in IEEE 802.15.4a UWB channel.

Figure 1 shows that TH-PPM (and TH-BPAM which offers approximately the same BER performance) is better than TH-BPAM and TH-OOK. Nevertheless BER versus SNR is not the only criteria decision. The chosen solution should be appropriate to the four WSN constraints: size, power, cost, and simplicity. Thus, let us study receiver architecture. Indeed, in IR-UWB, emitters are very simple. It consists in a UWB pulse generator and a baseband numeric command signal, which its goal is to activate the generator at the correct time.

The difficulty with IR-UWB is located in receiver. TH-PPM and TH-BPAM are correlation with template waveform based receivers. This coherent technique implies the need of synchronization filter. Consequently these receivers are more complex than non-coherent detection receiver such as TH-OOK [4]. Furthermore, by analyzing receiver architecture we could deduce that TH-BPAM and especially TH-PPM receiver is bigger than TH-OOK receiver. As a result we could say that there is a balance between BER performance and adequacy with WSN constraints. The better BER performances are, the less the receiver will respect WSN constraints. This trade-off is illustrated with the Table I, thanks to hardware implementations on ASIC and FPGA.

TABLE I. IR-UWB RECEIVERS CLASSIFICATION ACCORDING WSN CONSTRAINTS AND BER CRITERIA

Classification	WSN Constraints						
	Frequency	Size	Cost	Simplicity	Power	Data rate	BER
IR-UWB for WSN							
TH-PPM	100 MHz	83 kbytes	3	2	9.3 mW	12.5 Mbits/s	1
TH-BPAM	107 MHz	75 kbytes	2	2	8.57 mW	13.375 Mbits/s	2
TH-OOK	112 MHz	69 kbytes	1	1	8.32 mW	14 Mbits/s	3

Among the IR-UWB drawbacks, we could quote the limited emission power level and the use of a saturated frequency band. Because of the fact that IR-UWB band overlaps the 2,4 GHz and 5 GHz band. These latter are used by most of well-known communication protocols, such as Bluetooth, ZigBee, GSM, Wifi or WiMedia. In the following part, we will try to compensate this drawback thanks to millimetre-wave band.

III. THE MILLIMETER-WAVE BAND

We have seen the advantages and drawbacks of the IR-UWB technique. In this part we will try to improve this UWB solution thanks to the millimeter wave band (60GHz) [5]. The first advantage is that we are far from overbooked ISM and UNII band (respectively 2,4 and 5 GHz). As a result, the coexistence problem is less forcing. Interferences are lower. Thus the transmit power limitation is also less a constraint. Indeed, in the 3,1 – 10,6 GHz UWB band the power is limited because this band overlap the UNII and ISM band. At 60 GHz we have no more this problem.

According to the Friis formula, the attenuation due to the propagation over d meters is function of the wavelength (λ) and consequently the frequency of the signal (f):

$$L = \left(\frac{\lambda}{4\pi d} \right)^2 = \left(\frac{c}{4\pi d f} \right)^2$$

The higher the frequency is, the higher the absolute value of attenuation in dB is. In others words, the attenuation is more important at 60 GHz than at the classical UWB bandwidth. As a result the radio range will be of about few meters (WPAN). Nevertheless, this higher attenuation is also an advantage if we consider the spectral efficiency reuse. Indeed, since the radio range is low, the reutilisation distance of the 60GHz will be low also. 60 GHz band increases the network density by square meters. Consequently a large number of 60GHz network could be deployed in a small area, especially in a small indoor area. Walls or others important obstacles, knowing that we are at 60 GHz, will stop the propagation of the signal.

Finally, the last advantage of this millimetric wave band is the small wavelength ($\lambda=c/f$). Thus, emitters and receivers circuits will be smaller, in particular antennas. By working at this high frequency, we could compensate the propagation loss by using directional antennas (with higher gain than isotropic antennas) while maintaining low dimensions and therefore the respect of WSN intrinsic constraints. Our prospective PHY layer implies LOS (Line Of Sight) communications. It will have an impact on the MAC layer.

In order to evaluate the performance of our IR-UWB interface, we have to use a 60 GHz channel model. We use the IEEE 802.15.3c channel model [6]. This latter allows considering directional antenna at both end of communication link. We will see in the Section V, in details, what are the advantages of these antennas. Nevertheless, we could notice that they reduce the number of paths between the emitter and the receiver. Figure 2 illustrates the path loss and the shadowing effect in the IEEE 802.15.3c channel model.

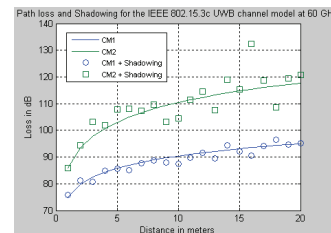

Figure 2. Illustration of the shadowing effect and the path loss for the IEEE 802.15.3c channel model at 60 GHz

IV. LOCALIZATION

IR-UWB has the capacity to determine the position of distinct nodes [7]. Indeed, it is enough to know the time of arrival (ToA) of the pulse for being able to determine the distance between the emitter and the receiver, since the propagation celerity of pulse is known ($v_{onde}=3.10^8$ m/s). Once, thanks to position estimation algorithm such as triangulation, each node is able to estimate the position of the others nodes. By using UWB, thanks to large bandwidth, we could obtain a better precision than with narrow band techniques.

We have implemented this simple version of ToA algorithm in an IR-UWB receiver on a FPGA. It is able to propose a distance estimation information (called 'd')

expressed in number of clock period. This value gives only the distance separating the emitter from the receiver. Consequently, the receiver is only able to place the emitter in a circle of radius d inside the radio range circle (Figure 3).

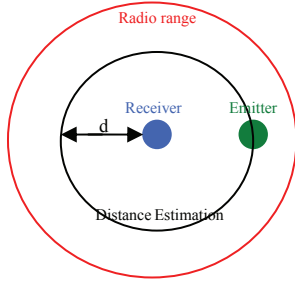

Figure 3. IR-UWB distance estimation technique with isotropic antennas.

In conclusion with this simple technique we could only make distance estimation position. In our FPGA receiver, we have implanted the ToA algorithm thanks to a matched filter (Figure 4). Its output is maximal when we are at the time arrival of the pulse [7]. Thus we have just to add a threshold comparator to detect this maximum, for determining the arrival time and consequently the distance. Since speed, distance and time of arrival are linked.

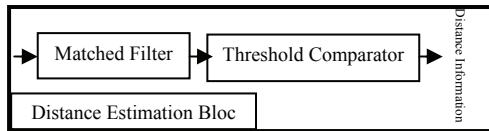

Figure 4. FPGA implementation of distance estimation mechanism

Let us note that in our ToA algorithm implementation, distance estimation precision depends of the clock period. The higher the clock rate is, the lower the error in meters is. Note also that, some WSN applications want to geo-localize each node reciprocally to optimize the network routing.

V. DIRECTIONAL ANTENNAS

The millimeter band allows us to use directional antennas because of the wavelength dependence of circuitry size. In our proposition we consider reconfigurable or steered beam antenna as the opposite of switched beam antenna. Thus for enabling communication between two nodes, their antennas must be aligned. It adds complexity at the MAC layer. It's a drawback because of the WSN context.

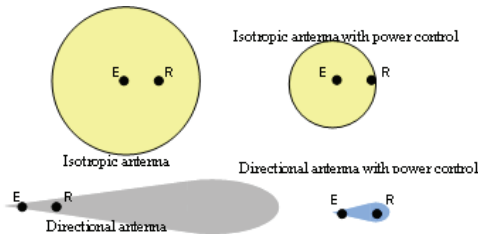

Figure 5. Illustration of the gain when using directional antenna with power control.

Directional antennas have a bigger gain than classical isotropic antennas, since the beam width is limited. Consequently, we could reduce the emission power in this architecture. It is important in our WSN context with low power constraint. Besides, use power control with directional antenna allows improving the low power capacity of our

solution. Indeed, as described in figure 5, the addition of this two mechanisms offer a better energy ratio between energy used for transmission and energy used for reaching the considered receiver [8].

Moreover, as the signal is now emitted in a cone, instead of a sphere, the ISI is reduced. Indeed, ISI depends of delay spread and this latter will be lower in this case since the delay between the different way through the directional antenna is lower. The lower ISI is, the lower interference there is. Thus, the number of retransmission decrease also and consequently the number of retransmission. Consequently, the energy for transmitting correctly information decreases also (WSN power constraint). Decreasing ISI implies also a diminution of the complexity, and a higher data rate capacity.

Furthermore, in comparison with isotropic antennas, in this case, we increase the network capacity [9], by permitting to have distinct transmission in a small area without collision. It would be not possible with isotropic area because the emitted signal is over a large area (Figure 6). Figure 6 illustrates perfectly that the two links "E1 → R1" and "E2 → R2", are only possible with directional antennas. Indeed, with isotropic antenna only the link "E1 → R1" will be possible without generates collision.

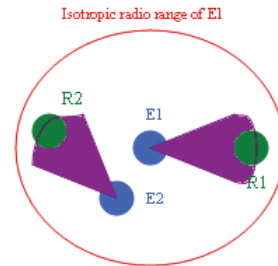

Figure 6. The increase of the network capacity thanks to directional antenna.

Finally, this kind of antenna facilitates the localization. As we have seen figure 3, our simple algorithm don't permit to obtain a correct estimation position. But coupled with directional antenna, we are able to substitute the estimation sphere by an estimation cone which depends of the beam width of the antenna. Directive antenna allows having very simple position estimation since if we receive a signal when the beam is oriented in a direction, inevitably the emitter is in this direction (Figure 7).

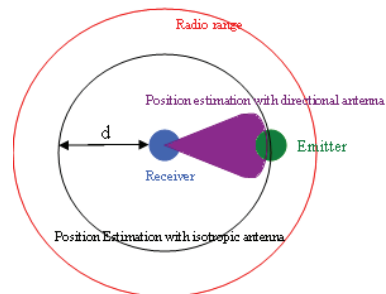

Figure 7. Position estimation technique with directional antenna.

The lower the beam width will be, the higher the estimation position will be.

VI. RECONFIGURABILITY

In this part, we will present the reconfigurable aspect of our system. We consider two type of properties receiver reconfigurability:

- Static properties receiver: absence of reconfigurability. Receiver characteristics values, (such as data rate, TH-code) ...are registered in hard in the VHDL code. Thus for adapting our reception system, we modify the code, and re-download it in the FPGA.
- Reconfigurable properties receiver: it is the most accomplished of our receiver according to the radio reconfigurability concept. Receiver characteristics values are modifiable without re-program the FPGA. This kind of reconfigurable receiver has many applications in self-organizing WSN where transceiver capabilities have to evolve.

Moreover, use this time domain technology: TH-IR-UWB involves adaptability capacities of the system. Modify the Time Hopping properties, (number of slot per frame (N_c), frame duration (T_f), time slot duration (T_c)), leads to data rate change. The data rate could be defined in function of T_f , T_c , and N_c . The data rate on the whole Time Hopping link (considering all the possible TH-code) is:

$$D_{total} (bits / s) = \frac{N_c}{T_f} = \frac{N_c}{N_c \times T_c} = \frac{1}{T_c}$$

Consequently, for changing the data rate, it is enough to change the slot duration (T_c). In IR-UWB mostly digital receiver, as we implement on a FPGA, it consists in changing a value in a register. Therefore, we can say that IR-UWB has very good properties for radio reconfigurability, thanks to its mostly digital architecture.

In our reconfigurable receiver, we have also implement TH-code reconfiguration. It consists of being able to change the TH-code reception and consequently the received channel. This reconfigurability is possible because TH-codes are representing in VHDL as integers. Consequently, it is possible to modify them, and so reconfigure the receiver.

In order to set up this reconfiguration concept, we have implanted the reconfigurable parameters as MAC layer outputs and PHY layer inputs (figure 8).

The MAC layer emulated by the computer thanks to Matlab, or Xilinx software, is in charge of: sending the configurable parameters to the FPGA; and start the reconfiguration by sending a specific signal, that we called "reconfiguration signal" in figure 8.

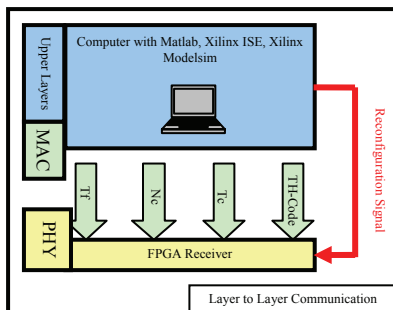

Figure 8. PHY and MAC Layer interface.

As MAC layer is an intelligent organ we could make the supposition that it sends the "reconfigurable signal" only after correctly place reconfigurable parameter at PHY layer entries.

Our radio reconfigurability design has some limitations due to its principle. Indeed, as we use VHDL entity entries

for reconfigurability, we undergo their limitations. In our example, we choose 8 bits to implement each reconfigurable parameter. It implies that we couldn't reach any kind of data rate in the reconfiguration (without re-programmed the FPGA). Nevertheless, this is true only if we don't take into account the RF limitations (due to RF circuits). In fact, it is this one, which will limit the data rate. Consequently, the VHDL entries limitations sizes (when FPGA is programmed) is not a limit but rather a dimensioning preoccupation. Since, once the FPGA is programmed we would be limited by the defined maximum value of your distinct entries. (with T_p : pulse duration, and k depends on the channel and modulation) :

$$T_c, T_p : std_logic_vector(N \text{ downto } 0);$$

$$T_c \in [k \times T_p; 2^N - 1]$$

$$D_{total} (bits / s) = \frac{1}{T_c} \Rightarrow D_{total} \in \approx \left[\frac{1}{2^N - 1}; \frac{1}{k \times T_p} \right]$$

This dimensioning is important because the number of bits allocated impact the size and consumption of the receiver, which are two important constraints in our WSN context.

The same report could be made with TH-code reconfiguration. We have implemented a data rate and TH-code reconfigurable IR-UWB receiver on a FPGA. It is able to change its data rate and its TH reception channel without requiring a FPGA re-programming.

VII. CONCLUSION

This paper introduces a reconfigurable IR-UWB at 60GHz radio interface with directional antennas, and localization capability. We have illustrated the IR-UWB capacities in the WSN context and how, by using directional antennas, the 60 GHz bandwidth and the localization, we could offer a better answer to the WSN problematic.

REFERENCES

- [1] I.Opperman, Jari Iinatti, Matti Hämäläinen, « UWB theory and applications », Wiley 2004.
- [2] D. Morche, C. Dehos, T. Hameau, D. Larchartre, M. Pelissier, D. Helal, L. Smaini, « Vue d'ensemble des architecture RF pour l'UWB », LETI, UWB Summer School , Valence, France, oct. 2006 à l'ESISAR.
- [3] MG. Di Benedetto, L. De Nardis, M. Junk, G. Giancola, « (UWB)²: Uncoordinated, Wireless, Baseborn Medium Access for UWB Communication Networks », *Mobile Networks and Applications*, vol. 10, no. 5, October 2005.
- [4] LM Aubert, Ph.D. dissertation: "Mise en place d'une couche physique pour les futurs systèmes de radiocommunications hauts débits UWB », INSA Rennes, France, 2005.
- [5] P.F.M. Smulders , "60 GHz radio : prospects and future directions", *Proceedings Symposium IEEE Benelux Chapter on Communications and Vehicular Technology*, 2003
- [6] Su-Khiong Yong, « IEEE 802.15.3c Channel Modeling Subcommittee Report », IEEE 802.15.3c sub-group modelling, March 2007.
- [7] S. Gezici, Z. Tian, G.B. Giannakis, H. Kobayashi, A.F. Molisch, H.V. Poor, Z. Sahinoglu, "Localization via ultra wideband radios", *IEEE Signal Processing Magazine*, July 2005.
- [8] Saad Alabeedi, "Antenna Beamforming for ad hoc networks", course of Carleton University.
- [9] A. Nasipuri, K. Li and U. R. Sappidi , "Power Consumption and Throughput in Mobile Ad Hoc Networks using Directional Antennas", *Computer Communications and Networks* , IEEE 2002.