



**HAL**  
open science

## **CMP Service: past, present, future**

Bernard Courtois

► **To cite this version:**

| Bernard Courtois. CMP Service: past, present, future. 2008. hal-00355627

**HAL Id: hal-00355627**

**<https://hal.science/hal-00355627>**

Preprint submitted on 23 Jan 2009

**HAL** is a multi-disciplinary open access archive for the deposit and dissemination of scientific research documents, whether they are published or not. The documents may come from teaching and research institutions in France or abroad, or from public or private research centers.

L'archive ouverte pluridisciplinaire **HAL**, est destinée au dépôt et à la diffusion de documents scientifiques de niveau recherche, publiés ou non, émanant des établissements d'enseignement et de recherche français ou étrangers, des laboratoires publics ou privés.

# CMP Service: past, present, future

Bernard COURTOIS

CMP

46 Avenue Felix Viallet

38031 Grenoble Cedex - France

Bernard.Courtois@imag.fr

**Abstract:** Infrastructures to provide access to custom integrated hardware manufacturing facilities are important because they allow Students and Researchers to access professional facilities at a reasonable cost, and they allow Companies to access small volume production, otherwise difficult to obtain directly from manufacturers. This paper is reviewing the most recent developments at CMP, as well as other services similar to CMP. These services helped the development of microelectronics for the EE&CS communities. Other communities might take advantage the same way, like the BioMed community. Examples of BioMed applications using CMOS and MEMS are given. The conclusion includes statements for the BioMed community as well as statements on where manufacturing infrastructures like CMP should go, considering technical developments towards More Moore, More than Moore, as well as statements related to globalization.

## I. THE NEED FOR INFRASTRUCTURES

In Microelectronics in general, infrastructures to provide access to custom integrated hardware manufacturing facilities are important for several reasons:

- they allow Students and Researchers to access professional facilities at a reasonable cost,
- they allow Companies to access small volume production, otherwise difficult to obtain directly from manufacturers.

The needs of Universities, Research Laboratories and Companies can be summarized as follows:

- Universities need to have access to technology for teaching their students. Those students will be in the industry. Therefore they have to be trained at least on the actual state of the art technology processes.
- Research Laboratories usually need to have high performance technologies to validate new concepts. The quality of the research results depends mostly on the quality of the technologies. Accessing to up to date technologies is a necessity.
- Industrial users also need to access to the state of the art of the offered technologies. This is vital for industrial users. The development of a product is usually long (more than 1 or 2 years). It is necessary that an industrial user has access to an up to date process, giving guaranty on product life.

Infrastructures are also important because of the leverage effect they allow. Infrastructures are a means to make it easier the development of many projects, while the funding of individual projects is less efficient (in terms of the number of projects). The major issue is to obtain an affordable cost. A large number of complex technological operations are required for integrated circuit fabrication, but circuits are cheap, due to the fact that most of those operations are repetitive. Each processed wafer of silicon is cut into hundreds of dice. For some of the slowest and costliest operations, "batches" of hundreds of wafers are

processed together. That means that tens of thousands of circuits are fabricated simultaneously. For non collective operations, such as test and packaging, operations are highly automated, using mass production techniques. These very expensive techniques, aimed primarily at mass production, seem out of reach for research and educational centers for integrated circuit design. However the design of a circuit by students must be pursued to its conclusions, which means fabrication, but a student will only require a few chips and mass production is not necessary. The basic idea of a multiproject chip is to collectively process circuits that are different and dissimilar. High fabrication costs can then be shared. To do so, a great number of elementary circuits are put side by side, to be reproduced on the wafer. The fabrication yield must be excellent, at least constant, since circuits cannot be tested before being sent back to the designer. This good yield is obtained through industrial production processes. This is pictured in Fig. 1. Prototypes or low volume production is cheap because of a shared wafer cost. This is known in general as Multi-Project Chip / Multi-Project Wafers techniques (MPC/MPW).

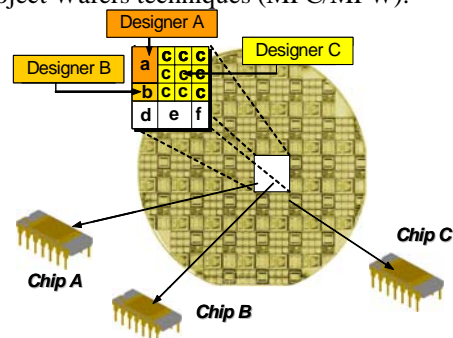

Fig. 1: MPC/MPW techniques

In addition to low cost, an affordable turn-around time should be available. This is pictured in Fig. 2: a total turn-around time of about 12 weeks can be obtained by services like CMP.

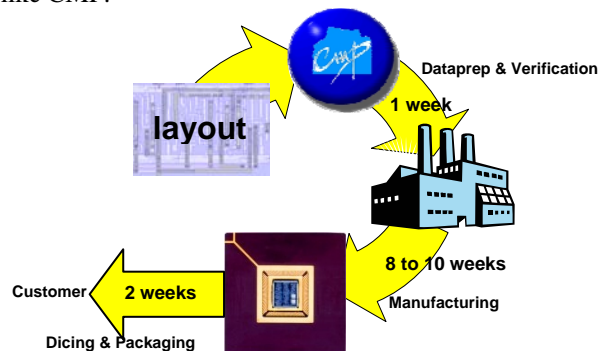

Fig. 2: From layout to packaged chips

Using such industrial processes, CMP could open the service to industry as early as 1990, for prototyping as well

as for low volume production. Low volume production is aimed at helping Small and Medium size Enterprises (SMEs) to get relatively small numbers of circuits (say a few hundreds or a few thousands), that they would not obtain directly from manufacturers. A center like CMP is then interfacing the IC manufacturers and the SMEs. Such an infrastructure allows the design of custom hardware from standard processes, i.e. no custom process development is required. To target an application only requires design capabilities.

## II. INTEGRATED CIRCUITS MANUFACTURING AT CMP

CMP is a non profit Service, reporting to CNRS (the French National Council for Research) and to Universities in Grenoble. A review of early efforts can be found in [1].

### Development at CMP

Several periods may be distinguished.

- 1981–1982 : launching CMP with NMOS
- 1983–1984 : development of NMOS, launching CMOS
- 1984–1986 : development of CMOS
- 1987–1989 : abandon NMOS, increase the frequency of CMOS runs
- 1990–1994 : launching Bipolar, BiCMOS, GaAs MESFET, GaAs HEMT, advanced CMOS (.5  $\mu$  TLM)
- 1995–1997 : launching CMOS and GaAs compatible MEMS, DOEs, deep-submicron CMOS (.25 $\mu$  6LM)
- 1998 : launching silicon surface micromachining, abandon MESFET GaAs
- 1999 : launching SiGe, deep submicron CMOS (.18 $\mu$  6LM), SOI/SOS CMOS (.5 $\mu$ )
- 2000 : launching SiGe BiCMOS (.35 $\mu$  5LM)
- 2001 : launching very deep submicron CMOS (.12 $\mu$  6LM)
- 2002 : launching Inp HBT process
- 2003 : launching 0.35 $\mu$  CMOS-Opto
- 2004 : launching very deep submicron CMOS (90nm, 7LM), HBT SiGe:C BiCMOS 0.25 $\mu$
- 2006 : launching CMOS 65nm (7LM)
- 2008 : launching CMOS 45nm

### Processes available

Presently the processes available for ICs manufacturing are depicted in Table 1.

Austriamicrosystems	0.35 $\mu$ CMOS C35B4C3
	0.35 $\mu$ CMOS C35B4M3
	0.35 $\mu$ CMOS-Opto C35B4O1
	0.35 $\mu$ CMOS Flash C35B4E3
	0.35 $\mu$ SiGe BiCMOS S35D4M5
	0.35 $\mu$ HV-CMOS H35B4D3
STMicroelectronics	45nm CMOS CMOS045
	65nm SOI
	65nm CMOS CMOS065
	90nm CMOS CMOS090
	130nm CMOS HCMOS9GP
	130nm SOI
	0.25 $\mu$ SiGe:C BiCMOS7RF
OMMIC	0.2 $\mu$ HEMT GaAs ED02AH

Table 1: IC processes available

### ICs design kits and CAD software

Design kits and libraries are distributed by CMP for most of the processes and most commonly used CAD tools. CMP sometimes develop design kits, in cooperation with the manufacturers and the CAD vendors. CMP also offers special CAD software conditions from a few CAD vendors. As a focal point, CMP also distributes information on configuration files, converters, etc. About 40 design kits are available for each process and the main CAD tools.

### Test and packaging

Packaging and testing services are also offered. Various types of packages are supported, including DIL, SOIC, CQFP, JLCC, PGA, etc. Test of prototypes is usually done by the final user. On request, especially for low volume production, CMP may take over testing together with manufacturing.

### Key figures

Since 1981, CMP has served more than 1000 Institutions from 66 countries in various processes. Support to Industry started in 1990. CMP has been ISO 9002-1994 certified from 2000 to 2003. CMP is working on the certification ISO 9002-2000.

### Recent developments

Recent developments have been the move to very deep submicron processes: 130nm CMOS, 90nm CMOS, 65nm CMOS and 65nm SOI, 45nm CMOS, .35 $\mu$  HBT SiGe BiCMOS, .25 $\mu$  SiGe:C HTB BiCMOS from STMicroelectronics and the exploration of new MEMS fabrication offerings.

### The move to very deep submicron processes.

CMP introduced 130nm CMOS as early as 2001. A total of 250 circuits were fabricated. CMP introduced 90nm CMOS in 2004 and 242 circuits have been fabricated up to now. 65nm CMOS was launched in 2006 and 57 circuits have been fabricated so far. This means a total of more than 500 circuits coming from about 50 Research Laboratories and Industrial Companies. These processes have been very well received. Let's detail what happened with the CMOS 90nm. The 90nm CMOS has been announced in 2004, first DRMs and design kits have been shipped to designers in 2004. The list of Institutions who have used the 90nm CMOS to date can be found in [17]. One can notice a number of top level Universities in Europe and North America mostly. All Canadian Universities are using the 90nm CMOS process. The move to 65nm has started. The 65nm CMOS has been announced in 2006. The list of Institutions who had circuits manufactured in 65nm can be found in [17]. Again there are many top level Universities in Europe and in North America who were moving to 65nm CMOS. A few circuits have been manufactured in 45nm so far.

## III. MEMS MANUFACTURING AT CMP

To address many real-life applications, integrated circuits are necessary, but additional features are also often necessary: basically mechanical features. All these features are usually provided by the so-called MEMS, Micro-ElectroMechanical Systems. There are 2 families of MEMS. First the bulk micromachining also called volume micromachining. In that case the substrate is etched in the depth, with a wet or a dry method, front side or back side.

These kinds of MEMS are mostly used for beams, bridges and thin structures. Then, the surface micromachining. This method uses sacrificial layers, grown during the fabrication process and then removed during the post process to let structures movable. These kinds of MEMS are often used for capacitive devices. Several types of MEMS are available from CMP, classified in 2 categories. First the bulk micromachining MEMS, based on standard CMOS and BiCMOS processes, for which structures are released with a post process step and without any additional mask. These 2 pairs of process/post process proposed by CMP allow to integrate both electronics and mechanical structures on the same circuit. The second category is the specific MEMS processes such as the MUMPS® family from MEMSCAP and SUMMiT V™ from Sandia, which are either surface or volume micromachining. On these processes, very advanced systems can be created on moveable platforms.

The Table 2 summarizes the MEMS processes available from CMP. The portfolio is large enough to imagine very complex mechanical structures with a solution for the fabrication. The designs can be complex either with the electronics management and control of the MEMS or in the movable structures. CMP also gives some support on MEMS design and provide the design kits on requests.

Integrated micromachining	Base Austriamicrosystems .35μ
	Base STMMicroelectronics .25μ BiCMOS post-process ASIMPS from CMU
Specific MEMS	PolyMUMPS from MEMSCAP
	MetalMUMPS from MEMSCAP
	SOIMUMPS from MEMSCAP
	SUMMiT V from SANDIA

Table 2: MEMS processes available

#### IV. OTHER MAJOR INFRASTRUCTURES

Many countries had pioneering efforts in the late 70s - early80s. These efforts are documented in [1]. The first cooperative initiative in Europe was EUROMOS in 1985, undertaken by CMP in France, Darmstadt in Germany, Norchip in Denmark, NIHE in Ireland. Next came the time of EUROCHIP and CHIPSHOP. Details can be found in [2].

Today, there are 7 major National services in the world: CIC in Taiwan, CMC in Canada, CMP in France, ICC in China, IDEC in Korea, MOSIS in the USA and VDEC in Japan. Three of them, CMC, CMP and MOSIS have decided in 2002 to cooperate. It might happen that further cooperations will be developed later on. CMP has been depicted in section II. A summary of the activities of CIC, CMC, ICC, IDEC, MOSIS and VDEC, can be found in [17]. Summaries can also be found in CMP Annual Reports.

#### V. ICS AND MEMS FOR BIOMED

BioMed applications of electronics and MEMS in general range from implant devices to biosensors, DNA-based systems analytical protein arrays and cell based systems [3]. Two basic technological prerequisites are micro-fluidic platforms and separation based tools on chips. The goal of this section is not to present an exhaustive panorama of all kinds of BioMed applications that can be reached with some types of electronics and MEMS, but only to address a few examples of what can be achieved with standard processes,

available for example from CMP. The users do not need to call for specific custom process developments, they only need to design, they do not need to care about the manufacturing.

##### A. CMOS FOR NEUROSCIENCES

CMOS ICs can be used for interfacing with cells and biological objects. Both ICs and neurons (and more generally electroactive cells) work electrically. Electrons and holes in semiconductors and ions in cells are the information carriers. Neurons transmit information along nerves through the action potential that is the depolarisation of their membrane. Due to differences in ion concentration between sides of the cell membrane, neurons present a negative potential inside the membrane. When membrane proteins open ions channels, a depolarisation occurs and propagates along the nerve, it is the propagation of the action potential. By placing a metallic or insulator/semiconductor structure in the vicinity of a neuron membrane, it is possible to measure the depolarisation and thus to access the electrical activity of cells.

In 1991, Peter Fromherz [4] has been working on silicon/neuron junction and then developed the first real connection between a neuron and an integrated circuit. These works have been pursued toward a greater integration and soon a real communication between an IC and a neuron [5-6] has been shown. By communication we mean initiation of an action potential in a neuron, propagation to other neurons and then reading of the signals in these other neurons through other microelectrodes in the IC.

The integration of real neuron networks with integrated circuits is a very promising technique for neuroscience. However some specific care must be taken for the coupling. For biocompatibility reasons, it is not possible to directly connect a culture medium to the surface of an integrated circuit. The aluminum as an example of metal present in ICs connection pads is not compatible with neurons. Several techniques have been develop to overcome this problem including the use of capacitive electrodes (silicon dioxide is biocomptabile) or the covering of metal electrodes with noble metals such as Platinum. It is shown as an example in the fig. 8 where a square platinum plate covers the top metal opening.

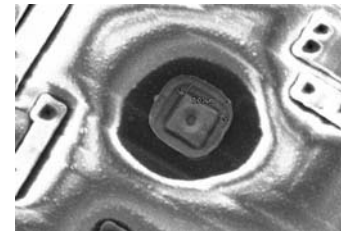

Fig. 8: SEM picture of the grid electrode of an ISFET covered with a platinum layer. This electrode is a part of an ISFET sensor matrix implemented on CMOS.

Apart from an electrical interface with electrically active cells, ICs have been used in several other bio applications such as the measure of ion concentration in the vicinity of cells. This has been done in the purpose to study ionic activity of cells (through membrane proteins) regarding the presence of drugs in the culture medium. In this case, several studies report the use of Ion Sensitive Field Effect Transistors to measure ionic concentration. Another

application in cell biology has been to use an IC for localisation and immobilisation of cells. In reference [7], authors have created an array of photodiodes / electrodes included in a microfluidic system. Once a cell is detected through the array of photodetectors it is kept trapped by means of a vertical dielectrophoretic well. This system allows the control of cells population on top of an integrated circuit.

All previously described applications have been developed to establish a measure of electrical or ionic activity of living neurons. On another hand, there is an intense research activity on the field of mimicking the behaviour of neurons and synapses in the goal of building artificial analog neuron networks. Neuron networks have been intensively studied and modelled using computers. In the case of neuromorphic ICs [8], a physical implementation of a neuron is made on silicon. It has the advantage of being real time and could be used both for the study of computing techniques and also in the goal of hybridation with a real neuron network. The figure 8 is an example of such an analog neuron network, it has been made by researchers in University of Bordeaux [8]. This chip emulates neurons electrical activity using a biophysical model (Hodgkin-Huxley formalism). Five neurons have been integrated and are fully tunable. Their model cards are stored in an analog memory cell array. Such ASICs, as shown in Figure 9, form the computation core of a complete simulation system dedicated to the investigation of the dynamics of biomimetic neural networks.

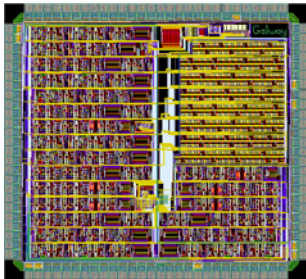

Fig. 9: A neuromimetic and modular ASIC: integration of biomimetic neurons

### B. BULK MICROMACHINING FOR BIOMED

Bulk micromachining allows the fabrication of various types of sensors for BioMed applications. In the following, an acoustic sensor for ORL surgery is briefly described.

#### Acoustic sensor for ORL surgery

This project is under development jointly at the TIMA Laboratory in Grenoble and at the Hopital Nord in Grenoble. In Oto-Rhino-Laryngology (ORL), the middle ear surgery aims at correcting certain types of hearing loss or in treating certain diseases. Among different kinds of techniques, the ossiculoplasty attempts to re-establish a connection between the tympanic membrane and the oval window. This surgery involves ossicular chain reparation or reconstruction with appropriate replacement prosthesis. Three elements of the ossicular chain (stapes, incus, and malleus), the smallest bones of the human body, provide the sound energy transfer between the tympanic membrane and the inner ear. Successful surgery can lead to the correction of hearing loss due to tympanic membrane anomalies or to a discontinuity or fractures of ear bones. There exists a number of different techniques leading to the ossicular chain reconstruction using either biomaterials or various other materials such as titanium, gold or ceramics. In spite of all this progress, the

surgical act in the middle ear remains difficult because of a large number of factors influencing its success. Moreover, there is no available means enabling per-operative monitoring and thus giving necessary feedback to the surgeon.

The project is aimed at the development of a micromachined vibration sensor working in the audible frequency range from 1 to 5 kHz is required by ORL surgeons. Such a sensor, used during a surgery, will make easier to a surgeon to take a decision whether the realized ossiculoplasty is providing an optimal transfer of the acoustic signal from the tympanic membrane to the inner ear. The simplified picture showing the human ear main parts as well as the procedure using the vibration sensor is in Fig. 10. A sound source located in front of the patient's outer ear generates a test signal that propagates through the external ear to the tympanic membrane. The movement of the tympanic membrane is transferred via the ossicular chain to the input of the inner ear represented by the oval window. The vibration sensor put in contact with any part of the ossicular chain will thus provide real-time information about its degree of mobility and about the quality of the propagated sound signal.

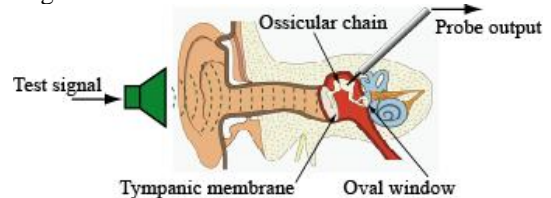

Fig. 10: Illustration of the basic parts of the human ear and of the use of the sensor.

The MEMS-based approach to the sensor design is motivated by the small size and low mechanical impedance of the ossicular chain. A micro-machined sensor tip will provide a possibility of the vibration measurement by a physical contact with no side effects to the ear function. A careful design of the sensor is required in order to overcome the ultra-low level of vibrations (see Fig. 11). The curve in Fig. 10 shows middle-ear displacement values generated by the sound pressure level of 80 dB on the tympanic membrane as obtained from the behavioral model of the ear.

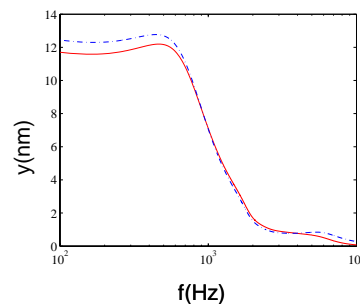

Fig. 11: Middle-ear bones displacements as a result of the behavioral model of the ear (sound level 80dB).

Different possible arrangements of the sensor are investigated. The sensor with a contact tip placed perpendicularly to the sensitive element composed of four arms equipped with piezoresistive gauges is shown in Fig. 12.



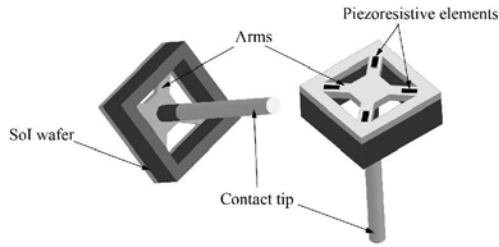

Fig. 12: Principle of the sensor structure.

The sensitive element of the sensor is made from the silicon-on-insulator (SOI) wafer. This kind of substrate facilitates the fabrication of arms with uniform thickness. The silicon arms are made by the front side micromachining. The whole sensitive structure is suspended on the cavity obtained with the deep reactive ion etch (DRIE) from the back side of the wafer. The contact tip is formed by a glass fiber attached with the etching of the bulk silicon layer. One of the results of the sensor structure FE modeling is shown in Fig. 13. The zones of maximal stress on the arms as a result of force load at the end of the tip can be identified here.

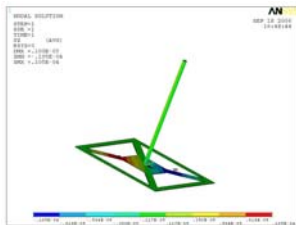

Fig. 13: Piezoresistive sensor structure FE modeling.

### C. MUMPS FOR BIOMED

MUMPS allow the manufacturing of devices in view of various BioMed applications. In the following are addressed successively research applications and commercial applications.

#### 1). Research applications

The following examples are coming from Canadian Universities. The projects have been collected by CMC. CMC is the Canadian Microelectronics Corporation, a Service similar to CMP, servicing the Canadian Universities. The first example is coming from the University of Calgary, Electrical & Computer Eng. (Karan Kaler, Martin P. Mintchev, Electronic Mosquito: A Semi-Invasive MEMS for Blood Sampling and Analysis”). The device would extract blood like a mosquito would, electronically analyze the sample and then transmit it to a wireless device to monitor and control the insulin infusion pump so that the glucose balance in the body of a diabetic patient is maintained throughout the day. The Fig. 14 depicts more in detail the device. The following is taken from the designers.

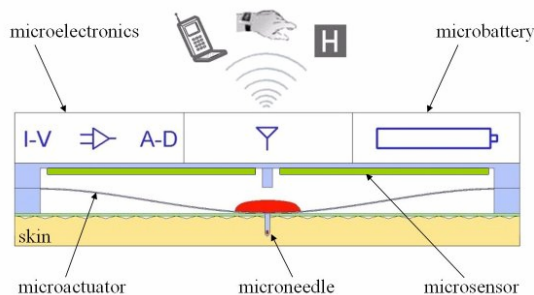

Fig. 14: The e-Mosquito™ cell: device building blocks include microneedle, microactuator, microsensor, microelectronics, and

microbattery [courtesy from the University of Calgary]

The very small volume of blood (<1ml) delivered by the sampling process is stored in a miniature blood compartment, where the microsensor converts the blood element of interest (for example, the glucose level) into an electrical signal. This automated and self-calibrated procedure is performed by a microsensor integrated inside the blood compartment.

The major building blocks consist of: (1) a microneedle; (2) a microactuator integrated with the microneedle; (3) a microsensor implemented inside a blood-collecting compartment; (4) a microelectronic stage including analog signal conditioning, analog-to-digital converter, controlling electronic circuitry, and digital radio-frequency transceiver; (5) a microbattery providing the energy to operate the MEMS device; (6) an associated packaging to protect the delicate microsystem inside; (7) an adhesive and antiseptic layer placed between the skin surface and the device; and (8) an enclosing band-aid to attach the e-Mosquito™ patch safely onto the skin. An array of single-use and individually actuated e-Mosquito™ cells form the disposable patch and a matrix of 180 e-Mosquito™ cells can provide periodic blood sampling for up to one week, assuming that blood monitoring is required every hour.

An other example comes from Dalhousie University, Mechanical Engineering Department. Ted Hubbard et al. developed a microgripper in view of mechanical testing of cells and bacteria, cell manipulation, medical screening. Initial designs were made on MUMPS, they next moved to Micragem, a SOI MEMS technology from Micralyne, that is available from CMC. The following is taken from [9]. An electrothermal microgripper is used. Typical displacements for chevron actuators are in the range of a few micrometres, so mechanical amplifiers are needed to increase the motion. Fig. 15 shows a chevron actuator with a set of two closed-toggle-style amplifiers, one for each jaw of the gripper. A small displacement downward (along the y- axis) at the centre of the chevron actuator (3) draws in the gripper jaws (6) significantly. The amplifiers (5) are mechanically connected to the actuators (3), and therefore current also flows through them. This means that they will also heat up and thermally expand. To take advantage of this current, the amplifiers are designed to act as hot/cold-arm-type thermal actuators, where the thin-finned hot arm of the actuator is on the outside, contributing to the inward, closing motion of the jaws (6).

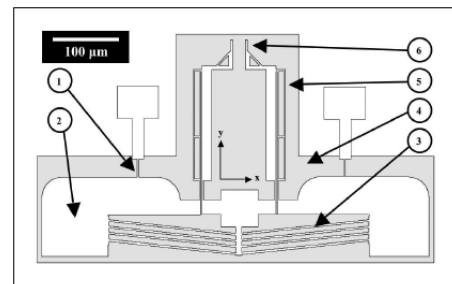

Fig. 15: Design of an off-chip gripper: (1) breakable tether; (2) bonding pad; (3) chevron actuator; (4) cavity; (5) amplifiers; (6) jaws [9]

The gripper is able to grasp 5 µm spheres.

#### 2) Commercial applications

The following examples are coming from MEMSCAP. The

products did not come directly from MUMPS, but MUMPS have served as test vehicles to test various components. The first example is a pressure sensor MEMSCAP is manufacturing for CardioMEMS. The wireless pressure sensor is inserted during the minimally invasive repair of abdominal aortic aneurysms (AAA) or thoracic aortic aneurysms (TAA), via a catheter into a patient's aneurysm sac. The small size, durability, and lack of wires and batteries enable system to last for, and transmit data over, the lifetime of the patient without requiring repeated procedures (Fig. 16).



Fig. 16: Wireless AAA pressure sensor from CARDIOMEMS

The second example is a wireless imaging system made for Given Imaging in view of endoscopy. The tiny camera contained in a capsule captures images of the gastrointestinal tract as it travels through the body and transmits the images to a computer so a physician can view them and make a diagnosis (Fig. 17).



Fig. 17: PillCam Capsule from Given Imaging

#### D. ASIMPS FOR BIOMED

ASIMPS from Carnegie-Mellon University allow the design of BioMed applications. Here is an example: a bone implantable stress sensor. The following is taken from [10]. The clinical management of skeletal trauma and disease relies on radiographic imaging to infer bone quality. However, bone strength does not necessarily correlate well with image intensity. There is a need for a safe and convenient way to measure bone strength in situ. The goal is to present a new technique to directly measure bone strength in situ at a micro-level scale through a MEMS sensor. The proposed MEMS stress imager comprises an array of piezoresistive sensor "pixels" to detect stress across the interfacial area between the MEMS chip and bone with resolution to 100 Pa, in 1 sec averaging. The sensors are integrated within a textured surface to accommodate sensor integration into bone. From initial research, surface topography with 30-60  $\mu\text{m}$  features was found to be conducive to guiding new cell growth. Finite Element Analysis (FEA) has led to a sensor design for normal and shear stress detection.

The Fig. 18 pictures the MEMS device that includes the piezoresistive sensor array, and a coil antenna for RF power and telemetry. The interest for clinicians is that if they had a

practical means to directly measure and quantify biomechanical properties of healing or diseased bone in situ, within bone, this capability could provide improved and timely information for treatment management options, including drugs, fixation adjustments, rehabilitation regimens, or pre-emptive surgical intervention.

In contrast to the local nature of the validation in single sensor experiments, an array of piezoresistive elements offers the possibility of global data over an entire surface on the order of 1-4  $\text{mm}^2$ .

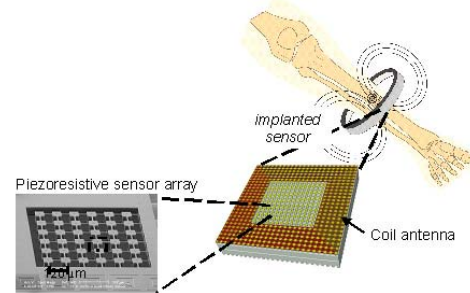

Fig. 18: Bone Implantable Stress Sensor [10]

#### E. A SYSTEM VIEW: BIOMED SCIENCE AND BEAUTY

This last section gives a detailed example of a whole system including various kinds of sensors, ASICs for signal processing, data acquisition, expert systems, etc. It is coming from IntuiSkin, a wholly owned subsidiary of the MEMSCAP Group. IntuiSkin is focused on innovative, technology based skin care solutions. These solutions provide an answer to the new and strong consumer demand for technology based cosmetology. They allow to characterize the skin in general, in order to recommend suitable cosmetic treatments. The general concept of IntuiSkin is depicted in Fig. 19 [11]. The various MEMS sensors are grouped into 2 probes measuring many basic parameters of the skin.

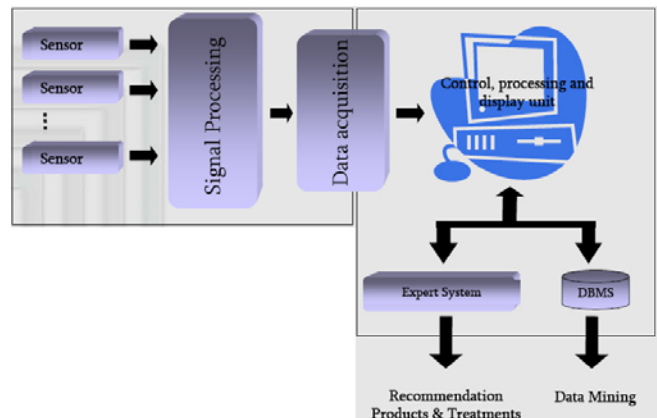

Fig. 19: IntuiSkin general concept [11]

The Visio probe uses its sensors to capture with an extreme precision the skin images. The system enables many measurements including wrinkles, sebum, hairiness, dark spots and clogged pores/bacterial infection. The Physio probe contains sensors and extracts in vivo the key characteristics of the skin. This probe measures, among other parameters, the hydration, the trans-epidermal water loss (TEWL), and the skin temperature. The 2 probes and a few examples of the measured parameters are depicted in Fig. 20.



Fig. 20: The probes and examples of measured parameters [11]

Several equipments and products have been derived by IntuiSkin to address various needs. The Skin Evidence is addressing the medical market. It is an answer to the practitioner needs in cure and detection as well as in specific treatments (peeling, injection, fillers,...) as well as to the clinician in pre and post surgical support. It is expected that the system will be used by skin specialists, dermatologists, dermato-cosmeticians, plastic surgeons in their clinics or in their office.

The other market addressed by the general concept of IntuiSkin is the beauty market. The IOMA Beauty Diag™ is measuring the 7 main dysfunctions of the skin: hydration and UV damage, fine lines, wrinkles and elasticity, redness, bacterial infection, sebum, dark spots. It is expected that aestheticians will use the equipment to recommend the best treatments.

## VI. CONCLUSIONS

Several conclusive facets are addressed. A first one is dealing with BioMed [12]. Next, directions for service organizations like CMP are discussed.

### A. WHAT IS IMPORTANT FOR THE BIOMED COMMUNITY?

Many kinds of BioMed applications have been addressed in this paper, ranging from neurosciences to surgery aid, to endoscopy, to skin treatment. Many other kinds of applications might be devised in the future. Going further from dermatology for example, hardware devices might be designed in view of the coming market dealing with dermonutrition or nutricosmetics, depending on the way companies are coming from. Danone is offering yoghurts "nourishing the skin from inside", and L'Oreal is offering with Nestle nutritional food fighting the skin aging: nutraceuticals with cosmetic benefits (the so-called beauty pills). In both cases, the efficiency can be scientifically measured by specific devices.

What is important for the BioMed community is that Education and Research should take advantage of these infrastructures, in the same way as Education and Research in microelectronics have taken advantage of these infrastructures in the 80s. At that time, these infrastructures offered the possibility to EE and CS students, teachers, researchers, to focus on the design of complex circuits hence to focus on the applications, because these infrastructures gave them the opportunity not to be burdened by the manufacturing processes, nor by the cost of their projects. Today, various CMOS and MEMS processes can allow students, teachers, researchers to focus on BioMed applications. Not all possible applications can be reached by standard processes offered by service organizations like CMP, but these service organizations are continuously expanding their portfolios. CMC from Canada recently introduced, for example, access to a microfluidics platform.

In addition to fixtures for custom fluidic microchips, it gains advantage from multiple technologies--photonics, electronics and embedded software, and pushes further the set of BioMed applications targeted by teachers, researchers and students.

### B. WHERE SHOULD SERVICE ORGANIZATIONS LIKE CMP GO?

Remarks on today and tomorrow directions are addressed.

#### 1) Today: cooperation is a must

Key issues at CMP in 2007 have been:

- More and more circuits: +25% from 2005 to 2006, +22% from 2006 to 2007
- Industrial circuits is maintained to about 20% of the total number of circuits and low volume production is provided up to tens of wafers
- A large portfolio of technologies (17 different processes from low cost processes to very advanced ones) for ICs and MEMS

CMP is doing well, as other service organisations. But no single service organization can offer a very large portfolio of its own. Cooperation between service organizations is a must.

Long time ago, CMP had a cooperation with CIC in Taiwan. Presently, the major cooperative effort is undertaken by CMC, CMP and MOSIS. These 3 infrastructure services announced it in June 2002. Since then, the cooperation has been steadily expanding [13]. CMP has also set up cooperations with ICC in China and with IDEC in Korea. Separately, CMP has also set up a number of bilateral cooperations with special groups in various countries, and has established distributors in several parts of the world.

#### 2) Tomorrow

Several comments are addressed in the following, according to 2 broad lines:

- more Moore
- more than Moore

and 2 considerations:

- going global
- being excellent

### More Moore

It has been recognized that Students, Researchers and SME designers must be provided with the possibility to have their circuits fabricated. From its inception in 1981, CMP has been successfully pursuing this goal and experiencing a very significant growth to reach and to keep its present level. The success is partly due to the basic principles which have been governing the choices of the Service: use of industrial and advanced process lines. Advanced processes are more and more necessary because of the need for very skilled designers and because CAD industrial software is more widely available to Universities (instead of University CAD software). Since new versions of CAD software are targeted to industrial use, there is no choice but to use advanced processes. Industry makes also more and more use of the Service. During the 80s, the CMP processes were not very advanced, but they approached more and more industry state of the art during the 90s, because of CAD software reasons and because of the increasing industry use of CMP. Since then, CMP has been always offering state of the art processes.

But cost and acceptance are slowing down the use of ever advanced processes. Practical difficulties are popping up like



power density, temperature, variability, leakage power, analog design, etc. The costs are rising high if circuits are not manufactured in very large volumes. A way to overcome the cost issue while keeping costs reasonable is to go for larger die sizes on current-generation geometrics. But anyway fundamental limits coming from thermodynamics, quantum mechanics, electromagnetics, ... will set show stoppers sooner or later.

#### More than Moore

The quest for always larger densities may also be satisfied with 3D integration, possibly not including very advanced process dies for cost reasons. System in package integration (SiP) allows heterogeneous integration, like sensors, electronics, etc. opposed to systems on chip (SoC) in which all parts are manufactured on the same process, which is not always optimal.

3D processes using TSVs (Through Silicon Vias) allow to go one step further: interconnections are shorter, hence leading to power savings and better performance, there are less I/Os so less power is consumed. Heterogeneous integration is also possible as for SiP. There are still concerns to be addressed like thermal issues (increased density may lead to hot spots, electromigration,...), power (no power savings if current-generation geometrics are used), CAD software. CMP will introduce soon 3D processes using TSVs.

A step further may be required for some applications where the substrate is required to be flexible, like for many BioMed applications. Organic electronics allow 3D integration as well, for a cheap cost, for large areas, for heterogeneous integration. Biocompatibility is also a plus for BioMed applications. B. KAMINSKA et al. have introduced in [14] a good example of such systems. A multilayer polymer microsensor system allows skin tissue conformity since the substrate can bend up to 30°. It includes various sensors, signal conditioning, processing, RF communication, powering from disposable or rechargeable batteries. The prototype includes electrodes for ECG and a MEMS accelerometer for body positioning calculation.

It is also recognized that complementary developments must be addressed, in order to address more diversified needs. With this respect, CMP has been a pioneer in being the first service in the world to offer MEMS processes as early as 1995. Going further, more than mechanics-electronics is to be addressed like photonics, optics, fluidics, etc. CMP will be actively promoting these developments in the future.

#### Going global

The cooperation between service organizations has already been mentioned.

On the side of the users of CMP and of other similar services, the design way is also going more and more global in the sense that more and more IP blocks may come from various sources. This is due to the ever increasing complexity of designs, including parts coming from various teams, countries, companies, etc. An initiative is being developed to go this way: the Global Education for Microelectronic Systems (GEMS) [15].

#### Being excellent

Globalization also requires to be excellent in order to stay ahead of others. This is important at the time of global markets, when every country or continent is a high cost country or continent to another one. Some countries or continents that were said to be "low-cost" countries or continents a few years ago already experience that other countries or continents are coming to the picture with lower costs, forcing them to outsource their own outsourcing [16]. The way to combat that is to stay ahead of the others. The way to stay ahead is to educate and research using top level electronic processes available from top level services like CMP.

## VI. REFERENCES

- [1] "MPC Services available worldwide", B. Courtois invited paper, APCCAS'94 IEEE Asia-Pacific Conference on Circuits and Systems, December 5-8 1994, Grand Hotel, Taipei, Taiwan.
- [2] "Infrastructures for Education and Research: from National Initiatives to Worldwide Development", B. Courtois invited talk, Technical University of Darmstadt, M. GLESNER 60th birthday ceremony, 29 August 2003.
- [3] "BioMEMS", Edited by G. URBAN, Springer, 2006.
- [4] "A Neuron Silicon Junction : A Retzius Cell of the Leech on an Insulated Gate Field Effect Transistor", P. Fromherz et al., Science n° 1952, pp. 1290-1293, 1991.
- [5] "Silicon-Neuron Junction: Capacitive Stimulation of an Individual Neuron on a Silicon Chip", P. Fromherz, A. Stett, Physical Revue Letter, n° 75, pp. 1670a 1673, 1995.
- [6] "A 128x128 Bio-sensor array for extracellular recording of neural activity", P. Fromherz et al. International Solid State Circuits Conference (ISSCC), 2003.
- [7] "A CMOS Chip for Individual Cell Manipulation and Detection", N. Manaresi et al. IEEE Journal of Solid-State Circuits, Vol.38, n°12, 2003.
- [8] "Neuromimetic ICs with analog cores: an alternative for simulating spiking neural networks ", S. Renaud et al. in Proceedings of the IEEE 2007 International Symposium on Circuits And Systems, (ISCAS'07), New-Orleans, USA, 2007, pp. 3355-3358.
- [9] "Theoretical and experimental analysis of an off-chip microgripper", J. Fraser, T. Hubbard, M. Kujath, Can. J. Elect. Comput. Eng., Vol.31, No.2, Spring 2006.
- [10] "BioImplantable Bone Stress Sensor", F. Alfaro et al, Proc. of the Int' Conf. of IEEE Engineering in Medicine and Biology Society (EMBS), Shanghai, China, Sept. 1-4, 2005.
- [11] "Panel on success stories in MEMS-based systems", J.M Karam, Design, Test, Integration and Packaging of MEMS and MOEMS Conference, Nice, France, 9-11 April 2008.
- [12] "Infrastructures for Education, Research and Industry: CMOS and MEMS for BioMed", Courtois B., Charlot B., Di Pendina G., Rufer L., *Invited paper* at the 12<sup>th</sup> World Multi-Conference on Systemics, Cybernetics and Informatics (WMSCI 2008), Orlando USA, 29 June – 2 July 2008.
- [13] CMC, CMP and MOSIS "The Scale of Cooperation Increases as the Dimensions of Microchips Decrease" C. Pina, B. Courtois, D. Gale, *Invited paper*, 3<sup>rd</sup> International Conference on Microelectronic Systems Education, 1-2 June 2003, Anaheim, USA.
- [14] "Multiparameter Single Locus Integrated Multilayer Polymer Microsensor System", Yindar Chuo, Bozena Kaminska, to appear in IEEE Trans. on BIOCaS.
- [15] "Global Education for Microelectronic Systems, www.ieee-gems.edu" Rucinski A.
- [16] India outsources its own outsourcing – Pioneer nation fends off new rivals, International Herald Tribune – 25 September 2007.
- [17] "Integrated Circuit Brokers: Where do they come from? Where are they heading?", B. Courtois, *Keynote* at International Conference on Microelectronics, 14-17 December 2008, Sharjah, UAE