New robust coil sensors for near field characterization

Benjamin Vincent, Olivier Chadebec, Jean-Luc Schanen
G2Elab – Grenoble (France)

C. A. F. Sartori and L. Krähenbühl
LMAG – São Paulo
Ampère – Lyon (France)



Equivalent magnetic Source : the concept



Real source :
very complicated
magnetic behavior



Equivalent magnetic Source : the concept



Real source :

*very complicated
magnetic behavior*

$$\begin{aligned} \vec{B} = & \frac{1}{r^3} (s_{1,-1} \vec{B}_{1,-1} + s_{1,0} \vec{B}_{1,0} + s_{1,1} \vec{B}_{1,1}) \\ & + \frac{1}{r^4} (s_{2,-2} \vec{B}_{2,-2} + s_{2,-1} \vec{B}_{2,-1} + s_{2,0} \vec{B}_{2,0} + s_{2,1} \vec{B}_{2,1} + s_{2,2} \vec{B}_{2,2}) \\ & + \frac{1}{r^5} (s_{3,-3} \vec{B}_{3,-3} + s_{3,-2} \vec{B}_{3,-2} + s_{3,-1} \vec{B}_{3,-1} + s_{3,0} \vec{B}_{3,0} + s_{3,1} \vec{B}_{3,1} + s_{3,2} \vec{B}_{3,2} + s_{3,3} \vec{B}_{3,3}) \\ & + \frac{1}{r^6} (\dots) + \frac{1}{r^7} (\dots) + \dots \end{aligned}$$

Equivalent magnetic Source : the concept



$n=1$: dipolar behavior

Real source :

*very complicated
magnetic behavior*

$$\vec{B} = \frac{1}{r^3} (s_{1,-1} \vec{B}_{1,-1} + s_{1,0} \vec{B}_{1,0} + s_{1,1} \vec{B}_{1,1})$$

$$+ \frac{1}{r^4} (s_{2,-2} \vec{B}_{2,-2} + s_{2,-1} \vec{B}_{2,-1} + s_{2,0} \vec{B}_{2,0} + s_{2,1} \vec{B}_{2,1} + s_{2,2} \vec{B}_{2,2})$$

$$+ \frac{1}{r^5} (s_{3,-3} \vec{B}_{3,-3} + s_{3,-2} \vec{B}_{3,-2} + s_{3,-1} \vec{B}_{3,-1} + s_{3,0} \vec{B}_{3,0} + s_{3,1} \vec{B}_{3,1} + s_{3,2} \vec{B}_{3,2} + s_{3,3} \vec{B}_{3,3})$$

$$+ \frac{1}{r^6} (\dots) + \frac{1}{r^7} (\dots) + \dots$$

Equivalent magnetic Source : the concept



n=1 : dipolar behavior

n=2 : quadripolar behavior

Real source :

*very complicated
magnetic behavior*

$$\vec{B} = \frac{1}{r^3} (s_{1,-1} \vec{B}_{1,-1} + s_{1,0} \vec{B}_{1,0} + s_{1,1} \vec{B}_{1,1})$$

$$+ \frac{1}{r^4} (s_{2,-2} \vec{B}_{2,-2} + s_{2,-1} \vec{B}_{2,-1} + s_{2,0} \vec{B}_{2,0} + s_{2,1} \vec{B}_{2,1} + s_{2,2} \vec{B}_{2,2})$$

$$+ \frac{1}{r^5} (s_{3,-3} \vec{B}_{3,-3} + s_{3,-2} \vec{B}_{3,-2} + s_{3,-1} \vec{B}_{3,-1} + s_{3,0} \vec{B}_{3,0} + s_{3,1} \vec{B}_{3,1} + s_{3,2} \vec{B}_{3,2} + s_{3,3} \vec{B}_{3,3})$$

$$+ \frac{1}{r^6} (\dots) + \frac{1}{r^7} (\dots) + \dots$$

Equivalent magnetic Source : the concept



$n=1$: dipolar behavior

$n=2$: quadripolar behavior

$n \geq 3$: higher orders behavior

Real source :

*very complicated
magnetic behavior*

$$\vec{B} = \frac{1}{r^3} (s_{1,-1} \vec{B}_{1,-1} + s_{1,0} \vec{B}_{1,0} + s_{1,1} \vec{B}_{1,1})$$

$$+ \frac{1}{r^4} (s_{2,-2} \vec{B}_{2,-2} + s_{2,-1} \vec{B}_{2,-1} + s_{2,0} \vec{B}_{2,0} + s_{2,1} \vec{B}_{2,1} + s_{2,2} \vec{B}_{2,2})$$

$$+ \frac{1}{r^5} (s_{3,-3} \vec{B}_{3,-3} + s_{3,-2} \vec{B}_{3,-2} + s_{3,-1} \vec{B}_{3,-1} + s_{3,0} \vec{B}_{3,0} + s_{3,1} \vec{B}_{3,1} + s_{3,2} \vec{B}_{3,2} + s_{3,3} \vec{B}_{3,3})$$

$$+ \frac{1}{r^6} (\dots) + \frac{1}{r^7} (\dots) + \dots$$

Equivalent magnetic Source : the concept

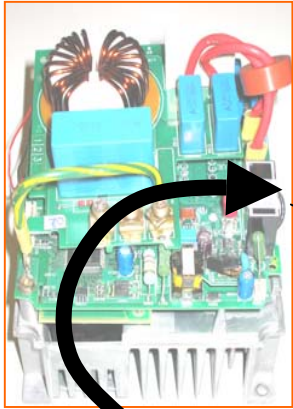

Sensor $S_{1,-1}$

$n=1$: dipolar behavior

$n=2$: quadripolar behavior

$n \geq 3$: higher orders behavior

Real source :
very complicated
magnetic behavior

$$\vec{B} = \frac{1}{r^3} (s_{1,-1} \vec{B}_{1,-1} + s_{1,0} \vec{B}_{1,0} + s_{1,1} \vec{B}_{1,1})$$

$$+ \frac{1}{r^4} (s_{2,-2} \vec{B}_{2,-2} + s_{2,-1} \vec{B}_{2,-1} + s_{2,0} \vec{B}_{2,0} + s_{2,1} \vec{B}_{2,1} + s_{2,2} \vec{B}_{2,2})$$

$$+ \frac{1}{r^5} (s_{3,-3} \vec{B}_{3,-3} + s_{3,-2} \vec{B}_{3,-2} + s_{3,-1} \vec{B}_{3,-1} + s_{3,0} \vec{B}_{3,0} + s_{3,1} \vec{B}_{3,1} + s_{3,2} \vec{B}_{3,2} + s_{3,3} \vec{B}_{3,3})$$

$$+ \frac{1}{r^6} (\dots) + \frac{1}{r^7} (\dots) + \dots$$



Equivalent magnetic Source : the concept

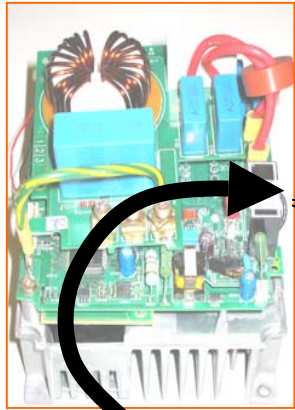

Real source :
very complicated
magnetic behavior

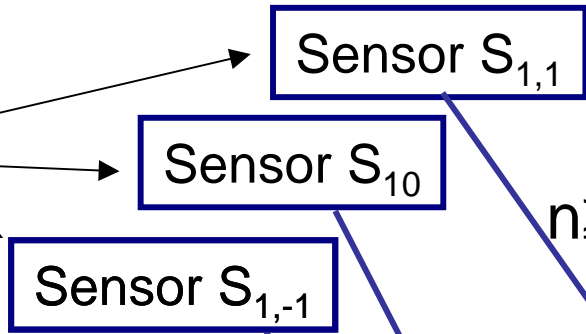

$n=1$: dipolar behavior

$n=2$: quadripolar behavior

$n \geq 3$: higher orders behavior

$$\vec{B} = \frac{1}{r^3} (s_{1,-1} \vec{B}_{1,-1} + s_{1,0} \vec{B}_{1,0} + s_{1,1} \vec{B}_{1,1})$$

$$+ \frac{1}{r^4} (s_{2,-2} \vec{B}_{2,-2} + s_{2,-1} \vec{B}_{2,-1} + s_{2,0} \vec{B}_{2,0} + s_{2,1} \vec{B}_{2,1} + s_{2,2} \vec{B}_{2,2})$$

$$+ \frac{1}{r^5} (s_{3,-3} \vec{B}_{3,-3} + s_{3,-2} \vec{B}_{3,-2} + s_{3,-1} \vec{B}_{3,-1} + s_{3,0} \vec{B}_{3,0} + s_{3,1} \vec{B}_{3,1} + s_{3,2} \vec{B}_{3,2} + s_{3,3} \vec{B}_{3,3})$$

$$+ \frac{1}{r^6} (\dots) + \frac{1}{r^7} (\dots) + \dots$$



CENTRE NATIONAL
DE LA RECHERCHE
SCIENTIFIQUE



2008
Florianópolis - Santa Catarina

Equivalent magnetic Source : the concept



Real source
Very complicated
magnetic behavior

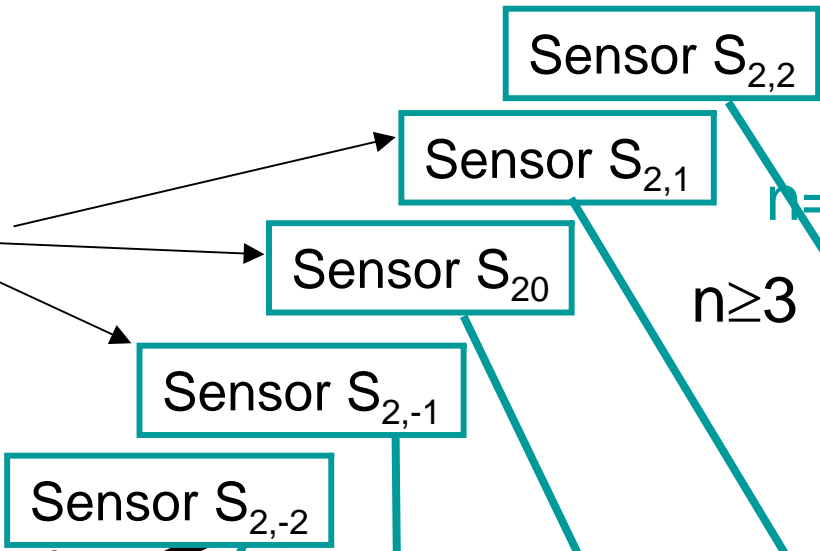

n=1 : dipolar behavior

n=2 : **quadripolar behavior**

n ≥ 3 : higher orders behavior

$$\vec{B} = -\frac{1}{r^3} (s_{1,-1} \vec{B}_{1,-1} + s_{1,0} \vec{B}_{1,0} + s_{1,1} \vec{B}_{1,1})$$

$$+ \frac{1}{r^4} (s_{2,-2} \vec{B}_{2,-2} + s_{2,-1} \vec{B}_{2,-1} + s_{2,0} \vec{B}_{2,0} + s_{2,1} \vec{B}_{2,1} + s_{2,2} \vec{B}_{2,2})$$

$$+ \frac{1}{r^5} (s_{3,-3} \vec{B}_{3,-3} + s_{3,-2} \vec{B}_{3,-2} + s_{3,-1} \vec{B}_{3,-1} + s_{3,0} \vec{B}_{3,0} + s_{3,1} \vec{B}_{3,1} + s_{3,2} \vec{B}_{3,2} + s_{3,3} \vec{B}_{3,3})$$

$$+ \frac{1}{r^6} (\dots) + \frac{1}{r^7} (\dots) + \dots$$



The standard sensors

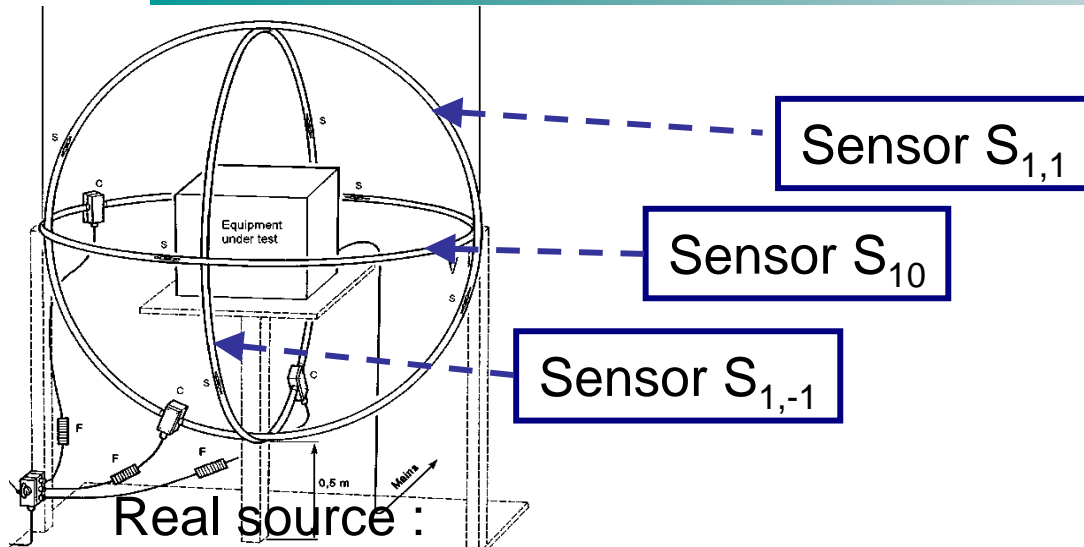

Real source :
 very complicated
 magnetic behavior

$$\begin{aligned}
 \vec{B} = & \frac{1}{r^3} (s_{1,-1} \vec{B}_{1,-1} + s_{1,0} \vec{B}_{1,0} + s_{1,1} \vec{B}_{1,1}) \\
 & + \frac{1}{r^4} (s_{2,-2} \vec{B}_{2,-2} + s_{2,-1} \vec{B}_{2,-1} + s_{2,0} \vec{B}_{2,0} + s_{2,1} \vec{B}_{2,1} + s_{2,2} \vec{B}_{2,2}) \\
 & + \frac{1}{r^5} (s_{3,-3} \vec{B}_{3,-3} + s_{3,-2} \vec{B}_{3,-2} + s_{3,-1} \vec{B}_{3,-1} + s_{3,0} \vec{B}_{3,0} + s_{3,1} \vec{B}_{3,1} + s_{3,2} \vec{B}_{3,2} + s_{3,3} \vec{B}_{3,3}) \\
 & + \frac{1}{r^6} (\dots) + \frac{1}{r^7} (\dots) + \dots
 \end{aligned}$$



The standard sensors

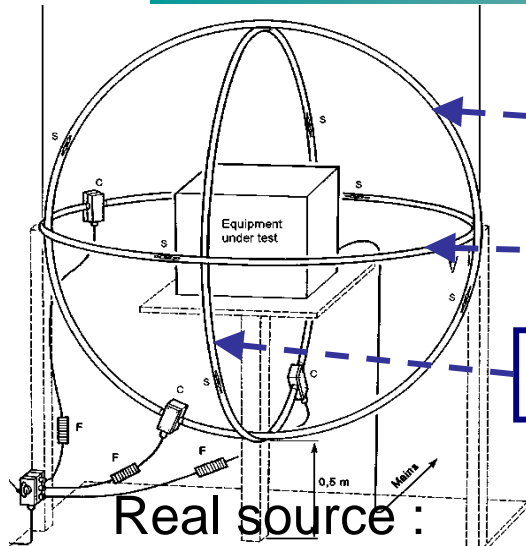

Sensor $S_{1,1}$

$$s_{1,1} + \varepsilon_{1,1}(n \geq 3)$$

Sensor $S_{1,0}$

$$s_{1,0} + \varepsilon_{1,0}(n \geq 3)$$

Sensor $S_{1,-1}$

$$s_{1,-1} + \varepsilon_{1,-1}(n \geq 3)$$

Real source :
very complicated
magnetic behavior

$$\vec{B} = \frac{1}{r^3} (s_{1,-1} \vec{B}_{1,-1} + s_{1,0} \vec{B}_{1,0} + s_{1,1} \vec{B}_{1,1})$$

$$+ \frac{1}{r^4} (s_{2,-2} \vec{B}_{2,-2} + s_{2,-1} \vec{B}_{2,-1} + s_{2,0} \vec{B}_{2,0} + s_{2,1} \vec{B}_{2,1} + s_{2,2} \vec{B}_{2,2})$$

$$+ \frac{1}{r^5} (s_{3,-3} \vec{B}_{3,-3} + s_{3,-2} \vec{B}_{3,-2} + s_{3,-1} \vec{B}_{3,-1} + s_{3,0} \vec{B}_{3,0} + s_{3,1} \vec{B}_{3,1} + s_{3,2} \vec{B}_{3,2} + s_{3,3} \vec{B}_{3,3})$$

$$+ \frac{1}{r^6} (\dots) + \frac{1}{r^7} (\dots) + \dots$$



The standard sensors

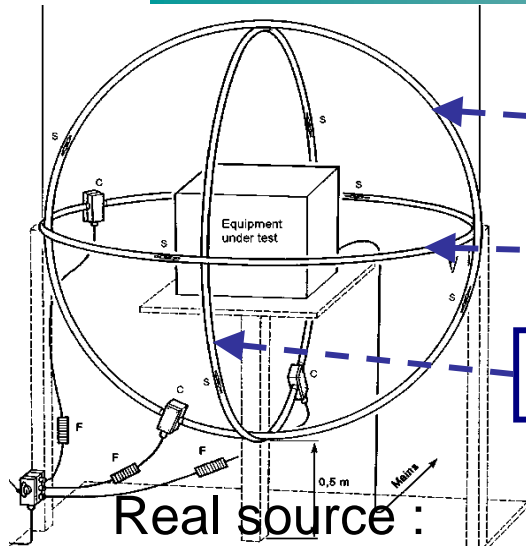

Sensor $S_{1,1}$

$$s_{1,1} + \varepsilon_{1,1}(n \geq 3)$$

Sensor $S_{1,0}$

$$s_{1,0} + \varepsilon_{1,0}(n \geq 3)$$

Sensor $S_{1,-1}$

$$s_{1,-1} + \varepsilon_{1,-1}(n \geq 3)$$

Real source :
very complicated
magnetic behavior

$$\vec{B} = \frac{1}{r^3} (s_{1,-1} \vec{B}_{1,-1} + s_{1,0} \vec{B}_{1,0} + s_{1,1} \vec{B}_{1,1})$$

$$+ \frac{1}{r^4} (s_{2,-2} \vec{B}_{2,-2} + s_{2,-1} \vec{B}_{2,-1} + s_{2,0} \vec{B}_{2,0} + s_{2,1} \vec{B}_{2,1} + s_{2,2} \vec{B}_{2,2})$$

$$+ \frac{1}{r^5} (s_{3,-3} \vec{B}_{3,-3} + s_{3,-2} \vec{B}_{3,-2} + s_{3,-1} \vec{B}_{3,-1} + s_{3,0} \vec{B}_{3,0} + s_{3,1} \vec{B}_{3,1} + s_{3,2} \vec{B}_{3,2} + s_{3,3} \vec{B}_{3,3})$$

$$+ \frac{1}{r^6} (\dots) + \frac{1}{r^7} (\dots) + \dots$$

The standard sensors

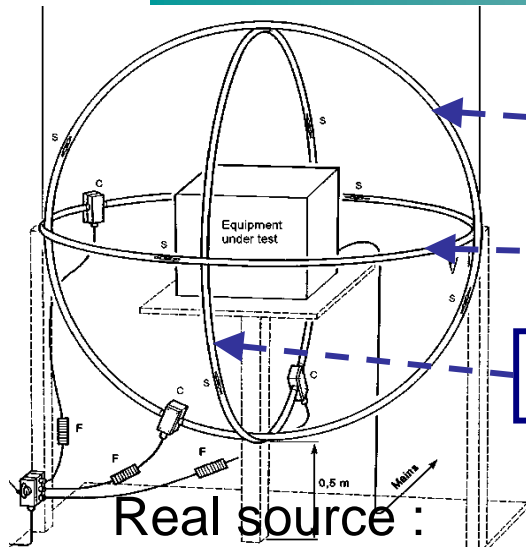

Sensor $S_{1,1}$

$$s_{1,1} + \varepsilon_{1,1}(n \geq 3)$$

Sensor S_{10}

$$s_{1,0} + \varepsilon_{1,0}(n \geq 3)$$

Sensor $S_{1,-1}$

$$s_{1,-1} + \varepsilon_{1,-1}(n \geq 3)$$

Real source :
very complicated
magnetic behavior

$$\vec{B} = \frac{1}{r^3} (s_{1,-1} \vec{B}_{1,-1} + s_{1,0} \vec{B}_{1,0} + s_{1,1} \vec{B}_{1,1})$$

$$+ \frac{1}{r^4} (s_{2,-2} \vec{B}_{2,-2} + s_{2,-1} \vec{B}_{2,-1} + s_{2,0} \vec{B}_{2,0} + s_{2,1} \vec{B}_{2,1} + s_{2,2} \vec{B}_{2,2})$$

$$+ \frac{1}{r^5} (s_{3,-3} \vec{B}_{3,-3} + s_{3,-2} \vec{B}_{3,-2} + s_{3,-1} \vec{B}_{3,-1} + s_{3,0} \vec{B}_{3,0} + s_{3,1} \vec{B}_{3,1} + s_{3,2} \vec{B}_{3,2} + s_{3,3} \vec{B}_{3,3})$$

$$+ \frac{1}{r^6} (\dots) + \frac{1}{r^7} (\dots) + \dots$$



Design a new family of sensors



8 sensors
 $S_{1,-1}$ S_{10} S_{11}
 $S_{2,-2}$ $S_{2,-1}$ S_{20} S_{21} S_{22}

Real source :

*very complicated
magnetic behavior*

$$\vec{B} = \frac{1}{r^3} (s_{1,-1} \vec{B}_{1,-1} + s_{1,0} \vec{B}_{1,0} + s_{1,1} \vec{B}_{1,1})$$

$$+ \frac{1}{r^4} (s_{2,-2} \vec{B}_{2,-2} + s_{2,-1} \vec{B}_{2,-1} + s_{2,0} \vec{B}_{2,0} + s_{2,1} \vec{B}_{2,1} + s_{2,2} \vec{B}_{2,2})$$

$$+ \frac{1}{r^5} (s_{3,-3} \vec{B}_{3,-3} + s_{3,-2} \vec{B}_{3,-2} + s_{3,-1} \vec{B}_{3,-1} + s_{3,0} \vec{B}_{3,0} + s_{3,1} \vec{B}_{3,1} + s_{3,2} \vec{B}_{3,2} + s_{3,3} \vec{B}_{3,3})$$

$$+ \frac{1}{r^6} (\dots) + \frac{1}{r^7} (\dots) + \dots$$



Design a new family of sensors

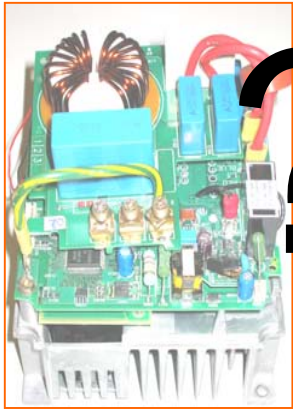

8 sensors
 $S_{1,-1}$ S_{10} S_{11}
 $S_{2,-2}$ $S_{2,-1}$ S_{20} S_{21} S_{22}

dipolar & quadripolar behaviors

$S_{1,-1}$ S_{10} S_{11}

$S_{2,-2}$ $S_{2,-1}$ S_{20} S_{21} S_{22}

Real source :

*very complicated
magnetic behavior*

$$\vec{B} = \frac{1}{r^3} (s_{1,-1} \vec{B}_{1,-1} + s_{1,0} \vec{B}_{1,0} + s_{1,1} \vec{B}_{1,1})$$

$$+ \frac{1}{r^4} (s_{2,-2} \vec{B}_{2,-2} + s_{2,-1} \vec{B}_{2,-1} + s_{2,0} \vec{B}_{2,0} + s_{2,1} \vec{B}_{2,1} + s_{2,2} \vec{B}_{2,2})$$

$$+ \frac{1}{r^5} (s_{3,-3} \vec{B}_{3,-3} + s_{3,-2} \vec{B}_{3,-2} + s_{3,-1} \vec{B}_{3,-1} + s_{3,0} \vec{B}_{3,0} + s_{3,1} \vec{B}_{3,1} + s_{3,2} \vec{B}_{3,2} + s_{3,3} \vec{B}_{3,3})$$

$$+ \frac{1}{r^6} (\dots) + \frac{1}{r^7} (\dots) + \dots$$



Design a new family of sensors



8 sensors
 $S_{1,-1}$ S_{10} S_{11}
 $S_{2,-2}$ $S_{2,-1}$ S_{20} S_{21} S_{22}

dipolar & quadripolar behaviors

$$S_{1,-1} \quad S_{10} \quad S_{11}$$

$$S_{2,-2} \quad S_{2,-1} \quad S_{20} \quad S_{21} \quad S_{22} \quad + \epsilon_{ij} (n \geq 5)$$

Real source :
 very complicated
 magnetic behavior

$$\vec{B} = \frac{1}{r^3} (s_{1,-1} \vec{B}_{1,-1} + s_{1,0} \vec{B}_{1,0} + s_{1,1} \vec{B}_{1,1})$$

$$+ \frac{1}{r^4} (s_{2,-2} \vec{B}_{2,-2} + s_{2,-1} \vec{B}_{2,-1} + s_{2,0} \vec{B}_{2,0} + s_{2,1} \vec{B}_{2,1} + s_{2,2} \vec{B}_{2,2})$$

$$+ \frac{1}{r^5} (s_{3,-3} \vec{B}_{3,-3} + s_{3,-2} \vec{B}_{3,-2} + s_{3,-1} \vec{B}_{3,-1} + s_{3,0} \vec{B}_{3,0} + s_{3,1} \vec{B}_{3,1} + s_{3,2} \vec{B}_{3,2} + s_{3,3} \vec{B}_{3,3})$$

$$+ \frac{1}{r^6} (\dots) + \frac{1}{r^7} (\dots) + \dots$$



Design a new family of sensors

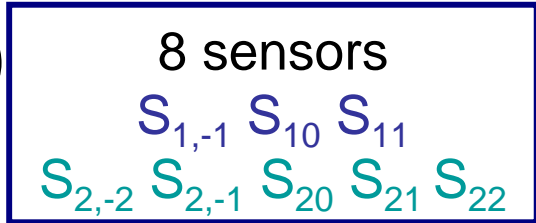
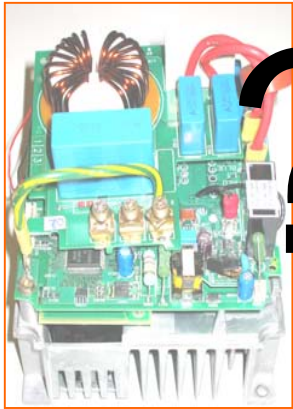

dipolar & quadripolar behaviors

$$\begin{aligned}
 & S_{1,-1} \quad S_{10} \quad S_{11} \\
 & S_{2,-2} \quad S_{2,-1} \quad S_{20} \quad S_{21} \quad S_{22} + \epsilon_{ij} (n \geq 5)
 \end{aligned}$$

Real source :

very complicated magnetic behavior

$$\begin{aligned}
 \vec{B} = & \frac{1}{r^3} (s_{1,-1} \vec{B}_{1,-1} + s_{1,0} \vec{B}_{1,0} + s_{1,1} \vec{B}_{1,1}) \\
 & + \frac{1}{r^4} (s_{2,-2} \vec{B}_{2,-2} + s_{2,-1} \vec{B}_{2,-1} + s_{2,0} \vec{B}_{2,0} + s_{2,1} \vec{B}_{2,1} + s_{2,2} \vec{B}_{2,2}) \\
 & - \frac{1}{r^5} (s_{3,-3} \vec{B}_{3,-3} + s_{3,-2} \vec{B}_{3,-2} + s_{3,-1} \vec{B}_{3,-1} + s_{3,0} \vec{B}_{3,0} + s_{3,1} \vec{B}_{3,1} + s_{3,2} \vec{B}_{3,2} + s_{3,3} \vec{B}_{3,3}) \\
 & - \frac{1}{r^6} (\dots) + \frac{1}{r^7} (\dots) + \dots
 \end{aligned}$$

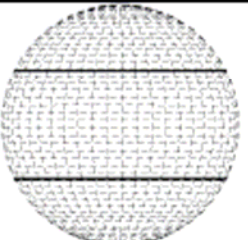
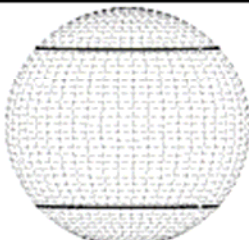
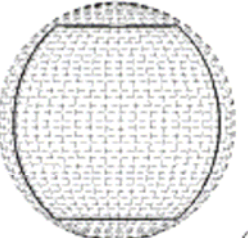
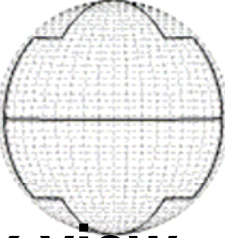
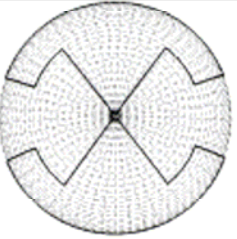
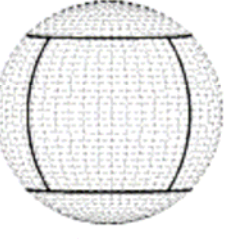
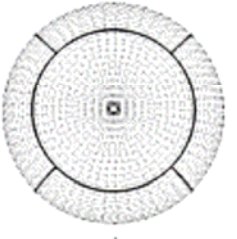

The results *(Benjamin Vincent CEFC 2008)*

Shape of the sensors			
	<i>first order (n = 1)</i>	<i>second order (n = 2)</i>	
$m = 0$	1 	3 	
$m = +/-1$	2  (1) (2)	4  x view x view (1) (2)	 z view
$m = +/-2$		5  x view (1) (2)	 z view

8 strange sensors to extract 8 components of the near field ...

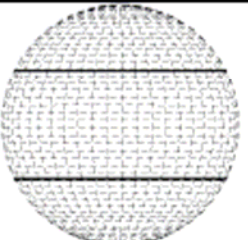
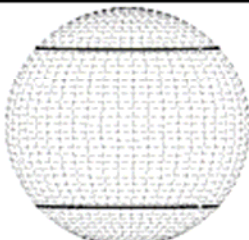
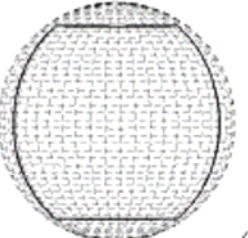
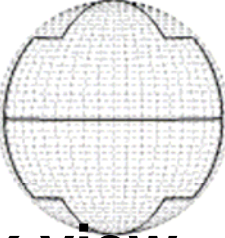
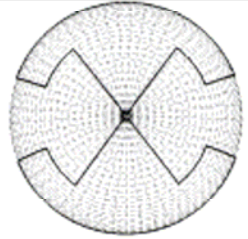
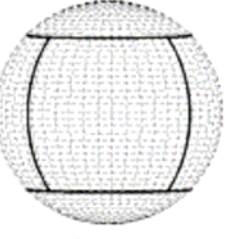
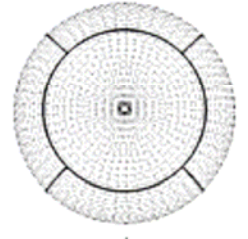

The results *(Benjamin Vincent CEFC 2008)*

Shape of the sensors		
	first order ($n=1$)	second order ($n=2$)
$m=0$	1 	3 
$m=+/-1$	2 2 positions: 0° 90°  (1) (2)	4 0° 45° x view  (1) (2) z view 
	5 different shapes	5 0° 45°  x view (1) (2)  z view

8 strange sensors to extract 8 components of the near field ...

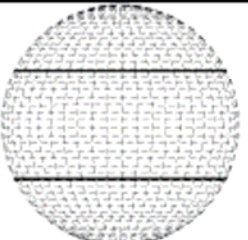
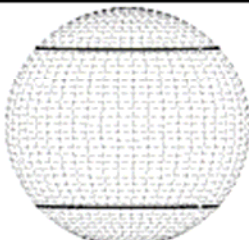
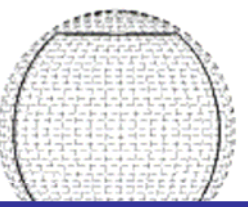
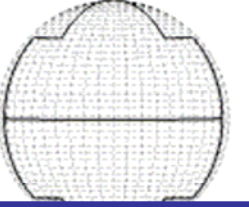
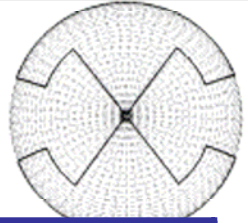

The results *(Benjamin Vincent CEFC 2008)*

Shape of the sensors		
	first order ($n=1$)	second order ($n=2$)
$m=0$	1 	3 
$m=+/-1$	2 	4  

2 positions : 0°

0°

5 dit

This presentation :

- how can we design these sensors using a systematic approach ?
- sensors outlines : on the surface of a sphere.
- theoretical tool : “spherical harmonics”

N

field ...



DE LA RECHERCHE SCIENTIFIQUE



2008 Florianópolis - Santa Catarina

Basic concepts

- Spherical harmonics ...

$$\vec{B}(r, \theta, \varphi) = -\frac{\mu_0}{4\pi} \sum_{n=1}^{+\infty} \sum_{m=-n}^{+n} A_{nm} \cdot \vec{\nabla} \left(r^{-(n+1)} \cdot Y_{nm}(\theta, \varphi) \right)$$

Orthogonal complete expansion

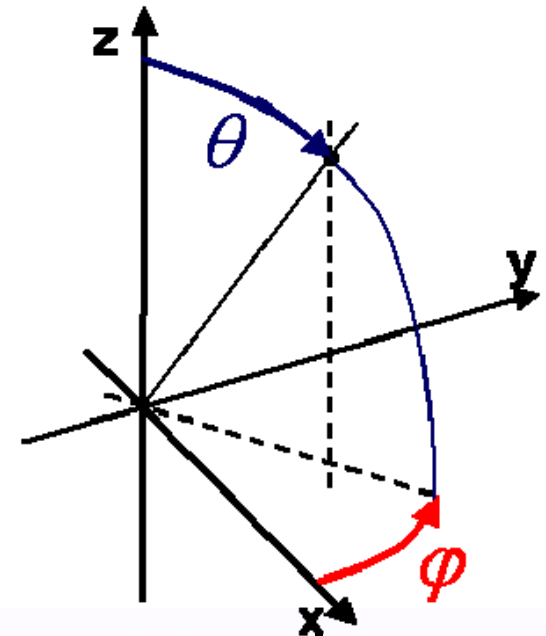

Basic concepts

- Spherical harmonics ...

$$\vec{B}(r, \theta, \varphi) = -\frac{\mu_0}{4\pi} \sum_{n=1}^{+\infty} \sum_{m=-n}^{+n} A_{nm} \cdot \vec{\nabla} \left(r^{-(n+1)} Y_{nm}(\theta, \varphi) \right)$$

Orthogonal complete expansion

- Flux density on a sphere

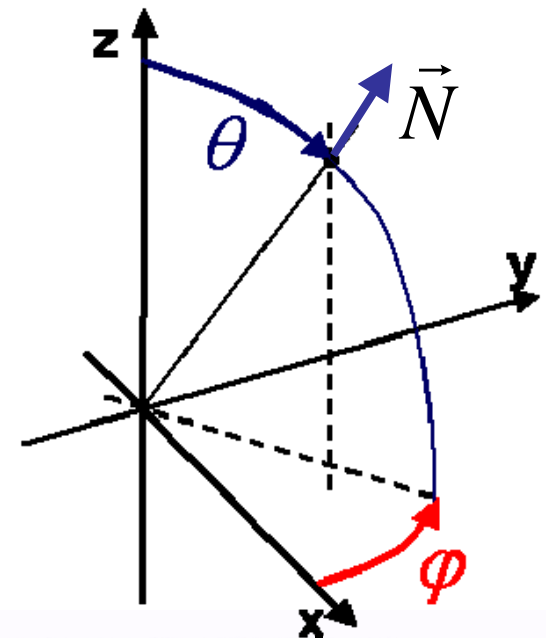

Basic concepts

- Spherical harmonics ...

$$\vec{B}(r, \theta, \varphi) = -\frac{\mu_0}{4\pi} \sum_{n=1}^{+\infty} \sum_{m=-n}^{+n} A_{nm} \cdot \vec{\nabla} \left(r^{-(n+1)} Y_{nm}(\theta, \varphi) \right)$$

Orthogonal complete expansion

- Flux density on a sphere

$$\vec{B}_{nm}(\vartheta, \varphi) \cdot \vec{N} \quad \text{prop. to} \quad Y_{nm}(\vartheta, \varphi)$$

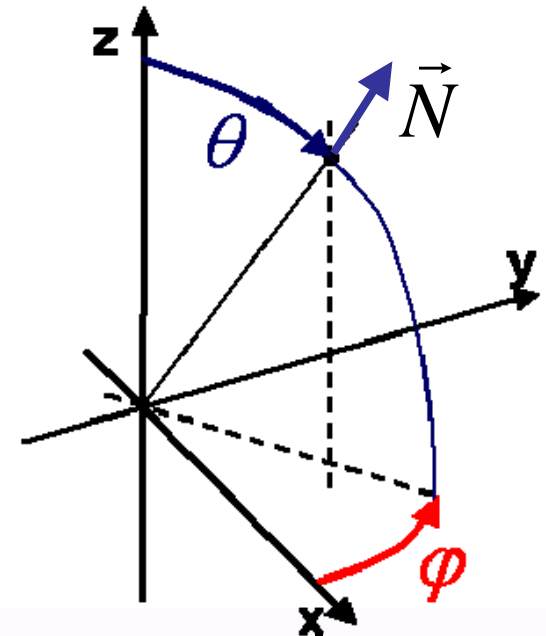

Basic concepts

- Spherical harmonics ...

$$\vec{B}(r, \theta, \varphi) = -\frac{\mu_0}{4\pi} \sum_{n=1}^{+\infty} \sum_{m=-n}^{+n} A_{nm} \cdot \vec{\nabla} \left(r^{-(n+1)} Y_{nm}(\theta, \varphi) \right)$$

Orthogonal complete expansion

- Flux density on a sphere

$$\vec{B}_{nm}(\vartheta, \varphi) \cdot \vec{N} \quad \text{prop. to} \quad Y_{nm}(\vartheta, \varphi)$$

Flux in a surface coil
proportional to :

$$\iint_{\text{sensor}} Y_{nm}(\vartheta, \varphi)$$

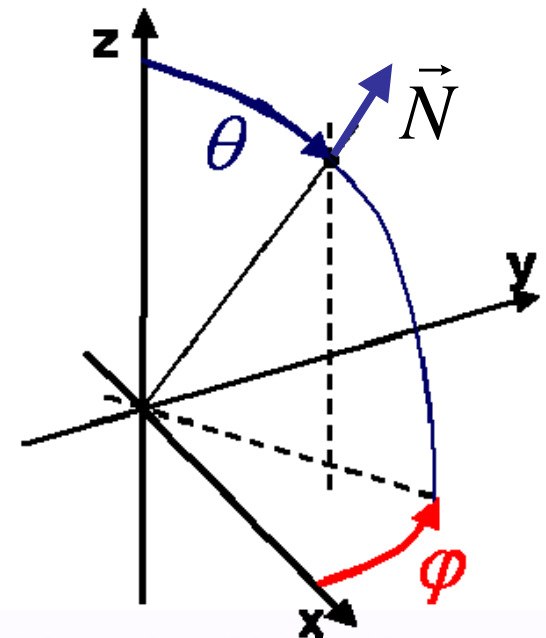

Spherical harmonics

$$Y_{nm}(\theta, \varphi) = P_{nm}(\cos \theta) \cdot \begin{cases} \sin(m\varphi) & m < 0 \\ \cos(m\varphi) & m \geq 0 \end{cases}$$

↓
Geometrical function of θ
 symmetric or antisymm.
 /plane xOy

↓
Geom. funct. of φ
 sinusoidal,
 m periods / turn

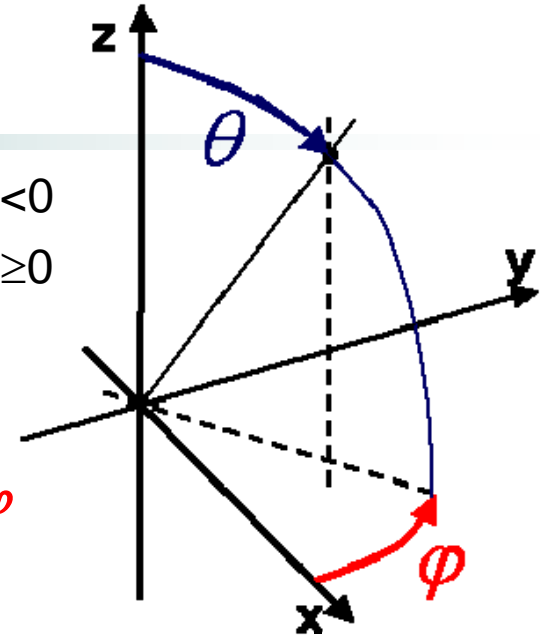

Spherical harmonics

$$Y_{nm}(\theta, \varphi) = P_{nm}(\cos\theta) \cdot \begin{cases} \sin(m\varphi) & m < 0 \\ \cos(m\varphi) & m \geq 0 \end{cases}$$

Geometrical function of θ
symmetric or antisymm.
/plane xOy

Geom. funct. of φ
sinusoidal,
m periods / turn

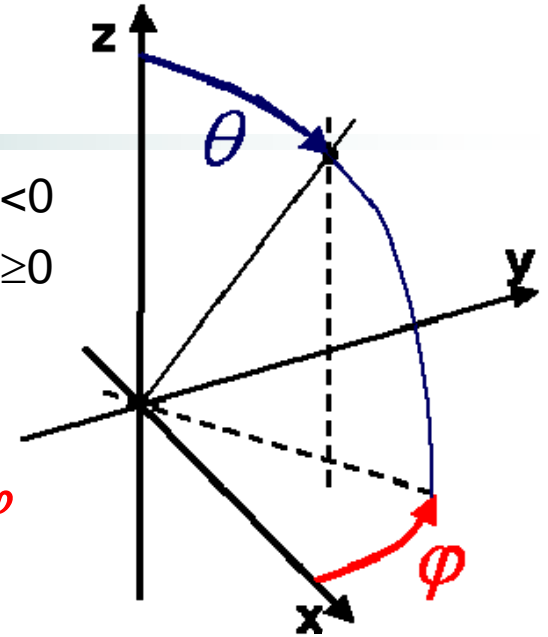

$$\vec{B}(r, \theta, \varphi) = -\frac{\mu_0}{4\pi} \sum_{n=1}^{+\infty} \sum_{m=-n}^{+n} A_{nm} \cdot \vec{\nabla} \left(r^{-(n+1)} \cdot Y_{nm}(\theta, \varphi) \right)$$

Spherical harmonics

$$Y_{nm}(\theta, \varphi) = P_{nm}(\cos\theta) \cdot \begin{cases} \sin(m\varphi) & m < 0 \\ \cos(m\varphi) & m \geq 0 \end{cases}$$

Geometrical function of θ
symmetric or antisymm.
/plane xOy

Geom. funct. of φ
sinusoïdal,
m periods / turn

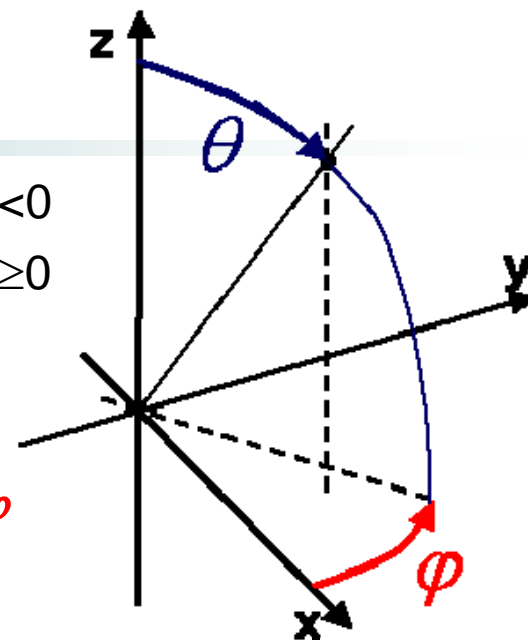

$$\vec{B}(r, \theta, \varphi) = -\frac{\mu_0}{4\pi} \sum_{n=1}^{+\infty} \sum_{m=-n}^{+n} A_{nm} \cdot \vec{\nabla} \left(r^{-(n+1)} \cdot Y_{nm}(\theta, \varphi) \right)$$

n=1 : 3 terms

n=2 : 5 terms

n=3 : 7 terms

n=4 : 9 terms

n=5 : 11 terms

	$Y_{1,-1}$	$Y_{1,0}$	$Y_{1,1}$						
	$Y_{2,-2}$	$Y_{2,-1}$	$Y_{2,0}$	$Y_{2,1}$	$Y_{2,2}$				
	$Y_{3,-2}$	$Y_{3,-1}$	$Y_{3,0}$	$Y_{3,1}$	$Y_{3,2}$	$Y_{3,3}$			
	$Y_{4,-4}$	$Y_{4,-3}$	$Y_{4,-2}$	$Y_{4,-1}$	$Y_{4,0}$	$Y_{4,1}$	$Y_{4,2}$	$Y_{4,3}$	$Y_{4,4}$
								

Y_{mn}	Flux
r^{-3}	r^{-1}
r^{-4}	r^{-2}
r^{-5}	r^{-3}
r^{-6}	r^{-4}
r^{-7}	r^{-5}

Spherical harmonics

$$Y_{nm}(\theta, \varphi) = P_{nm}(\cos\theta)$$

Geometrical function of θ
 symmetric or antisymm.
 /plane xOy

$\sin(m\varphi)$ $m < 0$
 $\cos(m\varphi)$ $m \geq 0$

Geom. funct. of φ
 sinusoidal,
 m periods / turn

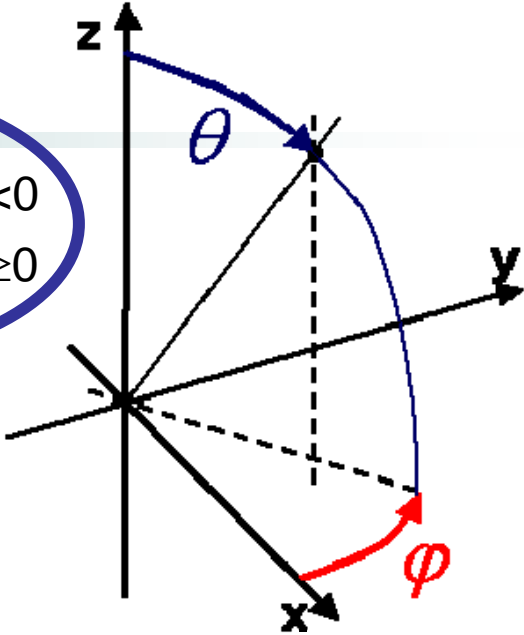

- n=1 : 3 terms
- n=2 : 5 terms
- n=3 : 7 terms
- n=4 : 9 terms
- n=5 : 11 terms

	$Y_{1,-1}$	$Y_{1,0}$	$Y_{1,1}$						
		$Y_{2,-2}$	$Y_{2,-1}$	$Y_{2,0}$	$Y_{2,1}$	$Y_{2,2}$			
			$Y_{3,-2}$	$Y_{3,-1}$	$Y_{3,0}$	$Y_{3,1}$	$Y_{3,2}$	$Y_{3,3}$	
	$Y_{4,-4}$	$Y_{4,-3}$	$Y_{4,-2}$	$Y_{4,-1}$	$Y_{4,0}$	$Y_{4,1}$	$Y_{4,2}$	$Y_{4,3}$	$Y_{4,4}$

Y_{mn}	Flux
r^{-3}	r^{-1}
r^{-4}	r^{-2}
r^{-5}	r^{-3}
r^{-6}	r^{-4}
r^{-7}	r^{-5}



Spherical harmonics

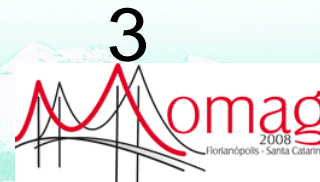
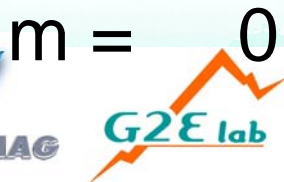
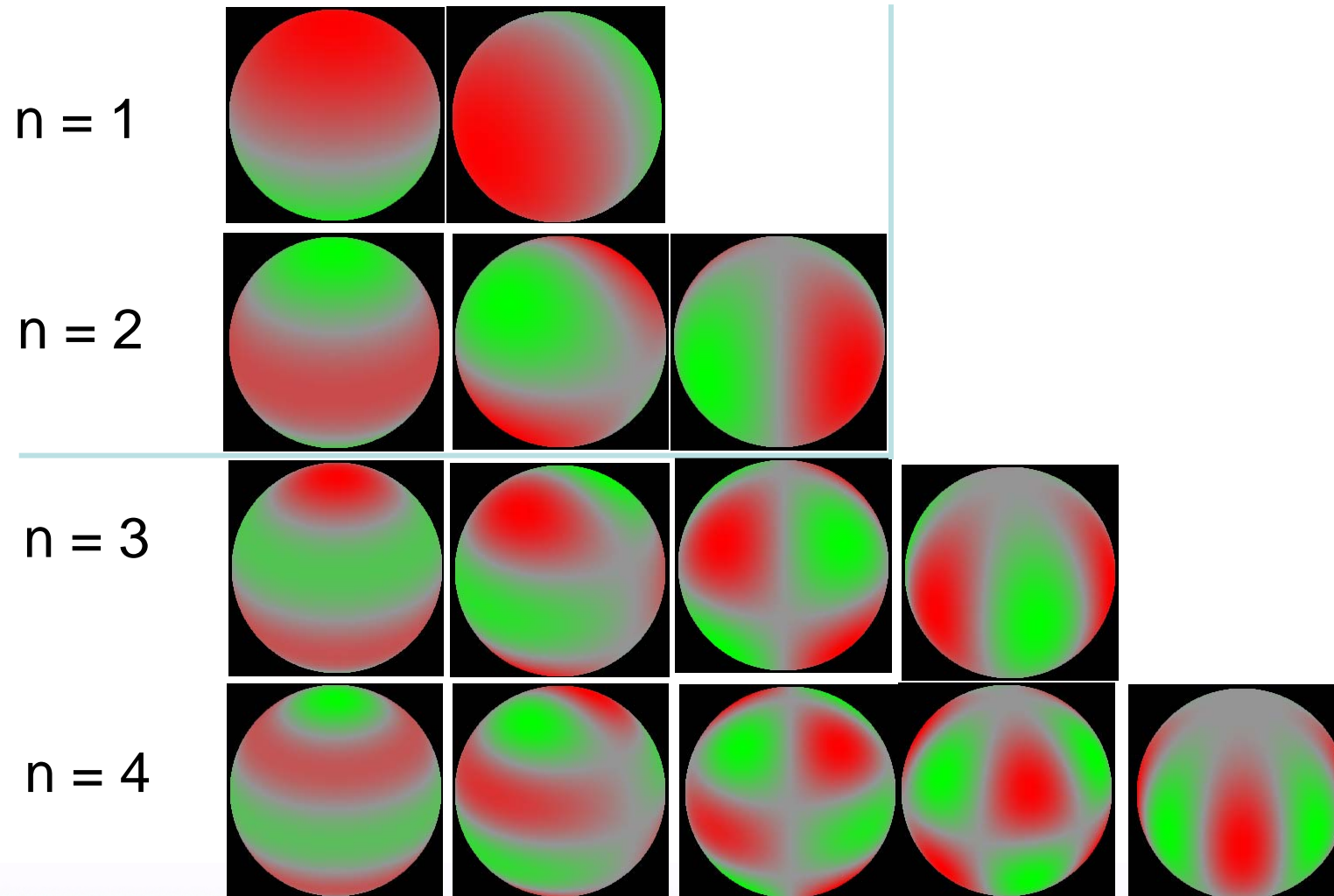

Sph. Harm. : symmetrical Y_{nm} (/ $z=0$)

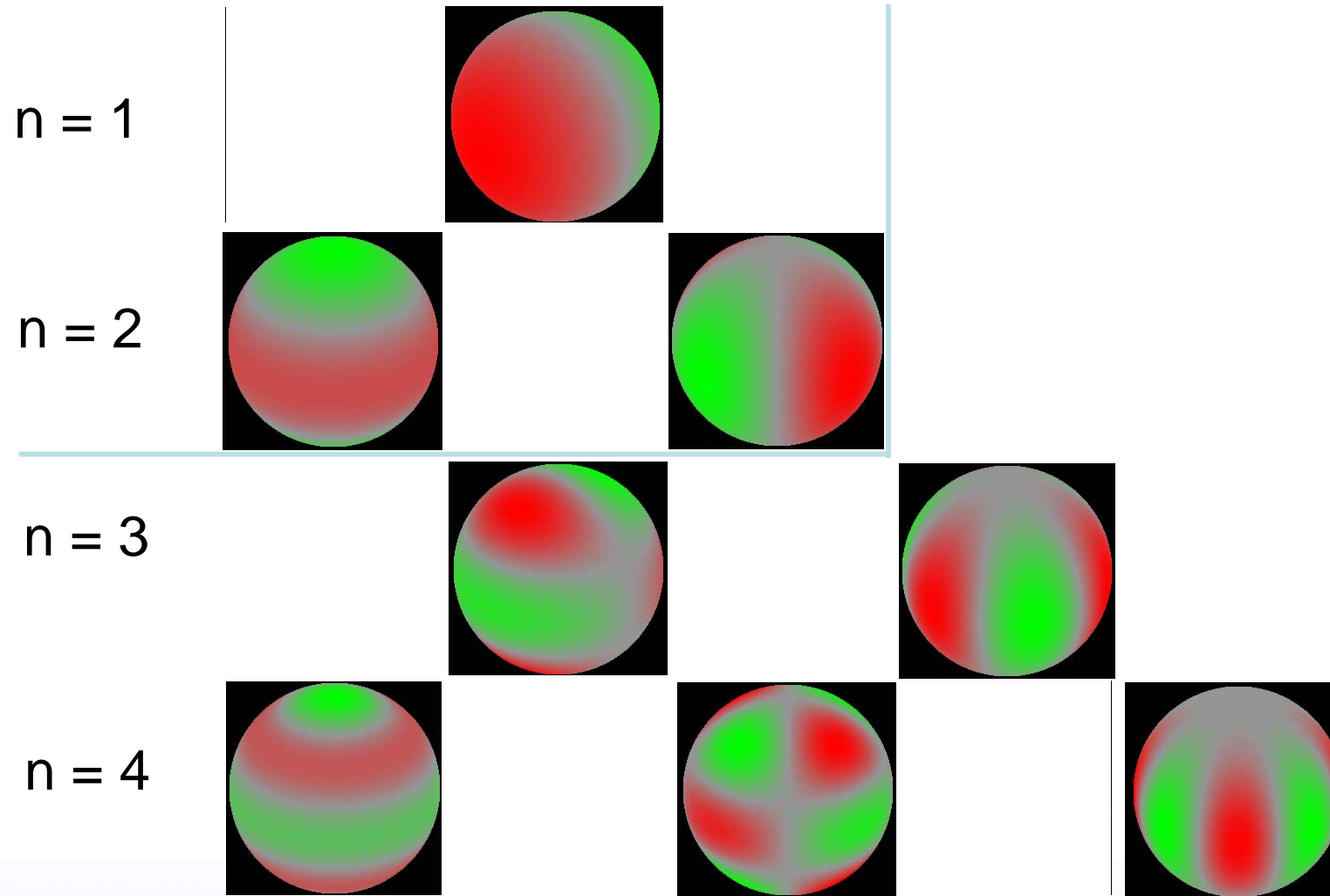

Sph. Harm. : symmetrical Y_{nm} (/ $z=0$)

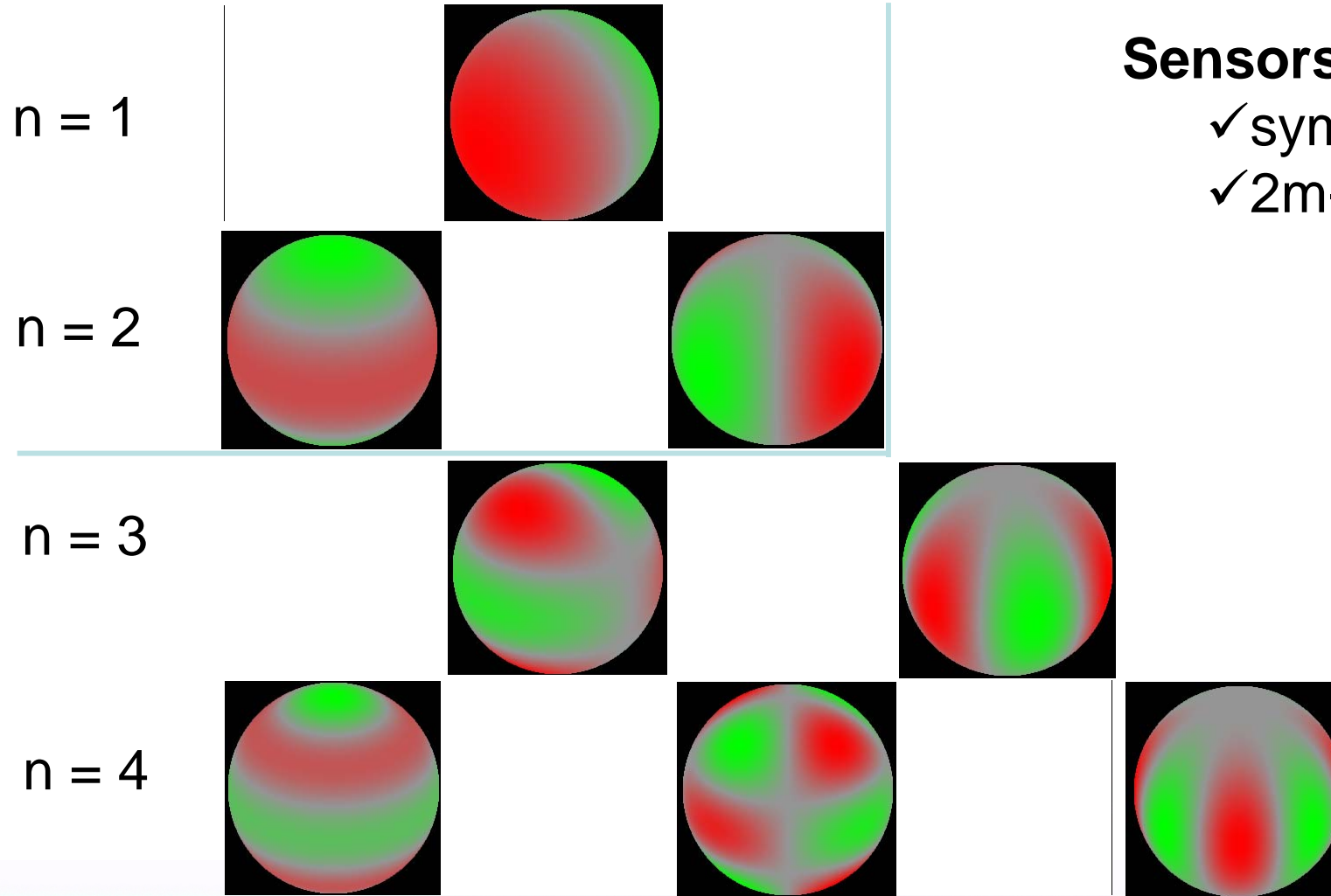

Sensors nm:

- ✓ symmetric / $z=0$
- ✓ $2m$ -antiperiodic

Sph. Harm. : symmetrical Y_{nm} (/ $z=0$)

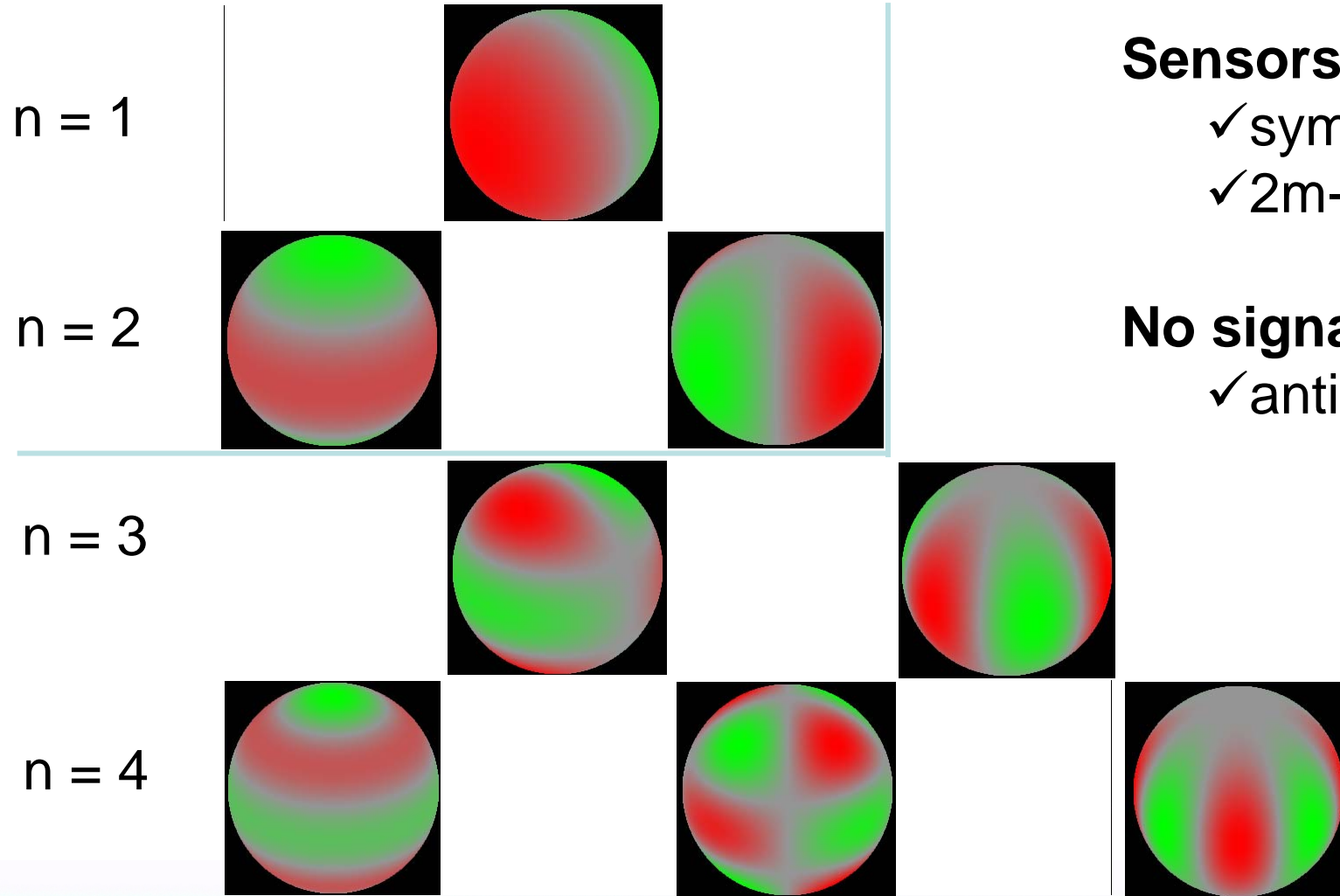

Sensors nm:

- ✓ symmetric / $z=0$
- ✓ $2m$ -antiperiodic

No signal for :

- ✓ antisym. $Y_{m'n'}$

Sph. Harm. : symmetrical Y_{nm} (/ $z=0$)

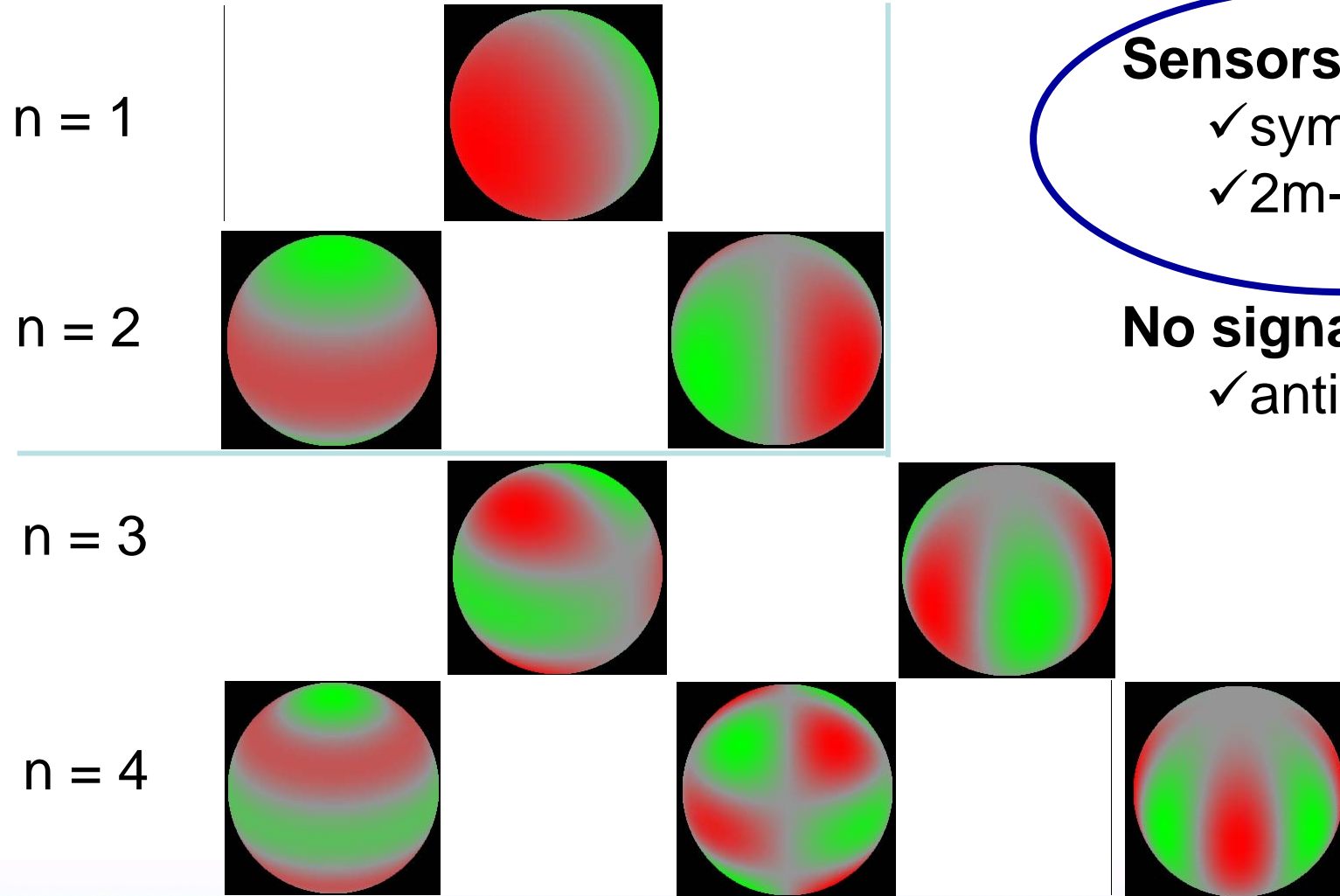

Sensors nm:
 ✓ symmetric / $z=0$
 ✓ $2m$ -antiperiodic

No signal for :
 ✓ antisym. $Y_{m'n'}$

Symm. sensors nm:

✓ symmetric / $z=0$

✓ $2m$ -antiperiodic

✓ *Simple to calculate* \Rightarrow outlines with $\theta = \text{cste}$ or $\varphi = \text{cste}$

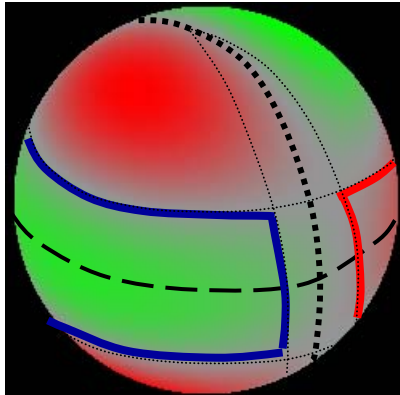

$m = 1$

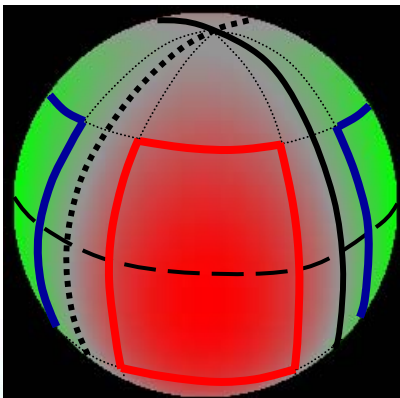

$m = 2$

Sph. Harm. : antisymmetrical Y_{nm}

$n = 1$

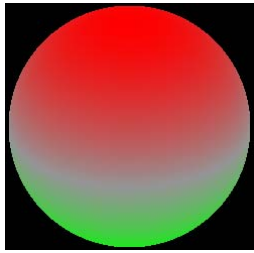

$n = 2$

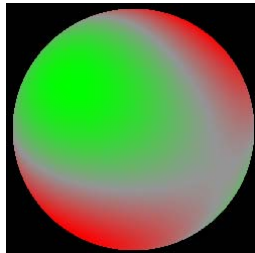

$n = 3$

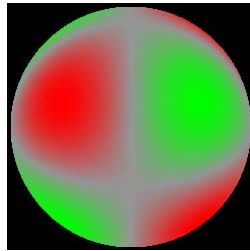
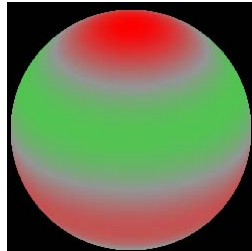

$n = 4$

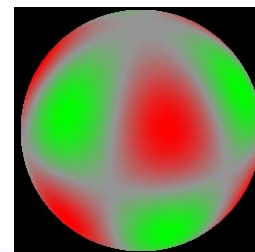
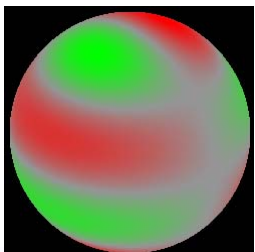

Sensors nm:

- ✓ Antisymm. / $z=0$
- ✓ $2m$ -antiperiodic

No signal for :

- ✓ symm. $Y_{m'n'}$



$m = 0$



2

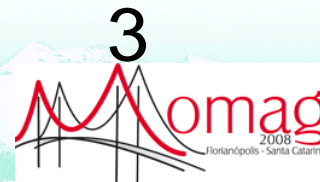

4

Symm. sensors nm:

- ✓ symmetric / $z=0$
- ✓ $2m$ -antiperiodic

✓ *Simple to calculate* \Rightarrow outlines with $\theta = \text{cste}$ or $\varphi = \text{cste}$

Antisymm. sensors nm:

- ✓ antisymmetric / $z=0$
- ✓ $2m$ -antiperiodic

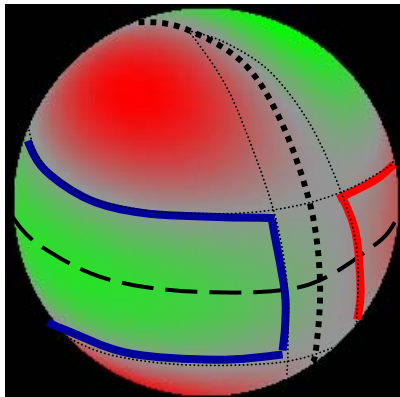

$m = 1$

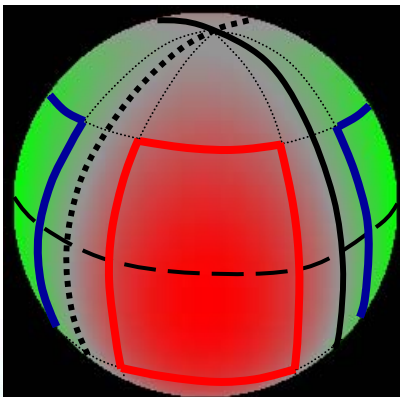
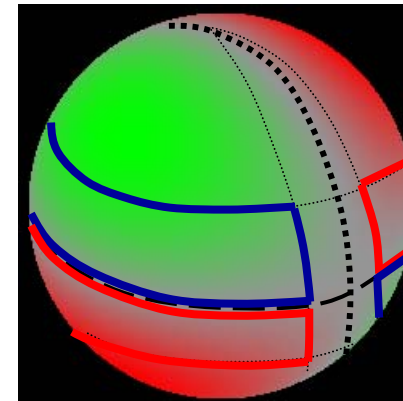

$m = 2$

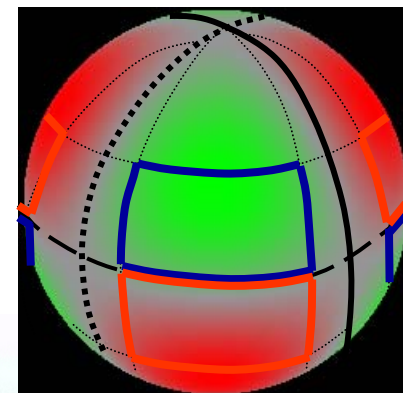

Flux of $B(Y_{n'm'})$ in the sensor S_{nm}

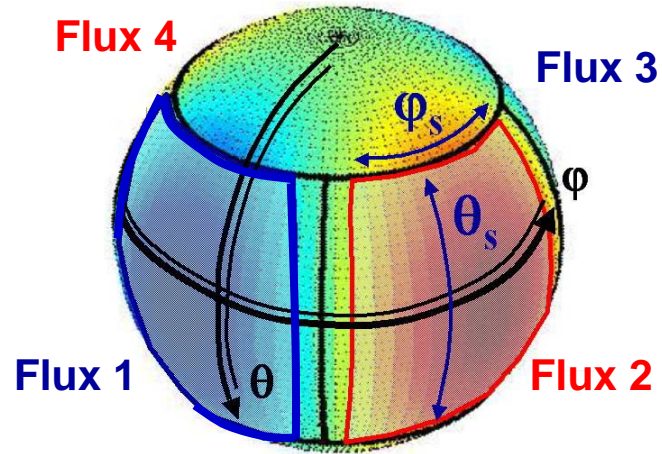

Flux of $B(Y_{n',m'})$ in the sensor S_{nm}

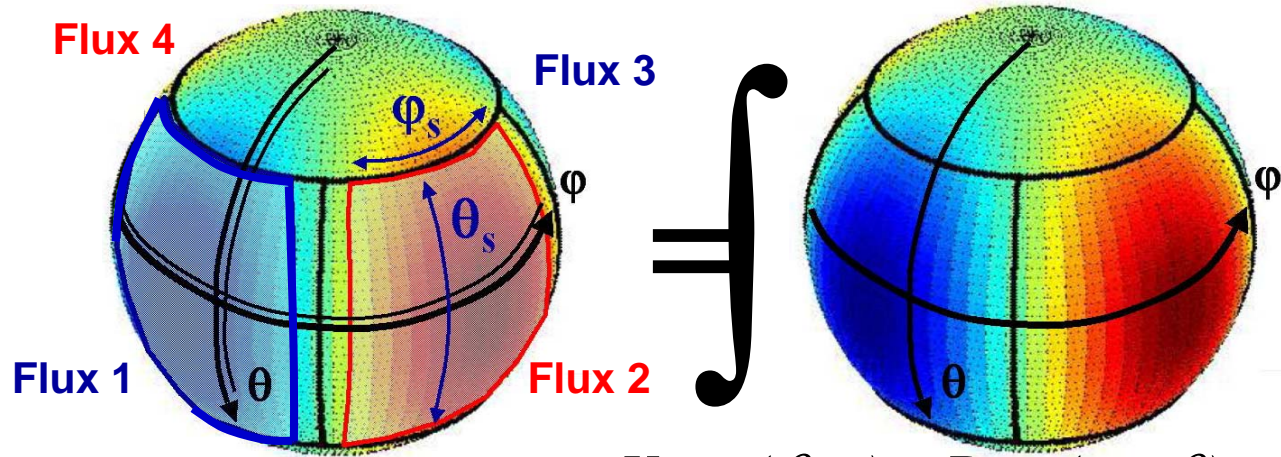

$$Y_{n',m'}(\theta, \varphi) = P_{n',m'}(\cos \theta) \cdot \cos(m' \varphi)$$

Flux of $B(Y_{n,m'})$ in the sensor S_{nm}

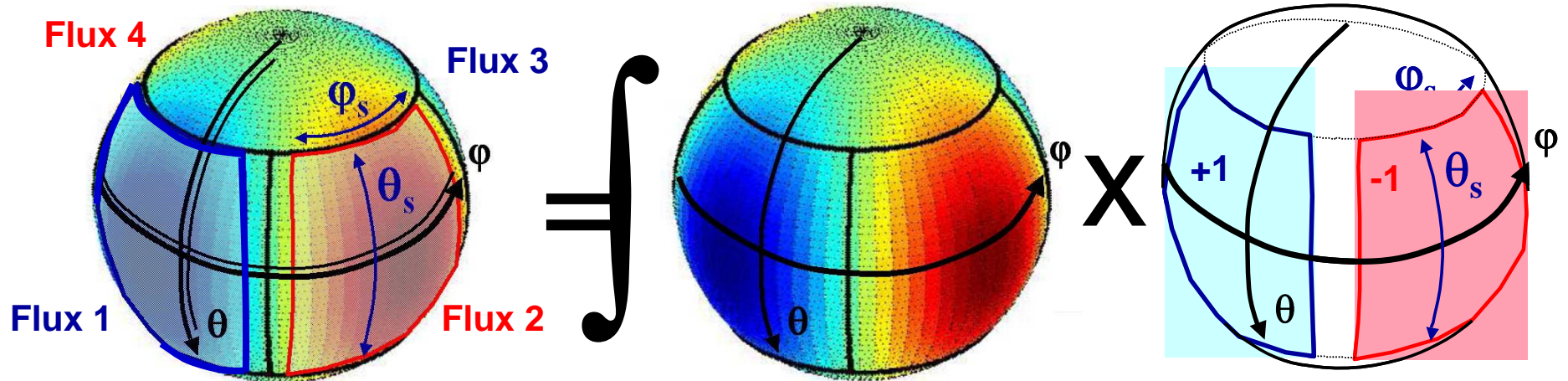

$$Y_{n,m'}(\theta, \varphi) = P_{n,m'}(\cos \theta) \cdot \cos(m' \varphi)$$

Flux of $B(Y_{n,m'})$ in the sensor S_{nm}

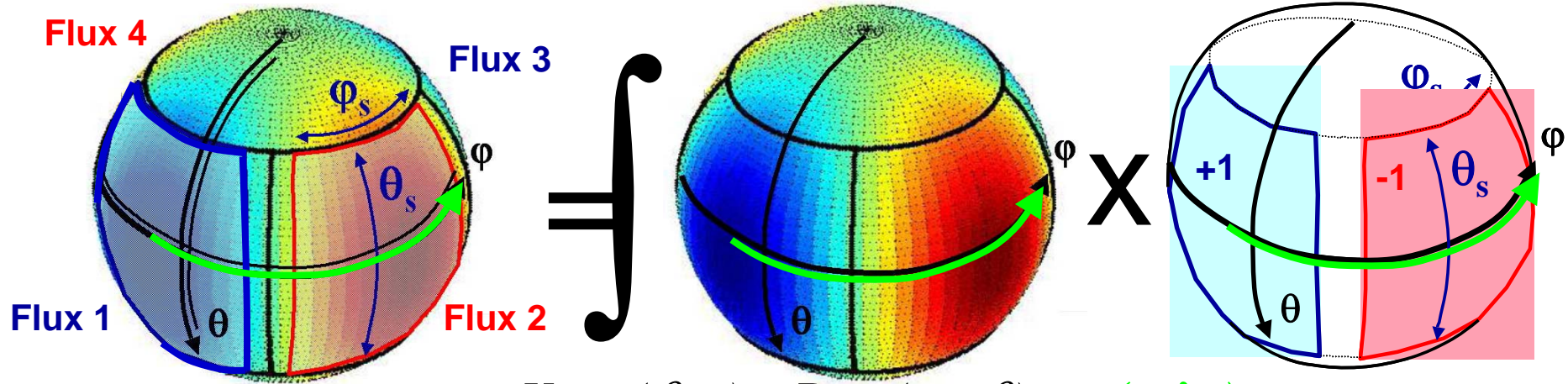

$$Y_{n,m'}(\theta, \varphi) = P_{n,m'}(\cos \theta) \cdot \cos(m' \varphi)$$

Flux of $B(Y_{n'm'})$ in the sensor S_{nm}

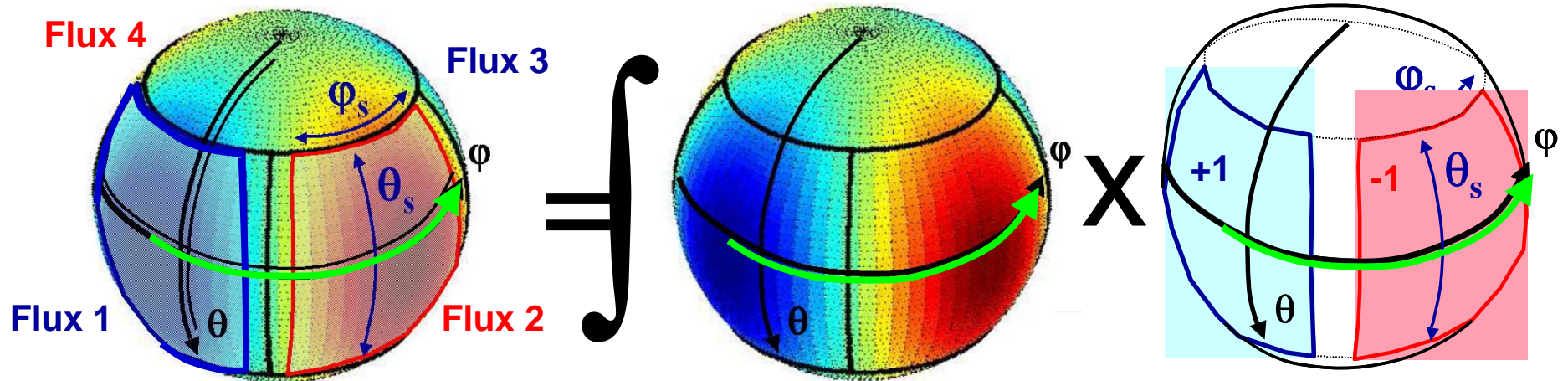

$$Y_{n'm'}(\theta, \phi) = P_{n'm'}(\cos\theta) \cdot \cos(m'\phi)$$

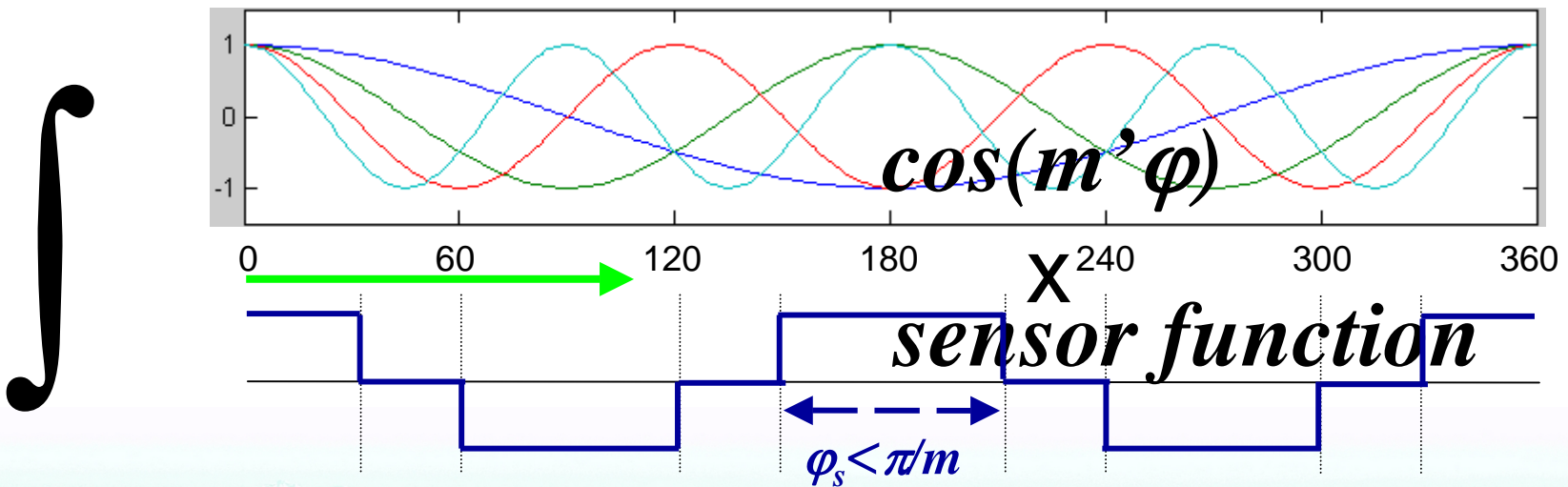

Flux of $B(Y_{n'm'})$ in the sensor S_{nm}

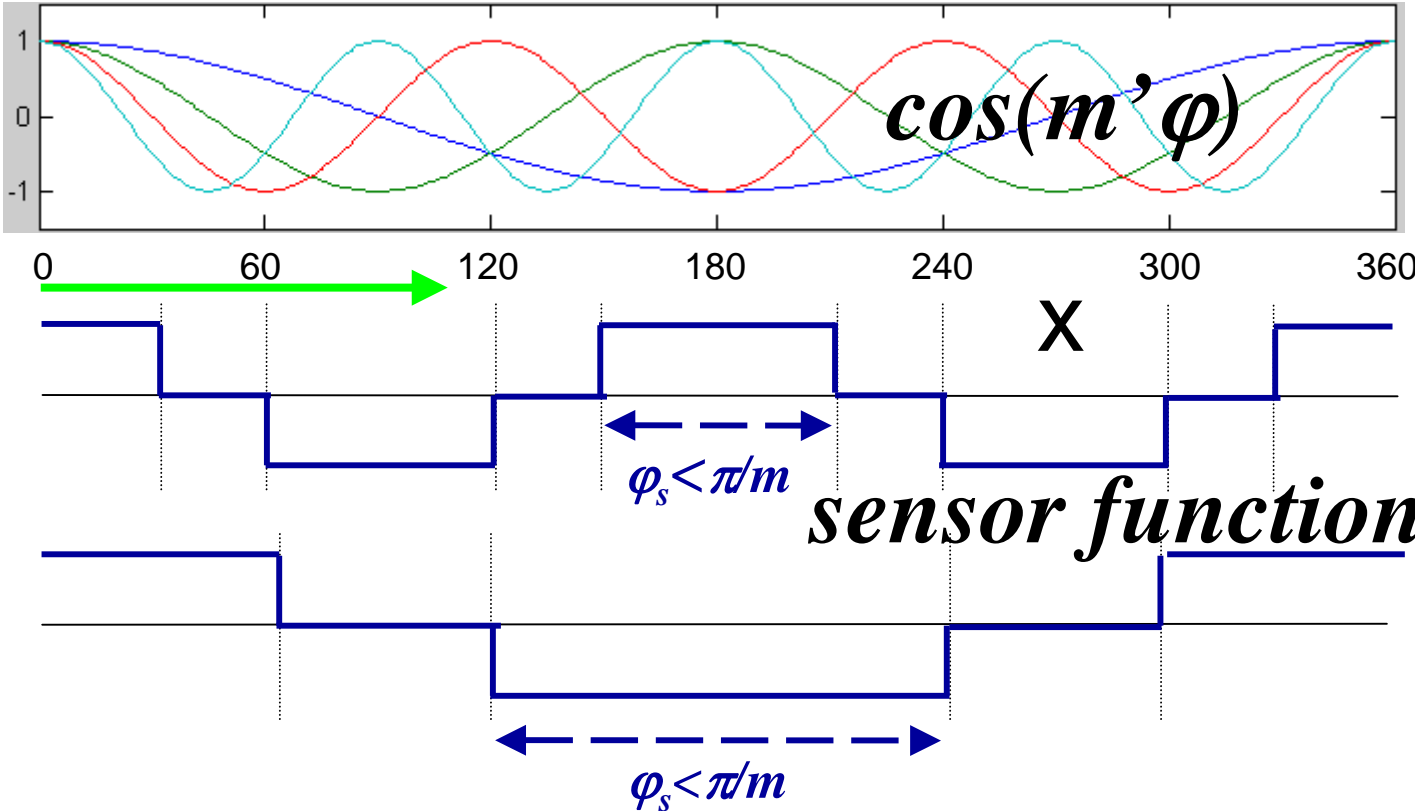
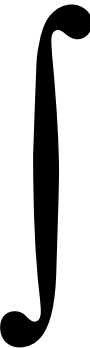

$m' =$
 1 2 3 4
 (source)

$m=2$
 (sensor)

$m=1$
 (sensor)

Flux of $B(Y_{n'm'})$ in the sensor S_{nm}

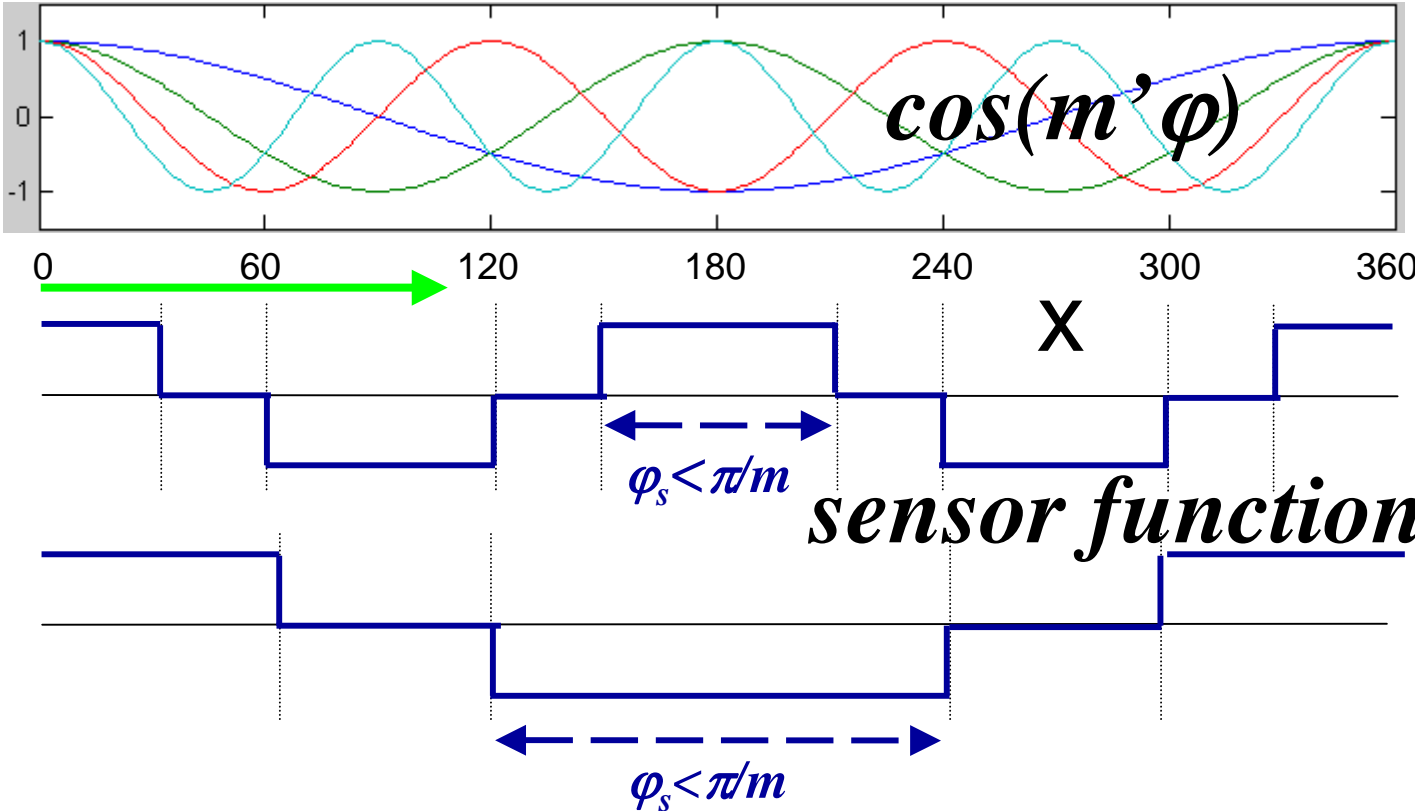
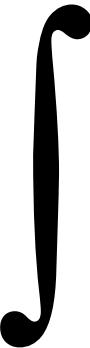

$m' =$
 1 2 3 4
 (source)

$m=2$
 (sensor)

$m=1$
 (sensor)

⇒ coeff. of the Fourier series of the “sensor function” :

Flux of $B(Y_{n'm'})$ in the sensor S_{nm}

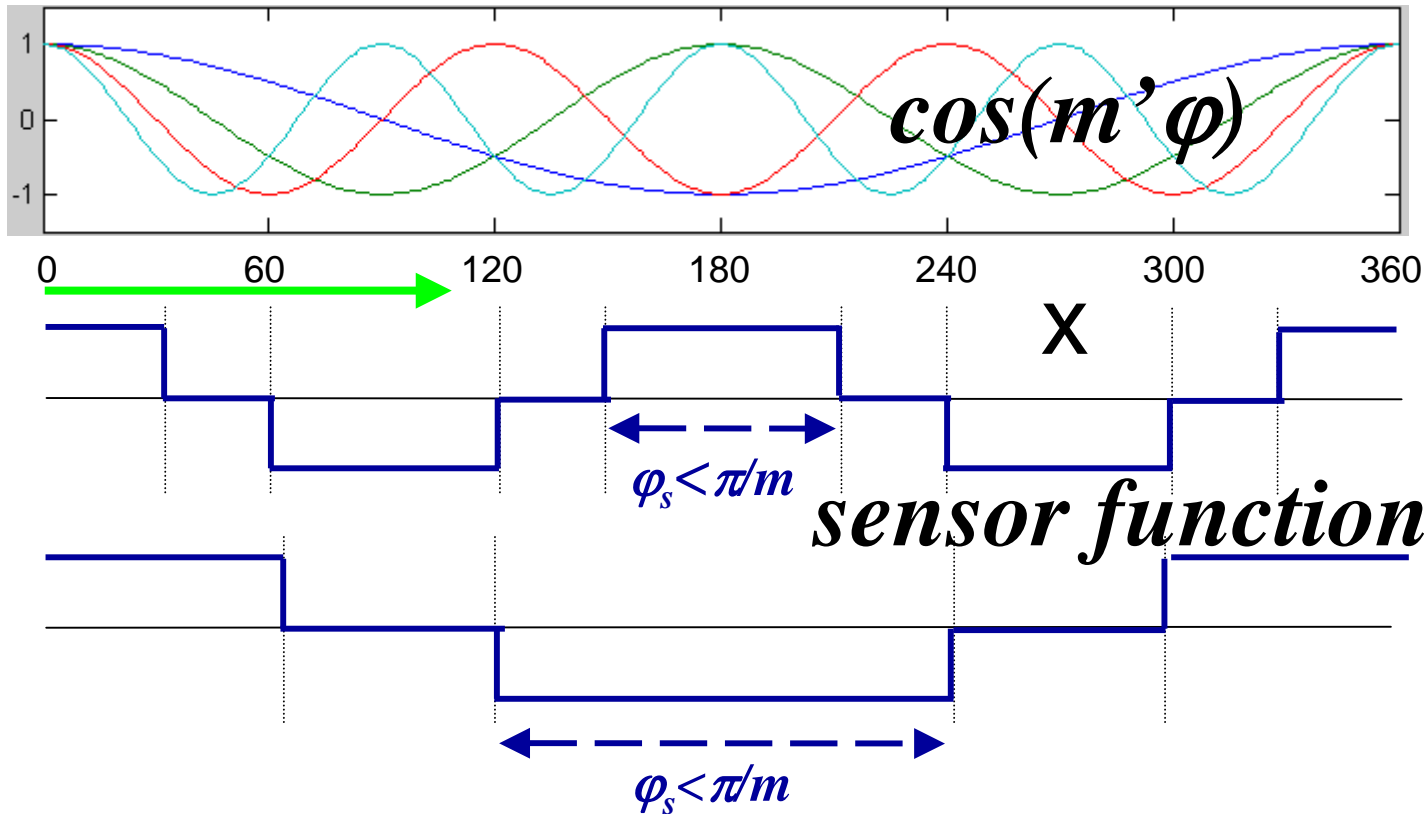
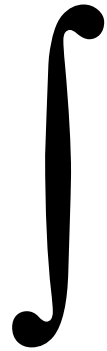

$m' =$
1 2 3 4
 (source)

$m=2$
 (sensor)

$m=1$
 (sensor)

⇒ coeff. of the Fourier series of the “sensor function” :

$\forall \varphi_s$: zero for : $\forall m' < m$ $m=0$: $\forall m' > 0$ $m=1$: $m' = 2, 4, 6, \dots$ $m=2$: $m' = 3, 4, 5, 7, 8, 9, \dots$



Flux of $B(Y_{n'm'})$ in the sensor S_{nm}

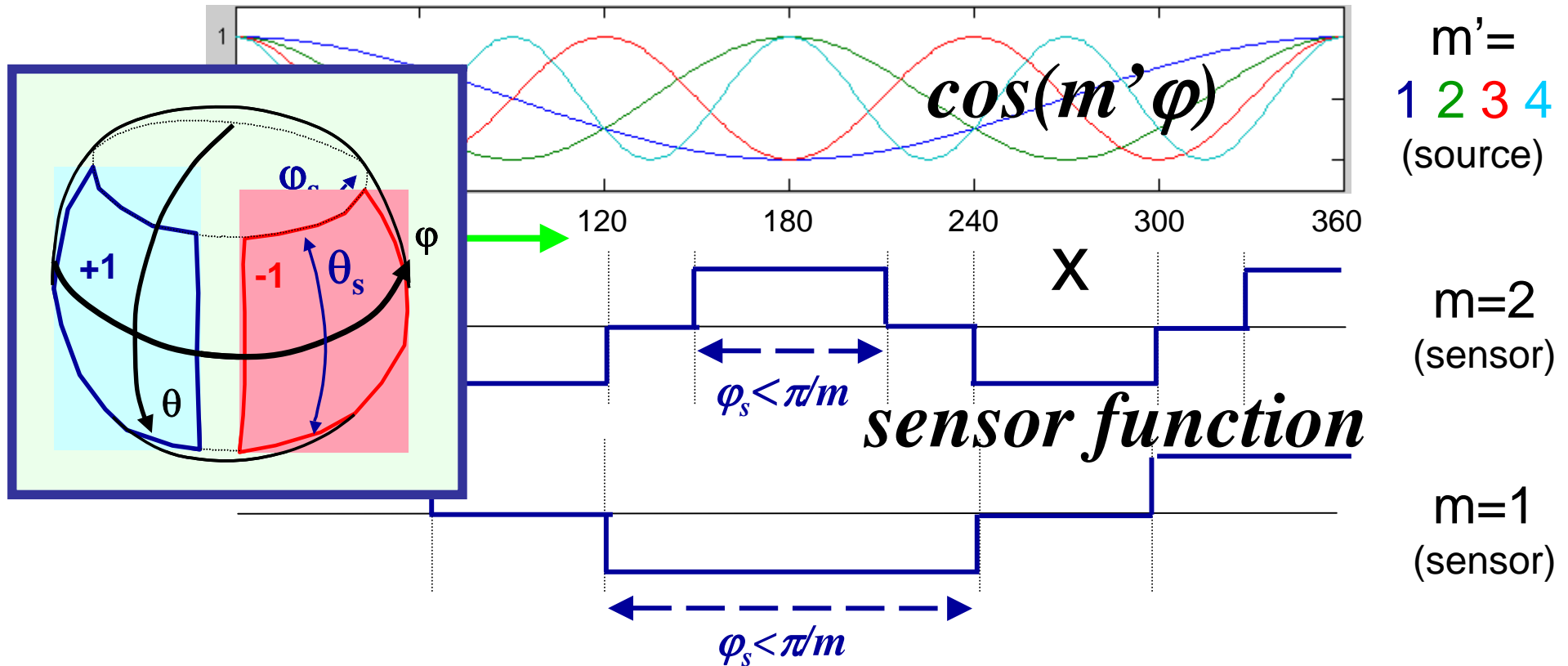

⇒ coeff. of the Fourier series of the “sensor function” :

$\forall \varphi_s$: zero for : $\forall m' < m$ $m=0$: $\forall m' > 0$ $m=1$: $m'=2,4,6\dots$ $m=2$: $m'=3,4,5,7,8,9,\dots$

Flux of $B(Y_{n'm'})$ in the sensor S_{nm}

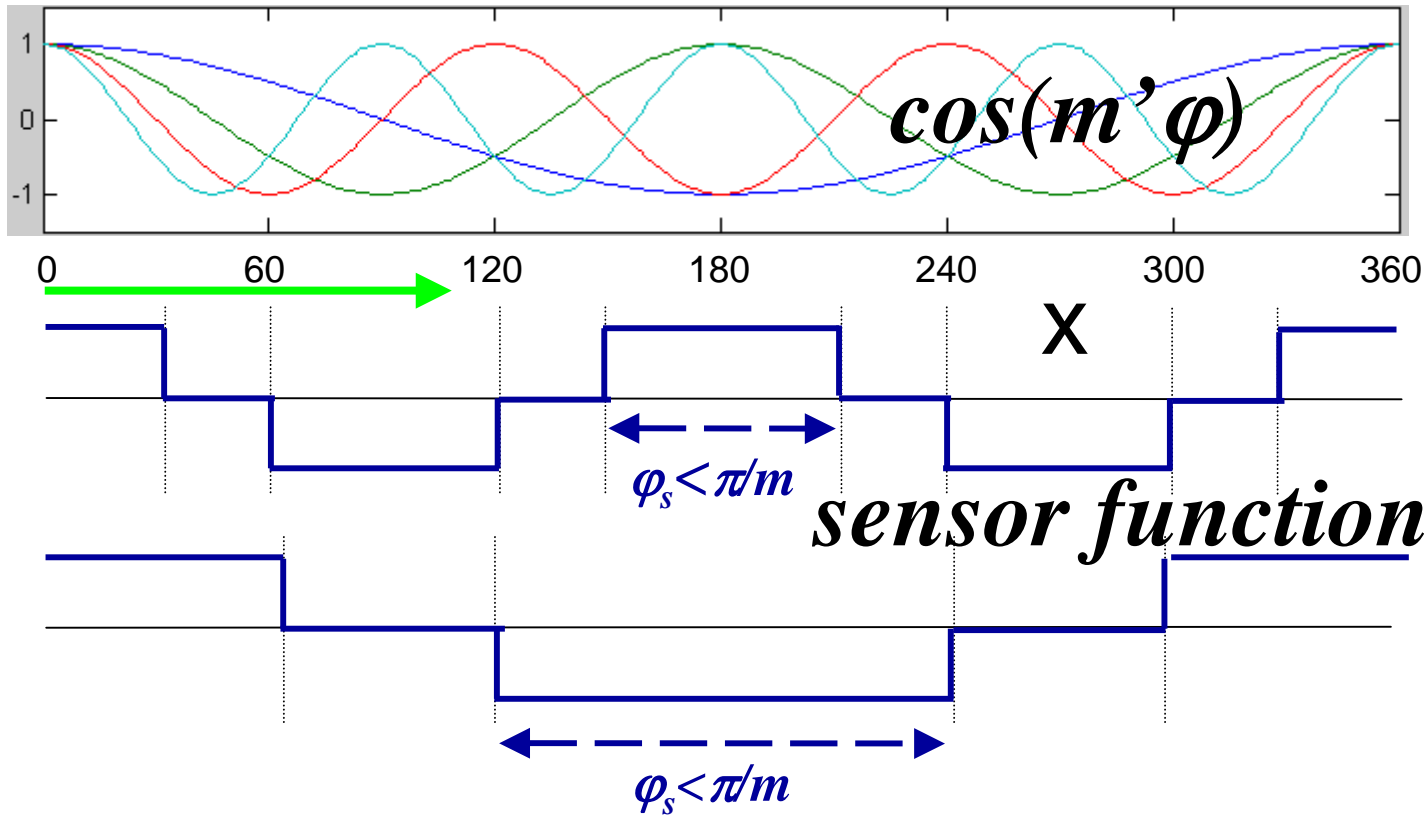
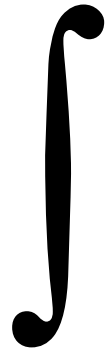

$m' =$
1 2 3 4
(source)

$m=2$
(sensor)

$m=1$
(sensor)

⇒ coeff. of the Fourier series of the “sensor function” :

$\forall \varphi_s$: zero for : $\forall m' < m$ $m=0$: $\forall m' > 0$ $m=1$: $m'=2,4,6\dots$ $m=2$: $m'=3,4,5,7,8,9,\dots$

$\varphi_s = 2\pi/3$ also zero for : $m=1$ and $m'=3,6,9\dots$

Symmetrical sensor S_{20} ($m=0$)

$n=1 :$	$Y_{1,0}$	$Y_{1,1}$			
$n=2 :$	$Y_{2,0}$	$Y_{2,1}$	$Y_{2,2}$		
$n=3 :$	$Y_{3,0}$	$Y_{3,1}$	$Y_{3,2}$	$Y_{3,3}$	
$n=4 :$	$Y_{4,0}$	$Y_{4,1}$	$Y_{4,2}$	$Y_{4,3}$	$Y_{4,4}$
$m' =$	0	1	2	3	4

zero for : $\forall m' < m$ $m=0: \forall m' > 0$ $m=1: m'=2,4,6\dots$ $m=2: m'=3,4,5,7,8,9,\dots$

Symmetrical sensor S_{20} ($m=0$)

$n=1$: $Y_{1,0}$

$n=2$: $Y_{2,0}$

$n=3$: $Y_{3,0}$

$n=4$: $Y_{4,0}$

$m' =$ 0 1 2 3 4



zero for : $\forall m' < m$

$m=0: \forall m' > 0$

$m=1: m'=2,4,6\dots$

$m=2: m'=3,4,5,7,8,9,\dots$

Symmetrical sensor S_{20} ($m=0$)

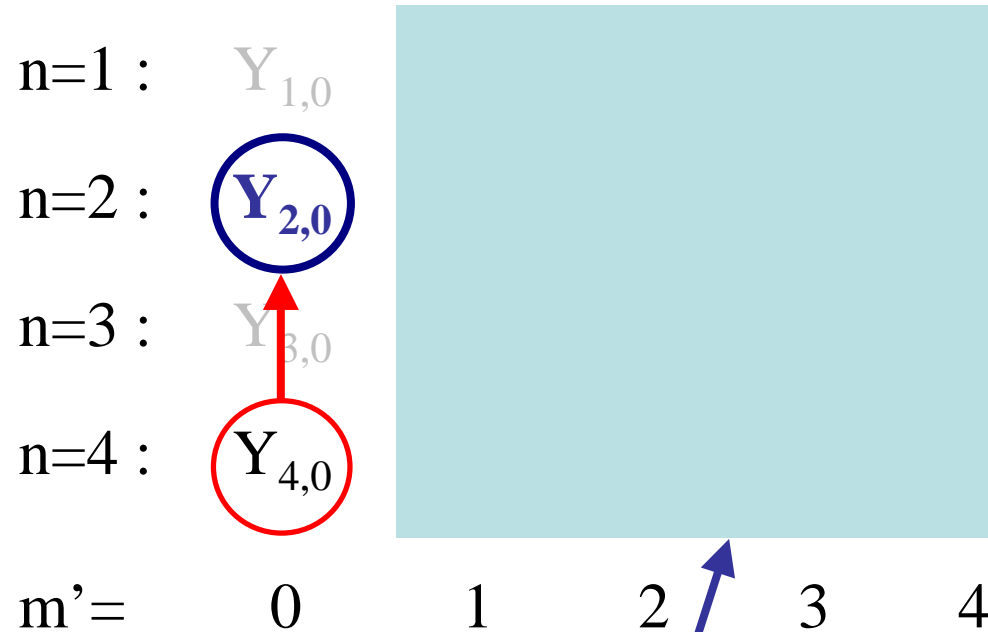

zero for : $\forall m' < m$

$m=0: \forall m' > 0$

$m=1: m'=2,4,6\dots$

$m=2: m'=3,4,5,7,8,9,\dots$

Symmetrical sensor S_{11} ($m=1$)

n=1 :	$Y_{1,0}$	$Y_{1,1}$			
n=2 :	$Y_{2,0}$	$Y_{2,1}$	$Y_{2,2}$		
n=3 :	$Y_{3,0}$	$Y_{3,1}$	$Y_{3,2}$	$Y_{3,3}$	
n=4 :	$Y_{4,0}$	$Y_{4,1}$	$Y_{4,2}$	$Y_{4,3}$	$Y_{4,4}$
m' =	0	1	2	3	4

zero for : $\forall m' < m$ $m=0: \forall m' > 0$ $m=1: m'=2,4,6\dots$ $m=2: m'=3,4,5,7,8,9,\dots$

Symmetrical sensor S_{11} ($m=1$)

n=1 :					$Y_{1,1}$		
n=2 :					$Y_{2,1}$	$Y_{2,2}$	
n=3 :					$Y_{3,1}$	$Y_{3,2}$	$Y_{3,3}$
n=4 :					$Y_{4,1}$	$Y_{4,2}$	$Y_{4,3}$
m' =	0	1	2	3	4		

zero for : $\forall m' < m$

$m=0: \forall m' > 0$

$m=1: m'=2,4,6\dots$

$m=2: m'=3,4,5,7,8,9,\dots$

Symmetrical sensor $S_{1,1}$ ($m=1$)

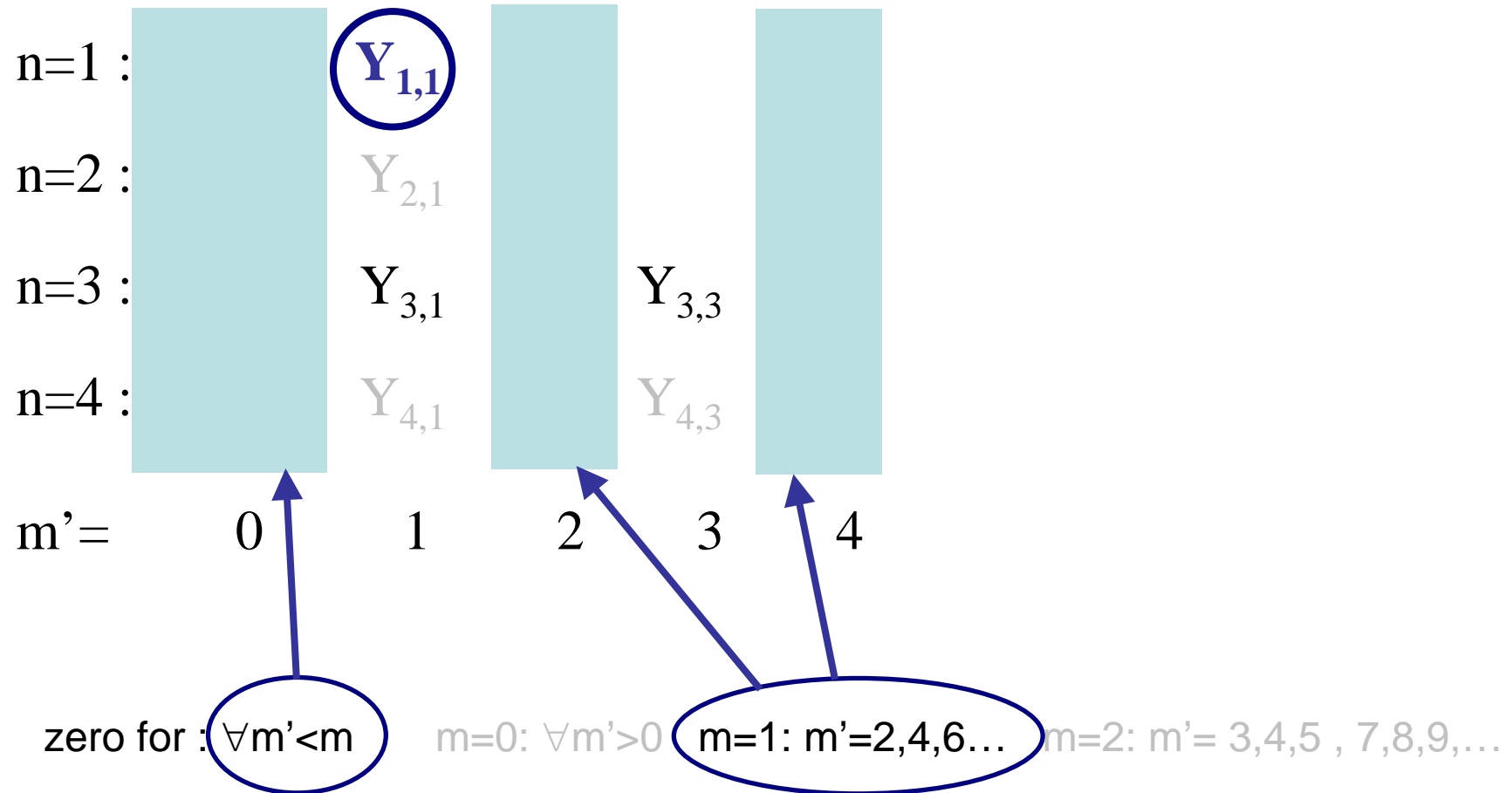

Symmetrical sensor $S_{1,1}$ ($m=1$)

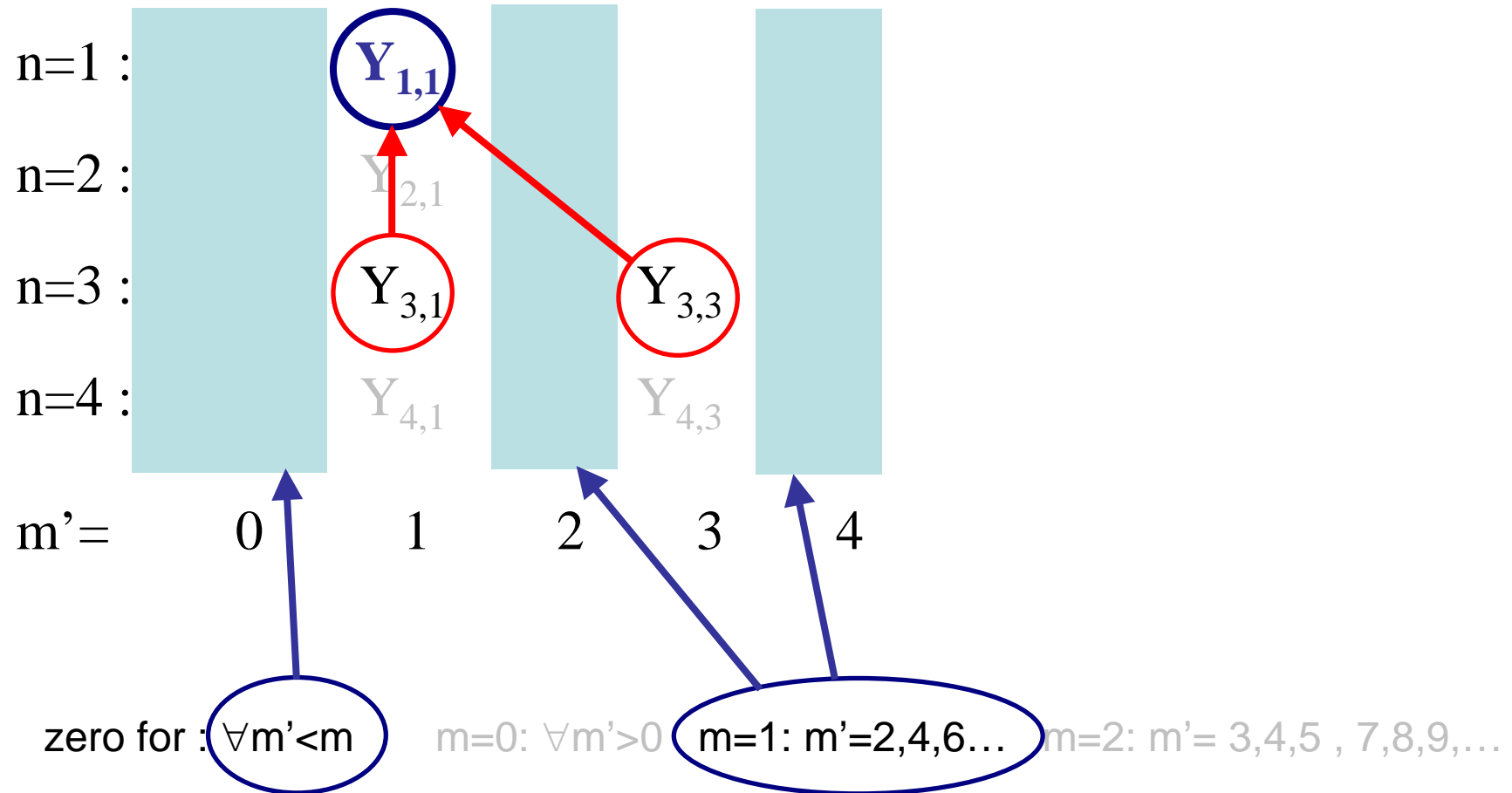

Symmetrical sensor S_{22} ($m=2$)

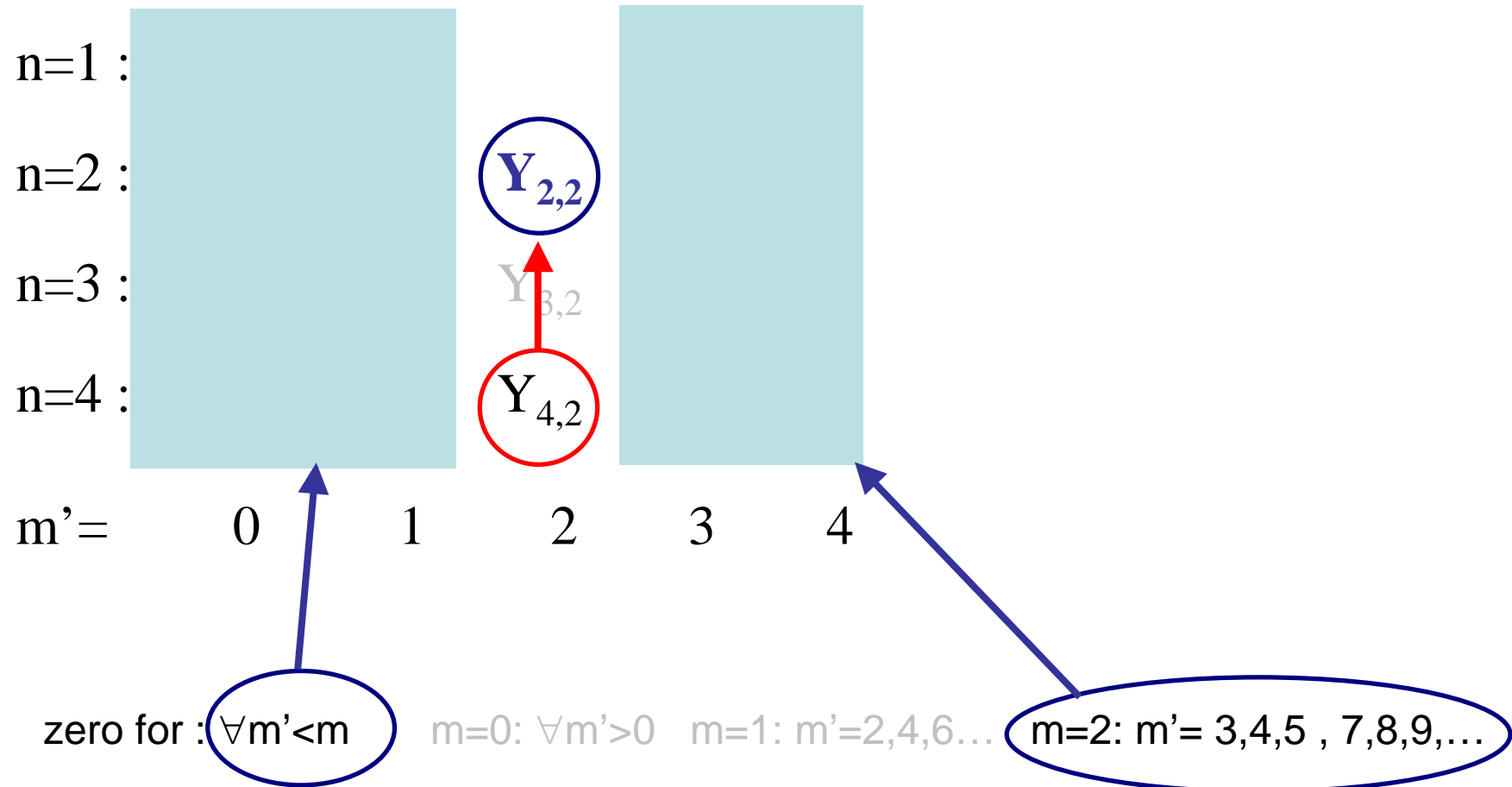

Symmetrical sensors

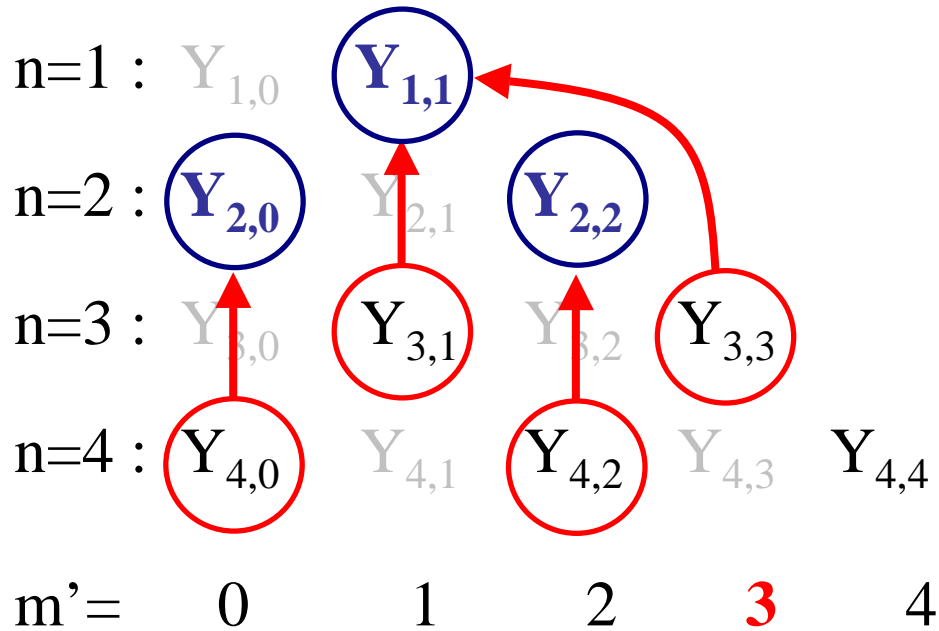

Unsymmetrical sensors

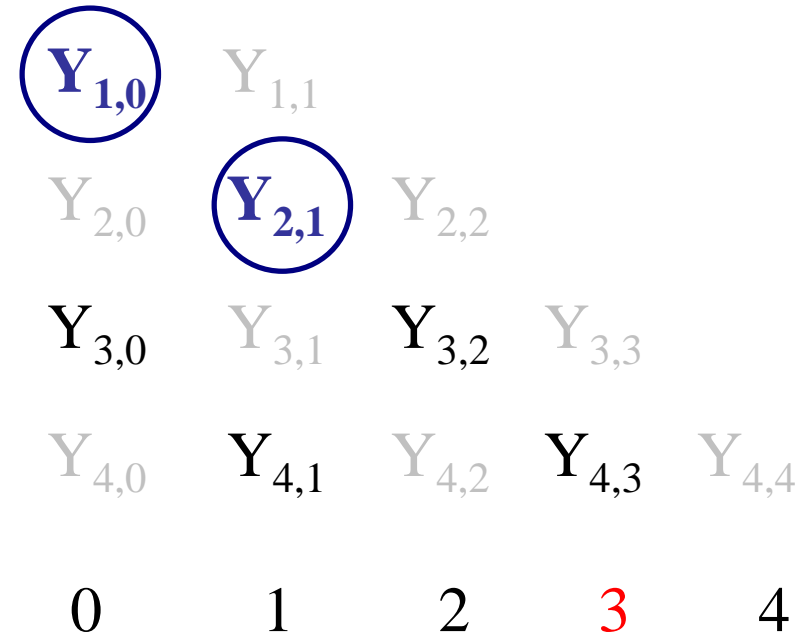

Symmetrical sensors

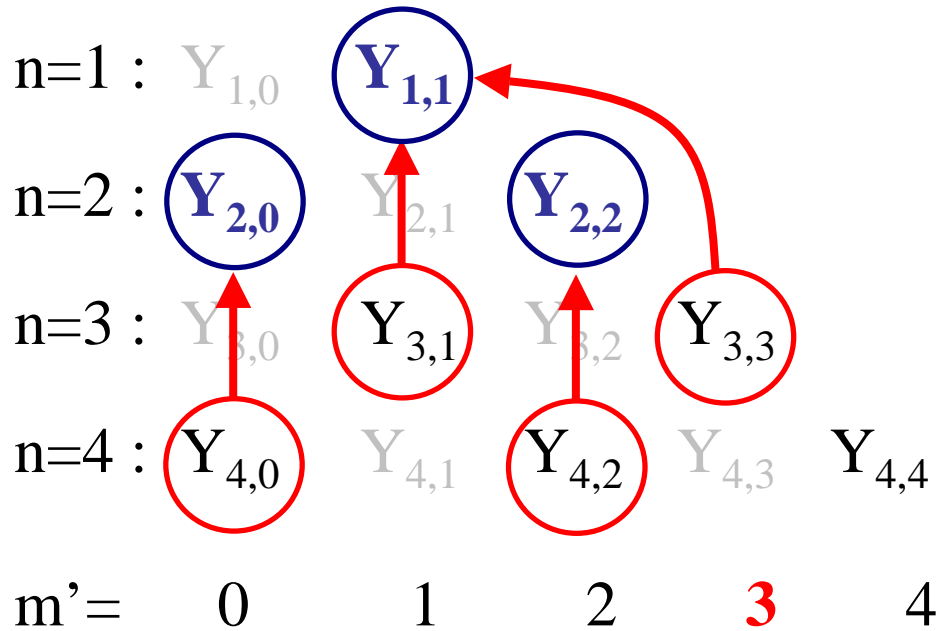

Unsymmetrical sensors

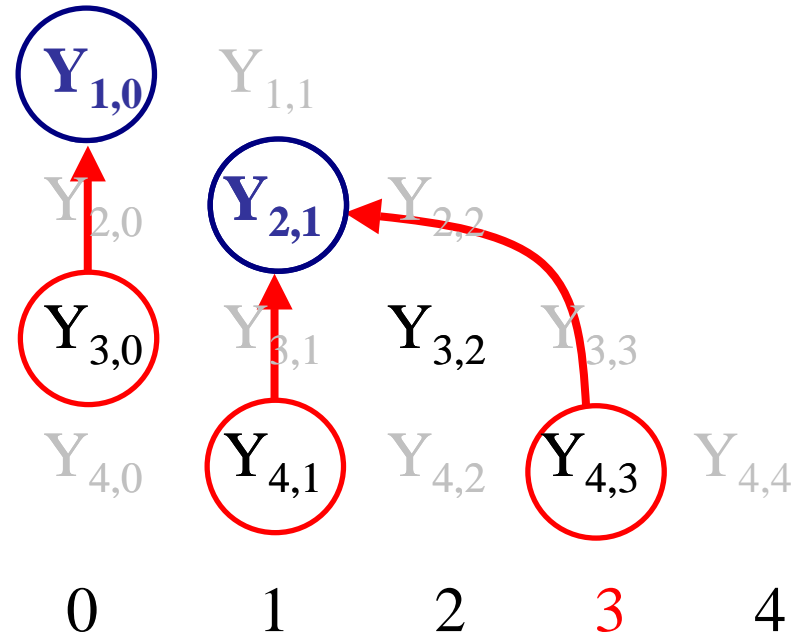

Symmetrical sensors

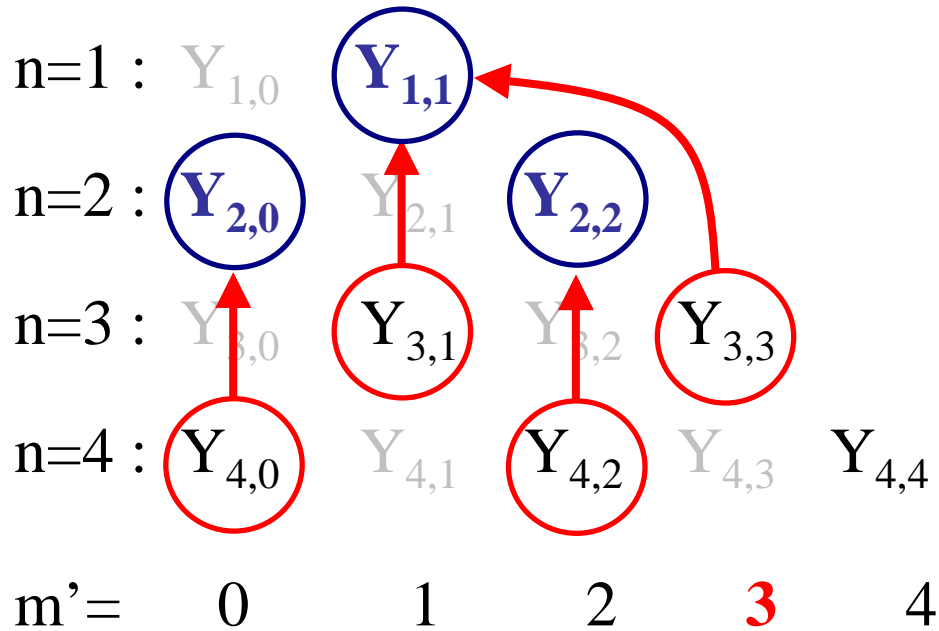

Unsymmetrical sensors

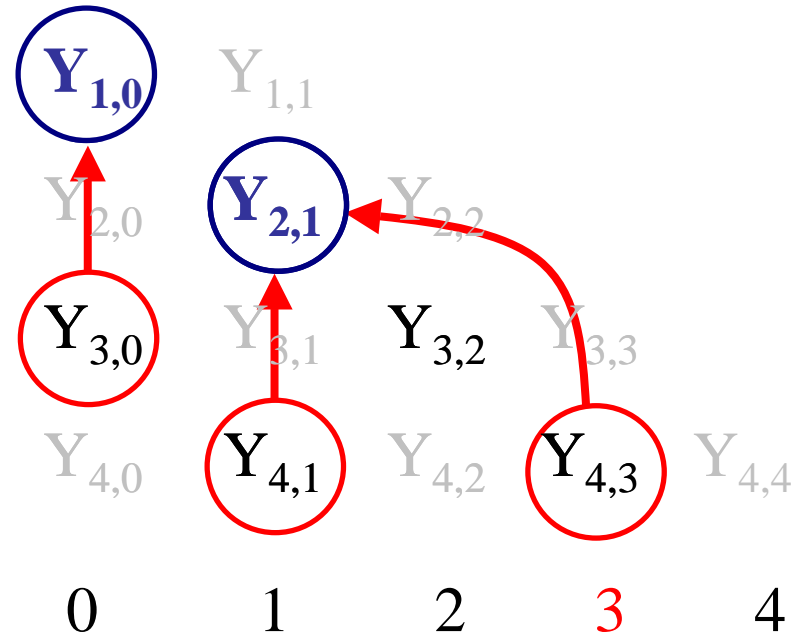

\Rightarrow zero for : $\varphi_s = 2\pi/3$ and $m=1$: $m'=3,6,9\dots$

Symmetrical sensors

Unsymmetrical sensors

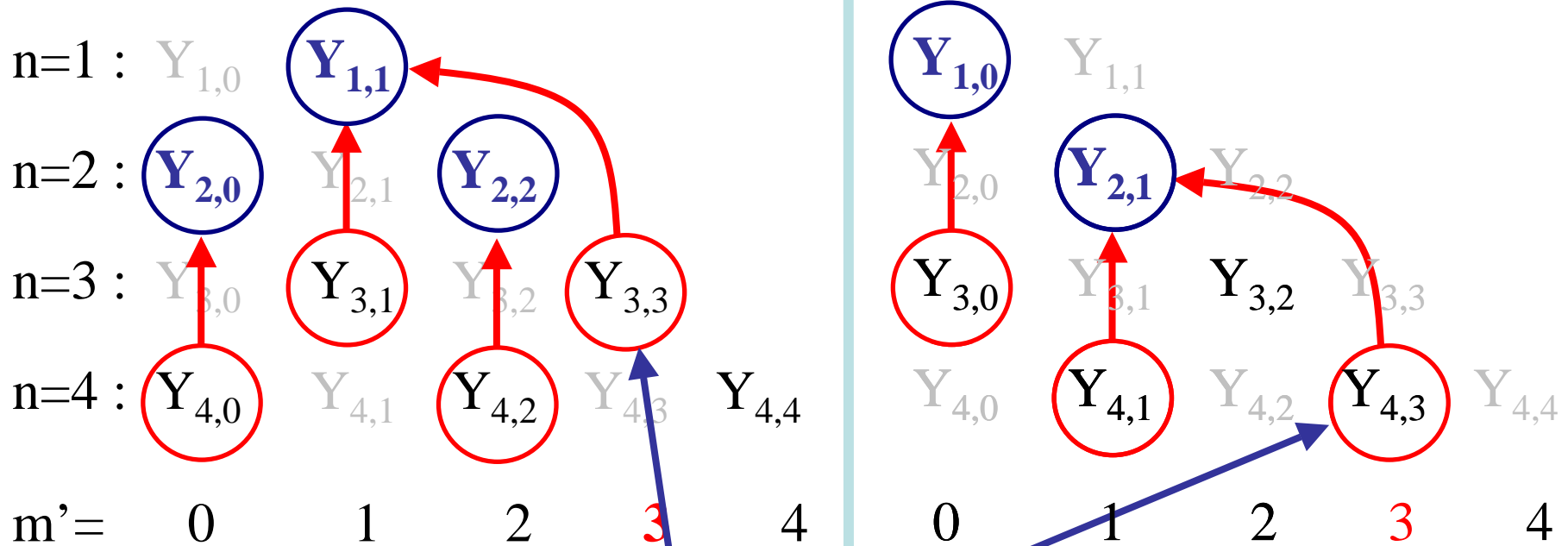

⇒ zero for :

$\varphi_s = 2\pi/3$ and $m=1$: $m'=3,6,9\dots$

Symmetrical sensors

Unsymmetrical sensors

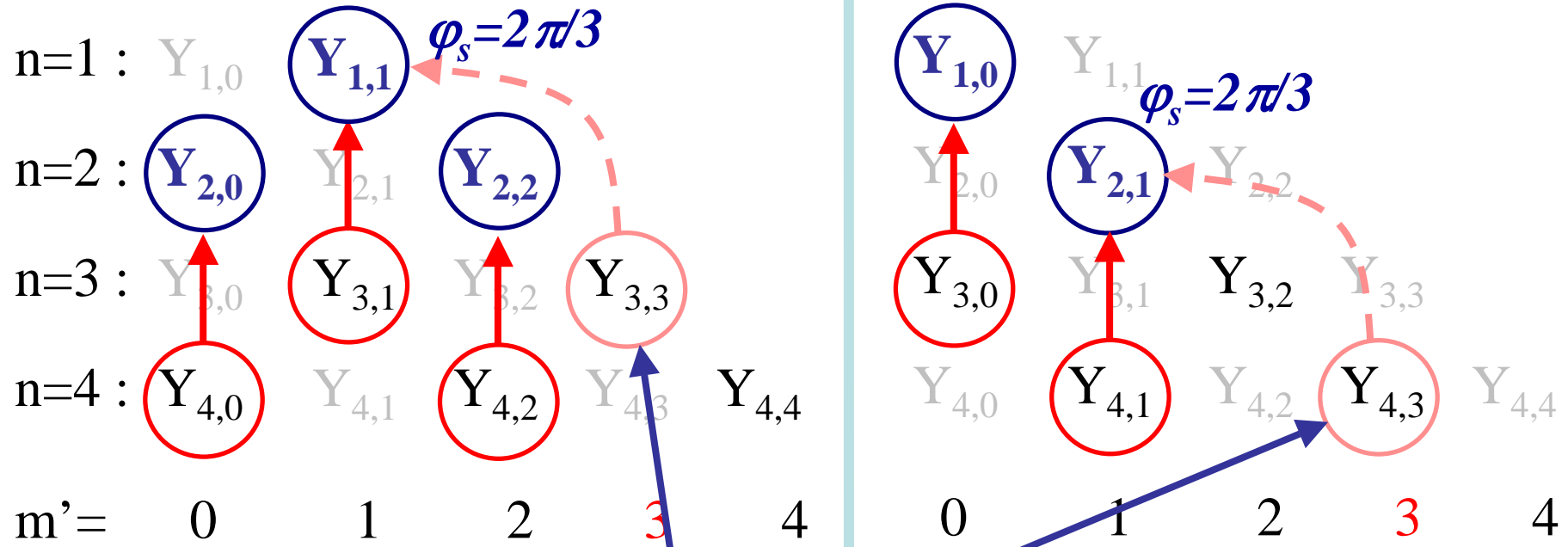

⇒ zero for :

$\varphi_s = 2\pi/3$ and $m=1: m'=3,6,9\dots$

Symmetrical sensors

Unsymmetrical sensors

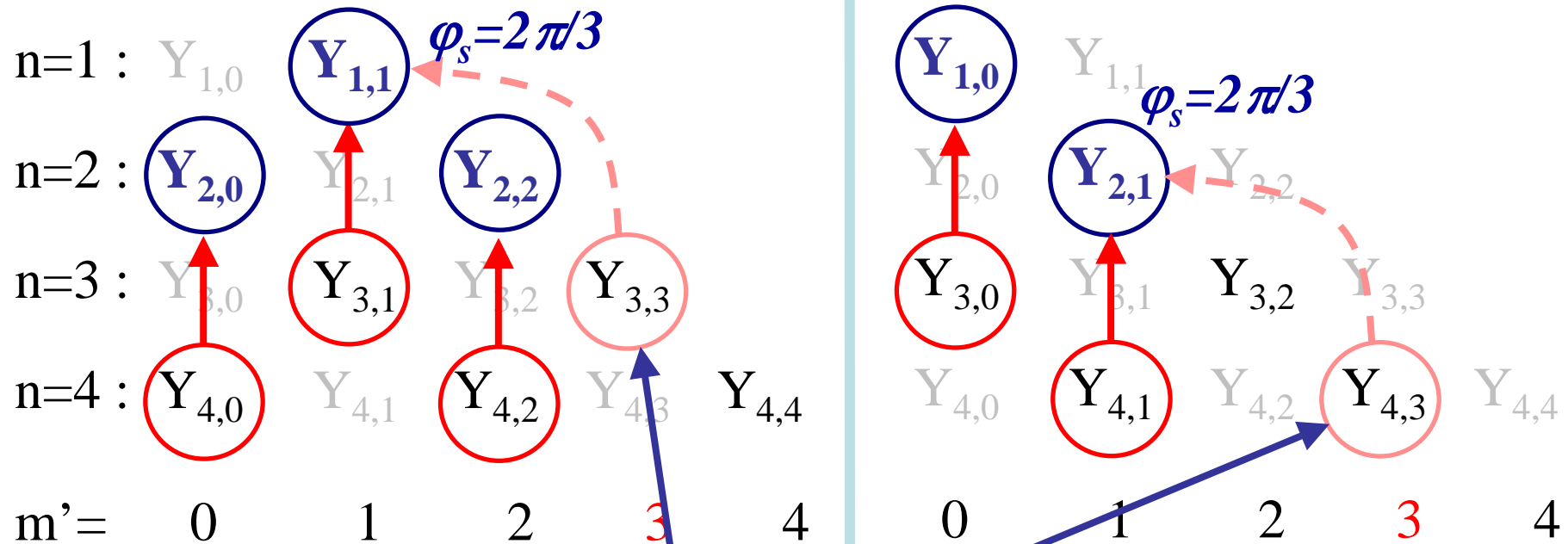

\Rightarrow zero for :

$\varphi_s = 2\pi/3$ and $m=1: m'=3,6,9\dots$

How to remove the last cross effects ?

Symmetrical sensors

Unsymmetrical sensors

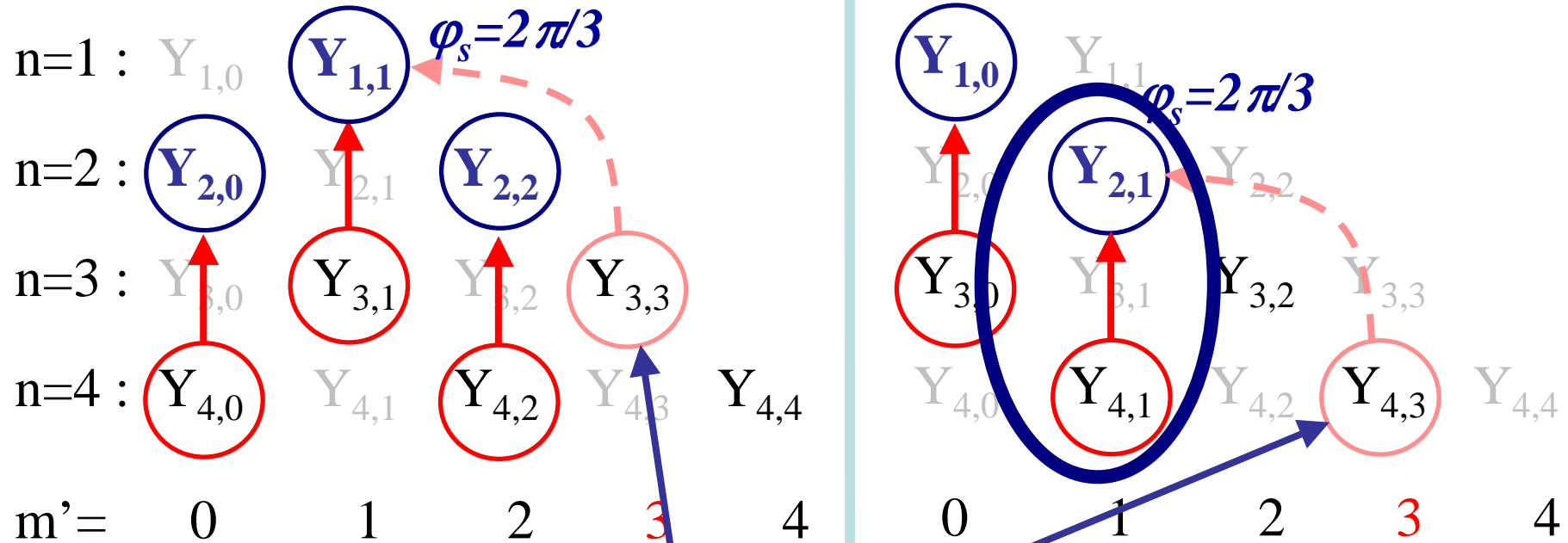

⇒ zero for :

$\varphi_s = 2\pi/3$ and $m=1: m'=3,6,9\dots$

How to remove the last cross effects ?

How to remove the cross effect ?

S_{21}

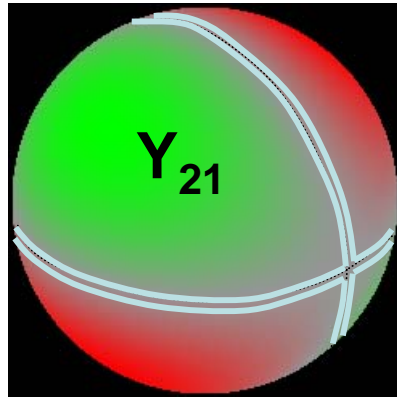

Max for Y_{21}
but ...

Y_{41} : not zero

Y_{43} : not zero

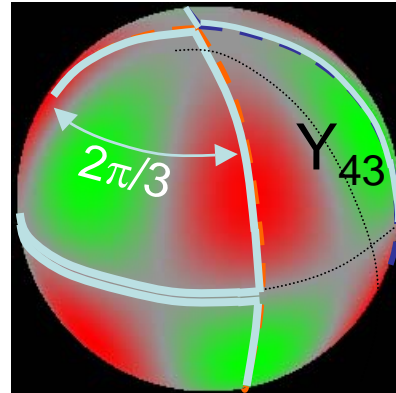

Y_{41} : not zero

Y_{43} : **zero**

Y_{43} : sensitive to the “width” φ_s of the coil

How to remove the cross effect ?

S_{21}

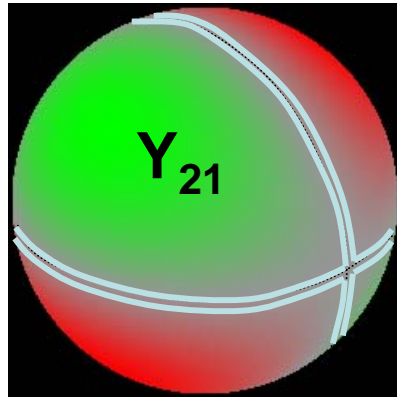

Max for Y_{21}
but ...

Y_{41} : not zero

Y_{43} : not zero

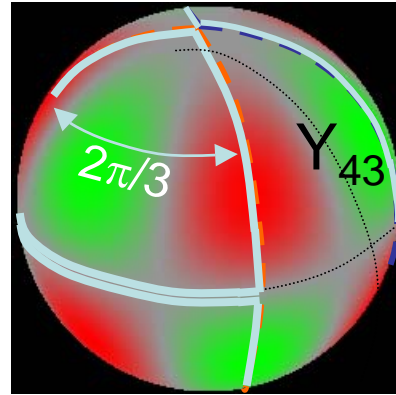

Y_{41} : not zero

Y_{43} : zero

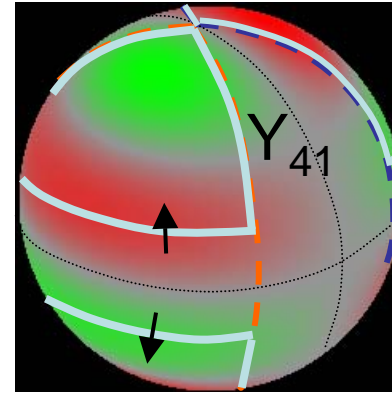

Y_{41} : zero

Y_{43} : zero

Y_{43} : sensitive to the “width” φ_s of the coil

Y_{41} : sensitive to the “high” of the coil

How to remove the cross effects ?

- by adjusting the high of the sensor $\downarrow \uparrow$

S_{10}

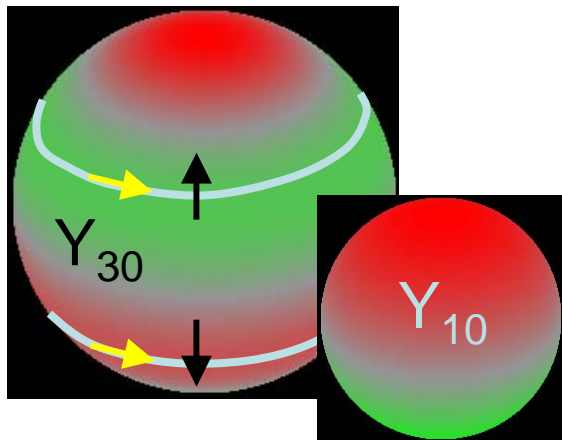

$S_{11} (S_{1,-1})$

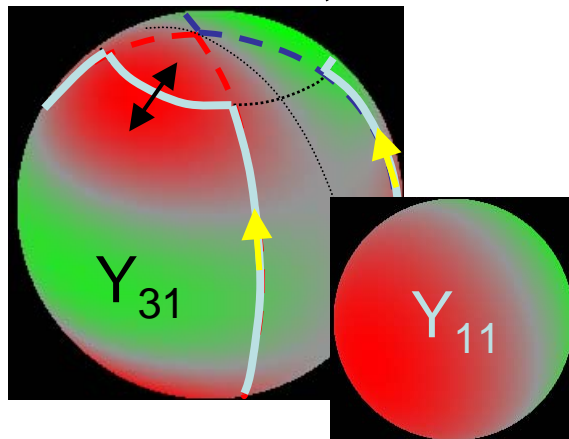

S_{20}

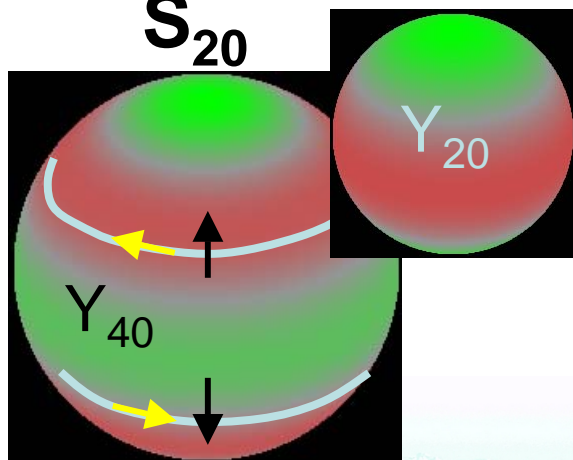

$S_{21} (S_{2,-1})$

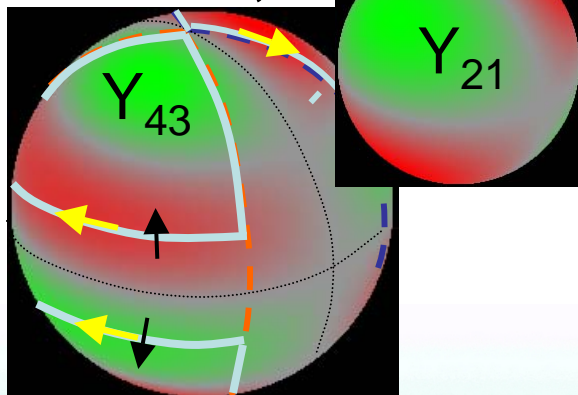

$S_{22} (S_{2,-2})$

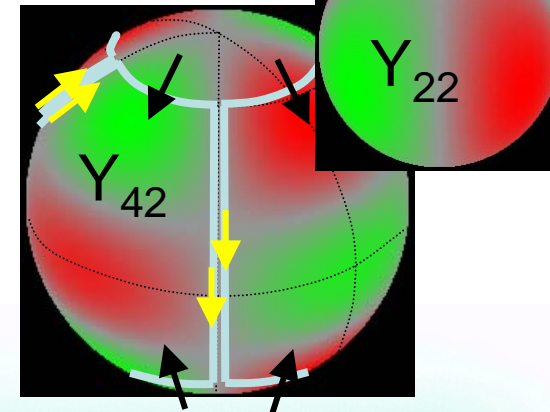

How to remove the cross effects ?

- by adjusting the high of the sensor $\downarrow \uparrow$

S_{10}

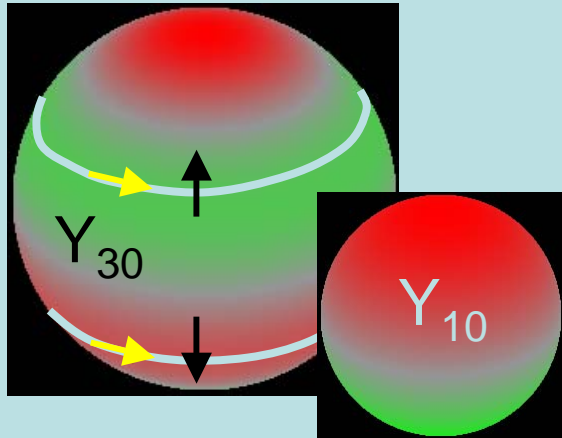

$S_{11} (S_{1,-1})$

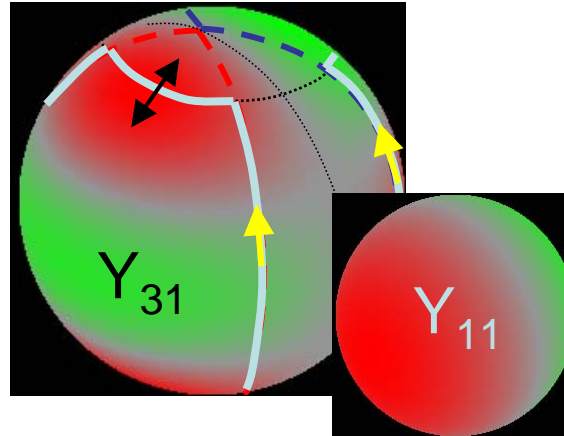

The standard sensor for Y_{10} gives a signal to sources $\geq 3d$ order

these sensors :
 $\geq 5th$ order

S_{20}

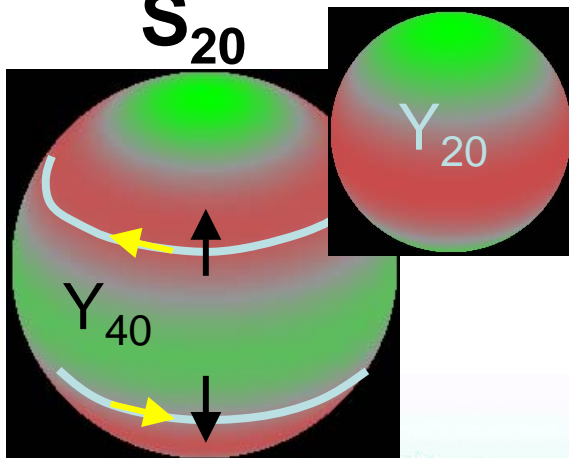

$S_{21} (S_{2,-1})$

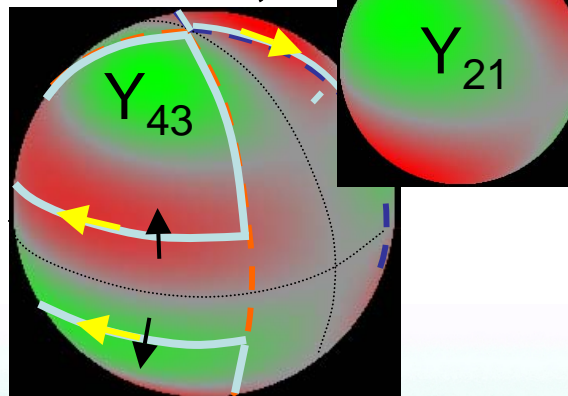

$S_{22} (S_{2,-2})$

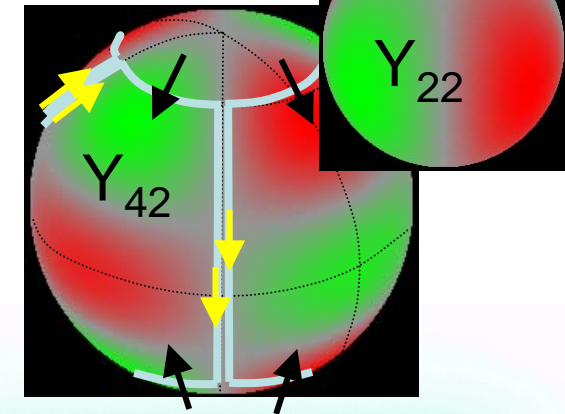

Sensor S21 :

a more simple and rigorous solution

S₂₁

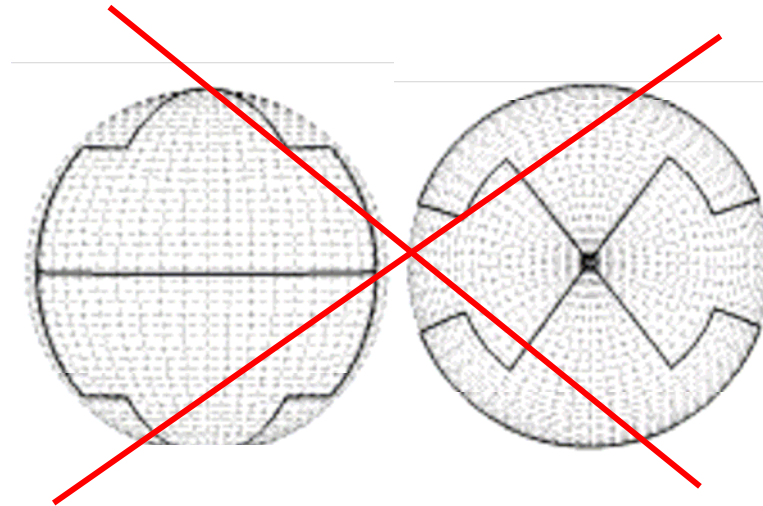
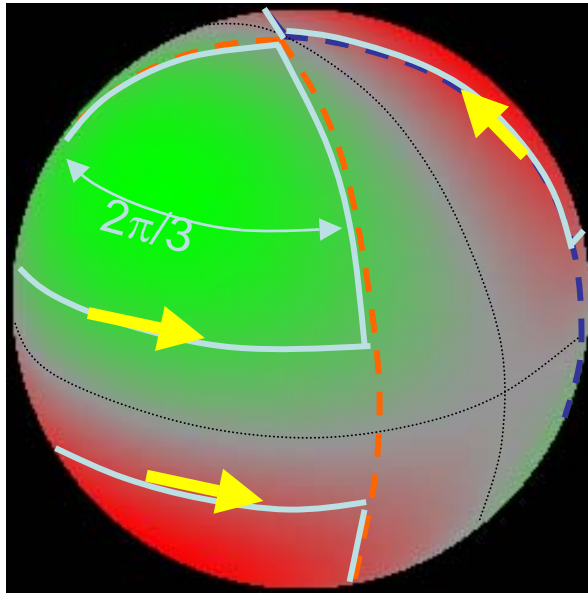

CEFC
2008

Sensor S₂₁ :

a more simple and rigorous solution

S₂₁

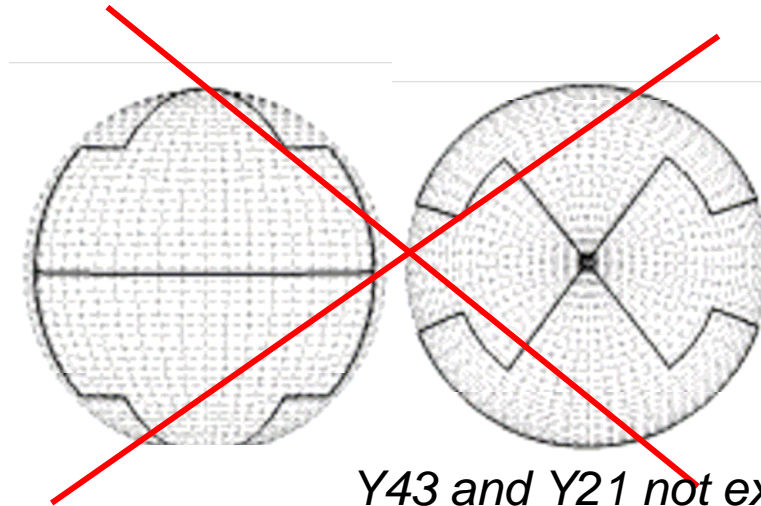
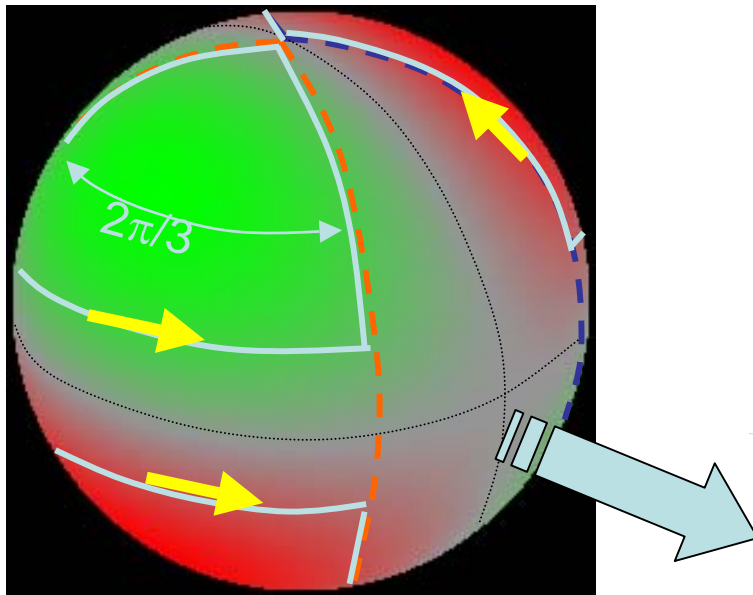

CEFC
2008

Y43 and Y21 not exactly filtered

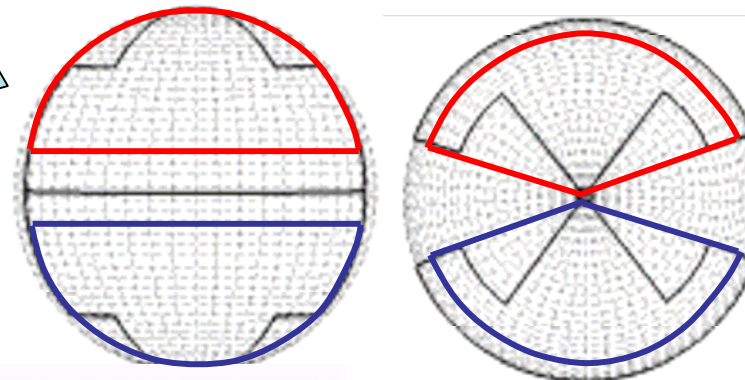

MOMAG
2008

Conclusion : a new sensor concept



Conclusion : a new sensor concept

- Design of 5 sensor shapes for the identification of 3 dipolar and 5 quadripolar coefficients
 - without cross-effects
 - field perturbations : only terms in $1/r^7$ or smaller ...



Conclusion : a new sensor concept

- Design of 5 sensor shapes for the identification of 3 dipolar and 5 quadripolar coefficients
 - without cross-effects
 - field perturbations : only terms in $1/r^7$ or smaller ...
- Use of all properties of symmetry and periodicity of the spherical harmonics



Conclusion : a new sensor concept

- Design of 5 sensor shapes for the identification of 3 dipolar and 5 quadripolar coefficients
 - without cross-effects
 - field perturbations : only terms in $1/r^7$ or smaller ...
- Use of all properties of symmetry and periodicity of the spherical harmonics
- Better than the standard sensor
 - more robust (*sensitivity to the position of the center of the sensors*)
 - but more complex and only “virtual” (!)



Conclusion : a new sensor concept

- Design of 5 sensor shapes for the identification of 3 dipolar and 5 quadripolar coefficients
 - without cross-effects
 - field perturbations : only terms in $1/r^7$ or smaller ...
- Use of all properties of symmetry and periodicity of the spherical harmonics
- Better than the standard sensor
 - more robust (*sensitivity to the position of the center of the sensors*)
 - but more complex and only “virtual” (!)
- *My feeling : possible with **only 3** different sensor shapes*

