

**This document must be cited according to its final version
which is published in a conference proceeding as:
M.C. Larabi, P. Dufour, P. Laurent, Y. Touré,
"Predictive control of a nonlinear distributed parameter system:
Real time control of a painting film drying process",
Proceedings of the 14th Mathematical Theory on Network and Systems
(MTNS),
Paper B167,
Perpignan, France, june 19-23, 2000.**

**All open archive documents of Pascal Dufour are available:
http://hal.archives-ouvertes.fr/DUFOUR_PASCAL_C-3926-2008**

**The list of Pascal Dufour's works published in journals are available:
<http://www.researcherid.com/rid/C-3926-2008>**

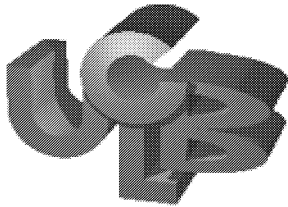

**Predictive control of a
nonlinear distributed parameter system :
real time control of a painting film drying process**

Co-authors : M.C. Larabi, P. Dufour, P. Laurent, Y. Touré

Presented by : P. Dufour

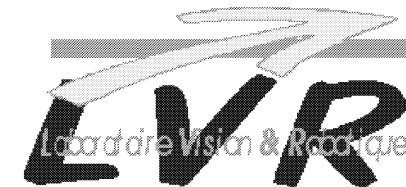

Context

Process control difficulties are increasing :

↪ necessity of more accurate models :

- dynamic aspect
- **independant space variables**
- **nonlinear physical phenomena**

↪ **nonlinear partial differential equations.**

Objectives

Extend the use of the **predictive control strategy** from systems described by **ordinary differential equations** to systems described by **partial differential equations.**

Infrared drying process

of painting film [Blanc et al., 1998]

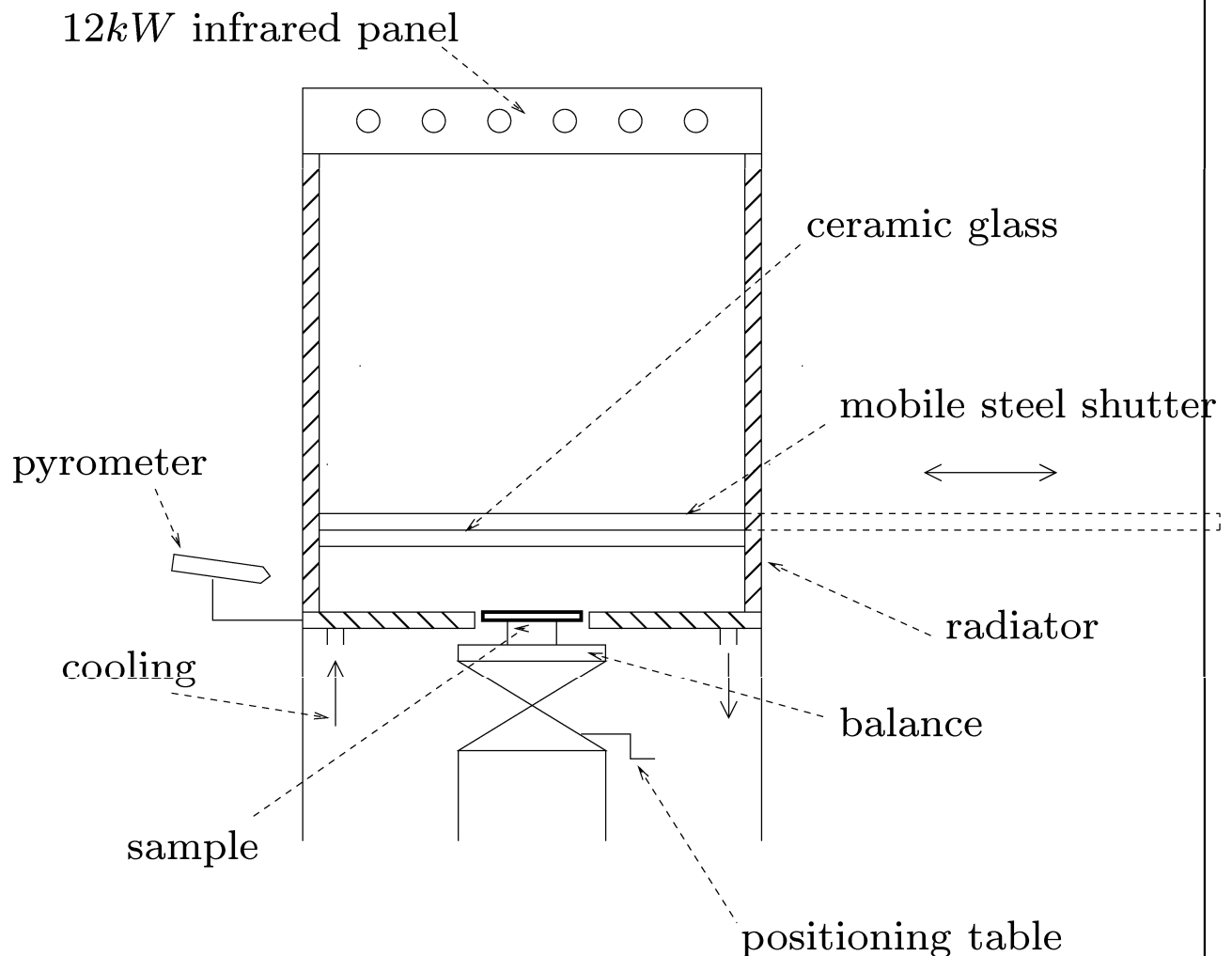

Control problem : trajectory tracking

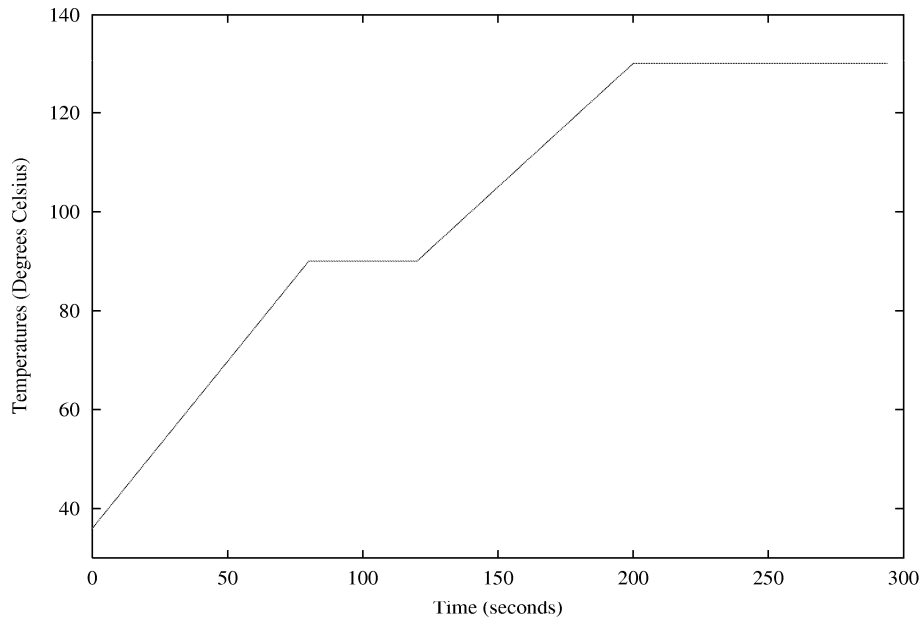

Temperature reference trajectory

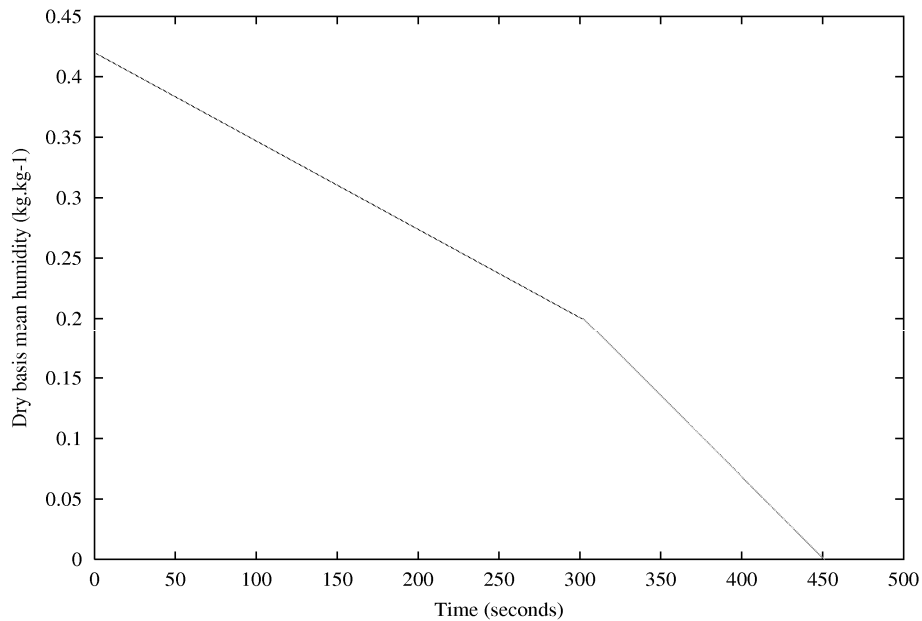

Humidity reference trajectory

Internal model control structure

[Morari and Zafiriou, 1983]

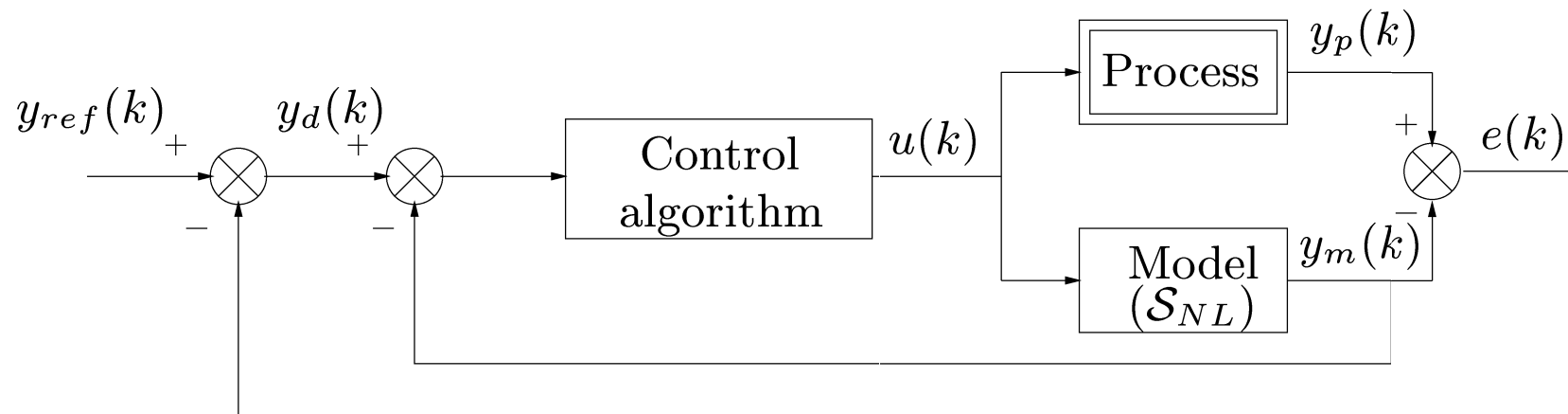

Predictive control strategy

[Richalet et al., 1976]

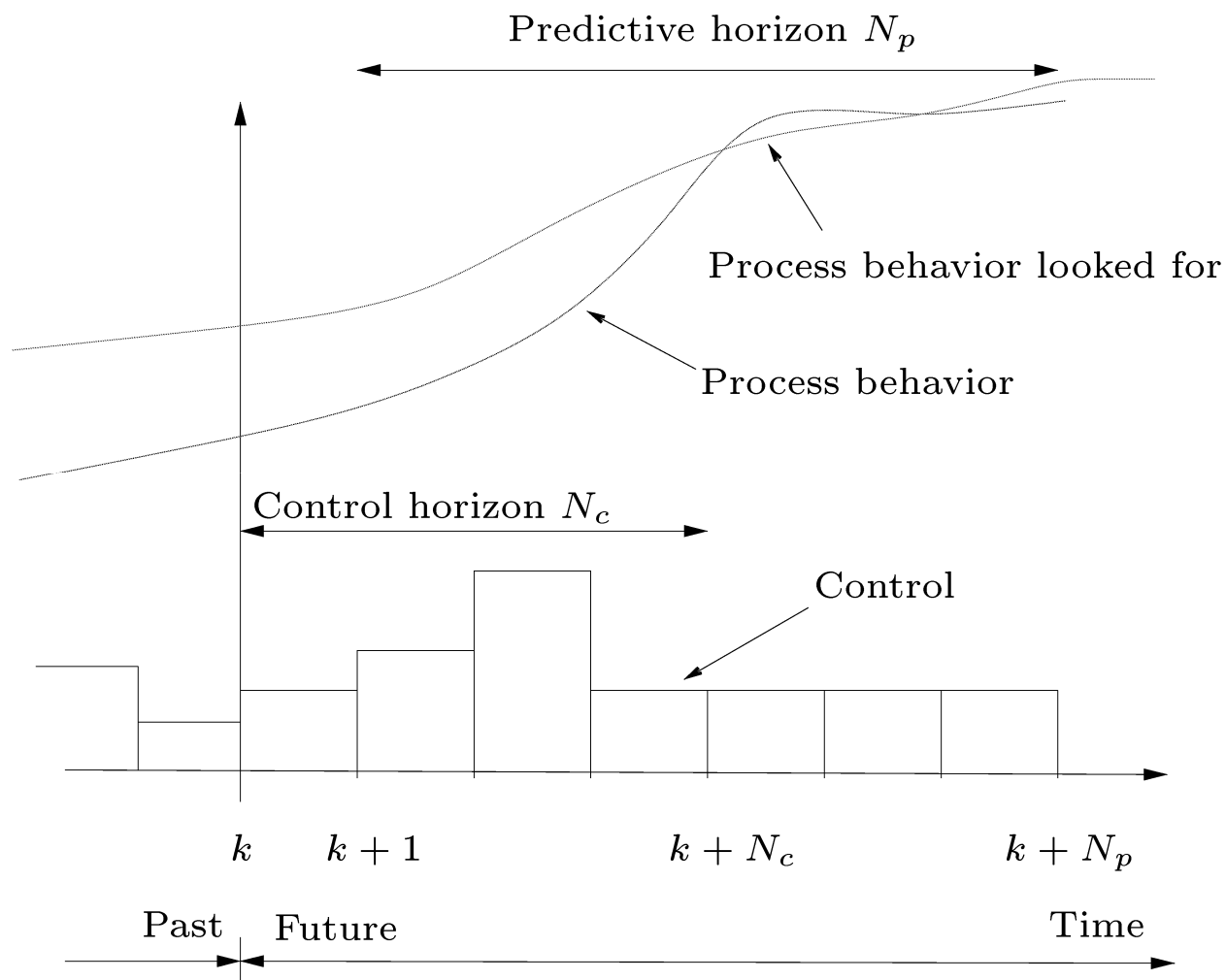

Problems encountered :

- real time resolution
- horizons choice
- structural aspects (feasibility, stability)

Thermal flows

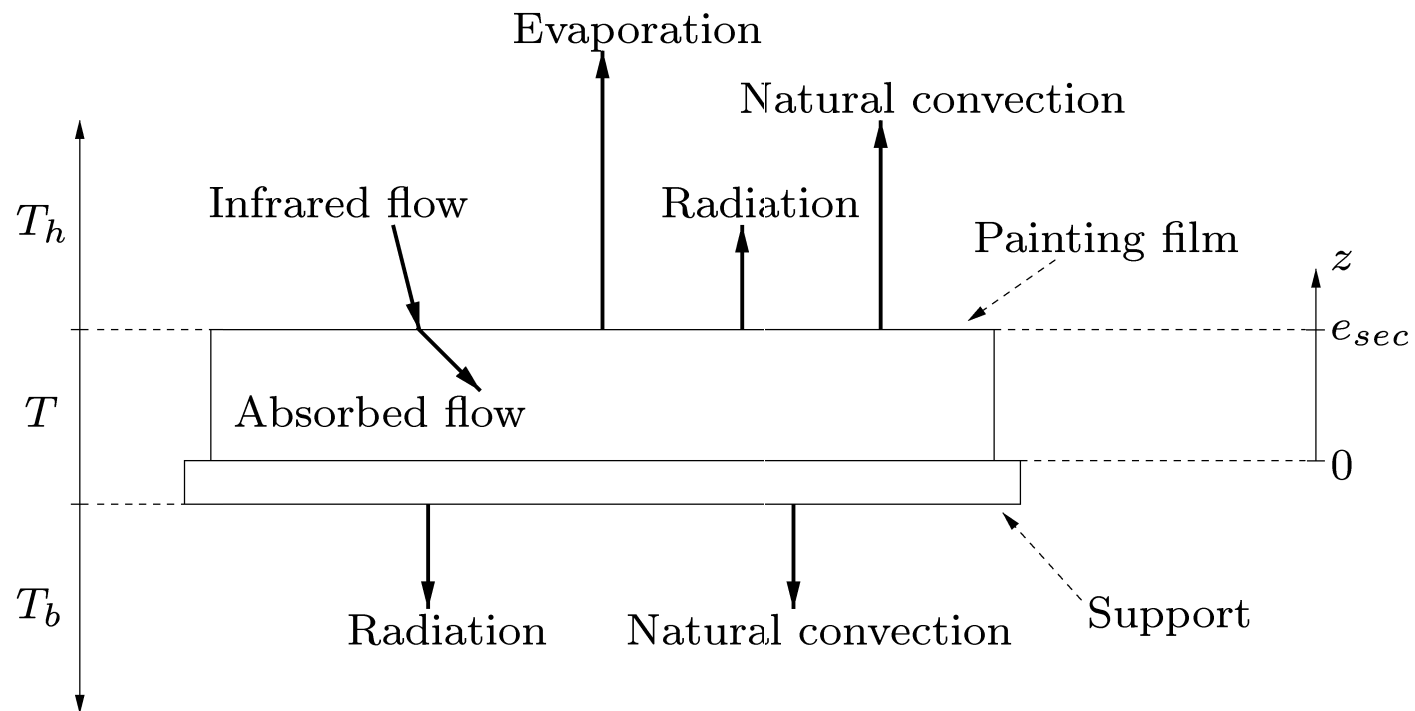

Energy balance

$$\begin{cases} (\rho_p C_p(\bar{\chi}, T)e_p + \rho_s C_s e_s) \frac{\partial T}{\partial t} = - \sum_{i=1}^5 P_i + P_{abs} \\ T(0) = T_0 \end{cases} \quad (1)$$

with the losses P_i :

$$\begin{cases} P_1 = h_c(T - T_b), \quad P_2 = \sigma_2(T^4 - T_b^4) \\ P_3 = h_c(T - T_h), \quad P_4 = \sigma_4(T^4 - T_h^4) \\ P_5 = l_v(T)\dot{m}(\bar{\chi}, T) \end{cases} \quad (2)$$

and the absorbed infrared flow :

$$P_{abs} = \alpha_{ir}(\bar{\chi})\varphi_{ir}(t) \quad (3)$$

Mass balance

$$\frac{\partial \chi}{\partial t} = \frac{\partial}{\partial z} \left[D_{eff}(\chi, T) \frac{\partial \chi}{\partial z} \right] \text{ for } 0 < z < e_{sec}, t > 0$$

$$\text{with } D_{eff}(\chi, T) = \frac{D_0 \exp\left(\frac{-a}{\chi}\right) \exp\left(\frac{-Ea}{RT}\right)}{(1+\phi\chi)^2}$$

with the boundary conditions :

$$-D_{eff}(\chi, T) \frac{\partial \chi}{\partial z} = \frac{\dot{m}(\bar{\chi}, T)}{\rho} \text{ for } z = e_{sec}, t > 0 \quad (4)$$

$$\frac{\partial \chi}{\partial z} = 0 \text{ for } z = 0, t > 0$$

with the initial condition :

$$\chi(z, 0) = x_i(z) \text{ for } 0 \leq z \leq e_{sec}$$

Internal linearized time-variant

model control structure

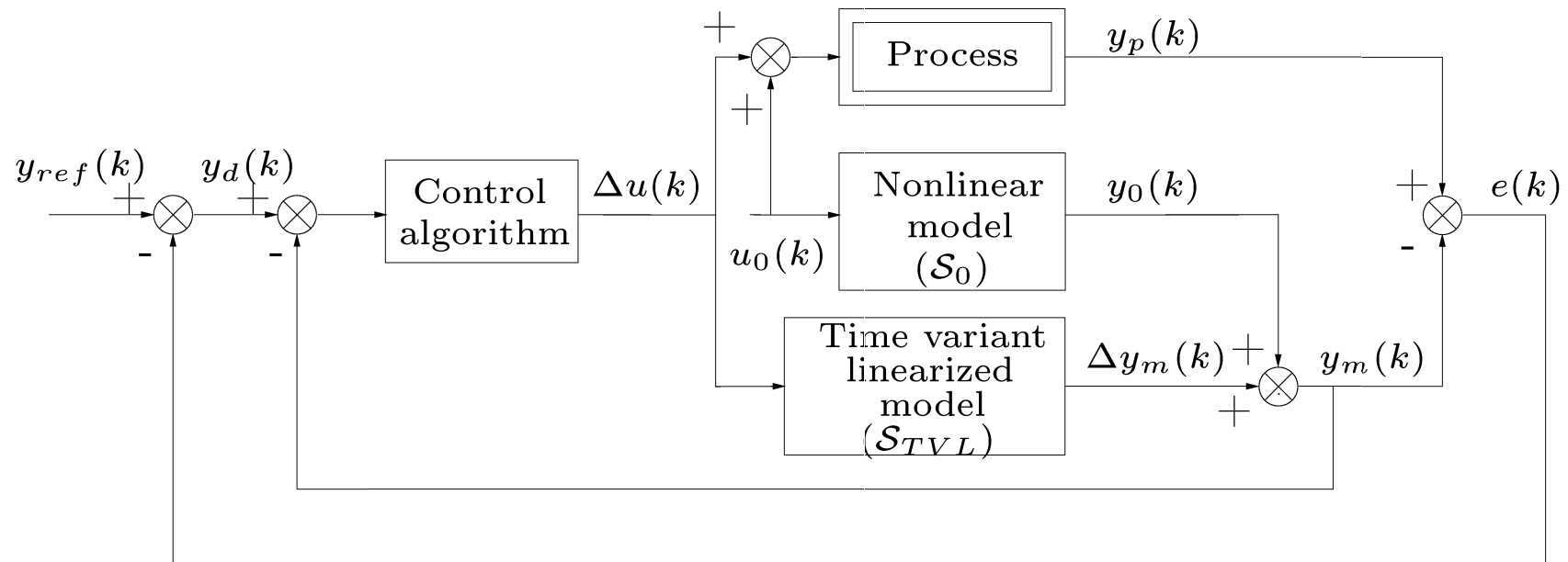

Real time aspect :

variation model

A model **linearization** about (\mathcal{S}_0) characterised by (u_0, x_0, y_0) , with variations checking :

$$\begin{cases} u(k) = u_0(k) + \Delta u(k) \\ x(k) = x_0(k) + \Delta x(k) \\ y_m(k) = y_0(k) + \Delta y_m(k) \end{cases} \quad (5)$$

leads to :

$$(\mathcal{S}_{LTV}) \begin{cases} \frac{\partial \Delta x}{\partial t} = \frac{\partial F_d}{\partial x|_{(S_0)}} \Delta x \text{ over } \Omega \times]0, +\infty[\\ \frac{\partial F_b}{\partial x|_{(S_0)}} \Delta x + \frac{\partial F_b}{\partial u|_{(S_0)}} \Delta u = 0 \text{ over } \partial\Omega \times]0, +\infty[\\ \Delta y_m = C \Delta x \text{ over } \bar{\Omega} \times]0, +\infty[\\ \Delta x(z, 0) = 0 \text{ with } z \in \bar{\Omega} \end{cases} \quad (6)$$

Real time constrained optimization problem

$$\left\{ \begin{array}{l}
 \min_{\Delta \tilde{u}} J(\Delta \tilde{u}) = \frac{1}{N_p} \sum_{j=k+1}^{j=k+N_p} g(\Delta u(j-1), \Delta y_m(j)) \\
 \Delta \tilde{u} = [\Delta u(k) \dots \Delta u(k + N_c - 1)]^T \\
 c_i(\Delta u(j-1)) \leq 0 \quad (i \in \mathcal{I}, j \in \{k+1, k+N_c\}) \\
 (\mathcal{S}_{LTV}) \left\{ \begin{array}{l}
 \frac{\partial \Delta x}{\partial t} = \frac{\partial F_d}{\partial x|_{(S_0)}} \Delta x \text{ over } \Omega \times]0, +\infty[\\
 \frac{\partial F_b}{\partial x|_{(S_0)}} \Delta x + \frac{\partial F_b}{\partial u|_{(S_0)}} \Delta u = 0 \text{ over } \partial\Omega \times]0, +\infty[\\
 \Delta y_m = C \Delta x \text{ over } \bar{\Omega} \times]0, +\infty[\\
 \Delta x(z, 0) = 0 \text{ with } z \in \bar{\Omega}
 \end{array} \right.
 \end{array} \right. \quad (7)$$

Hard constraints handling : transformation method

From the **constrained variable** θ :

$$\theta_{\min} \leq \theta \leq \theta_{\max} \quad (8)$$

an **unconstrained variable** p is defined such that:

$$\theta = f(p) = \frac{1}{2}(\theta_{\max} + \theta_{\min}) + \frac{1}{2}(\theta_{\max} - \theta_{\min}) \tanh(p) \quad (9)$$

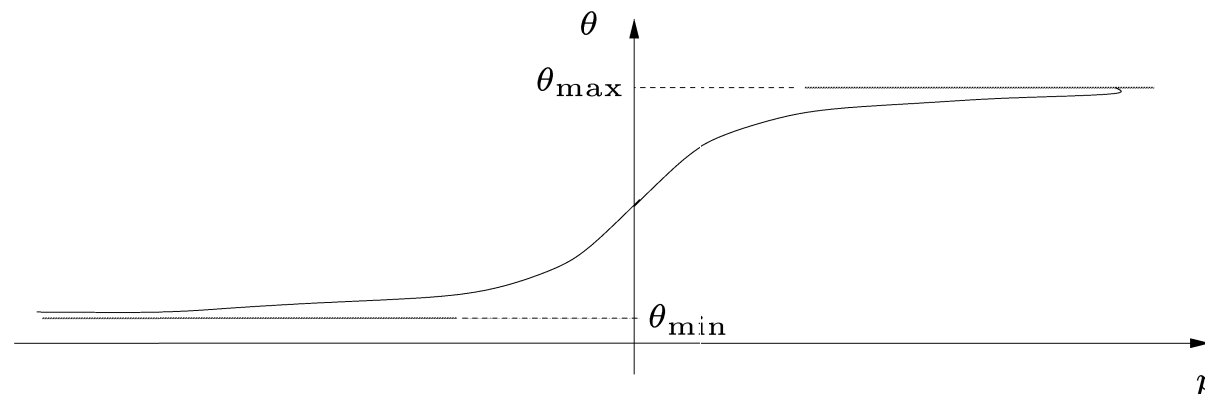

Experimental results

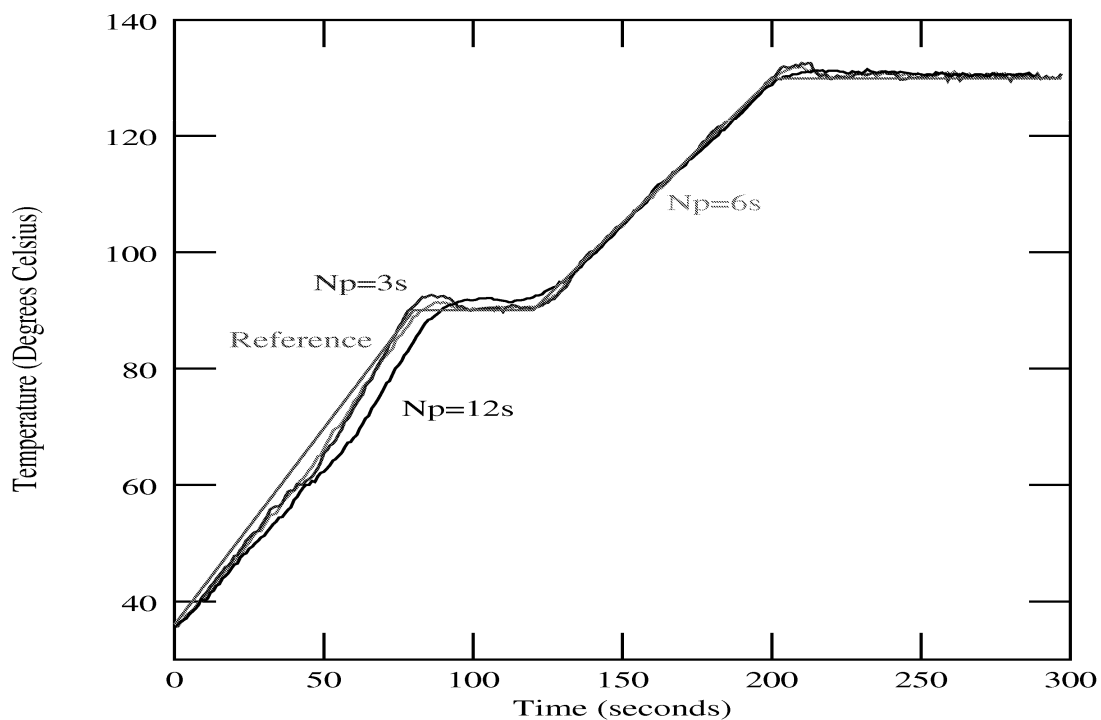

Trajectory tracking

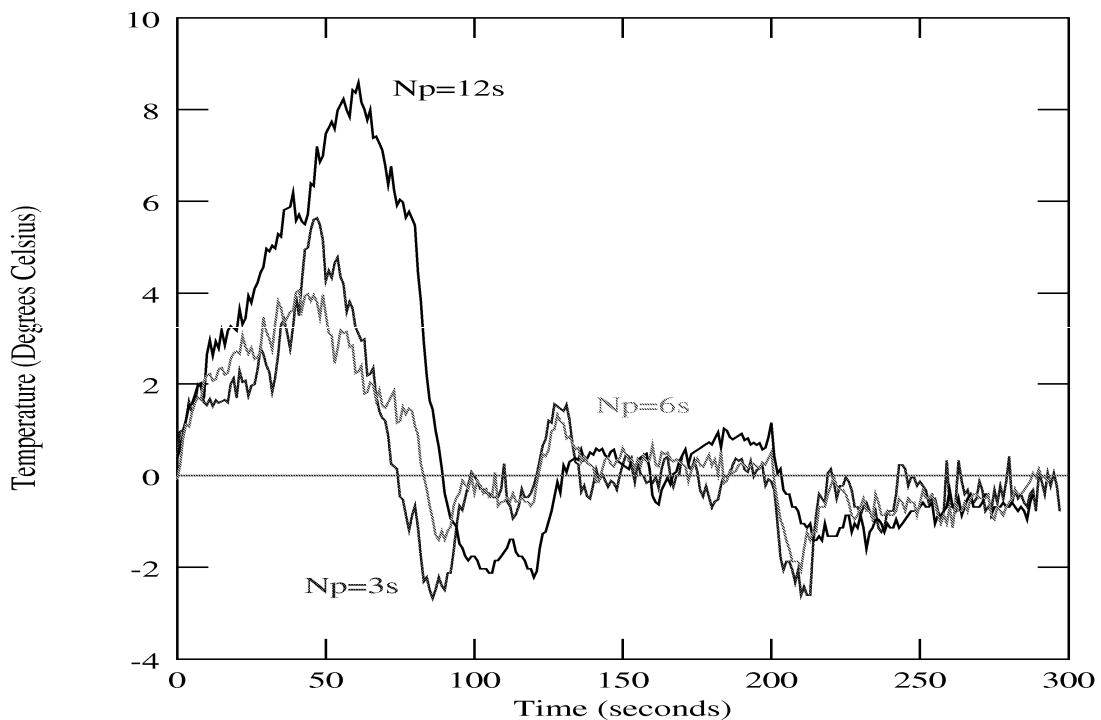

Tracking error

Experimental results

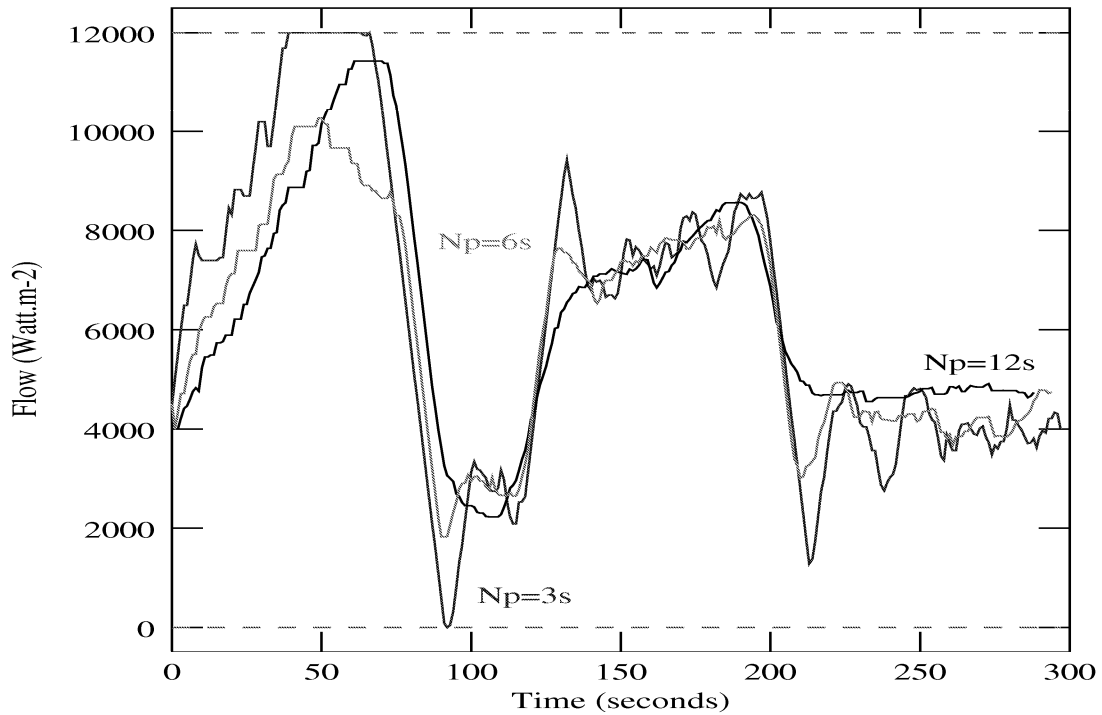

Control magnitude

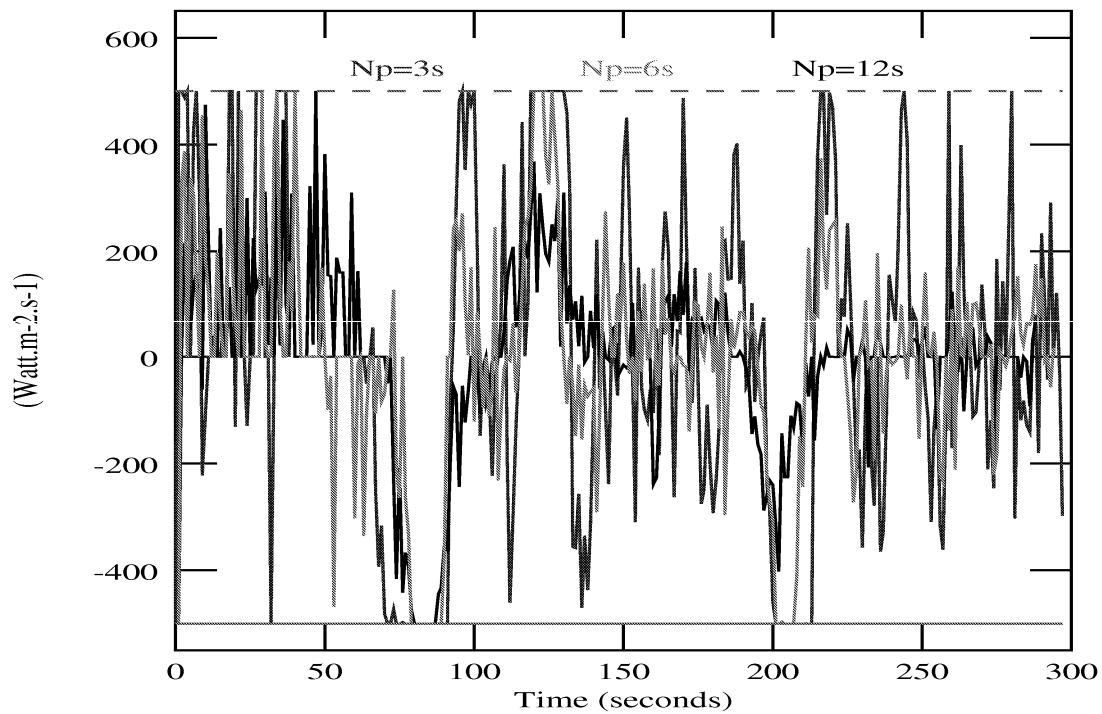

Control velocity

Experimental results

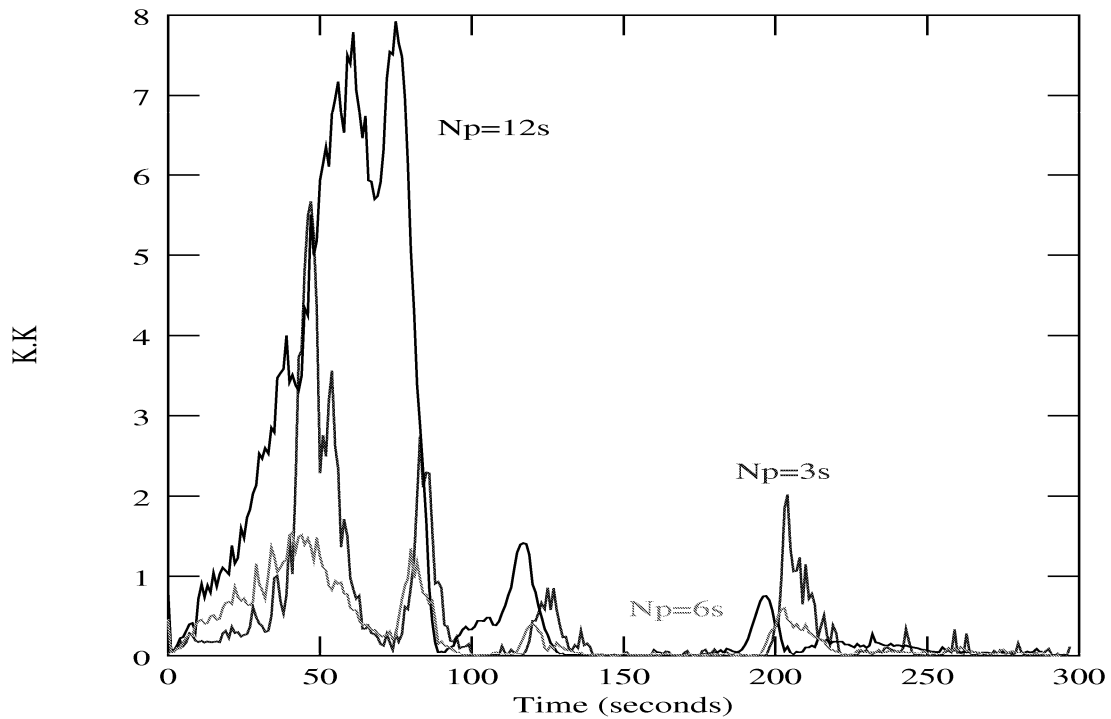

Cost function

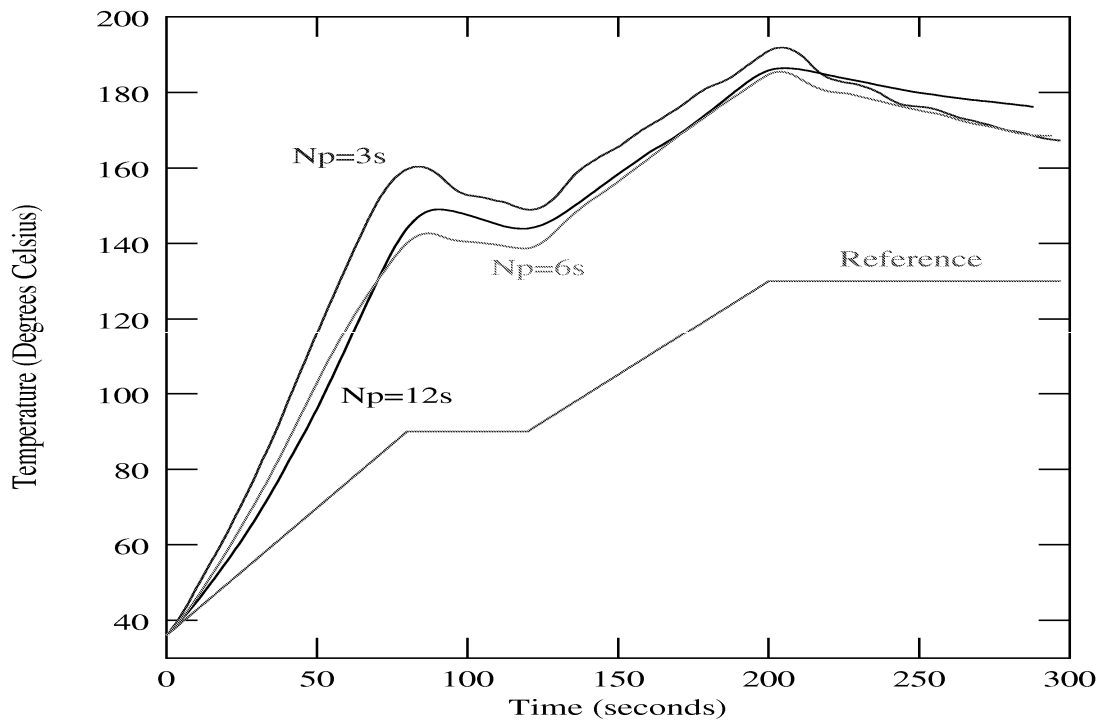

Model output

Conclusions

- **Extend** the use of the **model predictive control** strategy to complex systems :
 - ↪ described by **partial differential equations**
 - ↪ strongly **nonlinear phenomena**
- Real time control aspect :
 - ↪ **nominal behavior** given **off line**
 - ↪ **on line correction**
- Horizons influence
- Behavior interpretation :
 - ↪ **multi disciplinary** study.

Prospects

- For a **strongly noisy output** : use of a **receding horizon observer**.
- Stability of the closed loop system.