



**HAL**  
open science

## MPC as control strategy for pasta drying processes

Jeroen de Temmerman, Pascal Dufour, Bart Nicolai, Herman Ramon

► **To cite this version:**

Jeroen de Temmerman, Pascal Dufour, Bart Nicolai, Herman Ramon. MPC as control strategy for pasta drying processes. *Computers & Chemical Engineering*, 2009, 33 (1), pp.50-57. 10.1016/j.compchemeng.2008.06.004 . hal-00350086v2

**HAL Id: hal-00350086**

**<https://hal.science/hal-00350086v2>**

Submitted on 21 Jan 2009

**HAL** is a multi-disciplinary open access archive for the deposit and dissemination of scientific research documents, whether they are published or not. The documents may come from teaching and research institutions in France or abroad, or from public or private research centers.

L'archive ouverte pluridisciplinaire **HAL**, est destinée au dépôt et à la diffusion de documents scientifiques de niveau recherche, publiés ou non, émanant des établissements d'enseignement et de recherche français ou étrangers, des laboratoires publics ou privés.

**This document must be cited according to its final version  
which is published in a journal as:**

**J. De Temmerman<sup>1</sup>, P. Dufour<sup>2</sup>, B. Nicolai<sup>1</sup>, H. Ramon<sup>1</sup>,  
"MPC as control strategy for pasta drying processes",  
Computers and Chemical Engineering, ISSN: 0098-1354  
2009, 33(1), 50-57.**

**<http://dx.doi.org/10.1016/j.compchemeng.2008.06.004>**

**All open archive documents of Pascal Dufour are available at:  
<http://hal.archives-ouvertes.fr/DUFOUR-PASCAL-C-3926-2008>**

**The professional web page (Fr/En) of Pascal Dufour is:  
<http://www.lagep.univ-lyon1.fr/signatures/dufour.pascal>**

1

K.U. Leuven,  
BIOSYST – MeBioS,  
Kasteelpark Arenberg 30,  
B-3001 Leuven, Belgium  
<http://www.biw.kuleuven.be/mebios/>

2

Université de Lyon, Lyon, F-69003, France; Université Lyon 1;  
CNRS UMR 5007 LAGEP (Laboratoire d'Automatique et de Génie des Procédés),  
43 bd du 11 novembre, 69100 Villeurbanne, France  
Tel +33 (0) 4 72 43 18 45 - Fax +33 (0) 4 72 43 16 99  
<http://www-lagep.univ-lyon1.fr/> <http://www.univ-lyon1.fr> <http://www.cnrs.fr>

# MPC as control strategy for pasta drying processes

J. De Temmerman<sup>a</sup>, P. Dufour<sup>b</sup>, B. Nicolai<sup>a</sup>, H. Ramon<sup>a</sup>

<sup>a</sup> BIOSYST – MeBioS, K.U. Leuven, Kasteelpark Arenberg 30,  
B-3001 Leuven, Belgium;

<sup>b</sup> Université de Lyon, Lyon, F-69003, France; Université Lyon 1; CNRS UMR 5007 LAGEP (Laboratory of Process Control and Chemical Engineering), 43 bd du 11 novembre, 69100 Villeurbanne, France ;

e-mail of corresponding author: [jeroen.detemmerman@biw.kuleuven.be](mailto:jeroen.detemmerman@biw.kuleuven.be)

phone number of corresponding author: [32-16-321922](tel:32-16-321922)

fax number of corresponding author: [32-16-328590](tel:32-16-328590)

## Abstract

This study focuses on the drying process of pasta in a convectional air drying oven. A model predictive control algorithm is designed, based on a dynamic model describing the mass transfer between pasta and the surrounding air. The multiple input single output control algorithm minimizes a cost function over a prediction horizon which represents the deviation of the process from a desired reference track, thereby incorporating the working limitations of the oven. The performance of the controller and the influence of the prediction horizon are examined in this paper, showing minimal deviation between process and reference track.

## Keywords:

drying process; model predictive control; nonlinear distributed parameter system; first principle model; moisture content

## **1. Introduction**

Drying is one of the most energy intensive industrial processes with applications in a wide variety of industries including food industry and construction industry (1). Traditional convective drying processes, which are performed in batchwise operations, employ continuous constant air temperature and relative humidity for moisture removal. The rate of migration of the moisture from within the pasta to the evaporation front often controls the overall drying rate for a batch of pasta (2). Thus, for optimal energy consumption and improved quality, it is important to match the energy demand of the product during drying with the external supply of energy. Moreover, optimal control of the moisture content and the efficient application of the energy inputs during drying reduce the drying times and hence the energy consumption. Control of drying operations is therefore helpful, in addition to reduce the cost of production and increase the quality (3, 4). Whereas control techniques are widely used in many industries, the number of applications of control in drying is relatively still modest (5). The use of control tools has started to emerge in drying applications only since 1979. In a second phase started around 1998, new trends based on optimization of a performance function solved by optimal control tools appeared. Since 1992, emerging applications have appeared with few papers in painting, pharmaceuticals, paper and wood applications (5). However, control structures for drying processes of pasta are not yet studied and applied for industrial use. Control actions in industrial companies are nowadays manually installed based on the practical process knowledge of the operators.

This research is concentrated around the efficient control during pasta drying. Presently, since the moisture content is unknown and uncontrolled during drying, pasta is industrially dried to a moisture level which is much lower than the legal threshold value for microbial safety. The implementation of an efficient controller will enable the process to be followed and to be directed towards a referential track, which is formulated as a function of quality aspects, economical imperatives and consumer concerns. The energy consumption can then be reduced by the efficient tracking of the moisture concentration in pasta, i.e. no additional energy will be spilled by the control actions (air temperature and relative humidity) to remove the extra unnecessary percentages of water out of the pasta with the consequence of a reduction in drying time. In process industry, pasta is namely dried to moisture contents, lower than the critical values for microbial contamination as the process moisture concentrations can not be measured online during production and biological variations in pasta materials influence the final moisture concentration. To reduce the (often unnecessary) last percentages of moisture out of pasta, long drying times are needed, consuming lots of energy. Control structures combined with online process measurements are therefore useful to reduce the drying time, and therefore the energy consumption.

In this work, a model predictive control system for pasta drying is built. The idea of model predictive control can be traced back to the 1960s (6,7). However, interest in this field started to surge only in the 1980s after publication of the first papers on IDCOM (8) and dynamic matrix control (DMC) (9) and the first comprehensive exposition of generalized predictive control (GPC) (10,11). DMC was conceived to tackle the

multivariable constrained control problems typical for the oil and chemical industries. In DMC, these problems were handled by single loop controllers augmented by various selectors, overrides, decouplers, time-delay compensators, etc. (12). GPC was intended to offer a new adaptive control alternative. In the tradition of adaptive control input-output (transfer function) models were employed. The GPC approach is not suitable or, at the very least, awkward for multivariable constrained systems which are much more commonly encountered in the oil and chemical industries than situations where adaptive control is needed (12). Essentially all vendors have adopted a DMC-like approach (13). The initial research on MPC is characterized by attempts to understand DMC, which seemed to defy a traditional theoretical analysis because it was formulated in a non-conventional manner. Many MPC approaches have been proposed along the past three decades, most of them based on a receding-horizon strategy, i.e., at each sampling instant  $k$  the following actions are taken (14):

- The plant measurements are updated for use in the feedback/feedforward control loop
- the plant model is used to predict the output response to a hypothetical set of future control signals,
- a function including the cost of future control actions and future deviations from a reference behavior is optimized to give the best future control sequence, and
- the first movement of the optimal control sequence is applied.

These operations are repeated at time  $k+1$ . The main advantage of MPC is its ability to address long time delays, inverse responses, significant nonlinearities, multivariable interactions and constraints (14). The widespread use and success of MPC applications

described in the literature attest to the improved performance of MPC compared to the classical control algorithm for control of difficult process dynamics.

However, due to the strong nonlinear character of the equations, a numerical solution technique must be used to solve these equations. The computational effort varies somewhat because some solution methods require only that a feasible (and not necessarily optimal) solution be found or that only an improvement be achieved from time step to time step. Nevertheless the effort is usually formidable when compared to the linear case and stopping with a feasible rather than optimal solution can have unpredictable consequences for the performance. The computational effort can be greatly reduced when the system is linearized first in some manner and then the techniques developed for linear systems are employed online. Nevistic (15) showed excellent simulation results when a linear time varying (LTV) system approximation is used, which is calculated at each time step over the predicted system trajectory (16). Zheng (17,18) used the MPC formulation in a closed-loop control strategy while reducing the online computational demand. The nonlinear MPC control law was thereby approximated by a linear controller which linearized the nonlinear model and assumed no constraints. The linear controller was then used to compute all future control moves. The online computation effort was significantly reduced in this manner since only the first control move was computed by solving the optimization problem.

A time-varying linear MPC algorithm based on Dufour and Touré (19) will be developed for this research. In order to control the drying of pasta, it is necessary to model the drying process at a fundamental level. The governing transport equation for moisture

content is formulated on the basis of a nonlinear partial differential equation (PDE). To provide an insight into the drying process and to elucidate the physics of the transport phenomena that arise during drying, it is necessary to solve this system. The MPC structure which takes into account constraints for the model input and output, is developed afterwards. Experimental results reveal the applicability of the MISO (Multiple Input Single Output) MPC structure in pasta drying companies.

## **2. General model structure**

The drying process of pasta was modelled with an uncoupled mass transfer model based on Fick's law for flat pasta (2). The mass transfer balance was founded on an internal moisture transport mechanism governed by the moisture gradient and interpreted mathematically based on an effective diffusion coefficient in Fick's law. The transport kinetics are entirely controlled by the internal transport resistance (2). The time and spatially dependent diffusion coefficient determines the internal transport kinetics totally and hence the overall drying time for moisture removal out of pasta (20, 21). Moreover, calculations of the Fourier number confirm that the diffusion in pasta is the time determining key factor during drying. Moisture transport was assumed to be one-dimensional along the smallest pasta thickness  $L$ . The surface of the pasta was surrounded by air with well-known properties (air temperature and relative humidity) on one side while the pasta was insulated with aluminum-foil on the other side. The shrinkage of pasta is included in the model by considering it as a one-directional



phenomenon with a volume reduction, only attributed to the moisture loss. The unidirectional Fickian diffusion equation which relates moisture concentration to time and space is formulated as (2):

$$\frac{\partial X}{\partial t} = \frac{\partial}{\partial \xi} \left[ \left( \frac{D(X, T_{air})}{(1 + \psi X)^2} \right) \frac{\partial X}{\partial \xi} \right] \text{ for } t > 0 \text{ and } 0 < \xi < L \quad (1)$$

in which 
$$D(X, T_{air}) = a(T_{air}) \exp(bX) \text{ for } t > 0 \quad (2)$$

in which  $t$  is the time in s and  $\xi$  the Lagrangian coordinate in m.  $X(\xi, t)$  represents the moisture concentration in the pasta on dry basis, expressed in kg/kg,  $D(X, T_{air})$  the diffusion coefficient in  $m^2/s$ ,  $\psi$  the volumetric shrinkage coefficient,  $a$  an Arrhenius function of  $T_{air}$  in  $m^2/s$ ,  $b$  a dimensionless constant of the diffusion coefficient and  $\partial$  the partial derivative operator.

The initial and boundary conditions for the mass transport were formulated as:

$$t=0 \text{ s: } X = X_0 \text{ for } 0 < \xi < \xi_L \quad (3)$$

$$t > 0 \text{ s: } -\frac{D(X, T_{air})}{(1 + \epsilon X)^2} \frac{\partial X}{\partial \xi} = 0 \text{ for } \xi = 0 \quad (4)$$

$$t > 0 \text{ s: } -\frac{D(X, T_{air})}{(1 + \epsilon X)^2} \frac{\partial X}{\partial \xi} = h_m(T_{air}) (c(T_{air}, X) - c_\infty(T_{air}, RH)) \text{ for } \xi = \xi_L \quad (5)$$

in which  $X_0$  represents the initial (assumed uniform) moisture concentration in the pasta in kg/kg,  $\xi_L$  the total length of the pasta expressed in the Lagrangian coordinate in m,  $h_m$

the mass convection coefficient in m/s,  $RH$  the relative humidity of the drying air and  $T_{air}$  the air temperature of the drying air in °C. The numerical values and the expressions of all model parameters are shown in detail in another study (2). Fick's model equation with the distributed diffusion parameter, combined with the boundary and initial conditions can only be solved by numerical discretization techniques. This model describes the moisture concentration in pasta as a function of the input parameters, the drying air temperature and the relative humidity. The model can be considered as a MISO model. This MISO model has in general the form of:

$$\frac{\partial X}{\partial t} = F_d \left( \frac{\partial^2 X}{\partial \xi^2}, \frac{\partial X}{\partial \xi}, X, T_{air} \right) \quad (6)$$

$$F_{b_0} \left( \frac{\partial X}{\partial \xi} \Big|_{\xi=0}, X \Big|_{\xi=0}, T_{air} \right) = 0 \quad (7)$$

$$F_{b_L} \left( \frac{\partial X}{\partial \xi} \Big|_{\xi=\xi_L}, X \Big|_{\xi=\xi_L}, T_{air}, RH \right) = 0 \quad (8)$$

in which  $F_d$  is the nonlinear function of the partial differential equation, while  $F_{b_0}$  and  $F_{b_L}$  are nonlinear operators for the boundary conditions at the surface impermeable for moisture transport and at the surface in contact with the surrounding air respectively. This MISO model is named a  $S_{NL}$  model which stands for the nonlinear drying system. This model is the basis on which the MPC structure is built.

### 3. MPC formulation

MPC refers to a control strategy in which the dynamic model equations (6) – (8) are used to predict and optimize the drying process. In this control application, the drying process is optimized by internal model control for the manipulated input variable consisting of both drying air temperature and relative humidity  $u(t)=[T_{air}(t) RH(t)]$ . The control problem is solved by calculating  $S_0$  offline ( $S_0$  is  $S_{NL}$  obtained with  $u(t)=u_0(t)$ ), while  $S_{LTV}$  is computed online during MPC optimization. The offline model  $S_0$ , the online model  $S_{LTV}$  and the difference  $e$  between the process and model outputs then replace the nonlinear model  $S_{NL}$  into the optimization. This linearized model contributes to a significant reduction in online computational time. It must be taken into account that communication between the control software and the online measuring system requires a non negligible time. Therefore, within this strategy of calculating a part of the solution offline, the remaining time between two successive measuring points can be used efficiently to find an optimal solution that performs well with the MPC algorithm.

The control objective is then to find the variation  $\Delta u(t)$  of the manipulated variable  $u(t)$  around the chosen trajectory  $u_0(t)$  leading to a better online optimization result (22). The online linearization thus allows adding variations around the general offline calculated trend, reaching a much higher performance for the MPC formulation: more iterations are possible to find the solution, and the control performances are increased.

### 3.1 *General considerations*

In the MPC formulation, the nonlinear system  $S_{NL}$  is divided into a particular representation  $S_0$  of  $S_{NL}$  and a linearized term, named  $S_{LTV}$ .  $S_0$  stands for the particular solution of the nonlinear model for the input  $u_0(t)$  and state  $X_0(\zeta, t)$ , while  $S_{LTV}$  represents a time-varying linearized model, obtained by small variations  $\Delta u(t) = [\Delta T_{air}(t) \Delta RH(t)]$  and  $\Delta X(\zeta, t)$  around respectively the input  $u_0(t)$  and state  $X_0(\zeta, t)$ . This linearized model is described by (22):

$$\frac{\partial \Delta X}{\partial t} = A_d^2(t) \frac{\partial^2 \Delta X}{\partial z^2} + A_d^1(t) \frac{\partial \Delta X}{\partial z} + A_d^0(t) \Delta X + B_d(t) \Delta T_{air} \quad (9)$$

$$A_{b_0}^1(t) \frac{\partial \Delta X}{\partial z} + A_{b_0}^0(t) \Delta X + B_{b_0}^T(t) \Delta T_{air} = 0 \quad (10)$$

$$A_{b_L}^1(t) \frac{\partial \Delta X}{\partial z} + A_{b_L}^0(t) \Delta X + B_{b_L}^T(t) \Delta T_{air} + B_{b_L}^{RH}(t) \Delta RH = 0 \quad (11)$$

The time varying linear operators in these equations are obtained from the linearization of  $S_{NL}$  around the behavior described by  $S_0$  (23).

### 3.2 Control objective

The control objective of pasta drying is a trajectory tracking for the average moisture concentration of pasta. The average moisture concentration is forced to follow a reference curve, which is formulated in industry as a function of the actual consumer and legal requirements. The reference curves are namely a function of quality aspects (no cracking of pasta is allowed, minimal brownness is required) and legal limitations (maximal tolerated moisture content). They are given by an industrial pasta firm. In this study, a

standard referential curve of an industrial pasta firm was taken. To follow such reference track, input and output constraints must be taken into account. A cost function is formulated here for the drying process, which is minimized by the MPC control algorithm.

### 3.2.1 Input constraints

The input parameters of the considered drying model are constrained by their working area and by the time needed to establish the drying air conditions in the working area. The pasta product in this study was assumed to be dried in an oven [Weiss Technik, Germany] by using temperatures between 1°C and 100°C and relative humidity varying from 1% to 100%. The oven considered had a heating velocity of 1.5°C/min and a cooling velocity of -3°C/min. The velocity for changes in relative humidity was measured under several constant and variable air temperatures, indicating a humidity velocity for both humidification and dehumidification of +/-0.5%RH/min. These limitations on the working area of the oven were taken into the controller mathematically as:

$$u_{\min} \leq u \leq u_{\max} \quad (12)$$

$$\dot{u}_{\min} \leq \dot{u} \leq \dot{u}_{\max} \quad (13)$$

in which  $u_{\min}$  and  $u_{\max}$  represent the minimal and maximal constraint input, while  $\dot{u}_{\min}$  and  $\dot{u}_{\max}$  are the minimal and maximal velocity for the input. In order to be used in the control algorithm, explicit constraints on the manipulated input parameter  $u$  require a

transformation method to translate the input parameters into an unconstrained parameter  $p$ . Therefore the following transformation equation is used (22):

$$u = f_{moy} + f_{amp} \tanh\left(\frac{p - f_{moy}}{f_{amp}}\right) \quad (14)$$

with:

$$f_{moy} = \frac{(f_{\max} + f_{\min})}{2} \quad (15)$$

$$f_{amp} = \frac{(f_{\max} - f_{\min})}{2} \quad (16)$$

$$f_{\max} = \min(u_{\max}, u(j-1) + \dot{u}_{\min}) \quad (17)$$

$$f_{\min} = \max(u_{\min}, u(j-1) + \dot{u}_{\max}) \quad (18)$$

and the future discrete times  $j$  at each current discrete time  $k$  is:

$$j \in \{k+1, \dots, k+N_p\} \quad (19)$$

At each sampling time  $k$ , the working range for the input parameters is calculated starting from the previous input  $u(k-1)$ . The maximal and minimal input velocities  $\dot{u}_{\min}$  and  $\dot{u}_{\max}$  are therefore added and subtracted to the previous input and compared with the overall tolerated working zone limits, defined by  $u_{\min}$  and  $u_{\max}$  (equations (17) and (18)). The average value  $f_{moy}$  and amplitude value  $f_{amp}$  of the working range are consequently

considered (equations (15) and (16)) and used to transform the constrained input parameter  $u$  into the unconstrained parameter  $p$ , which is used further on in the MPC optimization algorithm. The control move is then physically feasible at any time and at any iteration: the constrained input parameter  $u$  determines the working range for the inputs of the drying model.

### 3.2.2. Output constraints

The average moisture concentration of pasta is assumed to follow a reference track during air drying to satisfy food quality, concerning product stability, texture and color. In order to produce high quality pasta, the evolution of the average moisture concentration must be situated between minimal and maximal boundaries. These constraints on the process output are formulated as a band around the reference track in which deviations between the process and reference curve are tolerated. Concentrations falling out of the toleration band have to be forced to move towards the reference curve by the control algorithm. The concentration limits for the moisture contents are mathematically expressed:

$$Co_i(y_p(t), u(t)) \leq 0 \quad (20)$$

in which  $Co_i$  represents the constraint function for the process output constraints. The constraint functions  $Co_1$  and  $Co_2$  in this study represent the transforming functions for the

maximal and minimal tolerated moisture concentrations  $y_p^{MAX}(t)$  and  $y_p^{MIN}(t)$  around the reference track respectively:

$$Co_1 = \left( \frac{y_p(t)}{y_p^{MAX}(t)} - 1 \right) \quad (21)$$

$$Co_2(t) = \left( 1 - \frac{y_p(t)}{y_p^{MIN}(t)} \right) \quad (22)$$

### 3.2.3 Linearization

The small input variations  $\Delta u(t)$ , small state variations  $\Delta X(\zeta t)$  and small output variations  $\Delta y_m(t)$  are used in the time-varying linearized model  $S_{LTV}$ . The offline solved nonlinear model  $S_0$  and the online solved time-varying linearized model  $S_{LTV}$  with the error  $e(t)$  then replace the initial nonlinear model  $S_{NL}$ , while the model output  $y_m(t)$  is defined as the sum of the nonlinear offline solved output  $y_0(t)$  and the linearized output  $\Delta y_m(t)$  (*Fig. 1*). Moreover, by discrete time formulation, the time dependent input, output and states can be expressed as a function of the discrete time index  $j$ , defined by (19). The process output  $y_p(j)$  is then:

$$y_p(j) = y_0(j) + \Delta y_m(j) + e(k) \quad (23)$$



in which the difference  $e(k)$  between the process and model outputs is assumed constant over the prediction horizon. This error  $e(k)$  is also fed back in the controller and is updated at each time  $k$ . Therefore, two feedback loops are used to adjust process performances (24).

The small variations  $\Delta u(j)$  can be reformulated as unconstrained parameter variations  $\Delta p(j)$  based on equation (14). The control objective is then to find the variation  $\Delta p(t)$  of the unconstrained manipulated variable  $p(t)$  about the chosen trajectory  $p_0(t)$  leading to a better online optimization result. As a consequence the output constraints (20) are then considered as:

$$Co_i(y_0(j), \Delta y_m(j), e(k), \Delta p(j)) \leq 0 \quad (24)$$

### 3.2.3. Cost function

A cost function  $J_{tot}$  is introduced to quantify the deviation of the process from the reference behavior and the positioning of the process output compared to the concentration band around the reference curve. The output constraints are taken into account in the second term of  $J_{tot}$  by adopting the exterior penalty method where a positive defined weighted penalty term is added to the initial cost function  $J$  (24):

$$\min_{\Delta p} J_{tot} = J(j) + J_{ext}(j) = J(j) + \omega_i \max^2(0, Co_i(j)) \quad (25)$$

where  $J(j)$  incorporates the deviation of the process from the reference behavior and  $\omega_i$  is a positive defined weight that increases when the output constraints tend to be checked and decreases when they do not tend to be checked (24). For any constraint  $Co_i$  not checked, the weight  $\omega_i$  penalizes the minimization task. This enforces the optimizer to minimize  $J_{ext}(j)$  and hence to enforce the violated constraints to be checked. The problem is thus transformed into an unconstrained penalized optimization problem by substituting a penalty function for the constraint (24).

Minimization of the cost function  $J_{tot}$  is obtained by manipulating the input parameters  $\Delta p$  of the model, thereby taking into account the constraints on the input:

$$\min_{\Delta p} J_{tot} = \sum_{k=1}^{N_p} \left( \left[ \frac{(y_{ref}(j) - [y_0(j) + \Delta y_m(j) + e(k)])}{y_{ref}(j)} \right]^2 + \omega_1 \max^2(0, Co_1(j)) + \omega_2 \max^2(0, Co_2(j)) \right) \quad (26)$$

where  $k$  stands for the actual discrete time,  $y_{ref}(j)$  for the future trajectory track,  $y_0(j)$  for output of the  $S_0$  model,  $\Delta y_m(j)$  for output of the  $S_{LTV}$  model,  $e(k)$  for the difference between process and model output, while  $\omega_1$  and  $\omega_2$  are the penalization factors for  $Co_1(j)$  and  $Co_2(j)$ .

### 3.3. Control algorithm

To optimize the input parameter  $\Delta p$  at each time  $k$ , the Levenberg-Marquardt algorithm is used due to its robustness, simplicity and convergence criteria. In this optimization algorithm the argument  $\Delta p_{i+1}$  is calculated starting from  $\Delta p_i$  by the following iteration:

$$\Delta p_{i+1} = \Delta p_i - (\nabla^2 J_{tot} + \lambda I)^{-1} \nabla J_{tot} \quad (27)$$

in which  $\lambda$  represents a blending factor which is recalculated at each iteration,  $I$  is the identity matrix, while  $\nabla$  is the gradient and  $\nabla^2$  the hessian with respect to  $\Delta p_i$ . In *Fig. 1* the structure of the MPC loop is shown.

#### 3.4. IMC PID control

The developed control strategy can also be used for IMC PID control. The difference between the referential value and process value at each process time (the error  $e$ ), which is now not evaluated over a prediction horizon, forms the basis to predict  $u(t)$  as the output of the PID controller and is mathematically expressed as:

$$u(t) = k_p e + k_i \int e dt + k_d \frac{d(e)}{dt} \quad (28)$$

The input parameter  $u(t)$  of the considered drying model is also constrained by their working area and its limits are identical as explained for MPC.

#### 4. MPC simulation results

The objective of the MPC system is to tune the input parameters that minimize the deviation between the process output and reference track. The average moisture concentration in pasta is controlled by adapting the input parameters of the system, namely the air temperature and relative humidity. The working area for the air temperature is constrained between 1°C and 100°C and for the relative humidity between 1% and 100%. The considered heating and cooling velocity are constrained to 1.5°C/min and -3°C/min respectively, while the relative humidity change is constrained to +/- 0.5%RH/min. The process output is considered by calculating  $S_0$  offline, while  $S_{LTV}$  is computed online during MPC optimization. The  $S_0$  model was calculated for  $u_0(t)=[49.5 \ 10]$ , in which the first number stands for the drying air temperature (in °C) and the second number for the relative humidity (in %). The sampling time was set to 60 s for a total drying process of 5000 s. The initial average moisture concentration of pasta in the model was assumed to be 47.7%. Deviations were introduced to check the adequacy and robustness of the controller: in order to create deviations between the actual process and model, the initial average moisture concentration of the process was set to 48.5%, while the diffusion coefficient of the process model was raised with 10.0%. Moreover real processes only deviate from the simulated models by parameter deviations. The real process can then be assumed as a process model with parameter deviations. However, online implementation requires highly precise measuring systems for the moisture content, evaluated over 60 s, which are not available for the moment, but are under

development. For the implementation, the MPC@CB software developed under Matlab was used.<sup>1</sup>

In *Fig. 2* convergence of the process towards the reference track is shown for various control strategies. The deviation between the drying process and reference track is minimal with the MPC. Since a higher diffusion coefficient of the model than in the process speeds up the modeled drying, the MPC controller has to intervene in the control loop by decreasing the air temperature or/and increasing the relative humidity in order to direct the process towards the reference curve. The small temperature increase at the beginning of the drying process is caused by the deviation in the initial moisture concentration of the process, after which the temperature decreases to counterbalance the effect of the diffusion coefficient for the simulated process. With a prediction horizon consisting of 5 points considered for the MPC control algorithm, the root mean squared error (RMSE) between the average moisture concentration of the process and the reference track is 0.30% for this simulated process, which indicates the adequacy and performance are very good. The control magnitudes for the MPC strategy are shown in *Fig. 3* together with the minimal and maximal allowed input: the constrained control magnitudes are situated between the specified boundaries. The increase or decrease in the manipulated input variables is limited between two consecutive sampling points due to the constraints on the input variations caused by the oven used (*Fig. 4*).

In the first open loop case, the input magnitudes still remain constant at 49.5°C and 10% and do not counterbalance for the higher diffusion coefficient or the deviating initial

---

<sup>1</sup> © University Claude Bernard Lyon 1 – EZUS. In order to use MPC@CB, please contact the author: dufour@lagep.univ-lyon1.fr

moisture concentration. The uncontrolled process shows divergence from the reference track after 800s which only increases afterwards as there is no control action for this open loop system (*Fig. 2*). The RMSE between the average moisture concentration of the process and the concentration of the reference track for the open loop system is 4.36%.

Additionally, another open loop control case is given in *Fig. 2* for the drying conditions at 45.0°C and 20%, indicating again divergence from the referential curve. The drying air temperature of 45.0°C is not adequate to reach the referential curve as remained constant because there is no control (RMSE=4.12%).

An internal MISO PID, replacing the MISO MPC system is unable to take prediction horizons into account and hence cannot foresee the process. The optimal internal PID specifications are given in *Table 1*. The PID controller does not perform as well as the MPC controller (RMSE= 1.98%). The process is not controlled optimally by the PID between 500 s and 1500 s due to the lack of process evaluation over a prediction horizon. However, there is no bad impact of the PID controller on the tracking results. The constrained manipulated control magnitudes (temperature and relative humidity) for the applied internal MISO PID are given in *Fig. 3*. In *Fig. 4*, the variation in constrained manipulated control magnitudes between the successive sampling instants is shown for the MISO MPC and MISO PID controller. It is demonstrated that the inputs for the MISO PID controller are sometimes saturated, while the inputs of the MISO MPC system are situated between their maximal heating, cooling and humidification and dehumidification velocity.

The same MISO MPC control strategy is performed for prediction horizons including 2, 3, 4, 5, 7, 10 and 15 points. The deviation between process and reference track is

therefore also minimal. The influence of longer or shorter prediction horizon on the RMSE is shown in *Fig. 6*. As optimal prediction horizon, the prediction horizon which minimizes the RMSE is preferred. The optimal prediction horizon is always a function of the type of reference curve and the type of process. In *Fig. 6*, it is shown that a prediction horizon, consisting of 4 points, is optimal for tracking the reference curve. The prediction horizon has a different effect because the relative importance of the next input is varying for variable prediction horizons. The relative importance for the next applied input value increases for small prediction horizons, while it decreases for longer prediction horizons. Highly varying reference curves, for example, are better tracked by using short prediction horizons as it makes no sense to consider the future process behaviour when the reference is highly varying. The optimal RMSE between the process and reference track average moisture concentration is therefore 0.29%. For longer or shorter prediction horizons, the importance of the prediction horizon for calculating the next process value is respectively under- or overestimated i.e. the percentage contribution for the next process input value in the prediction horizon is under- or overestimated and hence the prediction horizon is preferred to be shorted or lengthened respectively.

The impact of both input parameters (air temperature and relative humidity) on the process output is analyzed in *Fig. 5* based on the sensitivities analysis. The following sensitivity ratio is defined:

$$\text{Ratio}(t) = \left( \frac{d\bar{X}}{dT_{\text{air}}(t)} \right) / \left( \frac{d\bar{X}}{dRH(t)} \right) \quad (29)$$

This sensitivity ratio ranges from 10 at the beginning, to 1 at the end. It is therefore obvious that the air temperature has more impact on the process than the relative humidity, explained by its influence on the diffusion process. The impact of the relative humidity is limited as it only intervenes in the boundary condition (equation (5)), but increases at the end of the drying process. One may then wonder if this may have an impact in term of closed loop control results, assuming a single input, single output (SISO) MPC structure rather than the MISO MPC structure. In this SISO MPC structure, the air temperature is assumed as input parameter and the relative humidity then remains constant during the whole drying process (RH=10% is used in the simulations). After some simulations, the RMSE between the average moisture concentration of the process and the reference track is 0.34% for this SISO MPC structure, indicating less adequate performance compared to the MISO model (0.29%). Using a MISO MPC instead of a SISO MPC therefore helps to decrease by 15% the RMSE between these two cases. The influence of the PID controller on the SISO model gives a RMSE of 2.08%, which also has less performance compared to the MISO PID control structure (1.98%). Using a MISO PID instead of a SISO PID therefore helps to decrease by 5% the RMSE between these two cases. *Table 2* helps to summarize the RMSE between the referential drying curve and the drying process output in open loop, with SISO and MISO PID controlled systems and with the best tuned SISO and MISO MPC controlled systems. It can be seen that the MISO MPC system is the best control structure during pasta drying processes.

For the MISO MPC structure, it is obvious that the whole calculation time during control calculations is reduced due to the offline calculation of the model. *Fig. 7* demonstrates



the calculation time for the prediction horizon consisting of 5 points and 10 points. The calculation results show the calculation time needed for the control actions is much lower than the sampling time for process output measuring during implementation (3-5 s versus a sampling time of 60 s for implementation respectively), indicating the control algorithm is very efficient in calculating the control actions. The remaining time between the successive samplings can then be used for the communication between the PC software and the actual process on a laboratory scale (approximately 10 s), and also to use a model based observer in order to estimate online some unknown or time-varying model parameters like the pasta temperature or diffusion coefficient or to recalculate the specified MISO MPC problem in order to find more optimal solutions.

## **5. Conclusion**

In the present study, a distributed parameter model predictive control framework is used based on computationally efficient MPC software for pasta during convective air drying. The control system is formulated based on an offline nonlinear model and an online time-varying linear model. The MPC controller combines the process output with a Levenberg-Marquardt optimization technique to provide a model predictive control framework that can be supported in an industrial environment. The smaller average deviation between the average moisture concentration of the product and the reference track curve was found to be 0.29% in the MISO MPC case. The proposed MISO MPC

produces high performance and accuracy, with relatively small computational cost and gives better results than PID, or SISO MPC with the air temperature as the single input.

The advantage of this developed control structure lies in its practical use. The implementation of the developed control structure is one the possible practical applications of this control structure. The MPC control strategy is therefore considered as a powerful research strategy with a variety of possibilities, even in other application areas such as freezing, painting, etc.

## **References**

1. Nimmol, C.; Devahastin, S.; Swasdisevi, T.; Soponronnarit, S. Drying and heat transfer behavior of banana undergoing combined low-pressure superheated steam and far-infrared radiation drying. *Applied Thermal Engineering* 2007, 27, 2483-2494.
2. De Temmerman, J.; Verboven, P.; Nicolai, B.; Ramon, H. Modelling of transient moisture concentration of semolina pasta during air drying. *Journal of Food Engineering* 2007, 80(3), 892-903.
3. Perera, C.O. Selected Quality Attributes of Dried Foods. *Drying Technology* 2005, 23, 717-730.
4. Menshutina, N.V.; Kudra, T. Computer Aided Drying Technologies. *Drying Technology* 2001, 19(8), 1825-1849.

5. Dufour, P. Control engineering in drying technology: Review and trends. *Drying Technology* 2006, 24(7), 889-904.
6. Garcia, C. E.; Prett, D. M.; Morari, M. Model predictive control: theory and practice - a survey. *Automatica* 1989, 25(3), 335-348.
7. Bosley, J. R.; Edgar, T. F.; Patwardhan, A. A.; Wright, G. T. Model-based control: a survey. *IFAC Symposia Series* 1992, 8, 127-136.
8. Richalet, J.; Rault, A.; Testud, J. L.; Papon, J. Model predictive heuristic control: Applications to industrial processes. *Automatica* 1978, 14, 413-428.
9. Cutler, C. R.; Ramaker, B. L. Dynamic matrix control: a computer control algorithm. In *Proceedings Joint Automatic Control Conference*, San Francisco, CA, 1980.
10. Clarke, D. W.; Mohtadi, C.; Tuffs, P. S. Generalized predictive control. Part 1: The basic algorithms. *Automatica* 1987, 23(2), 137-148.
11. Clarke, D. W.; Mohtadi, C.; Tuffs, P. S. Generalized predictive control. Part 2: Extensions and interpretations. *Automatica* 1987, 23(2), 149-160.

12. Morari, M.; Lee, J. L. Model predictive control: past, present and future. *Computers and Chemical Engineering* 1999, 23, 667–682.
13. Qin, S. J.; Badgwell, T. A. An overview of industrial model predictive control technology. In *J. C. Kantor, C. E. Garcia, & B. Carnahan (Eds.), Fifth International Conference on Chemical Process Control, CACHE, AIChE, 1997; 232-256.*
14. Giovanini, L.L. Predictive feedback control. *ISA Transactions* 2003, 42, 207–226.
15. Nevistic, V. Constrained control of non linear systems. PhD thesis, ETH-Swiss Federal Institute of Technology, Zürich, 1997.
16. Lee, J. H.; Ricker, N. L. Extended Kalman filter based nonlinear model predictive control. *Industrial and Engineering Chemistry Research* 1994, 33 (6), 1530–1541.
17. Zheng, A. A computationally efficient non linear model predictive control algorithm. In *Proceedings of the American Control Conference, Albuquerque, NM, 1997.*
18. Zheng, A. Non linear model predictive control of the Tennessee–Eastman process. In *Proceedings of the American Control Conference, Philadelphia, PA, 1998.*
19. Dufour, P.; Touré, Y. Multivariable model predictive control of a catalytic reverse flow reactor. *Computers and Chemical Engineering* 2004, 28, 2259–2270.

20. Villeneuve, S.; Gélinas, P. Drying kinetics of whole durum wheat pasta according to temperature and relative humidity. *LWT - Food Science and Technology* 2007, 40(3), 465-471.
21. Migliori, M.; Gabriele, D.; de Cindio, B.; Pollini, C.M. Modelling of high quality pasta drying: mathematical model and validation. *Journal of Food Engineering* 2005, 69(4), 387-397.
22. Dufour, P.; Touré, Y.; Blanc, D.; Laurent, P. On nonlinear distributed parameter model predictive control strategy: online calculation time reduction and application to an experimental drying process. *Computers and Chemical Engineering* 2003, 27, 1533-1542.
23. Friedly, J.C. *Dynamic behavior of processes*; Prentice-Hall Inc.; Englewood Cliffs, NJ, 1972.
24. Fletcher, R. *Practical methods of optimization*, John Wiley & Sons Ltd.; New York, 1987.

## List of abbreviations and symbols

$a$	Arrhenius function of the air temperature ( $m^2/s$ )
$b$	diffusion constant (-)
$Co$	constraint function for the process output constraints
$D$	diffusion coefficient ( $m^2/s$ )
DMC	dynamic matrix control
$e$	difference between process and model output (kg/kg)
$F_d$	nonlinear function of the partial differential equation
$F_{b_0}, F_{b_L}$	nonlinear functions for the boundary conditions
$f_{amp}$	difference between $f_{max}$ and $f_{moy}$ at the instant time
$f_{max}$	maximal constraint input at the instant time
$f_{min}$	minimal constraint input at the instant time
$f_{moy}$	average constraint input of $f_{min}$ and $f_{max}$ at the instant time
GPC	generalized predictive control
$h_m$	mass convection coefficient (m/s)
$I$	identity matrix
$J$	cost function incorporating the deviation of the process from the reference
$J_{tot}$	total cost function
$j$	future discrete time index (-)
$k$	actual discrete sampling time index (-)
$k_p$	proportional tuning factor ( $[kg \text{ } ^\circ C]/kg$ ) or (kg/kg)
$k_i$	integral tuning factor ( $[kg \text{ } ^\circ C]/[kg \text{ s}]$ ) or (kg/[kg s])
$k_d$	derivative tuning factor ( $[kg \text{ } ^\circ C \text{ s}]/kg$ ) or ( $[kg \text{ s}]/kg$ )
$L$	smallest pasta thickness (m)
LTV	linear time varying
MISO	Multiple Input Single Output
MPC	model predictive control
$N_p$	prediction horizon (-)
$p$	unconstrained manipulated input variable
$\Delta p$	unconstrained parameter variation around $p_0$
PDE	partial differential equation
$RH$	relative humidity (kg/kg)
$S_{LTV}$	linearized time-varying model, solved on-line
$S_{NL}$	nonlinear model
$S_0$	particular solution of the nonlinear model for the input $u_0(t)$ and state $X_0(\xi, t)$ , solved off-line
$T_{air}$	air temperature ( $^\circ C$ )
$t$	time (s)
$u$	input variable consisting of drying air temperature and relative humidity
$\Delta u$	small variation around the input $u$
$u_{max}$	maximal constraint input
$u_{min}$	minimal constraint input

$\dot{u}_{\max}$	maximal velocity for the input
$\dot{u}_{\min}$	minimal velocity for the input
$X$	moisture concentration in pasta on dry basis (kg/kg)
$X_0$	initial moisture concentration in pasta on dry basis (kg/kg)
$\Delta X$	small variation around $X$ (kg/kg)
$y_m$	model output
$\Delta y_m$	linearized output around $y_0$
$y_0$	nonlinear model output solved offline
$y_p$	process output
$y_p^{MAX}$	maximal tolerated moisture concentration
$y_p^{MIN}$	minimal tolerated moisture concentration
$y_{ref}$	trajectory track
$\zeta$	Lagrangian coordinate (m)
$\xi_L$	total length of the pasta expressed as a Lagrangian coordinate (m)
$\varepsilon$	tolerance factor
$\lambda$	blending factor
$\omega$	positive defined weight factor
$\psi$	volumetric shrinkage coefficient
$\partial$	partial derivative operator
$\nabla$	gradient operator
$\nabla^2$	hessian operator

Table 1: PID tuning parameters  $k_p$ ,  $k_i$  and  $k_d$  for air temperature and relative humidity control

<i>Air temperature</i>	$k_p$ [(kg dry solids °C)/kg water]	-2500.0
	$k_i$ [(kg dry solids °C)/(s kg water)]	-2.0
	$k_d$ [(kg dry solids °C s)/kg water]	$-1.10^{-3}$
<i>Relative humidity</i>	$k_p$ [(kg dry solids)/kg water]	6.0
	$k_i$ [(kg dry solids)/s kg water]	$1.10^{-3}$
	$k_d$ [(kg dry solids s)/kg water]	$1.10^{-3}$



*Table 2: RMSE (%) between the referential curve and the drying process output: with open loop control while  $u=u_0=[49.5^{\circ}\text{C } 10.0\%]$  and  $u=u_0=[45.0^{\circ}\text{C } 20.0\%]$ , with SISO and MISO PID, with SISO and MISO MPC, each case with uncertainties: 1.68% error on the initial moisture concentration and 10.0% error on the diffusion coefficient*

<i>RMSE (%)</i>	<i>SISO</i>	<i>MISO</i>
<i>Open loop 1 (<math>u=u_0=[49.5^{\circ}\text{C } 10.0\%]</math>)</i>	—	4.36
<i>Open loop 2 (<math>u=u_0=[45.0^{\circ}\text{C } 20.0\%]</math>)</i>	—	4.12
<i>PID</i>	2.08	1.98
<i>MPC</i>	0.34	0.29

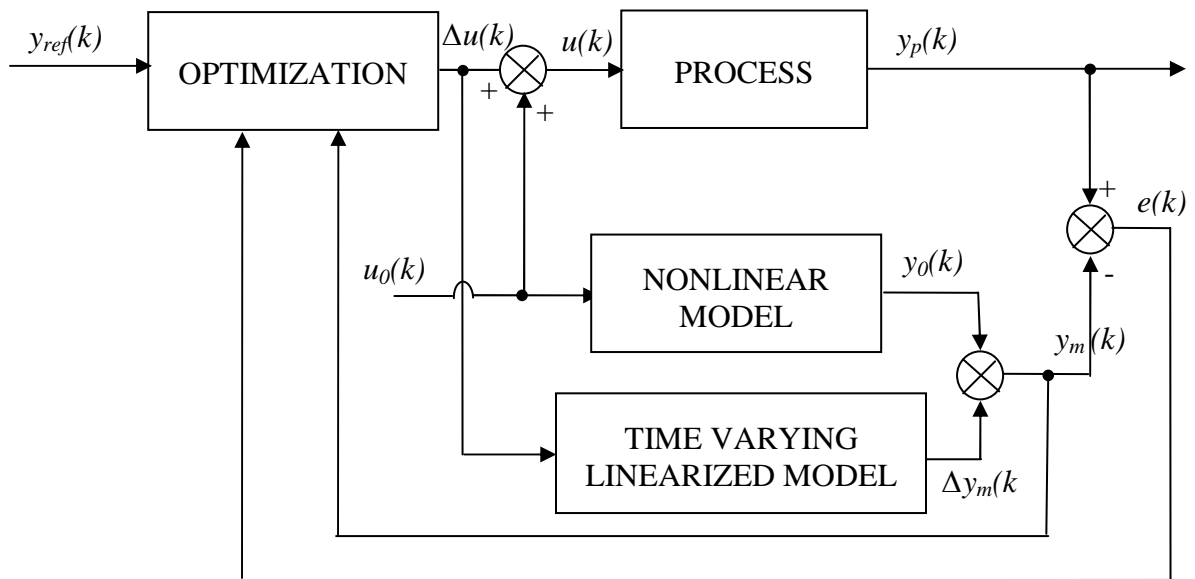

Fig. 1: General MPC structure used.

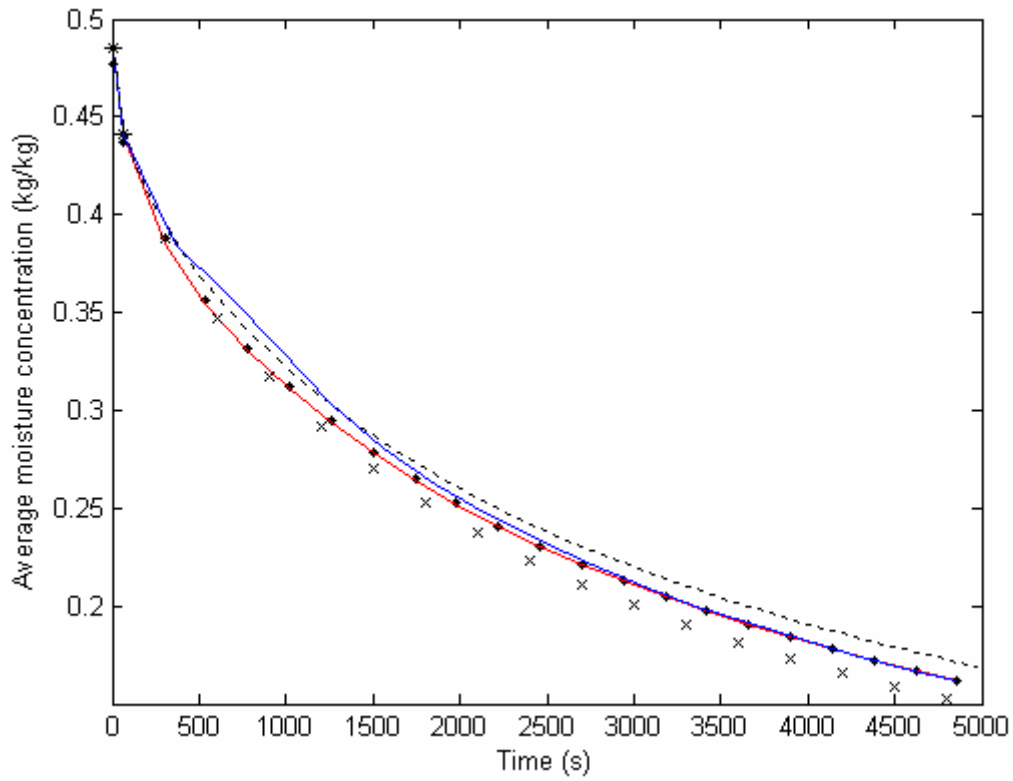
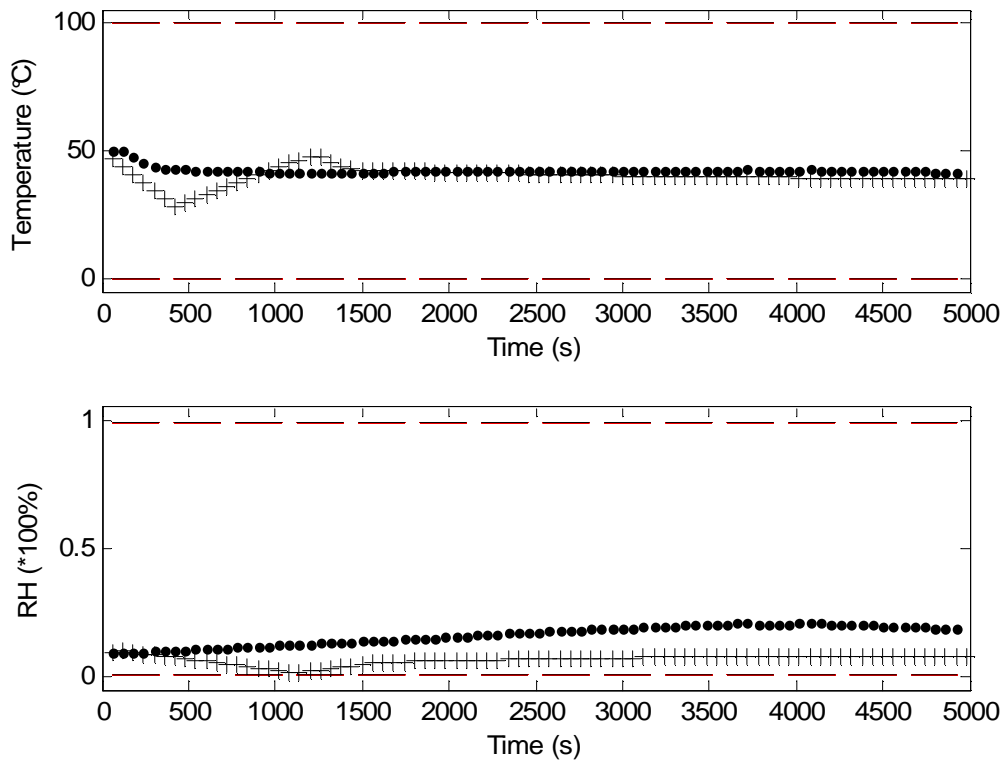
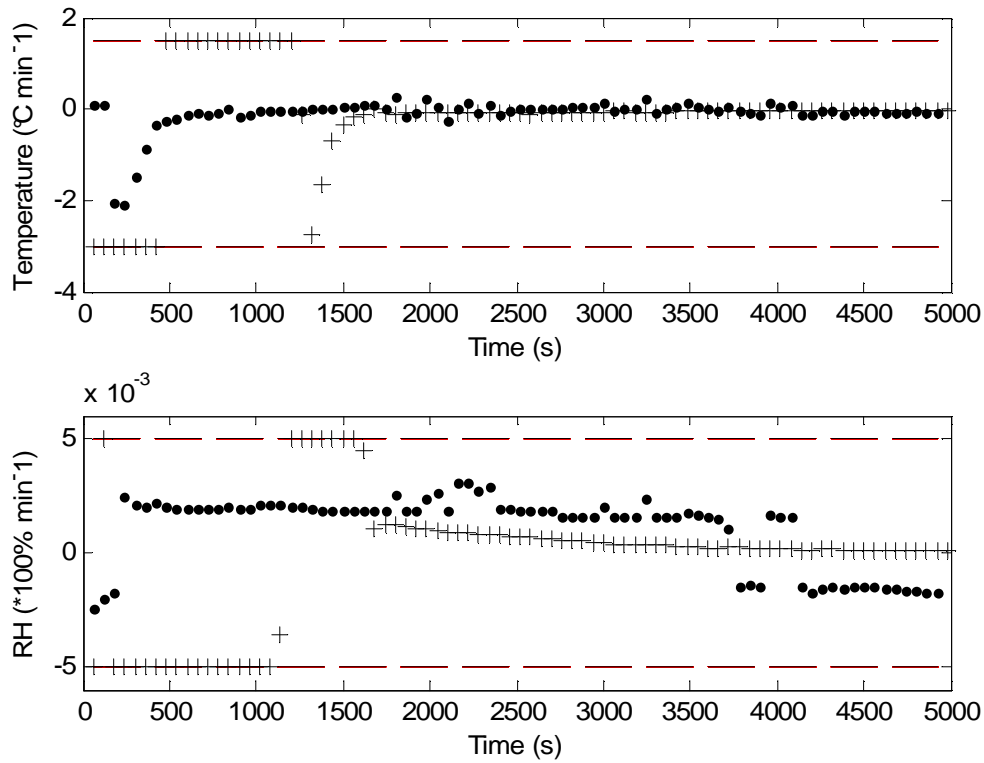

Fig. 2: Reference trajectory tracking: reference curve (•••) for the drying process output: with open loop control while  $u=u_0=[49.5^\circ\text{C } 10.0\%]$  (x) and  $u=u_0=[45.0^\circ\text{C } 20.0\%]$  (- - -), with the MISO PID (—) and with the MISO MPC (—) with a 5 point horizon prediction, each case with uncertainties: 1.68% error on the initial moisture concentration and 10.0% error on the diffusion coefficient.



*Fig. 3: Constrained manipulated variable magnitude: minimal and maximal allowed temperature and relative humidity magnitude (---) together with the actual temperature and relative humidity for the MISO PID (+++) and the MISO MPC (•••) with a 5 point horizon prediction, each case with uncertainties: 1.68% error on the initial moisture concentration and 10.0% error on the diffusion coefficient.*



*Fig. 4: Variation in constrained manipulated variable magnitudes: minimal and maximal allowed temperature and relative humidity variation (---) together with the actual variation in temperature and relative humidity between the successive sampling instants for the MISO PID (+++) and the MISO MPC (•••) with a 5 point horizon prediction, each case with uncertainties: 1.68% error on the initial moisture concentration and 10.0% error on the diffusion coefficient.*

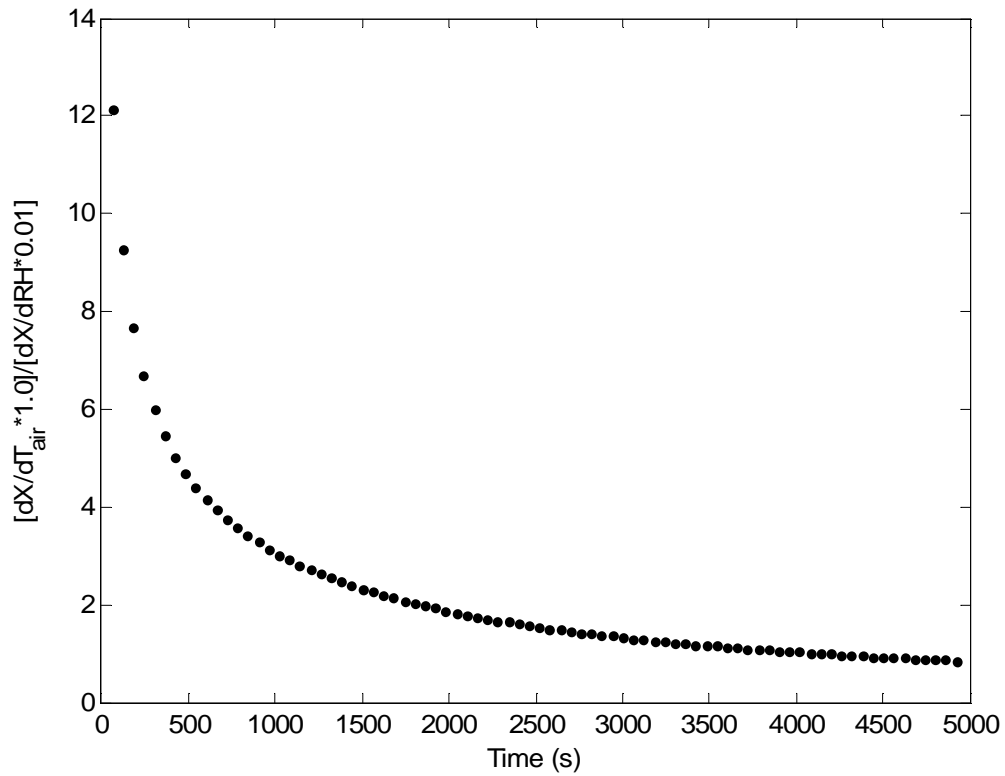

*Fig. 5: The ratio between the sensitivities of the air temperature and mean relative humidity with respect to an air temperature input of 1.0°C and with respect to a relative humidity input of 1.0%, measured for the drying process at 49.5°C and 10.0%.*

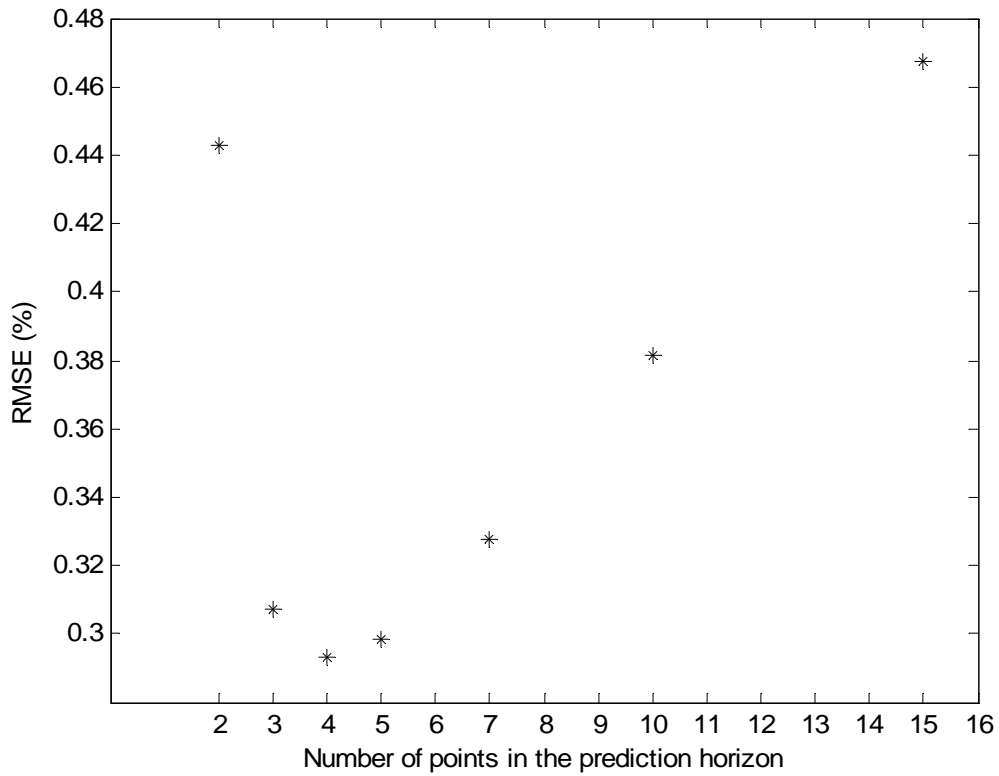

*Fig. 6: The impact of the tuning of the prediction horizon of the MPC on the RMSE, each case with uncertainties: 1.68% error on the initial moisture concentration and 10.0% error on the diffusion coefficient.*

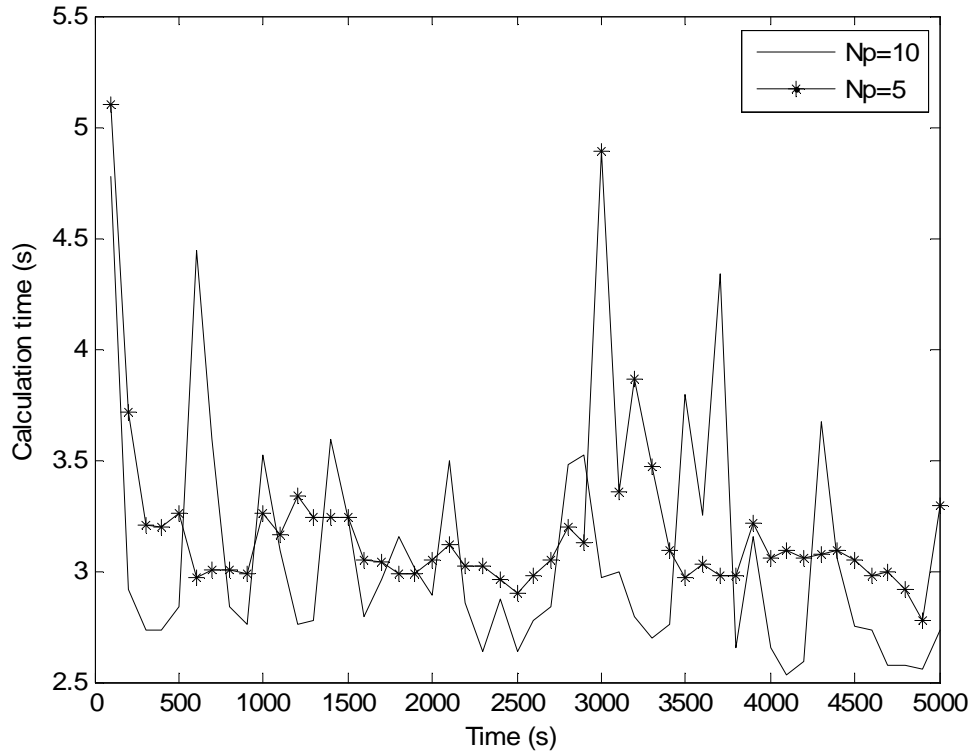

*Fig. 7: Time needed by the whole program to compute the control action by the MPC, evaluated for prediction horizons of 5 (—) and 10 (—\*—) points, each case with uncertainties: 1.68% error on the initial moisture concentration and 10.0% error on the diffusion coefficient.*