



**HAL**  
open science

## High-Q Quartz Crystal Oscillators Analysis by a 5-Terminal Network Method

Nicolas Ratier, Rémi Brendel

► **To cite this version:**

Nicolas Ratier, Rémi Brendel. High-Q Quartz Crystal Oscillators Analysis by a 5-Terminal Network Method. 9th WSEAS International Conference on Mathematical Methods and Computational Techniques in Electrical Engineering, Oct 2007, Arcachon, France. pp.571-176. hal-00345274

**HAL Id: hal-00345274**

**<https://hal.science/hal-00345274>**

Submitted on 8 Dec 2008

**HAL** is a multi-disciplinary open access archive for the deposit and dissemination of scientific research documents, whether they are published or not. The documents may come from teaching and research institutions in France or abroad, or from public or private research centers.

L'archive ouverte pluridisciplinaire **HAL**, est destinée au dépôt et à la diffusion de documents scientifiques de niveau recherche, publiés ou non, émanant des établissements d'enseignement et de recherche français ou étrangers, des laboratoires publics ou privés.

# High-Q Quartz Crystal Oscillators Analysis by a 5-Terminal Network Method

NICOLAS RATIER

Institut FEMTO-ST, CNRS UMR 6174  
Département LPMO  
32 av. de l'Observatoire, 25044 Besançon  
FRANCE  
nicolas.ratier@femto-st.fr

REMI BRENDEL

Institut FEMTO-ST, CNRS UMR 6174  
Département LPMO  
32 av. de l'Observatoire, 25044 Besançon  
FRANCE  
remi.brendel@femto-st.fr

*Abstract:* A straightforward method to simulate high-Q quartz crystal oscillator is derived in this paper. The oscillator circuit is expressed under a canonical 5-terminal network which can be easily handled. The oscillator behavior is then described under the form of a nonlinear characteristic polynomial whose coefficients are functions of the circuit components and of the oscillation amplitude. The steady state oscillation amplitude and frequency are determined by solving the polynomial in the frequency domain.

*Key-Words:* Quartz Crystal Oscillator, Nonlinear, Simulation, Characteristic Polynomial,  $n$ -Terminal Network

## Introduction

We have developed [9][10][2][3][4] a symbolic-numeric method to simulate high-Q quartz crystal oscillator. This method is based on rewriting the amplifier part of the oscillator under a reduced form. To obtain this reduced form, the transistor is replaced by an equivalent admittance circuit, then each component of the circuit is progressively integrated into this equivalent circuit. Finally, the oscillation condition can be easily stated.

Although this method gives accurate simulation results, it has two drawbacks. The first one is the number of equations to manage, indeed, at each step of the reduction, the relations between both equivalent circuits have to be saved. The second problem is that we are not sure that every oscillator circuit can be analysed by this method.

The work described here was initiated to overcome these problems while saving the efficiency of our initial method. The oscillator is now separated into 3 parts (Fig. 1): the quartz crystal resonator, the active component (transistor) and a 5-terminal network which links the two previous elements.

The paper is organized as follow: we first recall the standard equivalent circuit of the resonator and define a large signal equivalent circuit for the transistor. Next, we show that the network  $N$  can always be expressed under a canonical form. Thus, the transformation in the so-called reduced form of an oscillator becomes straightforward. The oscillation condition and characteristic polynomial are then obtained, which lead eventually to the equation system which

represents the oscillator behavior with respect to all circuit components.

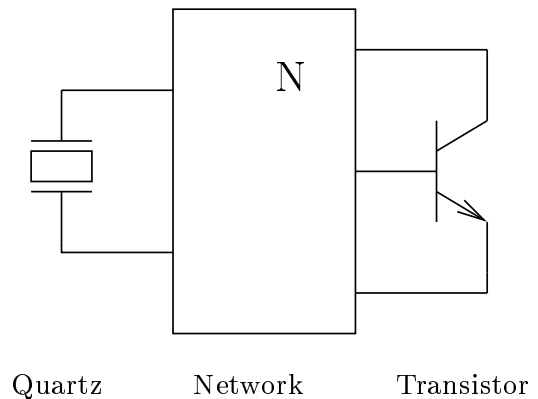

Figure 1: 5-terminal representation of a quartz crystal oscillator.

## 1 Resonator equivalent circuit

The classical equivalent circuit of a quartz crystal resonator is shown in Fig. 2 [5][6]. It comprises a motional arm ( $R_q, L_q, C_q$ ) in parallel with a capacitance ( $C_p$ ). The resonator behavior is characterized by the series resonant frequency  $f_q$ , the inductance  $L_q$ , the series resistance  $R_q$ , and the parallel capacitance  $C_p$ .

Some high precision simulation needs to take into account the isochronism defect of the quartz crystal resonator. In that case, the actual resonant frequency

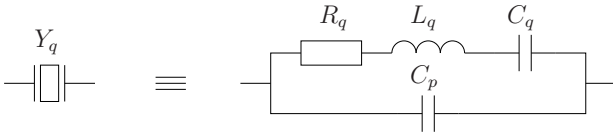

Figure 2: Equivalent circuit of the resonator.

$f'_q$  depends on the drive level [7] according to the law:

$$f'_q = f_q (1 + aP_a) \quad (1)$$

$$P_a = \text{Re} \{ Z_q \} \langle i_q^2 \rangle \quad (2)$$

where  $P_a$  is the active power within the crystal,  $a$  is the isochronism effect parameter of first order and  $\langle i_q^2 \rangle$  is the mean square value of the current through the crystal. The capacitance  $C_q$  has to be replaced by  $C'_q$  which is calculated from  $f'_q$  and  $L_q$  (Eq. 3).

$$C'_q = \frac{1}{4\pi^2 L_q f_q'^2} \quad (3)$$

## 2 Transistor equivalent circuit

The transistor is modelled [6] by a large signal admittance parameter circuit (Fig. 3). The 4 admittances  $y_i$ ,  $y_r$ ,  $y_f$  and  $y_o$  enable to modelize accurately the non-linear behavior of the component.

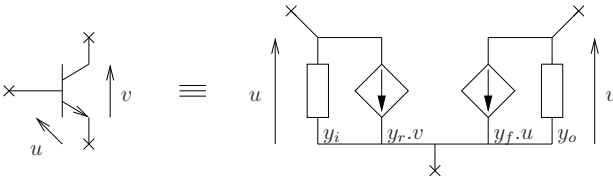

Figure 3:  $y$ -parameter representation of a transistor.

From their definition, it results that  $y_i$  and  $y_f$  depend on the input voltage  $u$  while  $y_r$  and  $y_o$  depend on the output voltage  $v$  (4)–(7). The 8 functions  $g_\bullet$  and  $c_\bullet$  are calculated [1] for a given bias and temperature conditions by using the electrical simulator SPICE [11]. They can be represented under the form of a table or computed at run time.

$$y_i(|u|) = g_i(|u|) + s c_i(|u|) \quad (4)$$

$$y_r(|v|) = g_r(|v|) + s c_r(|v|) \quad (5)$$

$$y_f(|u|) = g_f(|u|) + s c_f(|u|) \quad (6)$$

$$y_o(|v|) = g_o(|v|) + s c_o(|v|) \quad (7)$$

## 3 Processing of the 5-terminal network

The theory of network circuits proves that any  $n$ -terminal passive network can be represented by  $n(n-1)/2$  admittances connected between each  $n$  terminal nodes. An example is given in Fig. 4 for some  $n$ -terminal networks.

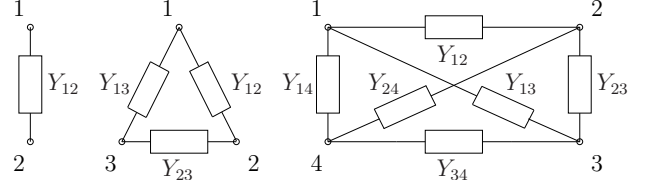

Figure 4: Representation of some  $n$ -terminal networks.

It can be shown [12] that the  $n(n-1)/2$  admittances  $Y_{kl}$  ( $k \neq l$ ) can be computed using the following formula:

$$Y_{kl} = \frac{1}{2} (S_k + S_l - S_{kl}) \quad (8)$$

The admittance  $S_k$  is the driving-point admittance when all the terminals except  $k$  are shorted and when a voltage is applied to terminal  $k$ . These conditions are represented in Fig. 5 on a 5-terminal network for  $k = 2$ .

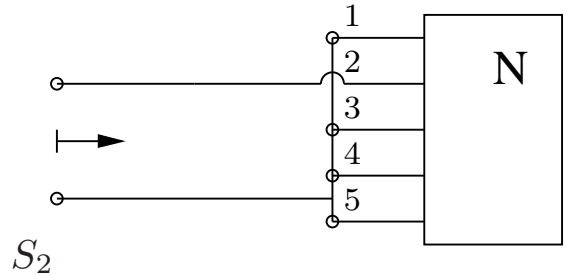

Figure 5: Computation or measurement of the admittance  $S_k$ .

The admittance  $S_{kl}$  is the driving-point admittance when all the terminals except  $k$  and  $l$  are shorted and when the same voltage is applied to terminals  $k$  and  $l$ . These conditions are represented in Fig. 6 on a 5-terminal network for  $k = 2$  and  $l = 4$ .

The computation of the driving-point admittances  $S_k$ ,  $S_l$  and  $S_{kl}$  is straightforward by using topological methods. The common feature of these methods is that the network is represented by a graph that

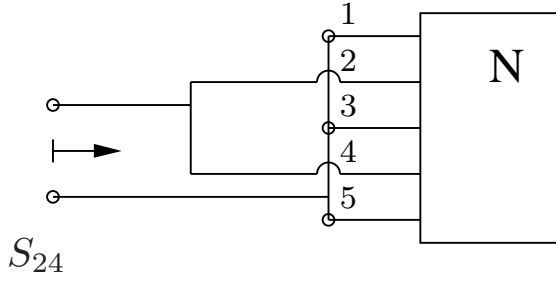

Figure 6: Computation or measurement of the admittance  $S_{kl}$ .

resembles the network, and the calculation of any network function is transformed into a subgraph enumeration problem.

We recall some graph theory definitions: A tree  $T$  of a graph  $G$  is a subgraph of  $G$  if  $T$  is connected, if  $T$  contains all nodes of  $G$  and if  $T$  has no loops. A tree-admittance product of  $N$  is the product of the admittances of a tree of  $N$ .

The driving-point admittance of an RLC network  $N$  is given [8] by (9) where  $N^*$  is derived from  $N$  by short-circuiting the two input terminals, and then removing any short-circuited branches.

$$Y = \frac{\text{sum of all tree-admittance products of } N}{\text{sum of all tree-admittance products of } N^*} \quad (9)$$

It is clear that the calculus of the sum of all tree-admittance products is a disguised method to compute the determinant of a node admittance matrix. As opposed to regular algebraic method to inverse the linear equation system of node admittances, the final answer of the determinant is here directly written down, *i.e.* without cancellation of terms.

## 4 Reduced form of the amplifier

We have shown that the network  $N$  and the transistor part of an oscillator can always be represented as in Fig. 7. The network is replaced by the  $5 \times (5 - 1)/2 = 10$  equivalent admittances  $Y_1, Y_2, \dots, Y_{10}$ , and the transistor is substituted by grayed admittances  $y_i, y_r, y_f$  and  $y_o$ .

The canonical circuit in Fig. 7 can be transformed into the reduced form shown in Fig. 8. Under this form, the computation of the oscillation condition becomes trivial. We shall express the new coefficients  $Y_i, Y_r, Y_f$  and  $Y_o$  as functions of the transistor admittances  $y_i, y_r, y_f, y_o$  and of the network admittances.

The relation between the voltages  $(u, v)$  across the transistor and the voltages  $(U, V)$  across the res-

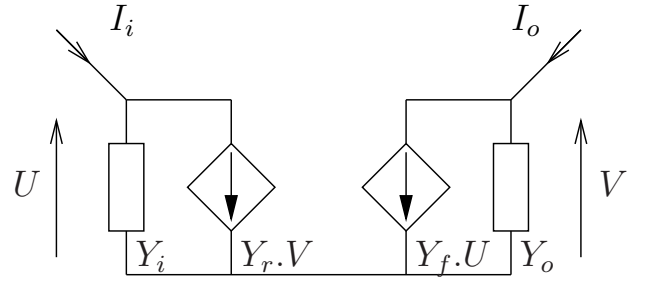

Figure 8: Reduced form of the amplifier.

onator is calculated by writing nodal equations at nodes 1 and 2. This leads to (10),

$$\begin{pmatrix} u \\ v \end{pmatrix} = \begin{pmatrix} C_{11} & C_{12} \\ C_{21} & C_{22} \end{pmatrix} \begin{pmatrix} U \\ V \end{pmatrix} \quad (10)$$

with the following coefficients:

$$\Delta = A_{11}A_{22} - A_{12}A_{21} \quad (11)$$

$$C_{11} = (A_{22}Y_3 - A_{12}Y_5) / \Delta \quad (12)$$

$$C_{12} = (A_{22}Y_4 - A_{12}Y_6) / \Delta \quad (13)$$

$$C_{21} = (A_{11}Y_5 - A_{21}Y_3) / \Delta \quad (14)$$

$$C_{22} = (A_{11}Y_6 - A_{21}Y_4) / \Delta \quad (15)$$

The inverse of Eq. 10 is given here because it will be used into the oscillation condition derivation section. From the same nodal equations at nodes 1 and 2, or by inverting (10), one can obtain:

$$\begin{pmatrix} U \\ V \end{pmatrix} = \begin{pmatrix} B_{11} & B_{12} \\ B_{21} & B_{22} \end{pmatrix} \begin{pmatrix} u \\ v \end{pmatrix} \quad (16)$$

with the following coefficients:

$$\delta = Y_3Y_6 - Y_5Y_4 \quad (17)$$

$$B_{11} = (Y_6A_{11} - Y_4A_{21}) / \delta \quad (18)$$

$$B_{12} = (Y_6A_{12} - Y_4A_{22}) / \delta \quad (19)$$

$$B_{21} = (Y_3A_{21} - Y_5A_{11}) / \delta \quad (20)$$

$$B_{22} = (Y_3A_{22} - Y_5A_{12}) / \delta \quad (21)$$

The coefficients  $A_{ij}$  are defined in both cases by the following equations (Eq. 22–25).

$$A_{11} = Y_8 + y_i + Y_3 + Y_4 + Y_9 \quad (22)$$

$$A_{12} = y_r - Y_9 \quad (23)$$

$$A_{21} = y_f - Y_9 \quad (24)$$

$$A_{22} = Y_{10} + y_o + Y_6 + Y_5 + Y_9 \quad (25)$$

By writing nodal equation at nodes 3 and 4, replacing the voltages  $(u, v)$  by their expressions as a fonction

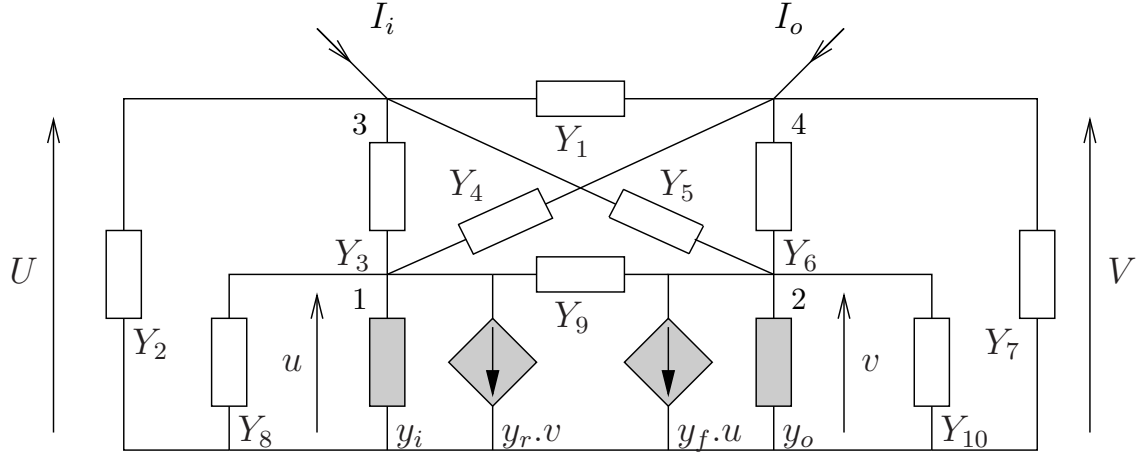

Figure 7: Canonical form of the amplifier.

of  $(U, V)$ , and finally equating with node equations of Fig. 8, one can express the relation between the amplifier admittances  $(Y_i, Y_r, Y_f, Y_o)$  and the transistor admittances  $(y_i, y_r, y_f, y_o)$ .

$$Y_i = Y_1 + Y_2 + Y_3(1 - C_{11}) + Y_5(1 - C_{21}) \quad (26)$$

$$Y_r = -Y_1 - Y_3C_{12} - Y_5C_{22} \quad (27)$$

$$Y_f = -Y_1 - Y_6C_{21} - Y_4C_{11} \quad (28)$$

$$Y_o = Y_1 + Y_7 + Y_6(1 - C_{22}) + Y_4(1 - C_{12}) \quad (29)$$

## 5 Oscillation condition derivation

We have shown that the circuit of a quartz crystal oscillator can be represented as shown in Fig. 9. The resonator is connected across the amplifier part of the oscillator which is itself composed of the network  $N$  and the transistor.

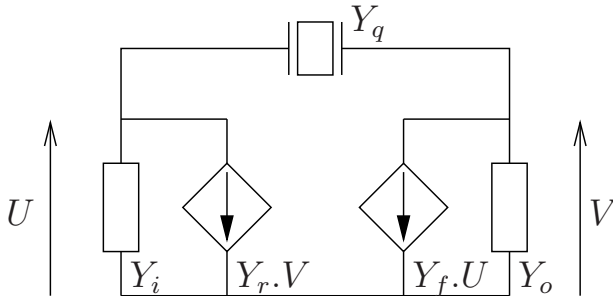

Figure 9: Reduced form of the oscillator.

Under this reduced form, the derivation of the oscillation condition is straightforward. The application of Kirchhoff's law at both input and output parts of the

circuit (Fig. 9) leads to the following relations (30)–(31).

$$(Y_i + Y_q)U + (Y_r - Y_q)V = 0 \quad (30)$$

$$(Y_f - Y_q)U + (Y_o + Y_q)V = 0 \quad (31)$$

### 5.1 Gain of the transistor

The system (30) and (31) gives two ways to compute the gain of the transistor (ratio  $v/u$ ). By replacing into these equations the voltage  $(U, V)$  as a function of  $(u, v)$  (Eq. 16), the voltage  $v$  is expressed as a function of the voltage  $u$ . Obviously, these two equations must give the same result.

$$\frac{v}{u} = -\frac{B_{11}(Y_i + Y_q) + B_{21}(Y_r - Y_q)}{B_{12}(Y_i + Y_q) + B_{22}(Y_r - Y_q)} \quad (32)$$

$$\frac{v}{u} = -\frac{B_{11}(Y_f - Y_q) + B_{21}(Y_o + Y_q)}{B_{12}(Y_f - Y_q) + B_{22}(Y_o + Y_q)} \quad (33)$$

### 5.2 Oscillator characteristic polynomial

The system (30) and (31) admits a nontrivial solution only if its determinant is null, this gives the oscillation condition of the circuit (34). The admittances  $Y_i, Y_r, Y_f$  and  $Y_o$  are functions of the circuit components (inside the network  $N$ ) and of the transistor representative components (conductances  $g_\bullet$  and capacitances  $c_\bullet$ ). The admittance  $Y_q$  is expressed by its equivalent circuit ( $R_q, L_q, C_q$  and  $C_p$ ).

$$Y_i Y_o - Y_f Y_r + (Y_i + Y_r + Y_f + Y_o) Y_q = 0 \quad (34)$$

Replacing the admittances by their expressions, which are rational functions in the Laplace's variable  $s$ , leads to the oscillator characteristic polynomial (35). Each coefficient  $a_k$  of this polynomial is expressed as a

function of the component value of the circuit. The degree  $K$  of the characteristic polynomial depends on the component number and on the topology of the network  $N$ .

$$\sum_{k=0}^K a_k s^k = 0 \quad (35)$$

To obtain the steady state frequency and amplitude of the oscillation, the Laplace's variable  $s$  is replaced by the harmonic variable  $j\omega$ , this splits (35) into real and imaginary part. One of the two equations 32 or 33 must be added to compute the voltage  $v$  as a function of  $u$ .

$$\sum_{k=0}^K \alpha_k (u, v) \omega^k = 0 \quad (36)$$

$$\sum_{k=0}^K \beta_k (u, v) \omega^k = 0 \quad (37)$$

$$\frac{B_{11} (Y_i + Y_q) + B_{21} (Y_r - Y_q)}{B_{12} (Y_i + Y_q) + B_{22} (Y_r - Y_q)} = \frac{v}{u} \quad (38)$$

The numerical calculation of the variables  $u$ ,  $v$  and  $\omega$  which satisfies the system (36)–(38) determines the frequency and the amplitude of the oscillation. The numerical computation is independent of the time constants of the circuit. If the designer would evidence relative frequency changes of about  $\Delta f/f \simeq 10^{-6}$ , the isochronism defect of the resonator can be taken account by modifying its equivalent circuit.

## 6 Conclusion

The core of the analysis of an oscillator circuit is done by computing the 10 equivalent admittances of the canonical form described here, and by simulating the 4 equivalent admittances of the transistor. All the other computations are common to all oscillator circuits with one transistor and can be thus coded once for all.

The characteristic polynomial coefficients are expressed as functions of all circuit components. Therefore, the influence of a change of any component value on the oscillation amplitude and frequency as well as on the resonator excitation level can be directly calculated.

In addition, if tolerance and temperature coefficient are assigned to each component, our method can be used to perform efficient worst case analysis and to simulate the signal sensitivity at a given temperature with respect to every circuit component.

## References:

- [1] R. Brendel, F. Djian, and E. Robert. High precision nonlinear computer modelling technique for quartz crystal oscillators. In *Proc. of the 45th Annual Symposium on Frequency Control (AFCS)*, pages 341–351, Los Angeles, California, May 29-31 1991.
- [2] R. Brendel, N. Ratier, L. Couteleau, G. Marianneau, and P. Guillemot. Slowly varying function method applied to quartz crystal oscillator transient calculation. *IEEE Trans. on Ultrasonics, Ferroelectrics and Frequency Control*, 45(2):520–527, March 1998.
- [3] R. Brendel, N. Ratier, L. Couteleau, G. Marianneau, and P. Guillemot. Analysis of Noise in Quartz Crystal Oscillators by Using Slowly Varying Functions Method. *IEEE Trans. on Ultrasonics, Ferroelectrics and Frequency Control*, 46(2):356–365, March 1999.
- [4] L. Couteleau, R. Brendel, N. Ratier, and P. Guillemot. Analysis of Parametric Noise in Quartz Crystal Oscillators. In *Joint Meeting of the 13th European Frequency and Time Forum and the 1999 IEEE International Frequency Control Symposium*, pages 518–521, Besançon, France, April 13-16 1999.
- [5] Van Dyke. The electric network equivalent of a piezoelectric resonator. *Phys. Rev.*, 25:895, 1925.
- [6] M.E. Frerking. *Crystal Oscillator Design and Temperature Compensation*. New York: Van Nostrand Reinhold, 1978.
- [7] J.-J. Gagnepain and R. Besson. Nonlinear effect in piezoelectric quartz crystals. *Physical Acoustics*, XI:266–278, 1975.
- [8] P.M. Lin. *Symbolic Network Analysis*. Elsevier, New York, 1991.
- [9] N. Ratier, R. Brendel, and P. Guillemot. Quartz oscillators: deriving oscillation condition by symbolic calculus. In *Proc. of the Tenth European Frequency and Time Forum*, pages 442–446, Brighton, United Kingdom, March 5-7 1996.
- [10] N. Ratier, L. Couteleau, R. Brendel, and P. Guillemot. Automatic formal derivation of the oscillation condition. In *International Frequency Control Symposium (IEEE)*, pages 925–931, Orlando, Florida, May 28-30 1997.
- [11] Steven M. Sandler and Charles Hymowitz. *SPICE Circuit Handbook*. McGraw-Hill Professional, 2006.
- [12] Louis Weinberg. *Network Analysis and Synthesis*. Krieger Publishing Company, second edition, 1975.