



**HAL**  
open science

## **Component Reliability in Fault Diagnosis Decision-Making based on Dynamic Bayesian Networks**

Philippe Weber, Didier Theilliol, Christophe Aubrun

► **To cite this version:**

Philippe Weber, Didier Theilliol, Christophe Aubrun. Component Reliability in Fault Diagnosis Decision-Making based on Dynamic Bayesian Networks. Proceedings of the Institution of Mechanical Engineers, Part O: Journal of Risk and Reliability, 2008, 222 (2), pp.161-172. <10.1243/1748006XJRR96>. <hal-00340373>

**HAL Id: hal-00340373**

**<https://hal.science/hal-00340373v1>**

Submitted on 20 Nov 2008

HAL is a multi-disciplinary open access archive for the deposit and dissemination of scientific research documents, whether they are published or not. The documents may come from teaching and research institutions in France or abroad, or from public or private research centers.

L'archive ouverte pluridisciplinaire HAL, est destinée au dépôt et à la diffusion de documents scientifiques de niveau recherche, publiés ou non, émanant des établissements d'enseignement et de recherche français ou étrangers, des laboratoires publics ou privés.



HAL Authorization

# Component Reliability in Fault Diagnosis Decision-Making based on Dynamic Bayesian Networks

Philippe WEBER, Didier THEILLIOL, Christophe AUBRUN

*Centre de Recherche en Automatique de Nancy - CNRS UMR 7039 - Nancy Université  
Faculté des Sciences et Techniques - BP 239 - 54506 Vandoeuvre Cedex France  
Phone: +33 383 684 465 - Fax: +33 383 684 462  
[philippe.weber,didier.theilliol,christophe.aubrun@cran.uhp-nancy.fr](mailto:philippe.weber,didier.theilliol,christophe.aubrun@cran.uhp-nancy.fr)*

**Abstract:** The decision-making in fault diagnosis methods generally relies on the analysis of fault signature vectors. This paper presents a new approach of decision-making in the case of the signature vectors for various identical or similar faults. The main contribution of the paper consists in the fusion between the reliability and the evaluation of the residuals in order to increase the fault isolation efficiency. The decision-making, formalised as a bayesian network, is established with a priori knowledge on fault signatures, false alarm and missing detection probability, on line component state estimation computed by a bayesian fusion of the component reliability and measurements. The effectiveness and performances of the method are illustrated on a heating water process corrupted by various faults.

**Keywords:** Model-based fault diagnosis, Bayesian Networks, Reliability, Markov chains, Decision-making.

## 1. INTRODUCTION

Modern control systems are becoming more and more complex. Consequently, there is a growing demand for fault diagnosis to increase the reliability of such systems. In this context, fault diagnosis domain has gained increasing consideration. A fault is considered as malfunction in the actual system that tends to degrade the overall system performances. In this paper, our attention is focused on model-based fault diagnosis which makes use of the analytical relationships between measured variables. A short historical survey on fault diagnosis can be found in [1] and various approaches have been reported in [2]. The fault diagnosis procedure consists in three stages:

- Residuals generation: it consists in associating a model-observation pair to evaluate difference with respect to the normal operating conditions;
- Residuals evaluation: the residuals are compared to some predefined threshold according to a test and, at this stage, symptoms are produced;
- Decision making: the role of the decision making is to decide according to the symptoms, which elements are faulty, that is isolation.

This requires the design of residuals that are close to zero in the fault-free situations while clearly deviating from zero in the presence of faults. These residuals possess the ability to discriminate between all possible modes of faults, which explain the use of the term decision-making. Classically, decision-making is realized according to an elementary logic. Nevertheless, when multiple faults or false alarms occur, the faults cannot be isolated [3]. Some specific mathematics algorithms can improve the efficiency of the decision-making, for instance:

- [4], [5], have proposed methods which increase the robustness of residual by decoupling the effects of faults from each other and from the modelling errors and uncertainties.
- [6] have developed a method based on adaptive threshold approach to reduce the sensitivity of the residuals evaluation against false alarms.

However, in any case, the binary data produced by residuals evaluation are poor in information. Moreover, the degree of isolability based on Hamming distance as suggested [7] is very low. Consequently, some other knowledge related to the residuals should be considered for isolation. [8] and [9] have combined qualitative and quantitative knowledge to improve the fault diagnosis efficiency. In the spirit of [10], fault isolation performance may be increased by integrating extra information in the diagnosis process. Thus, reliability, classically computed by means of stochastic process model as Markov Chains (MC), defines the *a priori* behavior of the probability distribution over the nominal states and faulty states of the system. Also, this additional information is seldom used to improve decision-making in model-based fault diagnosis [11].

The aim of the paper is to propose a new approach which increases the performance of the decision-making in fault diagnosis by taking into account a priori knowledge on the system state through a dynamic Bayesian network.

The paper is organized as follows: Section 2 presents the principle of the decision-making in model-based fault diagnosis and fault isolation problem is stated. Section 3 describes the method which achieves the decision-making based on the Bayesian network (BN) inference. Then, the proposed approach used to merge both the fault diagnosis and the dynamic reliability is presented. The proposed approach is illustrated through a simulation example in Section 4. Finally, conclusions and perspectives are given in last Section.

## 2. PROBLEM STATEMENT

### 2.1 Symptoms generation

The first step produces indicators sensitive to the faults. These indicators are defined as Residuals, noted “ $r$ ”. A residual is defined as the difference between a measurement and the corresponding reference value estimated with a model of the fault-free system (Figure 1).

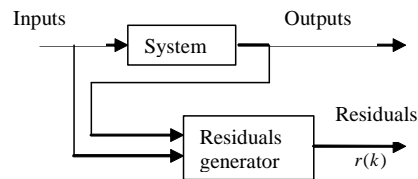

Figure 1: Illustration of residual generator.

While a single residual is sufficient to detect a fault, a set of residuals is required for fault isolation. Several methods have been proposed in the literature to generate structured residuals and to perform the fault diagnosis [1]. One of the most popular is the observer-based design [12], [13]. The causal knowledge-based addressed in [14] deals with the complexity of large scale systems. Another way to generate structured residuals is to develop models having an appropriate structure. The structured residuals may be generated by parity equations from the input-output model, or balance equations (*chap. 6 and 9, [4]*). The objective is to decouple the faulty effects from each residual. Each residual is designed so that it is sensitive to different faults or subsets of faults.

Usually, the second step of the diagnostic procedure, *Residuals* evaluation, is based on the assumption that if a fault occurs, the statistical characteristic of the residuals is modified. The residuals evaluation involves statistical testing such as limit checking test, generalized likelihood ratio test, trend analysis test. The output vector of the

statistical test, called coherence vector  $U$ , can be built according to a test applied to the set of  $J$  residuals:  $U = [u_1, \dots, u_j, \dots, u_J]^T$  where  $u_j$  represents the status of the residuals:  $u_j$  is equal to “0” when the residual signal is closed to zero in some sense and equal to “1” otherwise.  $u_j$  is called the symptom associated to the residual  $r_j$ .

Unfortunately, the residual is corrupted by noise, which affects the decision-making. The efficiency of the detection is related to the false alarm and missing detection probability. In the residual evaluation, the problem may be formulated as a hypotheses testing problem. Let us recall the main definition:

- $H_0$  : the residual is not affected by a fault;
- $H_1$  : the residual is corrupted by fault.

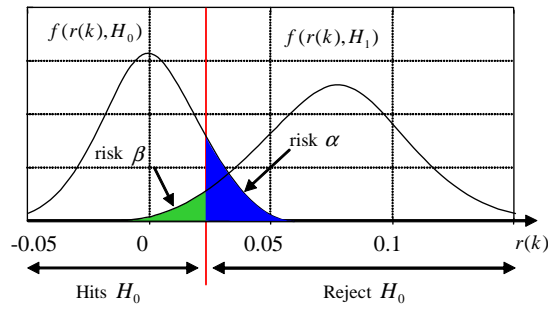

Figure 2: Illustration of the error of the first kind  $\alpha$  and error of the second kind  $\beta$ .

Figure 2 gives an illustration of hypotheses testing problem with Gaussian density functions. The density functions  $f(r(k), H_0)$  and  $f(r(k), H_1)$  characterize the probability that the residual  $r(k)$  respect the hypothesis  $H_0$  or  $H_1$ . The surfaces representing the probability of false alarm correspond to the risk  $\alpha$  defining as the conditional probability:

$$\alpha = p(\text{reject } H_0 | H_0 \text{ is true}) \quad (1)$$

and the probability of missing detection correspond to the surface risk  $\beta$  defining the conditional probability:

$$\beta = p(\text{not reject } H_0 | H_1 \text{ is true}) \quad (2)$$

More details can be found in the reference book of Basseville and Nikiforov [15] or in the second chapter of the book of Young and Calvert [16].

The risk values  $\alpha$  and  $\beta$  are calculated *a priori* if the density functions  $f(r(k), H_i)$  are known. However, this is rarely the case in practice. If the density functions are not available, then an estimation of the probabilities is computed by mean of a *frequentist* approach based on data including *a posteriori* detection results.

## 2.2 Incidence matrix

Several approaches have been proposed to generate structured residuals and consequently to generate the incidence matrix [12]. Let us consider the following example where three different faults ( $F_1$ ,  $F_2$  and  $F_3$ ) can be isolated by designing three symptoms  $u_1$ ,  $u_2$  and  $u_3$  (Table 1).

Table 1: Incidence matrix example.

	$F_1$	$F_2$	$F_3$
$u_1$	0	1	0
$u_2$	1	0	0
$u_3$	1	0	1

In Table 1, a "1" denotes that a symptom  $u_j$  is sensitive to a fault ( $F_1$ ,  $F_2$  or  $F_3$ ), while a "0" denotes insensitivity to a fault. This table is called an incidence matrix and can be considered as an *a priori* knowledge. Each column of the incidence matrix represents a fault signature: the vector  $[0 \ 1 \ 1]^T$  corresponds to the signature of the faulty element  $F_1$ . In this paper, incidence matrix is annotated  $D$  with different elements  $D(n,j)$ , where  $n$  is the number of elements suspected to be faulty ( $n=1\dots N$ ) and  $j$  is the number of residuals ( $j=1\dots J$ ).

### 2.3 Fault Isolation

Usually, a very simple logic analysis between each fault signature  $F_n$  and each coherence vector  $U$  is used to isolate the faulty component. In practical cases, false alarms occur and corrupt the decision logic. The coherence vector can be different from all signatures. Therefore, the goal of the decision-making is to minimize the false alarms and missing detection rates due to the effects of modelling errors and unknown disturbances that affect residuals.

Moreover, in spite of the residuals generation and evaluation robustness, a simple logic rule is not efficient enough to isolate faults when simultaneous multiple faults occur [17]. This is justified by the fact that if  $D(n,j)=0$ , then  $u_j$  cannot bring any information about the occurrence of fault  $F_n$ , since the residual  $r_j$  might be different from 0 due to noise or modelling errors or another fault  $F_k$  (with  $D(k,j)=1$ ) affecting the system. Thus, new decision-making method is necessary.

Moreover, a new source of information should be integrated in fault diagnosis. [18] has-recently proposed to introduce reliability analysis for fault diagnosis purpose. System reliability analysis allows determining the degradation degree of the system components. The paper aims at developing a method which integrates a dynamic reliability estimation of the system component as presented in the next section. In this new approach the reliability of the components is computed according to the states of the residuals (with the bayesian approach) and not only an *a priori* estimation of the reliability. This is the reason why a dynamic computation of the reliability is used.

## 3. DECISION-MAKING PROCESS DESIGN

### 3.1 Bayesian network equivalent to incidence matrix

#### a) Bayesian network (BN):

Bayesian network are probabilistic networks based on graph theory. They are directed acyclic graphs used to represent uncertain knowledge in Artificial Intelligence [19]. Each node represents a discrete variable defined

over several states and the arcs indicate direct probabilistic relations between the nodes. A discrete random variable  $X$  is represented by a node  $n$  with a finite number of mutually exclusive states  $s_m^n$ . A set of states is defined as  $\mathcal{S}_n : \{s_1^n, \dots, s_M^n\}$ . A probability distribution over these states is defined as a vector  $p(n)$  with  $p(n = s_m^n)$  ( $\forall m \in [1, \dots, M]$ ) is the marginal probability of  $n$  being in states  $s_m^n$ . As illustrated in the graph depicted at Figure 3, nodes  $n_i$  and  $n_j$  are linked by an arc where  $n_i$  is considered as a parent of  $n_j$ .

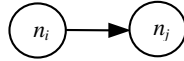

Figure 3: Elementary Bayesian network.

A conditional probability distribution quantifies the probabilistic dependency between  $n_j$  and its parent  $n_i$  and is defined through a Conditional Probability Table (CPT). Therefore, the nodes  $n_i$  and  $n_j$  are defined over the sets  $\mathcal{S}_{n_i} : \{s_1^{n_i}, \dots, s_M^{n_i}\}$  and  $\mathcal{S}_{n_j} : \{s_1^{n_j}, \dots, s_L^{n_j}\}$ . The CPT of  $n_j$  is then calculated by the conditional probabilities  $p(n_j | n_i)$  over each  $n_j$  state according to its parents  $n_i$  states as presented in Table 2.

Table 2: Conditional Probability Table for  $n_j$ .

$n_i$	$n_j$	
	$s_1^{n_j}$	$s_L^{n_j}$
$s_1^{n_i}$	$p(n_j = s_1^{n_j}   n_i = s_1^{n_i})$	$\dots$
$\dots$	$\dots$	$\dots$
$s_M^{n_i}$	$\dots$	$p(n_j = s_L^{n_j}   n_i = s_M^{n_i})$

Concerning the root nodes, *i.e.* those without parent, the CPT contains only a row including the *a priori* probability of each state.

Various inference algorithms can be used to compute marginal probabilities for each unobserved node given information on the states of a set of observed nodes. The most classical one relies on the use of a junction tree. Inference in BN then allows to take into account any state variable observation (an event) such that it updates the probabilities of the other variables. Without observation, the computation is based on *a priori* probabilities. When observations are given, this knowledge is integrated into the network and all the probabilities are updated. Knowledge is formalised as evidence. A *hard evidence* of the random variable  $X$  indicates that the state of the node  $n$  is one of the states  $\mathcal{S}_n : \{s_1^n, \dots, s_M^n\}$ . For instance,  $X$  is in state  $s_1^n : p(n = s_1^n) = 1$  and  $p(n = s_{m \neq 1}^n) = 0$ . Moreover, when this knowledge is uncertain, *soft evidence* can be used to define the distribution over  $n$ .

b) *Bayesian network model as an incidence matrix:*

The relationship between symptoms and faults are represented by a graph. Obviously a fault can be considered as the cause of the residual deviation. Therefore, some connections can be established from the fault to the symptoms in order to define the relation of causality between fault occurrence and the symptom states. Whereupon, a Bayesian network can define directly an incidence matrix  $D(n,j)$ . Let us consider two incidence matrices that represent two different cases of possible isolability conditions (Table 3).

Table 3: Two incidence matrices.

<b>a)</b>					<b>b)</b>				
$D(n,j)$	$F_1$	$F_n$	$F_N$		$D(n,j)$	$F_1$	$F_n$	$F_N$	
$u_1$	1	0	0		$u_1$	0	1	1	
$u_j$	0	1	0		$u_j$	1	0	1	
$u_J$	0	0	1		$u_J$	1	1	0	

As depicted in Figure 4, each above incidence matrix is represented as elementary graph with their appropriate arc which corresponds to the link between fault signature and coherence vectors.

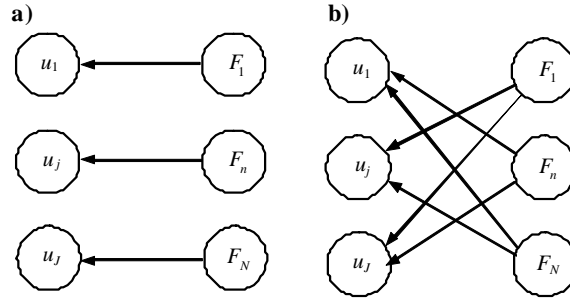

Figure 4: Two structured Bayesian networks.

The fault occurrence probability is modelled as a random variable  $F_n$  associated to each fault.  $F_n$  is described by two states  $\{not\ occurred, occurred\}$ . Moreover, the symptoms are represented also as random variable  $u_j$  defined over the set of two states:  $\{not\ detected, detected\}$  with  $p(u_j=detected)$ , if the fault affects the system and the residual  $r_j$  is detected different from 0.

The probability distribution over the symptom states depends on the false alarms and missing detections. Using Bayesian network model, a CPT is determined to model the relation between variables. In order to compute the probability distribution of symptoms  $u_j$ , a CPT is defined according to the fault  $F_n$  parent of  $u_j$ . For instance, when only one symptom is associated to one fault, as presented at Figure 4a, then the CPT has the structure presented in Table 4:

Table 4: CPT for node  $u_j$  in Figure 3a.

		$u_j$	
		$F_n$	$not\ detected$
$F_n$	$not\ occurred$	$1 - \alpha_n$	$\alpha_n$
	$occurred$	$\beta_n$	$1 - \beta_n$

where the probability  $\beta_n$  of missing detection and the probability  $\alpha_n$  of false alarms both for the fault  $F_n$  are defined such as:

$$\begin{aligned}\alpha_n &= p(u_j = \textit{detected} | F_n = \textit{not occurred}) \\ \beta_n &= p(u_j = \textit{not detected} | F_n = \textit{occurred})\end{aligned}\quad (3)$$

Therefore, the probability distribution over the states of the causes (fault occurrence) is based on the residual evaluation result. The node  $u_j$  is defined as hard evidence. If changes in the residual are detected, then:

$$p(u_j = \textit{detected}) = 1 \quad \text{and} \quad p(u_j = \textit{not detected}) = 0 \quad (4)$$

Otherwise:

$$p(u_j = \textit{detected}) = 0 \quad \text{and} \quad p(u_j = \textit{not detected}) = 1 \quad (5)$$

The Bayes theorem is used to compute  $p(F_n | u_j)$ , for instance, relatively to Figure 4a,  $p(F_n | u_j)$  is equal to:

$$p(F_n | u_j) = \frac{p(F_n)p(u_j | F_n)}{p(u_j)} \quad (6)$$

where  $p(F_n | u_j)$  is the *a posteriori* distribution of probability over the fault states according to the states of the symptoms.  $p(F_n)$  is the *a priori* distribution of probability over the fault states and  $p(u_j | F_n)$  are the conditional distribution over the symptoms.

Generally, several faults are associated to one symptom, as illustrated in Figure 4b. In this case, the CPT is more difficult to determine and it possesses a different structure from Table 4. For instance, when one symptom is associated to few faults, as presented at Figure 4b where few are equal to two, then the CPT is defined as the Table 5.

**Table 5:** CPT for node  $u_j$  in Figure 3b.

		$u_j$		
		$F_1$	$F_N$	<i>not detected</i>
<i>not occurred</i>	<i>not occurred</i>		$1-\alpha_j$	$\alpha_j$
	<i>occurred</i>		$\beta_N$	$1-\beta_N$
<i>occurred</i>	<i>not occurred</i>		$\beta_1$	$1-\beta_1$
	<i>occurred</i>		$\beta_{1,N}$	$1-\beta_{1,N}$

The probability that a false alarm exists, when few faults are the cause of the residual deviation, is estimated independently to the faults. On the contrary, the missing detection depends on the fault, as a fault  $F_1$  has not the same impact on the residual as a fault  $F_N$ . Let us consider that false alarms and missing detections estimated as follows:

$$\begin{aligned}
 p(u_j = \textit{detected} | F_1 = \textit{not o.}, F_N = \textit{not o.}) &= \alpha_j \\
 p(u_j = \textit{not d.} | F_1 = \textit{occurred}, F_N = \textit{not o.}) &= \beta_1 \\
 p(u_j = \textit{not d.} | F_1 = \textit{not o.}, F_N = \textit{occurred}) &= \beta_N \\
 p(u_j = \textit{not d.} | F_1 = \textit{occurred}, F_N = \textit{occurred}) &= \beta_{1,N}
 \end{aligned} \tag{7}$$

where *not d.* (resp. *not o.*) denotes “not detected” (resp. “not occurred”). The definition of false alarms and missing detections are represented Figure 5.

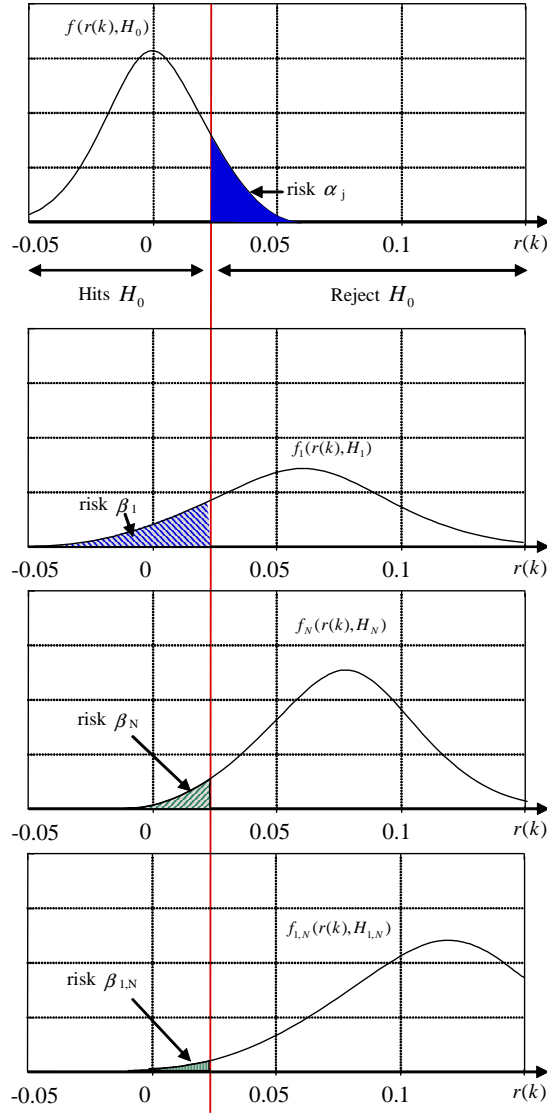

Figure 5: Illustration of the error of the first kind  $\alpha_j$  and error of the second kind  $\beta_1$  and  $\beta_N$ .

As presented in Table 5,  $p(u_j | F_1, F_N)$  is generated according to the incidence matrix defined in Figure 4b.

$p(u_j | F_1, F_N)$  is defined according to the missing detection rate  $\beta_1$  (resp.  $\beta_N$ ) and the false alarm rate  $\alpha_j$  for the fault  $F_1$  (resp.  $F_N$ ).

The Bayes' theorem is applied in the BN inference algorithm to determine  $p(F_N | u_1, u_j)$  from the states of the symptom  $u_1$  and  $u_j$  such as:

$$p(F_N|u_1, u_j) = \frac{p(F_N, u_1, u_j)}{p(u_1, u_j)} = \frac{p(u_1|F_N) \cdot p(u_j|F_N) \cdot p(F_N)}{p(u_1) \cdot p(u_j)} \quad (8)$$

where  $p(F_N|u_1, u_j)$  is the *a posteriori* distribution of probability over the fault states according to the states of the symptoms and  $p(F_N)$  is the *a priori* distribution of probability over the fault states and  $p(u_1|F_N)$ ,  $p(u_j|F_N)$  are the conditional distributions over the symptoms.

### 3.2 Dynamic model of reliability: a dynamic Bayesian network solution [20]

In order to model dynamic behaviour of the system performances degradation, dynamic Bayesian network has been considered. Let us recall some fundamental Markov Chain (MC) model.

In the framework of decision-making, a discrete random variable  $X$  with two states  $\{up, down\}$  is considered. These states represent respectively the operational and failure state of the component. Associated to a discrete random variable  $X$ , a matrix  $P_X$  defines the probabilistic state transitions between (*up*) and (*down*):

$$P_X = \begin{bmatrix} 1 - \varphi_{du} & \varphi_{du} \\ 0 & 1 \end{bmatrix} \quad (9)$$

Where  $\varphi_{du}$  represents the failure probability of the component between sample  $k-1$  and  $k$

$$\varphi_{du} = p(X_k = down | X_{k-1} = up).$$

In reliability analysis,  $\lambda$  represents the failure rate of the component with  $\varphi_{du} \approx \lambda \times \Delta k$  where  $\Delta k$  represents the time interval between  $(k-1)$  and  $(k)$ . It can be noticed that for a constant failure rate, the Mean Time To Failure (MTTF) is equal to  $1/\lambda$ . Based on this elementary definition, a discrete-time Markov chain is defined when the initial state probability vector is specified as  $p(X_0) = [p(X_0 = up) \quad p(X_0 = down)]$ .

The transient analysis of the MC based on the Chapman-Kolmogorov equation [22] provides an expression for

$$p(X_k) \text{ with } p(X_k) = p(X_0) \cdot (P_X)^k \text{ for } k=1,2,\dots$$

Under dynamic consideration in a Bayesian network, the state of the variable  $X_i$  (to model the  $i^{\text{th}}$  component of a system) is represented at sample  $k$  by a node  $n_i(k)$  with a finite number of states.  $p(n_i(k))$  denotes the probability distribution over these states at time step  $k$ . The dynamic Bayesian networks allow to represent random variables and their impacts on the future distribution of other variables [21]. Starting from an observed situation at sample  $k=0$ , the probability distribution  $p(n_i(k))$  over  $M$  states for the component  $X_i$  associated to the node  $n_i$  is computed by the dynamic Bayesian network inference.

Indeed, it is possible to compute the probability distribution of any variable  $X_i$  at sample  $k$  based on the probabilities defined at sample  $k-1$  as shown in the elementary network presented in Figure 6.

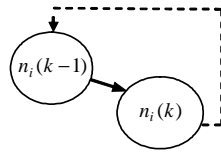

Figure 6: Dynamic Bayesian network for  $X_i$ .

The first slice contains the nodes corresponding to the current time step  $k-1$ , the second one contains the nodes-of the following time step  $k$ . Observations, introduced as hard evidence or probability distributions, are only realised in the current time slice. The time increment is carried out by setting the computed marginal probabilities of the node at sample  $k$  as observations for its corresponding node in the previous time slice. The CPT in dynamic Bayesian network is equivalent to  $P_X$  (Table 6).

Table 6: CPT for node  $n_i(k)$ .

	$n_i(k)$	
$n_i(k-1)$	<i>up</i>	<i>down</i>
<i>up</i>	$1 - \varphi_{du}$	$\varphi_{du}$
<i>down</i>	0	1

3.3. Fusion of the Incidence Matrix and the dynamic Bayesian network model of reliability: a solution for increasing effectiveness of decision-making

As presented previously, the dynamic Bayesian network models the component reliability which takes into account the time degradation of components. The representation of incidence matrix as a graph, defined at the beginning of the paper, provides a formalism, which is used to realize the fusion between fault diagnosis and reliability model. The decision-making is established after fusion of information obtained from both residual analyses and reliability estimation. Therefore, based on the Bayesian network representation, image of the incidence matrix, the dynamic evolution of the component reliability is taken into account on each node  $F_i$  as follows: Figure 7.

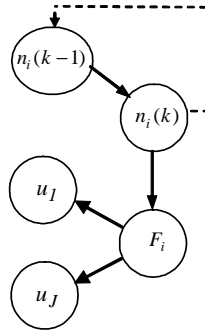

Figure 7: Fault Diagnosis Scheme with DBN for decision-making dedicated to a failure  $F_i$ .

This relationship involves the definition of a CPT. The CPT of  $F_i$  is very simple to define if the component reliability is modelled with the states (*up*) or (*down*) which is a common case in fault diagnosis. Then identity matrix is used to compute the distribution on  $F_i$  as presented in the Table 7.

Table 7: CPT of the node  $F_i$ .

	$F_i$	
$n_i(k)$	<i>not occurred</i>	<i>occurred</i>
<i>up</i>	1	0
<i>down</i>	0	1

However, if more than 2 states are used to define  $n_i(k)$ , the CPT is defined to determine the occurrence of the fault according to the state of degradation of the component. Usually, each functioning states of  $n_i(k)$  leads to the non-faulty state: (*not occurred*), and each faulty states leads to the occurrence of the fault (Table 8)

Table 8: CPT of the node  $F_i$  with a degradation state.

$F_i$		
$n_i(k)$	<i>not occurred</i>	<i>occurred</i>
<i>up</i>	1	0
<i>degradation</i>	1	0
<i>down1</i>	0	1
<i>down2</i>	0	1

It should be possible that fault occurrence is due to the failure of several components. Let's consider two components, the node  $n_j(k)$  and  $n_k(k)$  modelled the state of these components. The fault is occurred when the components are in specific states. Then the combination of the component states is merge in  $F_i$  for instance with AND or OR gate according to the serial or parallel structure (Table 9) (or another combination of the components states).

Table 9: CPT of the node  $F_i$  with OR gate.

$F_i$			
$n_j(k)$	$n_k(k)$	<i>not occurred</i>	<i>occurred</i>
<i>up</i>	<i>up</i>	1	0
<i>up</i>	<i>down</i>	0	1
<i>down</i>	<i>up</i>	0	1
<i>down</i>	<i>down</i>	0	1

Based on the elementary example, illustrated in Figure 6, the computation of  $p(F_i|u_i, u_j, n_i(k))$  is performed thanks to the inference algorithm in dynamic Bayesian network a simplification of the formulation is presented by:

$$p(F_i|u_1, u_j, n_i(k)) = \frac{p(F_i, u_1, u_j, n_i(k))}{p(u_1, u_j, n_i(k))} = \frac{p(F_i|n_i(k))p(u_1|F_i)p(u_j|F_i)}{\sum_{F_i} p(F_i|n_i(k))p(u_1|F_i)p(u_j|F_i)} \quad (10)$$

In this formulation the probability of failure occurrence is deduced from the reliability of the component  $n_i(k)$  and the residuals states  $u_i(k)$  and  $u_j(k)$ . Moreover, the back propagation (from  $F_i(k)$  to  $n_i(k)$ ) allows to verify the coherence when computing the reliability of the component  $n_i(k)$  according to the states of the residuals.

#### 4. ILLUSTRATION EXAMPLE

##### 4.1. Process description and fault diagnosis

To illustrate our approach, a simulation example is considered: a heating water process. The process, presented in Figure 8, is composed of a tank with a section S equipped with two heating resistors  $R_1$  and  $R_2$ . The inputs are the water flow rate  $Q_i$ , the water temperature  $T_i$  and the heater electric power  $P$ . The outputs are the water flow rate  $Q_o$  and the temperature  $T$  which is maintained around an operating point. The temperature of the water  $T_i$  is assumed to be constant. The objective of the thermal process is to provide a constant water flow rate at a given temperature.

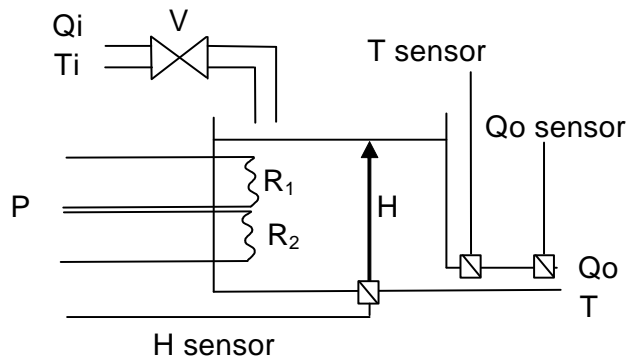

Figure 8: Heating water process.

Using the hydraulic and thermal equations, the system can be described by the following equations:

$$\begin{cases} S \frac{dh(t)}{dt} = q_i(t) - q(t) \\ \frac{dT(t)}{dt} = \frac{P(t)}{\rho C S h(t)} - \frac{(T(t) - T_i) \times q_i(t)}{S h(t)} \end{cases} \quad (13)$$

where  $\rho C$  represents a constant thermal variable and  $T_i$  is equal to 20°C.

Based on previous equation, a discrete state space representation of the system around an operating condition ( $h_{op}=0.6\text{m}$ ,  $T_{op}=50^\circ\text{C}$ ) is determined as follows:

$$\begin{cases} x(k+1) = A_d x(k) + B_d u(k) \\ y(k) = x(k) \end{cases} \quad (16)$$

where the output vector  $y$  is equal to  $[T \quad h]^T$  and the input vector  $u$  defines  $[q_i \quad P]^T$ . It should be noted that the sampling period is fixed to 360s in order to respect the closed-loop time constants.

Moreover, the measured output flow rate can be determined by using the Torricelli-rule as:

$$q_o(k) = \eta \sqrt{h(k)} \quad (19)$$

where  $\eta$  defines the outflow coefficient.

In this study, only sensor failures are considered: level sensor H, output temperature sensor T and output flow rate sensor Qo. As indicated previously, several methods have been proposed in the literature to generate structured residuals and to perform the fault diagnosis [1]. However in this example, due to the property of matrix A (which is diagonal), structured residuals can be generated directly with a conventional observer: each residual is sensitive to one fault. Then based on the state space representation, a conventional Luenberger observer is considered to generate the residuals vector  $y(k) - \hat{y}(k)$ , such that:

$$\begin{cases} \hat{x}(k+1) = A_d \hat{x}(k) + B_d u(k) + K(y(k) - \hat{y}(k)) \\ \hat{y}(k) = \hat{x}(k) \end{cases} \quad (24)$$

Based on the residuals vector  $[r_1(k) \ r_2(k)]^T = [T(k) - \hat{T}(k) \ h(k) - \hat{h}(k)]^T$  evaluation, the symptoms vector  $[u_1(k) \ u_2(k)]^T$  is performed in order to detect fault occurrence on H level sensor or T temperature sensor. Moreover, according to the physical equation between output flow rate  $Q_o$  and liquid level  $H$ , a residual  $r_3(k) = [q_o(k) - \hat{q}_o(k)]$  is calculated.

Based on the residual evaluation of  $r(k) = [r_1(k) \ r_2(k) \ r_3(k)]^T$ , the associated fault incidence matrix is defined in the following table:

Table 10: Incidence matrix.

	$H$	$Q_o$	$T$
$u_1$	0	0	1
$u_2$	1	0	0
$u_3$	1	1	0

#### 4.2. Dynamic BN design for decision-making

The proposed approach has been designed with the help of the software *BayesiaLab* ([www.bayesia.com](http://www.bayesia.com)). The incidence matrix, defined in Table 10, leads to a DBN model presented in Figure 9.

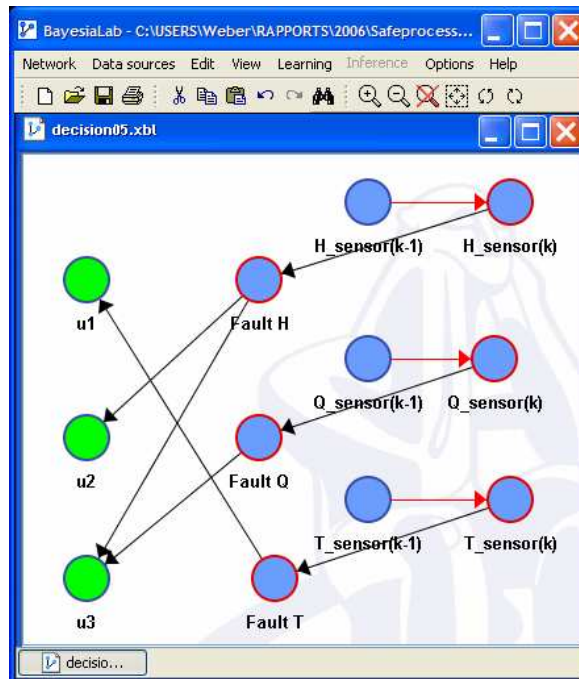

Figure 9: Graphical model of the decision-making with DBN.

For all faults of the system, the probability of missing detection is assumed to be fixed to 0.02 and the probability of false alarms is equal to 0.05. The probability of missing detection with two simultaneous faults is fixed to 0.01. Consequently as presented in §3.1 (see Table 4) the CPT of  $u_1$ , is defined Table 11, and also the CPT of  $u_3$  (see Table 5) is defined Table 12.

Table 11: CPT of the node  $u_1$ .

$u_1$		
Fault T	<i>not detected</i>	<i>detected</i>
<i>not occurred</i>	95	5
<i>occurred</i>	2	98

Table 12: CPT of the node  $u_3$ .

$u_3$			
Fault H	Fault Q	<i>not detected</i>	<i>detected</i>
<i>not occurred</i>	<i>not occurred</i>	95	5
	<i>occurred</i>	2	98
<i>occurred</i>	<i>not occurred</i>	2	98
	<i>occurred</i>	1	99

In order to define the dynamic reliability model, Figure 10 to Figure 12 present the MC and the Mean Time To Failure (MTTF) which is used to determine the failure rates  $\lambda$ . This failure rate quantifies the transition between the states of 3 considering faulty components and associated probabilistic state matrix  $P_x$  defined in eq. (9). The Markov Chains of the components are supposed to be independent. It should be noted that two states  $\{up, down\}$  are considered for sensors Qo and H, but one more state (*dgd*) is considered for sensor T which corresponds to a degraded state of the component. As defined in §3.2., the CPT used to simulate the MC for the sensor H (resp. T) reliability described in Figure 11 (resp. Figure 12) is presented in Table 13 (resp. Table 14). The state (*dgd*) is a functioning state so no fault occurred in this state as implemented in the CPT presented in Table 15.

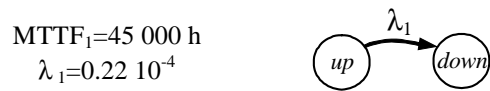

Figure 10: Reliability MC model for sensor Qo.



Figure 11: Reliability MC model for sensor H.

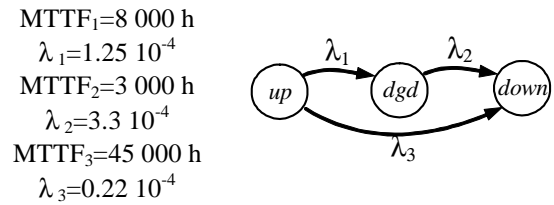

Figure 12: Reliability MC model for sensor T.

Table 13: CPT of the node H\_sensor(k).

H_sensor(k)		
H_sensor(k-1)	<i>up</i>	<i>down</i>
<i>up</i>	99.98	0.02
<i>down</i>	0	100

Table 14: CPT of the node T\_sensor(k).

T_sensor(k)			
T_sensor(k-1)	<i>up</i>	<i>dgd</i>	<i>down</i>
<i>up</i>	99.985	0.012	0.002
<i>dgd</i>	0	99.967	0.033
<i>down</i>	0	0	100

Table 15: CPT of the node Fault\_T.

T_sensor(k)		
T_sensor(k)	<i>up</i>	<i>down</i>
<i>up</i>	100	0
<i>dgd</i>	100	0
<i>down</i>	0	100

### 4.3 Results and comments

Based on the incidence matrix (see Table 10) and under any assumptions of the number of faults, then if the coherence vector issued from the residual evaluation at sample  $k$  is equal to  $[0\ 0\ 1]^T$  or to  $[1\ 1\ 1]^T$ , for example, the fault indicators  $I$  generated by a logic test is as in Table 16.

**Table 16:** Fault indicators.

U	$I_H$	$I_T$	$I_{Q_0}$
$[0\ 0\ 1]^T$	0	0	1
$[1\ 1\ 1]^T$	1	1	1

Because H and T fault signatures are different, and Qo fault signature is included in H fault signature, the fault isolation is not easy to perform:

- when coherence vector is equal to  $[0\ 0\ 1]^T$ , the decision-making provides a fault isolation on sensor Qo ( $I_{Q_0}=1$ ) then a maintenance action is performed to repair this sensor;
- If the coherence vector is equal to  $[1\ 1\ 1]^T$ , the three sensors are suspected to be down with the same possibility ( $(I_H = I_T = I_{Q_0}=1)$ ).

However, based on our approach, it could be possible to optimize the maintenance action.

In order to illustrate the performance and the limitation of the proposed method, various faults scenarios have been considered:

**Scenario A)** A false alarm occurs at sample  $k=6$  which appears as an outlier on sensor T.

**Scenario B)** A bias on the sensor Qo is assumed to occur at sample  $k=9$  and to repair at sample  $k=14$ .

**Scenario C)** The system is in a fault-free case.

**Scenario D)** T and H sensors faults are supposed to occur simultaneously at sample  $k=26$ .

The dynamic behavior of the structured residuals vector has been illustrated in the presence of the various faults scenarios Figure 13.

**Scenario A)** and **Scenario B)** The residual sensitive to a fault is affected. The other residuals are close to zero.

**Scenario C)** The system is in a fault-free case. All residuals are close to zero.

**Scenario D)** According to the fault incidence matrix issued from the structured residuals (see Table 10), all residuals are different from zero at sample  $k=26$  when the sensor faults occur simultaneously.

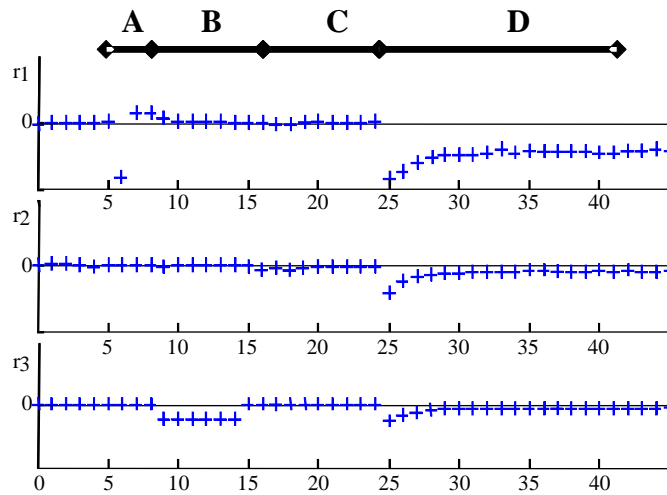

Figure 13: Residuals behavior.

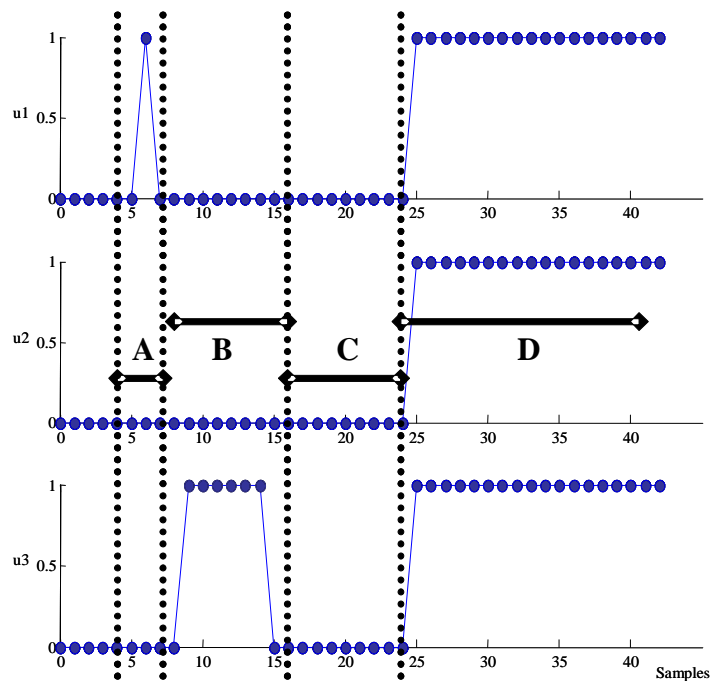

Figure 14: Symptoms scenario.

These residuals are evaluated using the statistical test and are detected isolated correctly as shown in Figure 14:  
**Scenario A)** A false alarm occurs at sample  $k=6$  which appears as an outlier on the first symptom which switch to “1” during one sample.

**Scenario B)** According to the structured residuals defined in the incidence matrix (see Table 10), only the third symptom switched to “1”. Few samples after the third symptom switch to “0” due to a maintenance action.

**Scenario C)** During this period, no fault occurs. Symptoms are equal to “0”.

**Scenario D)** T and H sensors faults are supposed to occur simultaneously. Based on their fault signatures, all symptoms switched simultaneously to “1”.

The failure probabilities for the three sensors are presented at Figure 15 without taking into account the dynamic reliability of components. Figure 16 is devoted to the illustration method through the failure probabilities evolution including the dynamic reliability of components.

**Scenario A)** The outlier generates a false alarm, the CPT for T can only reduce the value of failure probability to 0.9515 computed based on the Baye’s theorem according to the false alarm probability  $\alpha_T=0.05$  and the missing detection  $\beta_T=0.02$  with *a priori* probability distribution:  $p(\text{Fault T= occurred}) = 0.5$  and  $p(\text{Fault T = not occurred}) = 0.5$  (see Figure 15). However, as shown at Figure 16, the decision-making is based on reliability of the component. Thanks to the Bayes’ theorem, the inference algorithm in the BN computes the reliability of the component taking into account the Markov Chain model with failure rate parameters and the on-line information based on the residual evaluation (symptoms). Therefore, if all the symptoms are known and close to 0 then the reliability of the component is close to 1. However, the fault is suspected to have occurred if the residuals deviate from zero. Another advantage, of taking reliability into account, lies in the fact that if the residuals states are not computed or if no ambiguity appears in the fault signature, and then the knowledge relative to the reliability of the component is dominating. In this scenario, the integration of reliability and the symptoms result in similar way a sliding window and therefore annihilate the false alarm.

**Scenario B)** The two BN methods isolate the fault. It could be noted that a time delay is observed for the second one due to reliability consideration. After tree sampling periods, the probability of fault occurrence  $I_Q$  is equal to one. The probability of the  $I_H$  fault occurrence is increased. This fault generates deviation on residual  $u_3$  but according to the inference in the BN, this fault is considered as not coherent with the states of the other symptoms. Therefore, the probability of the  $I_H$  fault occurrence stays close to 0.

**Scenario C)** When a maintenance action is realized, the decision-making is back to a fault free case. The probability that the fault  $I_Q$  occurred is re-initialized to zero.

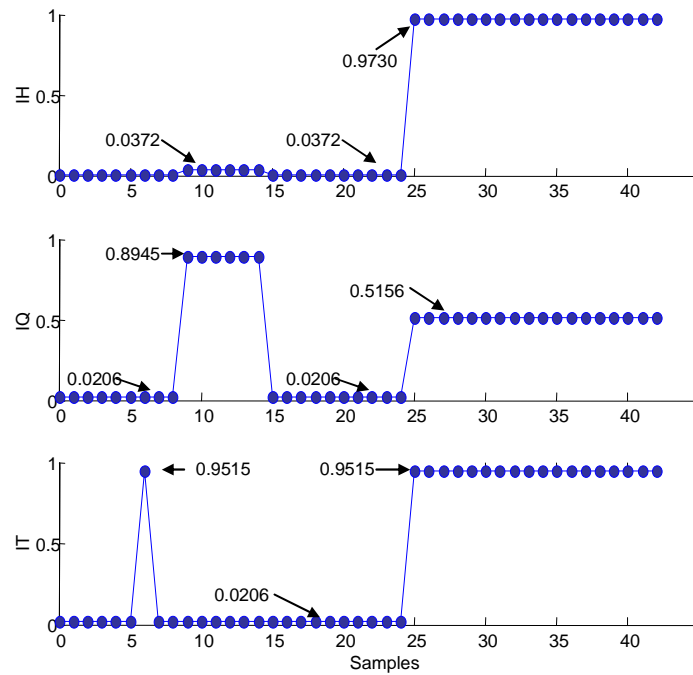

Figure 15: Failure probabilities for the three sensors with BN.

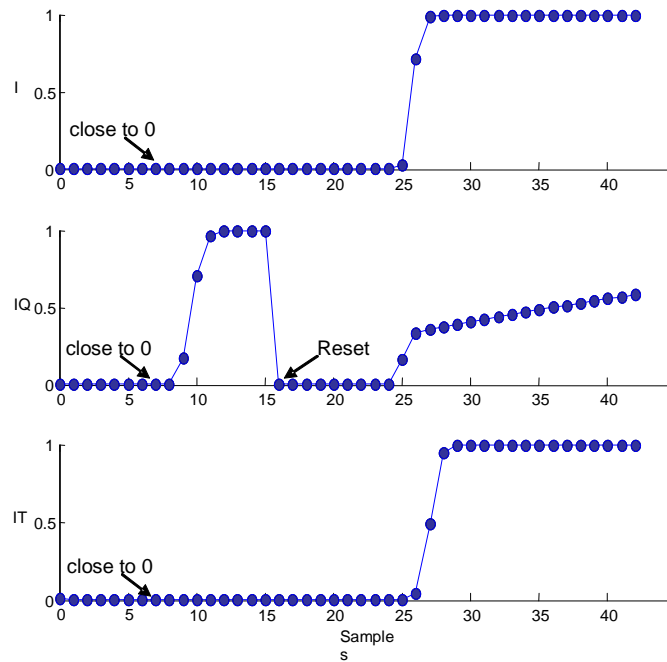

Figure 16: Failure probabilities for the three sensors with DBN and reliability.

**Scenario D)** This scenario highlights the proposed approach. Without reliability consideration, it is not possible to generate a suitable decision-making. For multiple faults, all fault signatures can be suspected: the symptom  $u_3$

is explained by the failure on sensor H, then the  $Q_0$  failure probability is computed based on the Baye's theorem, equal to "0.5156" this value translate the uncertainty (see Figure 15). However, according to the DBN, then the  $Q_0$  failure probability increases by taking into account the reliability of components (Figure 16). *A priori* the fault  $I_Q$  has not occurred. Nevertheless, after long delay, the fault is suspected due to the degradation of the component modeled in the DBN from the failure rate of the component. With the proposed method, it is possible to plan a maintenance action without visiting the Q sensor at the first place due the low level of failure probability. Then, the maintenance action can be focused to the others, T and H sensors, showing a higher level of failure probability.

## 5. CONCLUSION

This paper presents a new strategy to increase the performance of the decision-making in model-based fault diagnosis. The developed approach consists in taking into account in fault diagnosis scheme *a priori* knowledge on the faulty or non faulty system by a Markov chains modelling. Thanks to the Bayes' theorem, the inference algorithm in the BN computes the reliability of the component taking into account the *a priori* Markov Chain model with failure rate parameters and the on-line information based on the residual evaluation (symptoms). Therefore, if all the symptoms are known and close to 0 then the reliability of the component is close to 1. For complex systems, the problem of the decision-making when various fault signatures vectors are identical or similar can be allayed by using a suitable dynamic Bayesian network. The simulation example, a heating water process, has highlighted the performances of the method.

The design of the dynamic Bayesian network requires the false alarms and miss-detection probabilities of the residual evaluation parameters that are not always possible to assess. Nevertheless, the results obtained in this paper are encouraging and allow us to advocate the method in order to optimize the maintenance actions. Therefore, for a system which is liable to various occurring faults simultaneously or which is defined through an incidence matrix with similar fault signatures, the fault probabilities, provided by the method will enable to plan the maintenance actions. In future works we are interesting to analyse the sensitivity of the decision making to the parameter as false alarms and missing detection.

## REFERENCES

- [1] **Isermann R. and Ballé P.** (1996), Trends in the application of model based fault detection and diagnosis of technical processes. *World IFAC Congress*, San Francisco, USA, pp.1-12.
- [2] **Patton R.J., Frank P.M. and Clark R.N.** (2000) *Issues of fault diagnosis for dynamic systems*. Springer Verlag London.
- [3] **Korbick J., Koscielny J.M., Kowalczyk Z. and Cholewa W.** (2004) *Fault Diagnosis, Models, Artificial Intelligence, Applications*. Springer- Verlag.
- [4] **Gertler J.J.** (1998). *Fault detection and diagnosis in engineering systems*. Marcel Dekker, Inc. New York Basel Hong Kong.
- [5] **Chen J. and Patton R.J.** (1999) *Robust model-based fault diagnosis for dynamic systems*. Kluwer academic publishers.
- [6] **Sauter D, Dubois G., Levrat E. and Bremont J.** (1993) Fault diagnosis in systems using fuzzy logic, *EUFIT'93*, Aachen, Germany, vol. 2, pp. 781-788.
- [7] **Cassar J.P., Litwak R.G., Cocquempot V. and Staroswiecki M.** (1994) Approche structurelle de la conception de systèmes de surveillance pour des procédés industriels complexes, *Diagnostic et sûreté de fonctionnement*, **Vol. 4**, No. 2, pp. 179-202.
- [8] **Theilliol D., Weber P., Ghetie M. and Noura H.** (1995). A hierarchical fault diagnosis method using a decision support system applied to a chemical plant. *IEEE International on Systems, Man and Cybernetics*, Vancouver, Canada, vol. 3, pp. 2205-2210.
- [9] **Evsukoff A. and Gentil S.** (2005). Recurrent neuro-fuzzy system for fault detection and isolation in nuclear reactors. *Advanced Engineering Informatics*, Vol. 19, No. 1, pp. 55-66.
- [10] **Isermann R.** (1994) Integration of fault detection and diagnosis methods, *IFAC Symposium on Fault Detection Supervision and Safety for Technical Processes*, Espoo, Finland, pp. 597-612.
- [11] **Anrig B. and T. Kohlas J.** (2002). Model-based reliability and diagnostic: a common framework for reliability and diagnostics. *13th IFAC Workshop on Principles of Diagnosis, DX*, Semmering, Austria.
- [12] **Frank P.M.** (1990) Fault diagnosis in dynamic systems using analytical and knowledge-based redundancy - A survey and some results, *Automatica*, **26**, pp. 459-474.
- [13] **Patton R.J., Frank P.M. and Clark R.N.** (1989) *Fault diagnosis in dynamic systems – Theory and application*. Prentice Hall.

- [14] **Montmain J. and Gentil S.** (2000), Dynamic causal model diagnostic reasoning for on-line technical process supervision, *Automatica*, **36**, pp. 1137-1152.
- [15] **Basseville M. and Nikiforov I.** (1997) *Detection of abrupt changes: theory and application*. Prentice Hall Information and System Sciences series. ISBN 0-13-126780-9.
- [16] **Young T. Y. And Calvert T. W.** (1974) *Classification, Estimation and Pattern recognition*. American Elsevier Publishing. ISBN 0-444-00135-2.
- [17] **Weber P., Gentil S., Ripoll P. and Foulloy L.** (1999) Multiple fault detection and isolation. *World IFAC Congress*, Beijing, R.P. China, vol. P, pp. 223-228.
- [18] **Bonivento C., Marconi L., Paoli A. and Rossi C.** (2003) A framework for reliability analysis of complex diagnostic systems. *IFAC Symposium on Fault Detection Supervision and Safety for Technical Processes*, Washington DC, USA, pp. 567-572.
- [19] **Jensen, F.V.** (1996). *An Introduction to Bayesian Networks*. (UCL Press (Ed)). London.
- [20] **Weber P. and Jouffe L.** (2003). Reliability modelling with Dynamic Bayesian Networks. *IFAC Symposium on Fault Detection Supervision and Safety for Technical Processes*, Washington DC, USA, pp 57-62.
- [21] **Murphy K.** (2002). *Dynamic Bayesian Networks: Representation, Inference and Learning*. PhD thesis, Dept. Computer Science, UC Berkeley.
- [22] **Cassandras C.G. and Lafortune S.** (1999). *Introduction to Discrete Event Systems*. Kluwer Academic Publishers.