



HAL
open science

FOLLOW-ME: a new 3D interaction technique based on virtual guides and granularity of interaction

Nassima Ouramdane, Samir Otmane, Frédéric Davesne, Malik Mallem

► **To cite this version:**

Nassima Ouramdane, Samir Otmane, Frédéric Davesne, Malik Mallem. FOLLOW-ME: a new 3D interaction technique based on virtual guides and granularity of interaction. 2nd ACM International Conference on Virtual Reality Continuum and Its Applications (VRCIA 2006), Jun 2006, Hong Kong, China. pp.137–144, 10.1145/1128923.1128945 . hal-00339475

HAL Id: hal-00339475

<https://hal.science/hal-00339475>

Submitted on 29 Nov 2008

HAL is a multi-disciplinary open access archive for the deposit and dissemination of scientific research documents, whether they are published or not. The documents may come from teaching and research institutions in France or abroad, or from public or private research centers.

L'archive ouverte pluridisciplinaire **HAL**, est destinée au dépôt et à la diffusion de documents scientifiques de niveau recherche, publiés ou non, émanant des établissements d'enseignement et de recherche français ou étrangers, des laboratoires publics ou privés.

FOLLOW-ME : a new 3D interaction technique based on virtual guides and granularity of interaction

Nassima OURAMDANE *

IBISC Laboratory
University of Evry / CNRS FRE 2873
40, rue du Pelvoux, 91000 Evry, France

Samir OTMANE ‡

IBISC Laboratory
University of Evry / CNRS FRE 2873
40, rue du Pelvoux, 91000 Evry, France

Frédéric DAVESNE †

IBISC Laboratory
University of Evry / CNRS FRE 2873
40, rue du Pelvoux, 91000 Evry, France

Malik MALLEM §

IBISC Laboratory
University of Evry / CNRS FRE 2873
40, rue du Pelvoux, 91000 Evry, France

Abstract

The implementation of an interaction between a user and a Virtual Environment (VE) in Virtual Reality (VR) may use various techniques. However, in some cases, the interaction must be very precise and comfortable for the user. In this paper, we introduce a new selection and manipulation technique called FOLLOW-ME. The model associated to this technique splits the Virtual Environment into three zones in which a specific interaction model is used: a free manipulation zone, a scaled manipulation zone and a precise manipulation zone. Each one of the three zones is characterized by a specific interaction granularity which defines the properties of the interaction in the concerned zone. This splitting is created in order to have both precision near the object to reach or to manipulate (scaled and precise manipulation zones) and to maintain a realistic and free interaction in the VE (free manipulation zone). In the precise manipulation zone, we use the concept of virtual guides in order to assist user. In this paper, we exhibit the formalization of the model associated to the FOLLOW-ME technique. Then, we both compare our technique with classical interaction techniques in the case of a task which consists in trying to reach an object in VE and give some insights about the conditions of usefulness of virtual guides in a selection task. Some preliminary experimental results are presented and discussed.

CR Categories: I.3.6 [Methodology and Techniques]: Interaction techniques; H.5.2 [User Interfaces]: Theory and methods

Keywords: 3D interaction technique, virtual guide, granularity of interaction.

1 INTRODUCTION

As the technology of display and graphics systems has developed, VEs applications have come into common use outside the research laboratory [Gobel 1996]. The technology of VEs offers to the user

new interfaces which enable him to interact easily and naturally with the VE. Currently, interaction is one of the main issues related to the majority of applications in this field.

There are a lot of existing human-computer interaction techniques, which attempt to solve the problem of grabbing and manipulating objects in VEs [Bowman et al. 2005; Frees and Kessler 2005; Liang 1994; Mine et al. 1997; Pierce et al. 1997; Poupyrev et al. 1996; Stoakley et al. 1995]. In general, the VE is considered to be uniform so that the interaction technique applies identically at each point of VE. We think that it may be useful to apply different interaction techniques in different zones of VE whether the virtual tool used to select or manipulate an object is far or near to the object. As an example in today's life, if one wants to grab an object, his arm is firstly moving fast to the target and, when approaching, it slows down and then the hand uses a grabbing strategy to take the object. The different steps of the task may be characterized by different needs of precision (lower precision far from the target and higher precision near to the target). This induces the idea of *granularity of interaction* that is used in our model.

What precisely interests us in the splitting of VE is the possibility to have both a wide zone in which the user interacts freely and realistically with the virtual world and also limited zones near the objects to select or manipulate where there exists a strong assistance to the user that offers him precision and easiness to accomplish his task. The assistance may be materialized by visual cues (like Ray Casting [Mine et al. 1997]) in the VE or an active assistance to reach and grab an object. For example, in this article, we use virtual guides [Otmene et al. 2000a] [Rosenberg 1993] for this active assistance.

In general, the study of the interaction involves the specification of both:

- A technique and a formal model that specifies the relation between a user (or a group of users) and a virtual world;
- The devices needed to implement the model;
- A suitable evaluation method which validates or invalidates the proposed model.

In this paper, we propose a formal model that includes the notion of granularity of interaction and the notion of virtual guides. To evaluate the performances of our technique, we use a formal measurement method inspired from the testbed evaluation method [Bowman et al. 2001]. We keep some criteria utilized in [Bowman et al. 2001] like the comparison of task completion time (speed). Besides, we want to find a compromise between the necessity of having free and realistic interaction (which may be barely precise) and the necessity to manipulate an object with high precision (which uses virtual guides that induce quite unrealistic interactions). This compromise may be found in our model by finding an appropriate splitting of VE. In this paper, we show that the evolution of the

*e-mail: nassima.ouramdane@ibisc.fr

†e-mail: frederic.davesne@ibisc.fr

‡e-mail: samir.otmane@ibisc.fr

§e-mail: malik.mallem@ibisc.fr

Copyright © 2006 by the Association for Computing Machinery, Inc.

Permission to make digital or hard copies of part or all of this work for personal or classroom use is granted without fee provided that copies are not made or distributed for commercial advantage and that copies bear this notice and the full citation on the first page. Copyrights for components of this work owned by others than ACM must be honored. Abstracting with credit is permitted. To copy otherwise, to republish, to post on servers, or to redistribute to lists, requires prior specific permission and/or a fee. Request permissions from Permissions Dept, ACM Inc., fax +1 (212) 869-0481 or e-mail permissions@acm.org.

VRCIA 2006, Hong Kong, 14–17 June 2006.

© 2006 ACM 1-59593-324-7/06/0006 \$5.00

distance to the target over time may be used as a new criterium to achieve a correct splitting of VE.

In section 2, we present a short review of related interaction techniques which are commonly utilized in the context of VR. Section 3 describes the FOLLOW-ME technique. Section 4 gives experimental results in a simple VR world in which the FOLLOW-ME technique and other classical techniques are compared.

2 RELATED WORK

Obtaining realistic interactions between a user and a virtual world is the main issue of the majority of applications in Virtual Reality. A lot of work about VR systems exists nowadays, but the formalization of the interaction itself has not really been studied intensively yet.

Figure 1 shows a simple classification of the current VE interaction techniques depicted in [Poupyrev et al.]. Interactions may be

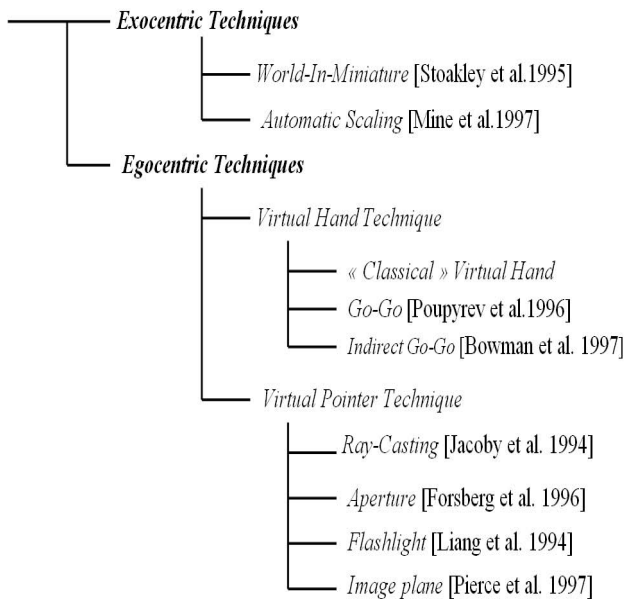

Figure 1: Classification of VE Interaction techniques (adapted from [Song et al. 2000])

parted into two categories: *exocentric interactions* and *egocentric interactions*.

In the case of exocentric interactions (also known as the God’s eye viewpoint), users interact with Virtual Environments (VEs) from the outside (the outside-in world referenced display). As an example, we may refer to the *World-In-Miniature* technique. Here, users hold a small representation of the environment in their hand, and manipulate virtual objects by manipulating the iconic versions of those objects in the miniature world [Stoakley et al. 1995].

In the case of egocentric interactions, which is the most common case for immersive VEs, the user is interacting from inside the environment. Currently there are two basic metaphors for egocentric interactions: *virtual pointer* and *virtual hand*.

In the first case, the user selects and manipulates objects by pointing at them. When the vector emanating from the virtual pointer intersects with an object, it may be picked and manipulated [Pierce

et al. 1997]. The main design aspects that distinguish the techniques using the virtual pointer concern the definition of the virtual pointer direction, shape (selection volume) and methods for disambiguating the object the user wants to select. In the simplest case, the direction of the virtual pointer is defined by the orientation of the virtual hand. In other cases, the direction of the virtual pointer is specified by using two points: position of the user’s dominant eye and location of the tracker manipulated by the user [Pierce et al. 1997]. As an example, we may refer to the *Ray-Casting* technique [Mine et al. 1997]. This technique uses the metaphor of a laser pointer - an infinite ray extending from the virtual hand. The first object intersected along the ray is eligible for selection. This technique is very efficient to achieve selection tasks. The flash light technique [Liang 1994] is based on the same principle as the Ray-casting technique, but it replaces the laser pointer by an infinite cone. It allows the selection of remote or small objects, but it presents ambiguities in the selection of close objects.

In the second case, users can grab and position objects by touching and picking them with a virtual representation of their real hand. As an example, we may refer to the *Simple Virtual Hand technique* [Bowman et al. 2005], the *Go-Go technique* [Poupyrev et al. 1996] and the *PRISM technique* [Frees and Kessler 2005]. The Simple Virtual Hand is used for selection or manipulation tasks. It uses a one-to-one mapping between the virtual hand and the physical hand. Selection is made via direct “touching” of virtual objects. In general, this is done by intersecting the virtual hand with a virtual object. The Go-Go technique also called arm-extension technique is based on the Simple Virtual Hand, but it introduces a non one-to-one linear mapping between the virtual hand and the physical hand. The selection of remote or small objects is very difficult with the simple virtual hand and the Go-Go techniques. The PRISM technique is used as an addition to other existing techniques to increase precision.

3 DESCRIPTION OF THE FOLLOW-ME TECHNIQUE

3.1 Main properties

When one grabs an object with his hand, his arm has a fast and roughly precise movement far from the target, a precise and slower movement when approaching the target and a grabbing strategy associated to the geometry of the object. Each of the three steps may be associated to a particular interaction strategy and may have what we will call a specific *interaction granularity* (see par. 3.2 for more details).

The FOLLOW-ME technique takes inspiration from this simple grabbing example. It owns two main characteristics:

- the VE is divided into three zones in which the interaction has its own granularity, whether one wants to navigate freely and realistically in the VE (free manipulation zone), approach more securely to a target but without loosing any degree of freedom (scaled manipulation zone) and finally approach to the target and manipulate it easily with high security (precise manipulation zone);
- In the precise manipulation zone, virtual guides are used to handle both precision and security of manipulation, which induces a loss of freedom for the user. The aim of a virtual guide is firstly to anticipate the most probable action of the user into the VE and then to make him perform his action as simply as possible with high precision. In order to achieve this goal, the virtual guide puts limitations to the user’s possible actions

in the virtual world so that he has to *follow* the virtual guide with a specific subspace of VE (with a specific orientation). The specifications of virtual guides is given in par. 3.3. This characteristic of the interaction has led us to call our technique the *FOLLOW-ME technique*.

3.2 Definition of granularity of interaction

The *granularity of interaction* determines the way the user interacts with the VE. In practice, it specifies the consequences of the movements of the user (in the real world) on the virtual world. The consequences may be expressed as a difference of movements amplitude between the two worlds or a loss of degree of freedom of the movement in the virtual world compared to the real world.

If one wants more precision for the interaction, a movement in the real world should be translated into a smaller movement in the virtual world. Oppositely, one may want to produce big movements in the virtual world corresponding to small movements in the real world (as in the Go-Go technique [Poupyrev et al. 1996]).

In another way, if the computer system is able to anticipate what the user may want to manipulate in the VE and if it has a precise model of the object to manipulate, virtual guides may be used. In practice, this leads to a loss of degree of freedom in the VE. For example, in a grabbing task, the system has a model of how to grab the object and the user only decides to go forward to the object and grab it or to go backward and do something else.

3.3 Virtual guides

For a review of virtual guides, one may refer to [Otmame et al. 2000a; Otmame et al. 2000b; Rosenberg 1993].

Each virtual guide is characterized by properties allowing the user and the system to identify it [Fig. 2]. A virtual guide is characterized by:

- *An attachment* : Each virtual guide can be attached (statically or dynamically) to a virtual object or a place of the virtual environment. Thus, we define for each guide a position and an orientation in the space defined by the virtual environment.
- *A manipulation area* : for each virtual guide a manipulation area is associated. In general, this area is defined by an analytical equation which delimits the shape of the guide.
- *A condition of activation* : for each guide a condition of activation is associated this condition depends on the zone of influence or an external event.
- *A function* : The function of the guide defines the actions which it must achieve.
- *A condition of inhibition* : The condition of inhibition stops the function of the virtual guide.

Virtual guides can be simple (Fig. 2(a)) or complex with easy deformation capabilities(Fig. 2(b),(c)). For simplicity without loss of generality, to illustrate virtual guides, an implementation related to a pick and place task is presented. Fig. 2(a) and Fig. 2(d) show the use of a simple virtual guide (cone primitive) to help the user in reaching the target (3D point). Fig. 2(b) and Fig. 2(e) show a complex virtual guide used to unhook the actual object. It is a combination of 3 simple guides (all cylinder shaped). Each simple guide (cylinders 1, 2, 3) is activated when the virtual stem is in the selection area. The role of this complex guide is to assist the user in selecting the target with the virtual stem in order to peg and to unhook it from its stand. Another example of complex virtual guide

is given in Fig. 2(c) and Fig. 2(f). It is composed of 4 simple guides (one cone and three cylinders). In fact this complex guide helps the user to put the object cylinder onto the stand.

3.4 The FOLLOW-ME model

3.4.1 The FOLLOW-ME model principles

The VE is divided into three zones (free manipulation zone, scaled manipulation zone and precise manipulation zone). Each object of VE which may be selected or manipulated has its own scaled manipulation zone and precise manipulation zone which are volumes surrounding the object (see Fig. 3 (a)). The user interacts with VE by using a virtual tools (virtual pointer or virtual hand). We associate a set of states to the virtual tool whether it is in the free manipulation zone (*Free_Manip_Stat*), the scaled manipulation zone (*Scaled_Manip_Stat*) or the precise manipulation zone (*Precise_Manip_Stat*) of an object (see Fig. 3 (b)). Each state is linked with a specific granularity of interaction (depending on where the virtual tool is in VE):

- the *Free_Manip_Stat* is linked with a high granularity interaction. This means that a movement in the real world is translated as is for the virtual tool in VE (the gain k_S is equal or upper than 1). Any classical interaction technique may be used. In the experiment described in section 4, we have chosen the Go-Go technique;
- the *Scaled_Manip_Stat* is linked with a medium granularity interaction. This means that a huge movement in the real world is translated into a smaller movement of the virtual tool in VE. In our experiments, we have considered a linear relation between the real position of the user and the position of the virtual tool with a gain $0 < k_S < 1$;
- the *Precise_Manip_Stat* is linked with a low granularity interaction. We use virtual guides in order to assist user. In this case, the degree of freedom for the virtual tool in VE is reduced to 1 so that the movements of the user are interpreted as a *go forward to the target* decision or a *go backward* decision. This means that the virtual tool may move along a 1D curve in VE.

A transition between one state to another corresponds to a modification of the granularity of interaction. We will see in par. 3.4.3 that it corresponds to a modification of the equation that handles the evolution of the virtual position and orientation of the virtual tool. In practice, when the virtual tool enters the scaled manipulation zone associated to a target, the virtual guide appears (visual assistance). The virtual guides utilized in our experiments are cubes. It allows the virtual tool to reach the target with different orientations (not only perpendicularly to the target). The precise manipulation zone corresponds to the volume of the cube.

3.4.2 Notations

The user's hand has a 3D position \vec{P}_r and a 3D orientation $\vec{\theta}_r$ at each time t . The resulting virtual position and orientation in VE are respectively \vec{P}_v and $\vec{\theta}_v$. The linear velocity of the user's hand is noted \vec{V}_r and its angular velocity is noted $\vec{\omega}_r$. The linear velocity of the virtual tool is noted \vec{V}_v and its angular velocity is noted $\vec{\omega}_v$.

We depict \vec{C}_* and $\vec{\theta}_*$ as the position of the target and the orientation of its normal. The time at which a transition between two states

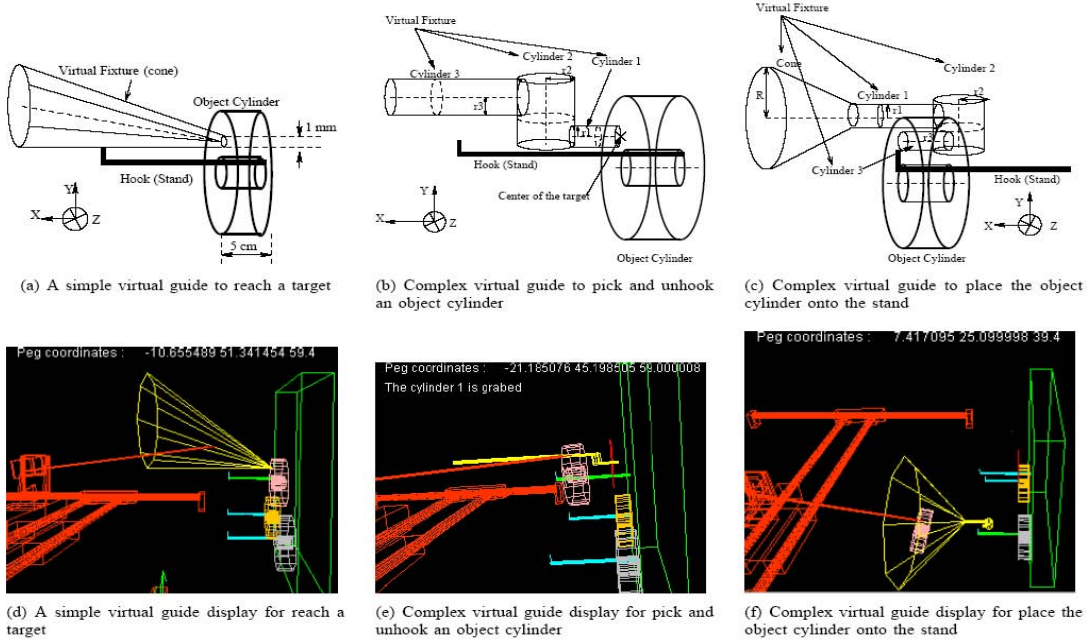

Figure 2: Some examples of Virtual Guides used in the ARITI application (adapted from [Otmame et al.2000a])

happen is noted t_0 .

3.4.3 Formalization of the FOLLOW-ME model

For each state of the virtual tool, there exists a unique set of equations that gives its position $\vec{P}_v(t)$ and orientation $\vec{\theta}_v(t)$ in VE at time t . In the following, we will have a look at these equations. They may have *a priori* free parameters. However, when the virtual tool quits a zone of VE at time t_0 to enter another one which has a different granularity of interaction, a state transition happens in the graph and the set of equations that computes $\vec{P}_v(t)$ and $\vec{\theta}_v(t)$ changes. It is necessary that there exists a continuity constraint at time t_0 over $\vec{P}_v(t)$ and $\vec{\theta}_v(t)$. Hence, this continuity constraint permits to fix some *a priori* free parameters because it is possible to know the values of $\vec{P}_v(t_0)$, $\vec{P}_r(t_0)$, $\vec{\theta}_v(t_0)$ and $\vec{\theta}_r(t_0)$ at time t_0 . In the following, when we will type $\vec{P}_r(t_0)$ or $\vec{\theta}_r(t_0)$, it will mean: $\vec{P}_r(t_0)$ or $\vec{\theta}_r(t_0)$ computed with the former set of equations valid just before t_0 (former granularity of interaction).

Let us describe the equations mapping between $(\vec{P}_r(t), \vec{\theta}_r(t))$ and $(\vec{P}_v(t), \vec{\theta}_v(t))$ for the three states of the virtual tool.

Free_Manip_Stat state : For the *Free_Manip_Stat* state, we have chosen the equations associated to the Go-Go technique (see [Poupyrev et al. 1996]).

Scaled_Manip_Stat state : For the *Scaled_Manip_Stat* state, we consider a gain k_S between the real and virtual velocities. k_S is a positive real value. As we want to be more precise in the scaled manipulation zone, k_S must be less than 1. We have the following set of equations:

$$\vec{P}_v(t) = k_S \cdot \vec{P}_r(t)$$

$$\vec{\theta}_v(t) = \vec{\theta}_r(t)$$

The integration of the two former equations over time gives:

$$\begin{aligned} \vec{P}_v(t) &= k_S \cdot \vec{P}_r(t) + \vec{b}_1 \\ \vec{\theta}_v(t) &= \vec{\theta}_r(t) + \vec{b}_2 \end{aligned}$$

Where \vec{b}_1 and \vec{b}_2 are 3D free parameters. As $\vec{P}_v(t)$ and $\vec{\theta}_v(t)$ must be continuous at time t_0 , we deduce the value of \vec{b}_1 and \vec{b}_2 :

$$\begin{aligned} \vec{b}_1 &= \vec{P}_v(t_0) - k_S \cdot \vec{P}_r(t_0) \\ \vec{b}_2 &= \vec{\theta}_v(t_0) - \vec{\theta}_r(t_0) \end{aligned}$$

Replacing \vec{b}_1 and \vec{b}_2 by their expression in the former equations, we have finally:

$$\begin{aligned} \vec{P}_v(t) &= k_S \vec{P}_r(t) + \vec{P}_v(t_0) - k_S \vec{P}_r(t_0) \\ \vec{\theta}_v(t) &= \vec{\theta}_r(t) + \vec{\theta}_v(t_0) - \vec{\theta}_r(t_0) \end{aligned}$$

Precise_Manip_Stat state : If the virtual tool is in the *Precise_Manip_Stat*, it is guided to reach with high precision the center \vec{C}_* of the target T_* . \vec{C}_* is supposed to be perfectly known.

We first split the expression of $\vec{P}_v(t)$ in two sub-expressions:

$$\vec{P}_v(t) = f(\vec{P}_r(t), \vec{P}_r(t)) \cdot g(\vec{P}_v(t), \vec{C}_*) \quad (1)$$

The function f is specialized in the impact of the movement of the user on the velocity of the virtual tool, whereas the function g is dedicated in the evolution of the velocity of the virtual tool independently from the user movements.

First, let's consider how we have built the function g . The idea we have is to diminish the linear velocity of the virtual tool when approaching to the target so that the virtual tool position converges to \vec{C}_* . It may be written as follows:

$$\vec{P}_v(t) = k_M \cdot (\vec{C}_* - \vec{P}_v(t)) \quad (2)$$

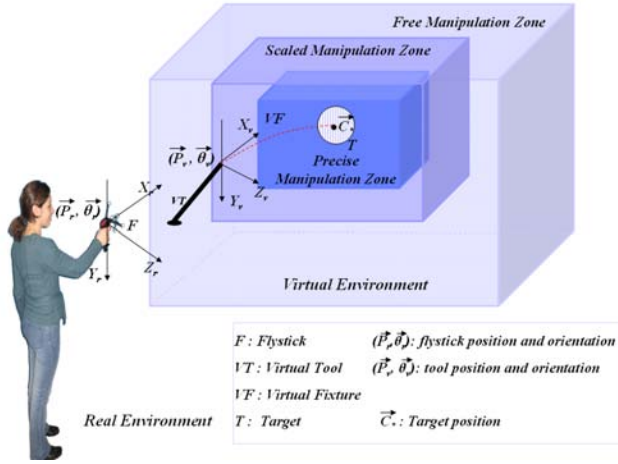

(a) the interaction of user with the VE including three different zones

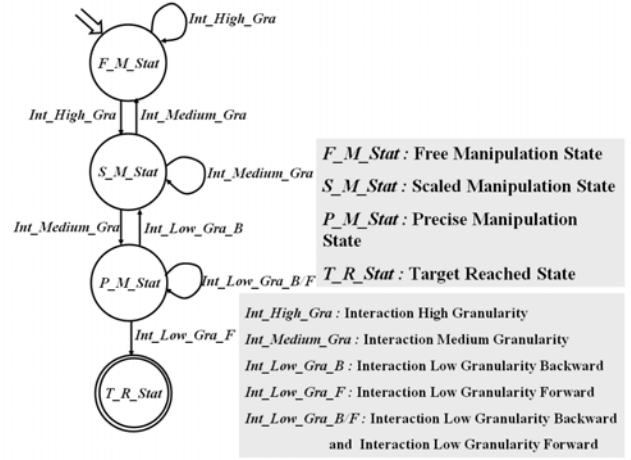

(b) State graph associated with the evolution of the virtual tool in the three zones of VE

Figure 3: The Follow-Me Model

Where k_M is a real parameter. In practice, k_M will depend on the value of $f(\vec{P}_r(t), \vec{P}_r(t))$. In the following, we will first consider that k_M is constant over time. The equation 2 is a first order linear differential equation over $\vec{P}_v(t)$. The general solution of this equation is:

$$\vec{P}_v(t) = \vec{a}.e^{-k_M.t} + \vec{b} \quad (3)$$

Where \vec{a} and \vec{b} are 3D free parameters. Taking the derivative of this equation, we have:

$$\vec{P}'_v(t) = -k_M.\vec{a}.e^{-k_M.t}$$

Taking the right part of the former equation and the right part of equation 2 at time t_0 , we get:

$$\vec{a} = (\vec{P}_v(t_0) - \vec{C}_*) . e^{k_M.t_0}$$

Including the value of \vec{a} in the equation 3 at time t_0 , we have:

$$\vec{b} = \vec{C}_*$$

So, including the value of \vec{a} and \vec{b} in equation 3, we finally get:

$$\vec{P}_v(t) = (\vec{P}_v(t_0) - \vec{C}_*) . e^{(-k_M.(t-t_0))} + \vec{C}_* \quad (4)$$

Now let's establish the specification of the function f (see equation 1) which is linked with the value of k_M .

First, let's stress that if $k_M > 0$, $\vec{P}_v(t)$ converges to \vec{C}_* as t grows, whereas if $k_M < 0$, $\vec{P}_v(t)$ diverges from \vec{C}_* as t grows. Besides, if $k_M = 0$, the virtual tool keeps still ($\vec{P}_v(t) = \vec{P}_v(t_0)$). The idea is to convert the user movements into three possible values of k_M :

- $k_M^+ > 0$, associated with the action of going forward to the target (transition $Int_Low_Gra_F$ in the graph);
- $k_M^- < 0$, associated with the action of going backward to the scaled manipulation zone (transition $Int_Low_Gra_B$ in the graph);
- $k_M^0 = 0$, associated with a virtual tool that do not move.

We consider that the orientation of the virtual tool evolves as its position over time. The orientation will be given by the following equation:

$$\vec{\theta}_v(t) = (\vec{\theta}_v(t_0) - \vec{\theta}_*) . e^{(-k_\theta.(t-t_0))} + \vec{\theta}_* \quad (5)$$

Where k_θ is a positive real.

A simulated example of the evolution of a 1D virtual tool to a target is given by figure 4.

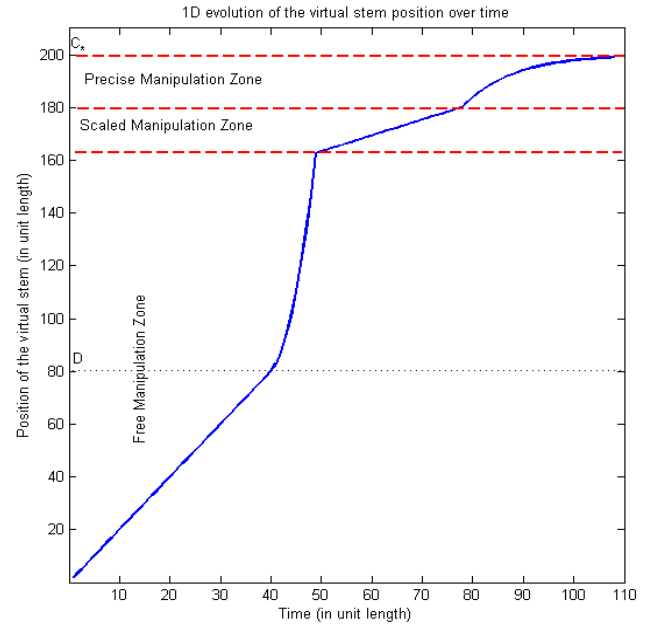

Figure 4: Example of 1D evolution of the virtual tool position over time

4 EXPERIMENTS

4.1 Aim of the experiments

In the following experiments, we compare the FOLLOW-ME the Go-Go techniques. However, one must be very careful with what may be really compared. Indeed, as a virtual guide permits to reach the associated target with the highest possible precision when selected, it is not fair to compare the precision of the different techniques. The two techniques are implemented in the same Virtual Environment which is composed of one static target put on a wall.

4.2 Experimental setting

Figure 5 shows the experimental setting. The user is situated in front of a workbench (3,20x2,40 m). He interacts with the virtual world by using a Flystick which determines the position $\vec{P}_r = [X_r, Y_r, Z_r]$ and orientation $\vec{\theta}_r = [\theta_r^X, \theta_r^Y, \theta_r^Z]$ of his hand in real time. This is done by using an ART tracking system using two infrared cameras placed on the left and the right opposite sides of the workbench.

The position and orientation of the Flystick determine the position $P_v = [X_v, Y_v, Z_v]$ and orientation $\theta_v = [\theta_v^X, \theta_v^Y, \theta_v^Z]$ of the virtual tool used in the virtual world to reach the targets. The model associated with the FOLLOW-ME technique gives the formal relation between the couple (P_r, θ_r) and the couple (P_v, θ_v) .

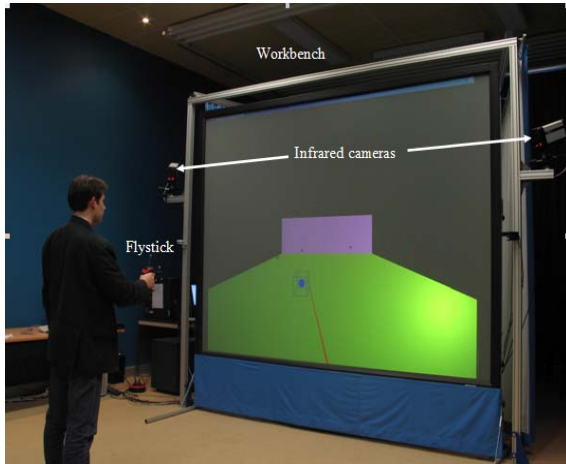

Figure 5: Experimental setting

4.3 Experimental protocol

A target T (disk centered on $C_T = [X_T, Y_T, Z_P]$ with diameter D_T) is situated on a wall which is parallel to the Ox/Oy axis, at depth $Z = Z_p$. The user may control a virtual tool which position is $[X_S, Y_S, Z_S]$ and orientation $[\theta_S^X, \theta_S^Y, \theta_S^Z]$.

The virtual tool is represented by virtual hand. In the experiment, we compare two techniques (Go-Go and FOLLOW-ME). The Go-Go technique is implemented with two types of assistance:

- without assistance (classical Go-Go technique);
- visual assistance in the form of virtual ray (see figure 6(a)).

The virtual ray is used to help the user in the selection task. Figure 6 shows VE for the Go-Go and FOLLOW-ME techniques.

The user is told to reach the target with the virtual tool as fast as

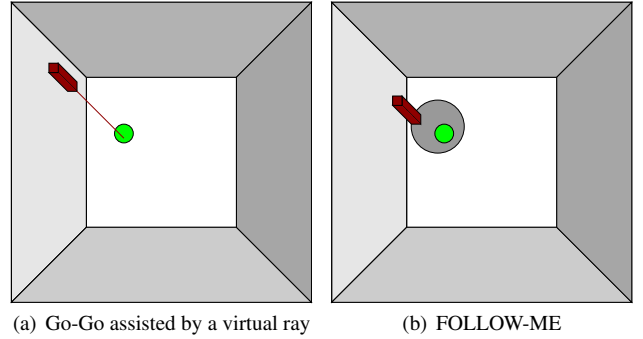

Figure 6: Two examples of the VE used in our experiments

possible. The target is reached as soon as the virtual tool intersects the disk T . Two performance cues are considered:

- (K_1) laps of time to teach the target;
- (K_2) evolution of the distance between the the virtual tool (virtual hand) and the target during time

Whereas the first cue is classically used, we think that the second one is particularly relevant. Indeed, when far from the target, the user will probably make the virtual tool nearer to the target very easily without any assistance (visual or other). But, when approaching to the target, errors in piloting the virtual tool may occur if the target is small enough. The consequence of an error is the growth of K_2 during the trial. The zone around the target in which K_2 may grow corresponds precisely to zone in which the user needs assistance to reach the target. So, the K_2 cue may be used to determine the minimum volume of the zone surrounding the target in which assistance has to be utilized. This may determine the appropriate volume of the scaled and precise manipulation zones for the FOLLOW-ME technique.

4.4 Experimental results

In this paper, we present preliminary results for comparing the FOLLOW-ME technique to classical interaction techniques. Only few tests were performed. But, we think they are important to give some insights about the relevance of our technique.

First, a user made a set of 10 trials with the Go-Go technique. This experiment may help us to determine the zones of VE in which the user is hesitating or badly piloting the virtual tool. The figure 7 (b) shows the evolution of the distance between the virtual tool to the target over time. It gives an example of an hesitation at distance 200 of the target: the user do not succeed to approach the target for about 1 second. The whole results show that an hesitation may occur from distance 50 to distance 200 of the virtual target. The same kind of results may be seen in the second case when the Go-Go technique is assisted by virtual ray (see Figure 7 (c)). It has led us to specify the scaled manipulation zone and precise manipulation zone of the FOLLOW-ME technique. In our experiments, the scaled manipulation zone if a square box of width 200 wheres the precise manipulation zone is in a box of width 100.

Our criterium of easiness may be validated by seeing the distance to target curve. We have done a 10 trials experiment with the FOLLOW-ME technique. The evolution of the distance to the target

for a trial is depicted in figure 7 (a). We see that the curve decreases regularly. This curve is parted into 3 zones:

- the left part of the curve shows a huge slope (this is associated with the free manipulation zone and its gain $K_N = 1$)
- the middle part of the curve shows a slight slope (this is associated with the scaled manipulation zone and its gain $K_S = 0.25$)
- the right part of the curve shows an exponential slope (this is associated with the precise manipulation zone)

The figure 8 gives the compared performances of the three techniques, in term of completion time of the "reaching an object" task.

- For the FOLLOW-ME technique, the mean completion time is 3.21 sec with standard deviation of 0.43 sec.
- For the Go-Go technique, the mean completion time is 5.28 sec with standard deviation of 0.68 sec.
- For the Go-Go technique assisted by virtual ray, the mean completion time is 4.89 sec with standard deviation of 1.92 sec.

As a preliminary result, we see that the FOLLOW-ME technique is faster than the Go-Go technique in both cases, without assistance and with visual assistance (virtual ray). An important fact is that the standard deviation of the completion time is the lowest. That means that the executed task is reproducible easily.

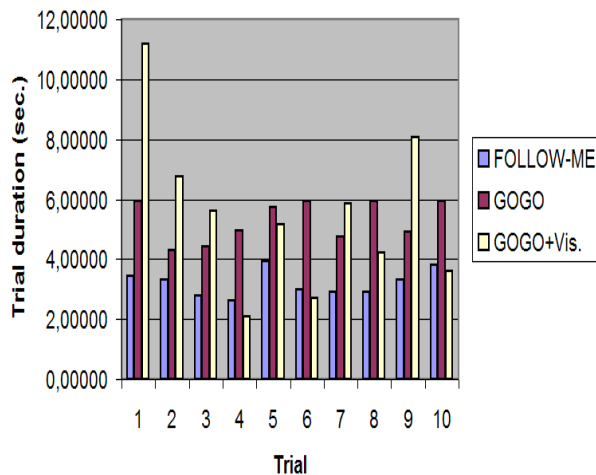

Figure 8: Comparison between the Go-Go, Go-Go assisted by virtual ray and FOLLOW-ME techniques (duration completion of the task)

5 Conclusion and perspectives

In this article, we have described a new interaction technique called *FOLLOW-ME* and specified its associated formal model. The main characteristics of this technique are:

- the splitting of the virtual environment into three zones (free manipulation, scaled manipulation and precise manipulation

zones) differing from each other by the *granularity of the interaction*;

- the use of virtual guides in the precise manipulation zone.

In order to have a preliminary validation of our technique, we have compared it with the Go-Go technique without assistance and with visual assistance (virtual ray), for a "reach an object" task. The first results show that the FOLLOW-ME technique permits to achieve the executed task faster than Go-Go technique. Besides, the completion time of the executed task is quite similar when comparing two different trials of the same user.

We have also given preliminary results about how it is possible to determine the volume of the scaled manipulation and precise manipulation zones in the FOLLOW-ME technique. In the following, we plan to build experiments in order to find a good compromise between the number of possible selected objects in a 3D VE and the easiness of selection of remote, small or dynamic objects in VE. This may be of high importance in a virtual 3D desktop project we have just begun.

We first plan to make extensive experiments for a selection task in order to show in which conditions our technique is really suitable. Ongoing experiments concern several issues such as selection and manipulation of remote, small or dynamic objects in virtual environments. Second, we aim to implement our technique for teleoperation tasks, mainly because the precision and easiness of virtual guides may be valuable characteristic in this case.

6 Acknowledgments

We wish to thank "Le Conseil Général De l' Essonne" and "CNRS" for funding this project.

References

- BOLT, R. 1980. Put-that-there: voice and gesture at the graphics interface. *Computer Graphics* 14, 3, 262–270.
- BOWMAN, D., AND HODGES, L. 1997. An evaluation of techniques for grabbing and manipulating remote objects in immersive virtual environments. In *Proceedings of Symposium on Interactive 3D Graphics*, ACM, 35–38.
- BOWMAN, D., JOHNSON, D., AND HODGES, L. 2001. Testbed evaluation of virtual environment interaction techniques. *Presence: Teleoperators and Virtual Environments* 10, 3, 75–95.
- BOWMAN, D., KRUIJFF, E., LAVIOLA, J., AND POUPLYREV, I. 2005. *3D user interfaces : Theory and Practice*. Addison-Wesley.
- FORSBERG, A., HERNDON, K., AND ZELEZNIK, R. 1996. Aperture based selection for immersive virtual environment. In *Proceedings of UIST'96*, 95–96.
- FREES, S., AND KESSLER, G. 2005. Precise and rapid interaction through scaled manipulation in immersive virtual environments. In *IEEE Virtual Reality 2005*, 99–106.
- GOBEL, M. 1996. Industrial applications of ves. *IEEE Computer Graphics and Applications* 16, 1, 10–13.
- JACOBY, R., FERNEAU, M., AND HUMPHRIES, J. 1994. Gestural interaction in a virtual environment. In *Proceedings of Stereoscopic Display and Virtual Reality Systems: The Engineering Reality of Virtual Reality*, 355–364.

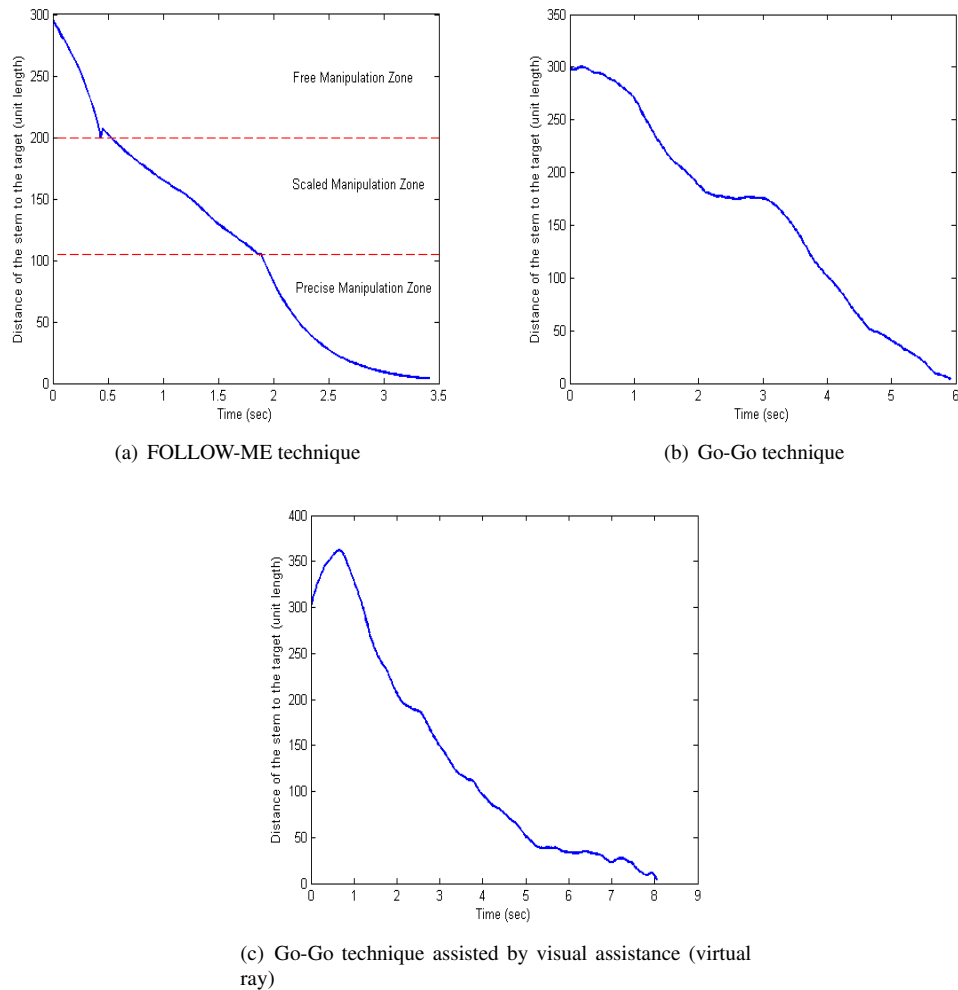

Figure 7: Evolution of the distance of the virtual tool to the target over time

LIANG, J. 1994. Jdcad: A highly interactive 3d modeling system. *Computers and Graphics* 18, 4, 499–506.

MINE, M., BROOKS, F., AND SEQUIN, C. 1997. Moving objects in space: exploiting proprioception in virtual environment interaction. In *Proceedings of SIGGRAPH'97*, 19–26.

OTMANE, S., MALLEM, M., KHEDDAR, A., AND CHAVAND, F. 2000. Active virtual guide as an apparatus for augmented reality based telemanipulation system on the internet. In *IEEE Computer Society - 33rd Annual Simulation Symposium ANSS2000*, 185–191.

OTMANE, S., MALLEM, M., KHEDDAR, A., AND CHAVAND, F. 2000. Ariti: an augmented reality interface for teleoperation on the internet. In *Advanced Simulation Technologies Conference (ASTC2000)*, 254–261.

PIERCE, J., FORSBERG, A., CONWAY, M., HONG, S., ZELEZNIK, R., AND MINE, M. 1997. Image plane interaction techniques in 3d immersive environments. In *Proceedings of Symposium on Interactive 3D Graphics*, 39–44.

POUPYREV, I., WEGHOST, S., BILLINGHURST, M., AND ICHIKAWA, T. Egocentric object manipulation object in virtual

environments: Empirical evaluation of interaction. *Proceedings of Eurographics'98* 17, 3.

POUPYREV, I., BILLINGHURST, M., WEGHORST, S., AND ICHIKAWA, T. 1996. The go-go interaction technique: Non-linear mapping for direct manipulation in vr. In *Proceedings of the 9th annual ACM symposium on User interface software and technology*, ACM Press, R. R. David Kurlander, Marc Brown, Ed., 79–80.

ROSENBERG, L. 1993. The use of virtual fixtures to enhance telemanipulation with time delay. In *Proceedings, ASME Winter Annual Meeting on Haptic Interfaces for Virtual environment and Teleoperator Systems*.

SONG, C., KWAK, N., AND JEONG, D. 2000. Developing an efficient technique of selection and manipulation in immersive v.e. In *VRST 2000*.

STOAKLEY, R., CONWAY, M., AND PAUSCH, R. 1995. Virtual reality on a wim: interactive worlds in miniature. In *Proceedings of CHI'95*, 265–272.