



HAL
open science

Fiber sensors multiplexing using vectorial wave mixing in a photorefractive crystal

Salvatore Di Girolamo, Roman V. Romashko, Yuri N. Kulchin, Jean-Claude Launay,
Alexei A. Kamshilin

► To cite this version:

Salvatore Di Girolamo, Roman V. Romashko, Yuri N. Kulchin, Jean-Claude Launay, Alexei A. Kamshilin. Fiber sensors multiplexing using vectorial wave mixing in a photorefractive crystal. *Optics Express*, 2008, 16 (22), pp.18040-18049. <10.1364/OE.16.018040>. <hal-00339225>

HAL Id: hal-00339225

<https://hal.science/hal-00339225v1>

Submitted on 4 Mar 2024

HAL is a multi-disciplinary open access archive for the deposit and dissemination of scientific research documents, whether they are published or not. The documents may come from teaching and research institutions in France or abroad, or from public or private research centers.

L'archive ouverte pluridisciplinaire **HAL**, est destinée au dépôt et à la diffusion de documents scientifiques de niveau recherche, publiés ou non, émanant des établissements d'enseignement et de recherche français ou étrangers, des laboratoires publics ou privés.



Distributed under a Creative Commons CC BY-NC-ND 4.0 - Attribution - Non-commercial use - No Derivative Works - International License

Fiber sensors multiplexing using vectorial wave mixing in a photorefractive crystal

Salvatore Di Girolamo,^{1,*} Roman V. Romashko,² Yuri N. Kulchin,² Jean-Claude Launay,³ and Alexei A. Kamshilin.¹

¹Physics Dept., University of Kuopio, P.O. Box 1627, FIN-70211, Kuopio, Finland

²Optoelectronics Lab., Institute of Automation & Control Processes, FEB RAS, Vladivostok, 690041 Russia

³Institute of Condensed Matter and Chemistry of Bordeaux- ICMCB/CNRS, University Bordeaux 1, 87 Avenue Dr A. Schweitzer, 33608 Pessac Cedex, France.

*Corresponding author: girolamo@messi.uku.fi

Abstract: We propose a novel multiplexing system for sensing of dynamic strains excited in different multimode optical fibers. Multiplexing of the sensors is implemented by using vectorial wave mixing technique in the reflection geometry of hologram formation in a photorefractive crystal of CdTe:V. We analyzed different mechanisms of the crosstalk between measuring channels and showed that system performance is strongly affected by residual stresses of the photorefractive crystal.

©2008 Optical Society of America

OCIS codes: (060.2370) Fiber optics sensors; (090.2880) Holographic interferometry; (090.4220) Multiplex holography.

References and links

1. T. J. Hall, M. A. Fiddy, and M. S. Ner, "Detector for an optical-fiber acoustic sensor using dynamic holographic interferometry," *Opt. Lett.* **5**, 485-487 (1980).
2. S. Di Girolamo, A. A. Kamshilin, R. V. Romashko, Y. N. Kulchin, and J.-C. Launay, "Sensing of multimode-fiber strain by a dynamic photorefractive hologram," *Opt. Lett.* **32**, 1821-1823 (2007).
3. S. I. Stepanov, "Adaptive interferometry: a new area of applications of photorefractive crystals" in *International trends in optics*, J. W. Goodman, ed. (Academic Press, Inc., New York, London 1991).
4. T. W. Murray, H. Tuovinen, and S. Krishnaswamy, "Adaptive optical array receivers for detection of surface acoustic waves," *Appl. Opt.* **39**, 3276-3284 (2000).
5. T. W. Murray and S. Krishnaswamy, "Multiplexed interferometer for ultrasonic imaging applications," *Opt. Eng.* **40**, 1321-1328 (2001).
6. P. A. Fomitchov, T. W. Murray, and S. Krishnaswamy, "Intrinsic fiber-optic ultrasonic sensor array using multiplexed two-wave mixing interferometry," *Appl. Opt.* **41**, 1262-1266 (2002).
7. S. Di Girolamo, A. A. Kamshilin, R. V. Romashko, Y. N. Kulchin, and J.-C. Launay, "Fast adaptive interferometer on dynamic reflection hologram in CdTe:V," *Opt. Express* **15**, 545-555 (2007).
8. A. Yariv and P. Yeh, *Optical waves in crystals* (Wiley, New York 1984).
9. A. A. Kamshilin and A. I. Grachev, "Adaptive interferometer based on wave mixing in a photorefractive crystal under alternating electric field," *Appl. Phys. Lett.* **81**, 2923-2925 (2002).
10. A. A. Kamshilin, J. Frejlich, and L. Cescato, "Photorefractive crystals for the stabilization of the holographic setup," *Appl. Opt.* **25**, 2375-2381 (1986).

1. Introduction

In many practical situations (e.g. vibration sensing in industrial environments) it is desirable to use a multiplexing sensor in order to address many transducers to many points in the monitored area. As known [1,2], an optical fiber itself can serve as a sensitive element for detection of small dynamic stresses caused by a change of a chosen physical parameter, such as mechanical displacement, pressure, electric field, etc. These dynamic stresses result in modulation of the phase of light transmitted through the fiber. Detection of the phase modulation is usually performed by means of an interferometer. However, an unstable environment also affects the light phase, which typically varies more slowly but with higher

amplitude than the phase modulation caused by the physical parameter to be measured. To achieve high sensitivity of measurements under unstable environments, the interferometer must be capable of adapting these slowly varying phase changes. In the case of multiplexed fiber sensors, each fiber (each measuring channel) should be supported with its own stabilization system, which makes the whole arrangement very complex and expensive.

It is well known that two-wave mixing in photorefractive crystals (PRC) provides a simple and elegant implementation of adaptive interferometer for measuring small phase modulation [3]. In this technique, the reference and object beams are coupled because of mutual self-diffraction from a dynamic hologram continuously recorded in PRC by these beams. This coupling leads to the phase-to-intensity transformation and it automatically stabilizes the working point of the interferometer. Moreover, the holographic nature of the beam coupling allows an efficient use of multimode fibers in the interferometer [1,2]. As has recently been proposed [4-6], a single photorefractive crystal can be used for multiplexing several adaptive interferometers. In the proposed configurations, several object beams reflected from different parts of a specimen [4,5] or emerging from different fibers [6] are coupled with a single reference beam in the transmission geometry when all the interacting beams enter the same face of the PRC sample. However, such geometry is characterized by appreciable crosstalk between the channels due to object-to-object beam-coupling since any pair of the object beams is capable of creating their own dynamic hologram. Moreover, a strong ac-external electric field must be applied to the crystal to enhance the beam coupling in the transmission geometry. In this paper we describe a simpler geometry of multiple beams coupling in PRC, which possesses much lower crosstalk between the channels and does not require the application of any external electric field. Moreover, we have analyzed the physical mechanisms, which could lead to the crosstalk between different measuring channels.

2. Vectorial wave mixing in the reflection geometry for sensors multiplexing

In our configuration, the single reference beam enters the crystal from one face of the PRC sample while multiple object beams are introduced from the opposite face of the sample to be overlapped with the reference beam, as shown in Fig. 1. Each object beam constitutes a pair with the reference beam in PRC, and each pair forms a dynamic hologram of the reflection type. The high spatial frequency of the reflection holograms provides a strong enough diffusion field to ensure high sensitivity of the interferometer to the phase excursions, even without an external electric field [7]. We use a fast photorefractive crystal of CdTe:V, which belongs to the cubic symmetry group of $\bar{4}3m$. Efficient coupling of light beams in these crystals via the reflection hologram occurs when the interacting waves propagate approximately along one of the principal crystallographic axes $\langle 100 \rangle$ [7]. In this configuration interference of any pair of the object beams forms a transmission hologram with the grating vector (and consequently, with the space-charge-field vector) almost orthogonal to the axis of propagation. Such a grating should not couple the object beams because of the specific feature of the electro-optic tensor of crystals of the cubic symmetry: the transverse electric field does not change the propagation constant of the light wave when it propagates along the principal axis [8]. Therefore, we expect that object-object dynamic hologram should not contribute to the crosstalk among the measuring channels unless internal stresses are present inside the crystal sample.

Another advantage of sensors multiplexing in the reflection geometry is the possibility to arrange larger number of channels in one crystal because the angle of incidence of the object beams may vary arbitrarily in two dimensions. In contrast, only one plane of incidence for all object beams is allowed in the transmission geometry. For clearness of the axonometric drawing, in Fig. 1 we show only four beams which interfere with the reference beam but the number of object beams can be easily increased.

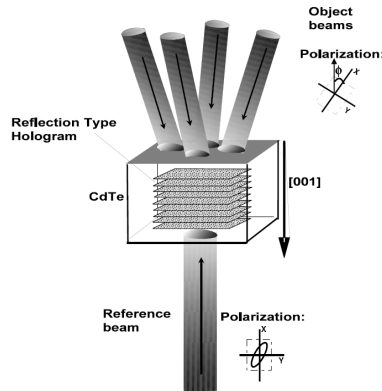

Fig. 1. Schematic of multiple beam interaction by using vectorial wave-coupling in the reflection geometry in a single CdTe crystal when the interfering beams propagate at small angle to the principal axis [001]. Each object beam (linearly polarized) creates a dynamic hologram of the transmission type with a common reference beam (elliptically polarized).

To ensure linear phase-to-intensity transformation, an interferometer has to maintain the quadrature conditions where the relative phase between the reference and object waves is equal to $\pi/2$. For a beam mixer using dynamic hologram in photorefractive crystal the phase difference between the diffracted reference and transmitted object beams is defined by the mechanism of the hologram formation. As it was shown in [9], it is possible to fulfill the quadrature conditions for hologram recorded in the diffusion regime (without external electric field) only when the polarization states of the interfering beams are different. This technique is referred to as vectorial wave mixing [9]. We have applied it to implement adaptive interferometric system for stabilization of multiplexed fiber-optic sensors by using reflection-type dynamic holograms in the photorefractive crystal of CdTe:V. In the case when the object beams are speckled waves emerged from a multimode fiber, it is convenient to set the linear polarization for all the object beams and the elliptical polarization for the reference beam as shown in Fig. 1. Consequently, all the object beams are of the same linear polarization state.

3. Experimental

Experimental study of the crosstalk between different measuring channels in the proposed multiplexed-sensors system was carried out in the simplified set-up using only two object beams and one common reference beam. Layout of the experimental set-up is shown in Fig. 2. A light beam generated by a CW Nd:YAG laser ($\lambda = 1064$ nm) is divided into two beams. One of them is used as a reference and the other is split in two beams, which are launched into two separate multimode fibers. Each fiber has a core of $550 \mu\text{m}$ in diameter, numerical aperture of 0.22, and the length of 7.5 m. Both fibers are tightly wound over different piezoelectric cylinders. By applying a voltage to the cylinders, we introduce strains into the fibers, which lead to the phase modulation of the output speckled wave. Both waves emerged from the fibers are focused by respective lenses into the same part of PRC where they are mixed with the reference beam directed from the other side of the crystal. The object beams are incident to the PRC sample at an angle of about 15 degrees in respect to the [001]-axis. The diameters of the two objects and of the reference beams at the input faces were 1 mm.

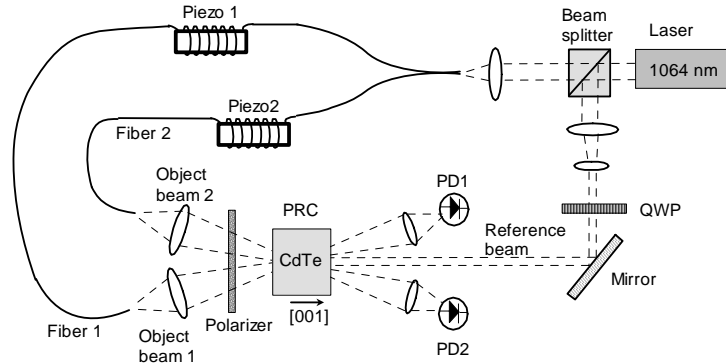

Fig. 2. Layout of the experimental setup for crosstalk measurements when only two measuring channels are incorporated. Piezoelectric cylinders are used for excitation of dynamic strains in multimode fibers with the core diameter of 550 μm . Speckled beams emerged from both fibers are directed in the same volume of the crystal as the reference beam.

The technique of vectorial wave mixing [9], in which the polarization state of the reference beam is different from that of the object beams, was used to maximize the sensitivity of the adaptive interferometer to small phase excursions. A single polarizer is positioned in front of the crystal to select the linear polarization state for all the object beams. The polarization state of the reference beam is controlled by a quarter-wave plate (QWP in Fig. 2). Each object beam transmitted through the crystal is entirely collected into the active area of the respective photodiode to measure the intensity modulation of the respective beam after its coupling with the reference beam. By applying sinusoidal voltage at the frequency f to any piezoelectric cylinders, we modulate the phase of light transmitted through its respective fiber. This phase modulation results in appearance of a harmonic signal the same frequency f as the voltage applied in the similar way as we recently reported for a multimode fiber-sensor with an adaptive interferometer using dynamic photorefractive hologram of the reflection type [2]. Typical response of the photodiode is shown in Fig. 3. Pure sinusoidal shape of the signal confirms that the strains in the fiber are harmonically modulated.

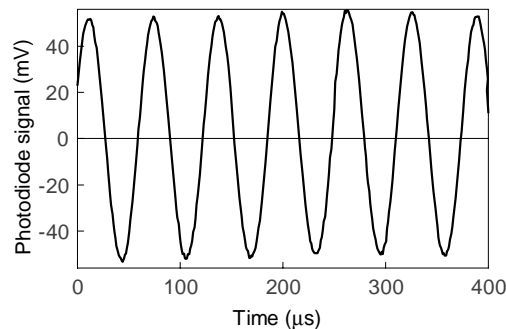

Fig. 3. Oscilloscope trace of the photodiode (PD1) response when sinusoidal voltage at the frequency $f = 15$ kHz is applied to the respective piezoelectric cylinder (piezo 1 in Fig. 2).

To estimate the crosstalk between two channels, we modulated the strains (at the frequency f) of only one fiber (the object beam 1) but measured the response of the photodiode (PD2) corresponding to another fiber, which was non-excited. The measurements were done by means of a lock-in amplifier. Since the modulation frequency is not known a priori in most of the applications, the response of the second photodiode at any frequency on the excitation of the first fiber should be considered as a crosstalk. To separate the crosstalk from the noise, we measured the response at the first (f) and second ($2f$) harmonics of the

excitation frequency because these are the highest expected when the first channel is excited at the frequency f . Quantitatively, the crosstalk can be evaluated as

$$\alpha_{S_2} = \frac{|S_2(f)| + |S_2(2f)|}{|S_1(f)|}, \quad (1)$$

where $S_1(f)$ is the amplitude of response of the first photodiode on the excitation of the first fiber at the frequency f , and $S_2(f)$ and $S_2(2f)$ are the modulations amplitudes of the signal from the second photodiode at the first and second harmonics, respectively.

4. Crosstalk estimation

4.1 Crosstalk dependence on the reference beam intensity

It was previously suggested [4-6] that the main mechanism of the crosstalk between different channels in multiplexed dynamic interferometer with PRC is the coupling of two object beams via the transmission-type hologram recorded by the object beams. In the beams-interaction geometry used in our experiments, which is depicted in Fig. 2, such a hologram should not couple the object beams regardless of the orientation of its vector. However, we detected presence of both the first (f) and second ($2f$) harmonics in the output current from the photodiode PD2 when the dynamic strains at the frequency f were excited only in the first fiber. Amplitudes of these harmonics depend on the amplitude of the fiber-strains modulation. In addition, the crosstalk depends on the intensity of the reference beam. This dependence is shown in Fig. 3 from which one can see that the amplitude of the first harmonic is even bigger than that of the second harmonic. Note that the maximal photocurrent modulation is observed for zero-intensity of the reference beam, i.e. when no main reflection hologram is recorded but there is the transmission hologram created by two object beams. Possible reasons of the observed behavior of the crosstalk are discussed below.

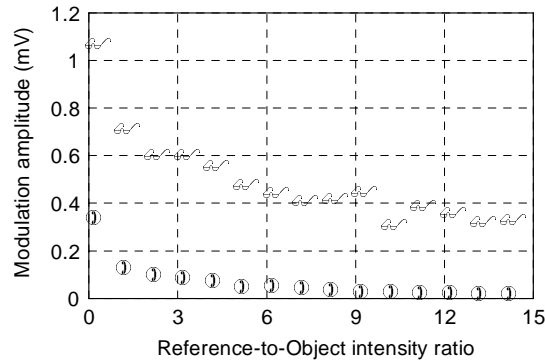

Fig. 4. Dependence of the signal from PD2 on the intensity ratio of the reference beam and the object beam 1. Measurements were carried out at the crystal area with maximal stresses. Periodical strains were excited in the fiber 1 at the frequency f so that the amplitude of the phase modulation of the object beam 1 is 1.1 radians. The object beam 2 had no modulation and its intensity at the crystal input was equal to that of the object beam 1. Squares are peak-to-peak modulation of the photocurrent at the frequency f and circles are the modulation amplitude at the frequency $2f$.

4.2 Crosstalk due to coupling via transmission hologram

As we pointed out above, self-diffraction from the dynamic hologram created by two object beams is forbidden in our configuration. However, internal stresses inside our particular sample of CdTe:V may change the situation. These stresses modify the local symmetry of the crystal thus allowing beam coupling via transverse electrooptic effect. The existence of these stresses was confirmed in a control experiment by placing the crystal between two crossed polarizers: after uniform illumination some areas of the crystal are more transparent than the

others. Dependence of Fig. 4 was measured when the object beams are directed to the sample's area containing the strongest internal stresses, which is the most transparent area of the crystal in the crossed polarizers. In the crosstalk measurements both object beams have the same linear polarization. It is well known [3,10] that coupling of these beams via dynamic hologram recorded in the diffusion regime should lead to the intensity modulation at the frequency $2f$ when the phase of one beam is modulated at the frequency f . Linear phase-to-intensity transformation is not expected in these conditions. However, we have also observed the crosstalk at the frequency f as it is shown in Fig. 4. This can be explained by presence of the external stresses in the crystal. Since the stresses are unevenly distributed over the crystal, the object beams may have different polarization states in some parts within the crystal thus resulting in the linear phase-to-intensity transformation as it occurs in the configuration of vectorial wave mixing [9].

This model of the crosstalk was confirmed by directing all the interacting beams in the sample's area with the smallest stresses. In this case much smaller signal at the first harmonic was detected as it is shown in Fig. 5. At the absence of the reference beam the intensity modulation at the frequency f has very small amplitude but it rises with increasing intensity of the reference beam and finally saturates at the level, which is lower than that in the crystal area with strong internal stresses. It was found that the amplitude of the first harmonic in the area with minimal stresses does not change when the object beam 2 is blocked. Therefore, we attribute it to scattering of the object beam 1 in the direction of the detector PD2. Detailed explanation of the observed behavior is given in following subsection.

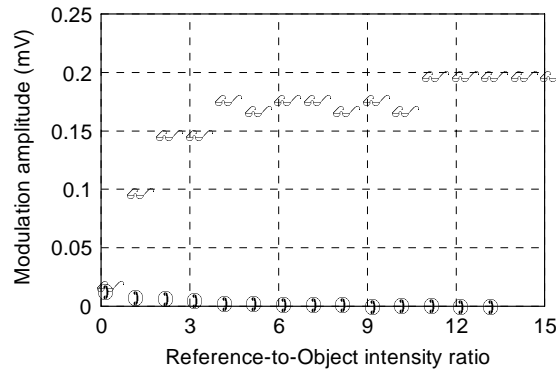

Fig. 5. Amplitude of the PD2-photocurrent modulation as a function of the reference-to-object beams intensity ratio measured in the crystal area with the smallest internal stresses. Other experimental parameters are the same as for measurements shown in Fig. 3. Squares are peak-to-peak modulation of the photocurrent at the frequency f and circles are the modulation amplitude at the frequency $2f$.

4.3 Intensity modulation of object beams

As we recently reported in [2], the largest source of noise in a dynamic-strains sensor with multimode fiber is polarization instability of dynamic speckle pattern emerged from the fiber. This noise manifests itself as intensity modulation of any object beam at the input in the crystal. By installing the polarizer, which is essential in any configuration of waves coupling in photorefractive crystals, we select the linear component from various polarization states, averaging these components over the set of speckles. Since the number of speckles emerged from the fiber is finite, any external impact (like temperature, pressure, or bending, including periodically introduced strains) affects the fiber, resulting in change of both the size and polarization state of each individual speckle thus leading to changes in the magnitude of the averaged polarization component. By this way periodically modulated strains of any multimode fiber produce not only phase but also intensity modulation at the frequency of f . The amplitude of this modulation is unstable because it depends on the environmental conditions. Moreover, it cannot be compensated for by a dynamic hologram. The larger the

core of multimode fiber, the smaller such kind of intensity modulation [2]. It is easy to detect this modulation by the photodiode PD1 of the set-up shown in Fig. 2 when the strains are modulated in the fiber 1 but both the object beam 2 and reference are blocked.

Some part of the object beam 1 is scattered in the direction of PD2 due to imperfections at the surface and/or in the volume of the photorefractive crystal. Since the intensity of the object beam has small component modulated at the frequency f , we measure a small signal at the first harmonic from PD2 when both the reference and second object beams are blocked (see the origin of the abscissa axis in Fig. 5). If the reference beam is switched on, it interferes with the scattered part of the first object beam and creates the reflection-type hologram in PRC. After being diffracted from this hologram, the reference beam is $\pi/2$ -phase shifted in respect to the scattered part of the object beam 1 because both beams have different polarization states optimized for vectorial wave mixing [9]. Therefore, phase modulation of the scattered part of the object beam 1 is linearly transferred into intensity modulation, which is detected by the photodiode PD2. This explains ten-fold increase of the modulation at the first harmonic shown in Fig. 5 and its independence from the presence of the object beam 2.

4.4 Intensity modulation of the reference beam

There is still another possible mechanism of the crosstalk leading to the intensity modulation at the first harmonic, which may occur even without direct object-to-object coupling or light scattering. It relates to the intensity modulation of the reference beam. Such a modulation inevitably appears due to its coupling with the phase-modulated object beam 1. Note that the reference-beam intensity is modulated at the first harmonic because of the fulfillment of the quadrature conditions after anisotropic diffraction of differently polarized beams from the reflection-type dynamic hologram recorded in the diffusion regime [7]. The reference beam is also diffracted in the direction of the photodiode PD2 from the second reflection-type hologram. Therefore, it contributes to the modulation of the PD2-photocurrent at the first harmonic. Let us estimate this contribution as a function of the reference beam intensity.

For the hologram recorded by the reference beam and object beam 1, the object beam 2 acts as an additional uniform illumination leading to diminishing of the interference-pattern visibility. Therefore, in the approximation of small diffraction efficiency [10], the modulated part of the intensity of both the reference and the object beam 1 is expressed as

$$S_1(f) = 2A_1 \frac{I_R I_{S1}}{I_R + I_{S1} + I_{S2}} \psi_d. \quad (2)$$

Here I_R is the intensity of the reference beam; I_{S1} and I_{S2} are the intensities of the object beams 1 and 2, respectively; ψ_d is the amplitude of the phase modulation (in radians); and A_1 is the proportionality coefficient, which takes into account the crystal geometry, amplitude of the space-charge field, and the polarization states of the interacting beams. Note that the amplitude of the intensity modulation of the reference beam $S_1(f)$ in Eq. 2 is exactly the same as the intensity modulation detected by the photodiode PD1, which is considered as an informative signal. The reference beam simultaneously diffracts from the second hologram thus contributing to the intensity modulation at the frequency f detected by the photodiode PD2, which originates from the modulated part $S_1(f)$ of the reference beam:

$$S_2(f) = A_1^2 S_1(f) \frac{I_R I_{S2}}{(I_R + I_{S1} + I_{S2})^2} = 2A_1^3 \frac{I_R^2 I_{S2} I_{S1}}{(I_R + I_{S1} + I_{S2})^3} \psi_d. \quad (3)$$

In Eqs. 2 and 3, the term $A_1^2 I_R I_{S2} / (I_R + I_{S1} + I_{S2})^2$ has the physical meaning of the diffraction efficiency of a dynamic hologram, which explicitly shows dependence on the visibility of the respective interference pattern. Analysis of Eq. 3 shows that $S_2(f)$ is zero when $I_R = 0$, then it reaches its maximum at $I_R/I_{S1} = 4$ (if I_{S1} is equal to I_{S2} as we have in our experiment), and it again approaches to zero at large intensity of the reference beam. However, the experimental curves show continuous either decreasing or increasing while they

obtained in the crystal areas with or without stresses, respectively. Therefore, we conclude that this mechanism of the crosstalk is negligible in our sample of CdTe:V comparing with scattering from crystal imperfections and consequent diffraction from the object-to-object hologram.

In the crystal area with strong internal stresses some parts of both object beams may still have the same polarization states. The object beam 1 is phase modulated with the modulation amplitude of ψ_0 . Its coupling with the part of the object beam 2 having the same polarization state via the photorefractive hologram recorded in the diffusion regime results in quadratic phase demodulation [3,10]. This is the mechanism, which explains appearance of the PD2-photocurrent modulation at the second harmonic. The reference beam just decreases the coupling between two object beams and the modulated part of the intensity at the photodiode 2 can be written as [10]:

$$S_2(2f) = 2A_2 \frac{I_{S1}I_{S2}}{I_R + I_{S1} + I_{S2}} \psi_d^2. \quad (4)$$

Here A_2 is the proportionality coefficient, which is different from A_1 in Eq. 2 because they describe efficiency of holograms of different types. According to Eq. 4, the amplitude of the photocurrent component modulated at the frequency of $2f$ is maximal at $I_R = 0$ and then it continuously decreases with increasing of the reference-beam intensity. The same behavior is observed in the experiment as one can see in Fig. 4.

4.5 Complete crosstalk

As we pointed out in Sect. 3, the complete crosstalk between two measuring channels includes amplitudes of the modulation at the frequencies f and $2f$, when the phase of the object beam 1 is modulated at the frequency f . Dependence of the normalized complete crosstalk (defined by Eq. 1) on the intensity ratio of the reference-to-object beam is shown in Fig. 6 for two areas of the crystal containing the strongest and smallest internal stresses.

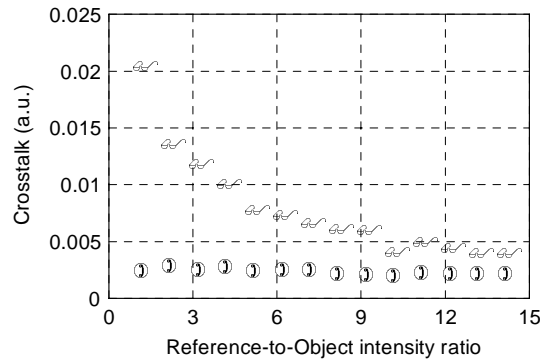

Fig. 6. The crosstalk parameter α_{S2} as a function of the reference-to-object beams intensity ratio. Measurements were carried out in the crystal area with internal stresses (squares) and without stresses (circles).

As one can see the crosstalk between the channels in the area of the crystal with strong internal stresses is much higher than that in the area free of stresses. Even in the stressed part of the crystal, the crosstalk is smaller compare with the system configuration with all transmission holograms. This is certainly advantage of the proposed configuration in which dynamic holograms are recorded in the reflection geometry. The normalized crosstalk parameter α_{S2} is very convenient for estimation of the number of multiplexed measured channels supported by dynamic holograms recorded in the same volume of the photorefractive crystal. It is worth noting that in any case the crosstalk is diminishing when the intensity of the reference beam becomes much stronger than that of the object beams.

5. Discussion

In addition to the phase modulation, dynamic strains excited in a multimode fiber result in the intensity modulation of the object beam after the polarizer. The intensity of the input object beam is modulated at the either first or second harmonics of the excitation frequency but it is characterized by unstable amplitude of modulation. Dynamic hologram in a photorefractive crystal serves for both transformation of phase- to intensity-modulation and compensation for slow varying instabilities thus forming the informative signal $S_1(f)$. However, the hologram cannot compensate for instabilities of the input intensity modulation of the object beam [2]. Fortunately, these instabilities are smaller than the amplitude of the stabilized informative signal and their maximal value is proportional to the amplitude of the strains excitation. This allows us to detect very small dynamic strains excited in the optical fiber. The minimal detectable amplitude of dynamic strains excited in a 1-cm piece of the multimode fiber with the core-diameter of $550 \mu\text{m}$ is as small as $0.01 \mu\epsilon$ [2].

When additional measuring channel is added to the optical system, the sensitivity of each channel to strain detection is decreasing. There are two reasons of this decreasing: (i) noise increasing due to the crosstalk between channels and (ii) signal decreasing caused by diminished efficiency of dynamic hologram. Let us first discuss the crosstalk influence. Considering the worst situation, we suppose that the phase of the first object beam is modulated with the amplitude of 1.1 radians (which leads to the maximal intensity modulation in dynamic interferometer) at the frequency f and estimate the detection limit of the second channel for the signal at the same frequency. This modulation according to Fig. 6 leads to the crosstalk noise of -23 dB at the crystal area with stresses for large intensity ratio. Therefore, the phase modulation in the second channel with peak-to-peak amplitude of 5×10^{-3} radians results in $\text{SNR} = 1$. The polarization noise associated with this phase modulation is much smaller than the crosstalk noise. The minimal detectable amplitude of dynamic strains in this case is defined by the crosstalk noise and it is $0.06 \mu\epsilon$ for excitation of 1 cm of the multimode fiber. Since the crosstalk is two times smaller in the crystal area with the smallest stresses (see Fig. 6), the strains with the amplitude of $0.03 \mu\epsilon$ can be detected in this part of crystal using two-channel system. Evidently, the crosstalk noise increases in each channel if we add more fibers to the system. Therefore, the smallest detectable strain becomes higher that decreases the dynamic band of strains measurements.

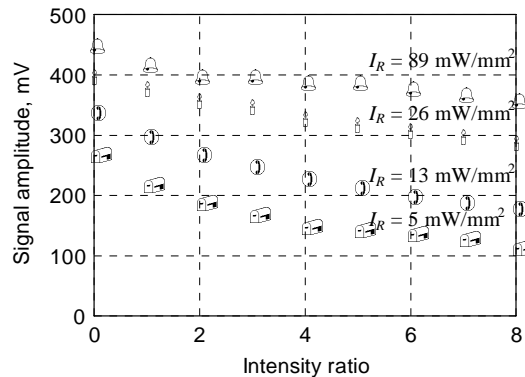

Fig. 6. Amplitude of the signal detected by PD1 as a function of the intensity ratio of two object beams: I_2/I_1 . The intensity of the reference beam (I_R) is used as a parameter. Dynamic strains were excited in the fiber 1 so that the peak-to-peak amplitude of the phase modulation of the object beam 1 is 1.1 radians. The intensity of the object beam 1 is 5 mW/mm^2 everywhere.

Each object beam added to the measuring system also affects the amplitude of the informative signal through the visibility of the interference pattern as it is presented by Eq. 2. Influence of multiplexed object beams on the amplitude of the informative signal was studied

experimentally. Here we measured the amplitude of the signal $S_1(f)$ from the photodiode PD1 as a function of the intensity I_{S2} of the object beam 2 when dynamic strains are excited in the fiber 1 (see Fig. 2). Assuming that in the multiplexed system intensities of different object beams are equal each other, the ratio I_{S2}/I_{S1} simulates the number of multiplexed channels. The experimental results are presented in Fig. 6 for different intensities of the reference beam. As expected from Eq. 2, diminishing of the informative signal $S_1(f)$ is smaller when $I_R \gg I_S$. For $I_R = 16I_{S1}$, the signal amplitude is decreasing by only 1.0 dB after adding 8 channels. It is much smaller than increasing of the crosstalk noise but both these factors affect the dynamic band of measurements. For each channel the measuring band would be 14 dB if the system incorporates 10 object beams mixed in the crystal area with the smallest stresses.

6. Conclusions

A multiplexed interferometric sensor has been developed that allows for simultaneous detection of dynamic strains excited in different multimode optical fibers. Multiplexing of adaptive interferometers is implemented in a single photorefractive crystal by using vectorial wave mixing in the reflection geometry of hologram recording without any external field. This configuration has potentially low crosstalk between the measuring channels. It is shown however that residual stresses and imperfections of particular photorefractive crystal of CdTe:V are main reasons of the crosstalk in the proposed system. Nevertheless, it is possible to design sensor consisting of 10 adaptive interferometers in the same volume of the crystal with diminished dynamic band of measurements. Use of photorefractive crystals with higher quality could improve the parameters of the multiplexed sensor.

Acknowledgments

Authors from Finland thank the Academy of Finland for financial support in the frames of the project 118487. Authors from Russia acknowledge the Russian Foundation for Basic Research for the grant 07-02-91015. Jean-Claude Launay thanks for financial support of European Space Agency under the ESA contract number 14240/NL/SH.