



**HAL**  
open science

# Intersection number and topology preservation within digital surfaces

Sébastien Fourey, Rémy Malgouyres

► **To cite this version:**

Sébastien Fourey, Rémy Malgouyres. Intersection number and topology preservation within digital surfaces. *Theoretical Computer Science*, 2002, 283 (1), pp.109-150. 10.1016/S0304-3975(01)00059-7 . hal-00338929

**HAL Id: hal-00338929**

**<https://hal.science/hal-00338929v1>**

Submitted on 27 Jun 2024

**HAL** is a multi-disciplinary open access archive for the deposit and dissemination of scientific research documents, whether they are published or not. The documents may come from teaching and research institutions in France or abroad, or from public or private research centers.

L'archive ouverte pluridisciplinaire **HAL**, est destinée au dépôt et à la diffusion de documents scientifiques de niveau recherche, publiés ou non, émanant des établissements d'enseignement et de recherche français ou étrangers, des laboratoires publics ou privés.

# Intersection Number and Topology Preservation within Digital Surfaces

Sébastien Fourey and Rémy Malgouyres

GREYC, ISMRA, 6 bd Maréchal Juin 14000 Caen - France,  
{Fourey,Malgouyres}@greyc.ismra.fr

---

## Abstract

In this paper, we prove a new result of digital topology which state that the digital fundamental group – a notion previously introduced by Kong in [Kon89] – is sufficient to characterize topology preservation within digital surfaces. This proof involves a new tool for proving theorems in this field : the Intersection Number which counts the number of real intersections between two surfels loops lying on a digital surface. The main property of the intersection number and the reason why it is useful is the following : the intersection number between two paths does not change after any *continuous* deformation applied to the paths.

*Key words:* Digital topology, digital surfaces, digital paths, topology preservation.

---

## Contents

1	Definitions and preliminaries	3
1.1	Basic notions	3
1.2	Digital surfaces	4
1.3	Surfels Neighborhood, surfel paths	4
1.4	Simple surfels, Homotopy	6
1.5	The fundamental group of a digital surface	6
1.6	Euler characteristics	7
2	Intersection Number of paths	8
2.1	Definition	8
3	Main properties	11
4	Useful Properties	13
4.1	Change of sign with path inversion	13
4.2	Commutativity property	15
4.3	An additive property	21
5	Proof of the main Theorems	22

5.1	Another definition for the homotopy of $v$ -paths	23
5.2	Proof of Theorem 2 when $(n, \bar{n}) = (e, v)$	25
5.3	Another definition of homotopy for $e$ -paths	26
5.4	Intersection number of $e$ -loops	28
5.5	Proof of Theorem 2 when $(n, \bar{n}) = (v, e)$	28
6	Topology preservation within digital surfaces	29
6.1	A new theorem about homotopy in digital surfaces	29
6.2	First step of the proof	31
6.3	Second step of the proof	32
6.4	Edgel borders of a connected subset $X \subset \Sigma$	33
6.5	Free group	33
6.6	Free group element associated with a path	34
6.7	Important lemmas	36
7	Proof of Theorem 5	39
	References	40

## Introduction

In [Kon89], Kong introduced the digital fundamental group as a criterion for topology preservation in the digital space  $\mathbb{Z}^3$ . The question being “*When some set  $Y$  can be obtained by applying an homotopic thinning algorithm to another set  $X$  ?*”. Indeed, whereas a simple necessary condition considering holes in objects of  $\mathbb{Z}^2$  exists, the 3D case is not so trivial.

Furthermore, in the 2D case, topology preservation has shown to be a very basic and essential tool in pattern recognition and classification of objects represented in a planar grid. Thus, the topology preservation in the 3D case is a very important question if we expect to develop useful and efficient tools for 3D images analysis. Many authors have worked on homotopic thinning algorithms from which a simple notion of homotopy between digital sets can be derived (see [Kon89], [Ber94] or [Kon95]). Now a question remains about existence of a usable algorithm to decide if a given 3D set can be obtained by homotopic thinning of another one.

Today, a necessary condition  $\mathcal{P}(X, Y)$  can be given in terms of properties of the fundamental group morphism induced by inclusion of sets, and inclusion between cavities of the objects.

Now, another kind of digital objects is heavily used for image visualization and analysis : *digital surfaces*. Such objects are defined as the “visible” boundaries of a 3D object represented as a set of unit cubes (or *voxels*). These surfaces are constituted by unit 2D squares so called *surfels*. For example, such objects have been used in [ML98] to extract some anatomical informations from Nuclear Magnetic Resonance (NMR) images.

In [ML98], authors have proved that a similar criterion to the condition  $\mathcal{P}$  previously mentioned, using the digital fundamental group and intersection between “holes”, is a

*necessary and sufficient* condition for homotopy between parts of digital surfaces. *Holes* here denote connected components of the complement of a part  $X$  of a digital surface  $\Sigma$ . Since this paper, it was a conjecture that the condition about the “holes” was itself a consequence of the condition relative to the fundamental groups except in a very particular case. The purpose of this paper is to state and prove this result and then give a new Theorem about homotopy between subsets of a digital surface (Section 6). This leads to a very comprehensive new characterization which shows the ability of the fundamental group to completely characterize homotopy within digital surfaces.

On the other hand, the lack of tools for studying homotopy classes of paths, which are elements of the fundamental group, brings us to consider a new tool : the Intersection Number. This number, which counts oriented intersections between two kinds of paths, is invariant under any continuous deformation of the paths. Then, it can be used for example to show that two paths are not homotopic. Similarly, it can also be used to show that a path cannot be continuously deformed into a *trivial path* (i.e. a path reduced to a single surfel). This property can be seen as a generalization of the notion introduced in [RN97] where Rosenfeld and Nakamura study the properties of digital curves in 2D, considering for example curves surrounding a 2D hole. In our case, we have studied curves surrounding *tunnels* and this appears as an intermediate step between 2D and 3D cases. Note that the possible numbers of real intersections between closed curves drawn on a digital surface is related to the genus of the surface. Indeed, it is for example possible to draw two curves wich intersect only one time on the surface of a solid torus whereas this is impossible on a sphere. The intersection number, which is defined here, allows such considerations in the digital field.

The definition of the Intersection Number is given in subsection 2.1, the main properties are stated in Section 3 and their proofs are given in 5. In the section 6 we use this new tool and prove the above mentioned theorem on the characterization of homotopy between sets using the fundamental group.

## 1 Definitions and preliminaries

### 1.1 Basic notions

The context of this paper is *digital surfaces*. In order to define what we call a digital surface, we must recall few notions of digital topology. First, we consider objects as subsets of the 3 dimensional space  $\mathbb{Z}^3$ . Elements of  $\mathbb{Z}^3$  are called *voxels* (short for “volume elements”). The set of voxels which do not belong to an object  $O \subset \mathbb{Z}^3$  constitute the complement of the object and is denoted by  $\bar{O}$ . Any voxel can be seen as a unit cube centered at a point with integer coordinates  $v = (i, j, k) \in \mathbb{Z}^3$ . Now, we can define some binary symmetric antireflexive relations between voxels. Two voxels are said *6-adjacent* if they share a face, *18-adjacent* if they share an edge and *26-adjacent* if they share a vertex. For topological considerations, we must always use two different adjacency relations for an object and its complement. We sum this up by the use of a couple  $(n, \bar{n})$

with  $\{n, \bar{n}\} = \{6, 18\}$ , the  $n$ -adjacency being used for the object and the  $\bar{n}$ -adjacency for its complement. By transitive closure of these adjacency relations, we can define another one : connectivity between voxels. We define an  $n$ -path  $\pi$  with a length  $k$  from a voxel  $a$  to a voxel  $b$  in  $O \subset \mathbb{Z}^3$  as a sequence of voxels  $(v_i)_{i=0, \dots, k}$  such that for  $0 \leq i < k$ , the voxel  $v_i$  is  $n$ -adjacent or equal to  $v_{i+1}$ , with  $v_0 = a$  and  $v_k = b$ . Now we define connectivity : two voxels  $a$  and  $b$  are called  $n$ -connected in an object  $O$  if there exists an  $n$ -path  $\pi$  from  $a$  to  $b$  in  $O$ . This is an equivalence relation between voxels of  $O$ , and the  $n$ -connected components of an object  $O$  are equivalence classes of voxels according to this relation. Using this equivalence relation on the complement of an object we can define a *background component* of  $O$  as an  $\bar{n}$ -connected component of  $\bar{O}$ .

## 1.2 Digital surfaces

In this paper, we are interested by surfaces constituted of the boundary between a 6-connected or 18-connected subset  $O$  of  $\mathbb{Z}^3$ , and  $V$  which is one of its background components. As in [Udu94] we first define the *border* between  $O$  and  $V$  by:

$$\delta(O, V) = \{(a, b) \mid a \in O, b \in V \text{ and } a \text{ is } 6\text{-adjacent to } b\}$$

The set  $\Sigma = \delta(O, V)$  is called a *digital surface* and has the Jordan property (according to the definition given in [Udu94]). Each couple  $(a, b)$  of  $\Sigma$  is called a *surfel* (short for surface element) and can be seen as the common face shared by two 6-adjacent voxels, the first one belonging to the object, the second one to its background. Note that such a face is oriented according to the outward normal and this definition of a surfel is more restrictive than the classical one. In fact, we call a *voxel face* the unit square shared by any two 6-adjacent voxels, but a surfel is the oriented common face of two 6-adjacent voxels, where the first one is a voxel of  $O$  and the second one is a voxel of  $V$ .

In the sequel of this paper,  $\Sigma = \delta(O, V)$  is a digital surface.

## 1.3 Surfels Neighborhood, surfel paths

A surfel in a digital surface shares a given edge with at most three other surfels. We can define an adjacency relation between surfels, which depends on the adjacency considered for the object (6 or 18), in such a way that a surfel has exactly four neighbors, one per edge. The definition of this classical regular graph on  $\Sigma$  can be found for instance in [RKW91], and is as follows :

**Definition 1** *If  $\Sigma = \delta(O, V)$  where  $O \subset \mathbb{Z}^3$  is  $n$ -connected and  $V$  is one of its background components. Let  $(a, b)$  and  $(a', b')$  be two surfels of  $\delta$ . We say that the two surfels  $(a, b)$  and  $(a', b')$  are  $e$ -adjacent if they share an edge and :*

- *If  $(n, \bar{n}) = (6, 18)$  then  $a$  and  $a'$  are 6-connected by a sequence of at most 3 voxels in  $O$ .*
- *If  $(n, \bar{n}) = (18, 6)$  then  $b$  and  $b'$  are 6-connected by a sequence of at most 3 voxels in  $\bar{O}$ .*

A pair  $\{x, y\}$  of  $e$ -adjacent surfels of  $\Sigma$  is called an *edgel*.

As in [ML98] we define a *loop* as an  $e$ -connected component of the set of the surfels which share a given vertex (see Figure 1). One can see that a vertex is not sufficient to uniquely define a loop since a vertex can define two distinct loops. In fact, a loop is well defined given a vertex and a surfel incident to this vertex. We say that two surfels are  $v$ -adjacent (short for “vertex adjacent”) if they belong to a common loop. We denote by  $N_n(x)$  for  $n \in \{e, v\}$  the  $n$ -neighborhood of the surfel  $x$ , i.e. the set composed of the surfels of  $\Sigma$  which are  $n$ -adjacent to  $x$ .

In the case when  $\Sigma = \delta(O, V)$  and  $O$  is 18-connected, we avoid some special configurations by the assumption that any loop of the surface is a topological disk. A formal way to express this assumption is to say that two  $v$ -adjacent surfels which are not  $e$ -adjacent cannot both belong to two distinct loops. An equivalent formulation can be stated as follows: we assume that if the object  $O$  the surface of which we consider is studied with 18-connectivity, and if there exists in  $O$  two 18-adjacent voxels which are not 6-adjacent (see Figure 2) then, at least one of the two following properties is satisfied:

- The two voxels have an 18-neighbor in  $O$  in common.
- The voxels have two 26-neighbors in  $O$  in common which are themselves 26-adjacent.

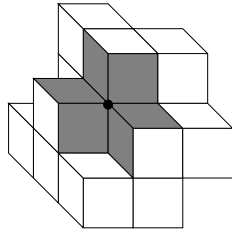

Fig. 1. Example of a loop.

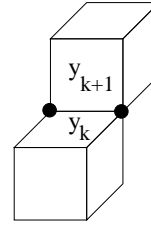

Fig. 2. A pathological case for which a loop is not a topological disk.

This restriction is necessary and sufficient to ensure that a loop is a topological disk. We need a similar restriction on  $\bar{O}$  when  $\Sigma = \delta_{6+}(O, V)$ .

In the sequel, we refer to the following remark :

**Remark 1** *Exactly one loop of  $\Sigma$  may contain two surfels which are  $v$ -adjacent but not  $e$ -adjacent.*

The purpose of this paper is to study the topological properties of subsets of the set of the surfels of  $\Sigma$ . Let  $X \subset \Sigma$ , let  $a$  and  $b$  two surfels of  $X$  and  $n \in \{e, v\}$ . We define an  $n$ -path  $c$  from  $a$  to  $b$  in  $X$  with a length  $k$  as a sequence  $(x_i)_{i=0, \dots, k}$  of surfels of  $X$  with  $x_0 = a$ ,  $x_k = b$  and such that for  $i \in \{0, \dots, k-1\}$ , the surfel  $x_i$  is  $n$ -adjacent to  $x_{i+1}$ . The  $n$ -path  $c$  is called *closed* if  $x_k$  is equal to  $x_0$ , and then subscripts of surfels in  $c$  must be understood modulo  $k$ . A path  $(x_i)_{i=0, \dots, k}$  is said *simple* if  $x_i \neq x_j$  when  $i \neq j$  (except for  $\{i, j\} = \{0, k\}$  if  $c$  is closed). For a surfel  $x$ , we will denote  $x \in c$  if  $x = x_i$  for some  $i \in \{0, \dots, k\}$ , we also denote by  $c^*$  the set  $\{x \mid x \in c\}$ . Two surfels  $x$  and  $x'$  are called  $n$ -connected in  $X$  if there exists an  $n$ -path from  $x$  to  $x'$  in  $X$ . This is an equivalence relation and the  $n$ -connected components of  $X$  are the equivalence classes of this relation. If  $X \subset \Sigma$ , we denote by  $\mathcal{C}_n(X)$  the set of  $n$ -connected components of  $X$  and by  $\mathcal{C}_n^x(X)$  the set of all  $n$ -connected components of  $X$  which are  $n$ -adjacent to a

given surfel  $x$ . Note that  $\mathcal{C}_n(X)$  is a set of subsets of  $\Sigma$  and not a set of surfels. If  $\alpha$  and  $\beta$  are two  $n$ -paths such that the last surfel of  $\alpha$  is  $n$ -adjacent or equal to the first surfel of  $\beta$ , we denote by  $\alpha * \beta$  the concatenation of the two paths  $\alpha$  and  $\beta$ . Note that in the case when the last surfel of  $\alpha$  is equal to the first surfel of  $\beta$  it is not duplicated in the resulting concatenation.

We also need to recall the notion of a digital simple closed curve.

**Definition 2** *A subset  $C$  of  $\Sigma$  is called a simple closed  $n$ -curve (for  $n \in \{e, v\}$ ) if it is  $n$ -connected and any surfel  $x$  of  $C$  is  $n$ -adjacent to exactly two other surfels of  $C$ . In this case, one can find a simple closed  $n$ -path  $c$  in  $\Sigma$  such that  $c^* = C$  which is called a parameterization of the curve  $C$ . We also call  $c$  a parameterized simple closed  $n$ -curve.*

#### 1.4 Simple surfels, Homotopy

Let  $x \in \Sigma$ . As previously set, we assume that any loop in  $\Sigma$  is a topological disk. However, the  $v$ -neighborhood of the surfel  $x$  is not always a topological disk. In such a case, we have to define a topology on  $N_v(x) \cup \{x\}$  under which it is a topological disk. Let us consider two surfels  $y$  and  $y'$  in  $N_v(x) \cup \{x\}$ . We say that  $y$  and  $y'$  are  $e_x$ -adjacent [respectively  $v_x$ -adjacent] if they are  $e$ -adjacent [respectively  $v$ -adjacent] and are contained in a common loop which contains  $x$ . We denote by  $G_e(x, X)$  [respectively  $G_v(x, X)$ ] the graph whose vertices are the surfels of  $N_v(x) \cap X$  and whose edges are pairs of  $e_x$ -adjacent [respectively  $v_x$ -adjacent] surfels of  $N_v(x) \cap X$ . We denote by  $\mathcal{C}_n^x(G_n(x, X))$  the set of all connected components of  $G_n(x, X)$  which contain a surfel  $n$ -adjacent to  $x$ .

**Definition 3** *We call  $x \in X$  an  $n$ -isolated surfel if  $N_n(x) \cap X = \emptyset$  and an  $n$ -interior surfel if  $N_{\bar{n}}(x) \cap \bar{X} = \emptyset$ .*

**Definition 4 (simple surfel [ML98])** *A surfel  $x$  is called  $n$ -simple in  $X$  if and only if the number  $\text{Card}(\mathcal{C}_n^x(G_n(x, X)))$  of connected components of  $G_n(x, X)$  which are  $n$ -adjacent to  $x$  is equal to 1, and if  $x$  is not  $n$ -interior to  $X$ . Intuitively, a surfel is  $n$ -simple in  $X$  if its deletion does not change the topology of  $X$ .*

**Remark 2** *Similarly with the 2D case, if the surfel  $x$  is neither  $n$ -isolated nor  $n$ -interior then we have  $\text{Card}(\mathcal{C}_n^x[G_n(x, X)]) = \text{Card}(\mathcal{C}_{\bar{n}}^x[G_{\bar{n}}(x, \bar{X})])$ .*

**Definition 5 (Homotopy)** *Let  $Y \subset X$  be two subsets of Sigma. The set  $Y$  is said to be (lower)  $n$ -homotopic to  $X$  if and only if  $Y$  can be obtained from  $X$  by sequential deletion of  $n$ -simple surfels.*

This notion of homotopy enables to define topology-preserving thinning algorithms within subsets of a digital surface.

#### 1.5 The fundamental group of a digital surface

In this section, we define the digital fundamental group in the framework of digital surfaces, following the definition of Kong in [Kon89] and [Kon88].

Now, we need to introduce the  $n$ -homotopy relation between  $n$ -paths. Intuitively, a path  $\alpha$  is homotopic to a path  $\beta$  if  $\alpha$  can be “continuously deformed” into  $\beta$ . Let us

consider  $X \subset \Sigma$ . First, we introduce the notion of an *elementary deformation*. Two closed  $n$ -paths  $\pi$  and  $\pi'$  in  $X$  having the same extremities are *the same up to an elementary  $n$ -deformation (with fixed extremities) in  $X$*  if they are of the form  $\pi = \pi_1 * \gamma * \pi_2$  and  $\pi' = \pi_1 * \gamma' * \pi_2$ , the  $n$ -paths  $\gamma$  and  $\gamma'$  having the same extremities and being both included in a common loop. Now, the two  $n$ -paths  $\pi$  and  $\pi'$  are said to be  *$n$ -homotopic (with fixed extremities) in  $X$*  if there exists a finite sequence of  $n$ -paths  $\pi = \pi_0, \dots, \pi_m = \pi'$  such that for  $i = 0, \dots, m-1$  the  $n$ -paths  $\pi_i$  and  $\pi_{i+1}$  are the same up to an elementary deformation (with fixed extremities). In this case, we denote  $\pi \simeq \pi'$ . A closed  $n$ -path  $\pi = (y_0, \dots, y_p = y_0)$  is said to be  *$n$ -reducible in  $X$*  if  $\pi \simeq_n (y_0, y_0)$  in  $X$ .

Let  $B \in X$  be a fixed surfel called the *base surfel*. We denote by  $A_B^n(X)$  the set of all closed  $n$ -paths  $\pi = (x_0, \dots, x_p)$  which are included in  $X$  and such that  $x_0 = x_p = B$ . The  $n$ -homotopy relation is an equivalence relation on  $A_B^n(X)$ , and we denote by  $\Pi_1^n(X, B)$  the set of the equivalence classes of this equivalence relation. If  $c \in A_B^n(X)$ , we denote by  $[c]_{\Pi_1^n(X, B)}$  the class of  $c$  under this relation.

The concatenation of closed  $n$ -paths is compatible with the  $n$ -homotopy relation, hence it defines an operation on  $\Pi_1^n(X, B)$ , which to the class of  $\alpha$  and the class of  $\beta$  associates the class of  $\alpha * \beta$ . This operation provides  $\Pi_1^n(X, B)$  with a group structure. We call this group the  *$n$ -fundamental group of  $X$* . The  $n$ -fundamental group defined using a surfel  $B'$  as base surfel is isomorphic to the  $n$ -fundamental group defined using a surfel  $B$  as base surfel if  $X$  is  $n$ -connected.

Now, we consider  $Y \subset X \subset \Sigma$  and  $B \in Y$  a base surfel. A closed  $n$ -path in  $Y$  is a particular case of a closed  $n$ -path in  $X$ . Furthermore, if two closed  $n$ -paths of  $Y$  are  $n$ -homotopic (with fixed extremities) in  $Y$ , they are  $n$ -homotopic (with fixed extremities) in  $X$ . These two properties enable us to define a canonical morphism  $i_* : \Pi_1^n(Y) \rightarrow \Pi_1^n(X)$ , which we call the morphism induced by the inclusion map  $i : Y \rightarrow X$ . To the class of a closed  $n$ -path  $\alpha \in A_B^n(Y)$  in  $\Pi_1^n(Y)$  the morphism  $i_*$  associates the class of the same  $n$ -path in  $\Pi_1^n(X)$ .

## 1.6 Euler characteristics

In the following, we will need to define precisely what we call a *topological disk* and a *topological sphere*. For this purpose, we will use the classical notion of Euler characteristics which has been defined for this framework in [ML98].

**Definition 6** *We associate a dimension to surfels, edgels and loops which is equal respectively to 2, 1 and 0. We can identify a surfel  $x$  with the set  $\{x\}$ . We call a surfel a 2-cell, an edgel a 1-cell and a loop a 0-cell.*

### Definition 7 (Elementary Euler $n$ -characteristics of a cell)

*For  $d \in \{0, 1, 2\}$  and for  $c$  a  $d$ -cell, we define the elementary Euler characteristics of  $c$  in  $X$  as*

$$\chi_n^d(X, c) = (-1)^d \cdot \text{Card}(\mathcal{C}_n(x \cap X)).$$

*Note that the only case in which  $\chi_n^d(X, c)$  can be different from 0, 1 and  $-1$  is when  $c$  is a loop and  $n = e$ . If  $\mathcal{E}_\Sigma$  and  $\mathcal{L}_\Sigma$  are respectively the sets of edgels and loops of  $\Sigma$ , we*



denote :

$$\chi_n^2(X) = \sum_{s \in \Sigma} \chi_n^2(X, s), \quad \chi_n^1(X) = \sum_{\epsilon \in \mathcal{E}_\Sigma} \chi_n^1(X, \epsilon) \quad \text{and} \quad \chi_n^0(X) = \sum_{l \in \mathcal{L}_\Sigma} \chi_n^0(X, l).$$

**Definition 8** We define the Euler  $n$ -characteristics of  $X$ , and we denote by  $\chi_n(X)$  the following quantity:

$$\chi_n(X) = \chi_n^0(X) + \chi_n^1(X) + \chi_n^2(X) = \text{Card}(X) + \chi_n^1(X) + \chi_n^2(X).$$

The following Theorem has been proved in [ML98] :

**Theorem 1** If  $Y \subset X \subset \Sigma$  are  $n$ -connected, then the following properties are equivalent:

- (1)  $Y$  is  $n$ -homotopic to  $X$ .
- (2)  $\chi_n(X) = \chi_n(Y)$  and each  $\bar{n}$ -connected component of  $\bar{Y}$  contains a surfel of  $\bar{X}$ .

## 2 Intersection Number of paths

In this section, we introduce a new tool for proving theorems in the framework of digital surfaces which has been introduced in [FM99]. The main idea of this tool is to count the number of *real intersections* between a  $v$ -path and an  $e$ -path. Again, we have to use two complementary adjacencies notably in order to avoid the classical topological paradox of paths which could cross without meeting themselves. Then, the main property of this number is that it is left unchanged when one apply an homotopic deformation to any of the two paths. Thus, it will be useful to distinguish homotopy classes of paths.

### 2.1 Definition

In order to define *oriented intersections*, we first define an orientation for surfels and then what we call the “left side” and the “right side” of an  $e$ -path.

**Notation 1 (Vertices and oriented edges)** Since a surfel has four vertices, we can order these vertices as in [RKW91] by distinguishing one vertex for each type of surfel (we distinguish 6 types of surfels according to their outward normal vector) and impose a turning order for vertices around the outward normal to the surfel (the counterclockwise order). Each vertex of a given surfel is associated with a number in  $\{0, 1, 2, 3\}$ . With this parameterization of vertices we can define *oriented edges* as couples of consecutive vertices according to the cyclic order. So, for each surfel, we have the four following oriented edges :  $(0, 1)$ ,  $(1, 2)$ ,  $(2, 3)$  and  $(3, 0)$ . For an  $e$ -path  $\pi = (y_k)_{k=0, \dots, p}$  and for  $k \in \{0, \dots, p\}$ , we define *front* $_\pi(k)$  when  $y_k \neq y_{k+1}$  (resp. *back* $_\pi(k)$  when  $y_k \neq y_{k-1}$ ) as the oriented edge  $(a, b)$  with  $a, b \in \{0, 1, 2, 3\}$  of the surfel  $y_k$  shared as an edge by  $y_k$  and  $y_{k+1}$  (resp.  $y_k$  and  $y_{k-1}$ ). Remark that *back* $_\pi(0)$  and *front* $_\pi(p)$  are not defined if  $\pi$  is not closed.

We want to define locally, at each point  $y_k$  of an  $e$ -path  $\pi$ , the right side and the left side of  $\pi$  on the surface, taking into account the orientation of the surface (Definition 10 below). These local left and right sets will be in fact subsets of the  $v$ -neighborhood of the surfel  $y_k$

**Lemma 1** Let  $x$  be a surfel of  $\Sigma$ . Then,  $N_v(x)$  is a simple closed  $e_x$ -curve.

**Proof:** We prove that for any surfel  $y$  of  $N_v(x)$ , there are exactly two surfels  $z_1$  and  $z_2$  in  $N_v(x)$  such that  $y$  is  $e_x$ -adjacent to  $z_1$  and  $z_2$ .

Let  $y$  be a surfel of  $N_v(x)$ . First, we suppose that  $y$  and  $x$  are not  $e$ -adjacent. Then, from Remark 1, only one loop  $\mathcal{L}$  of  $\Sigma$  may contain both  $x$  and  $y$ . Let  $z_1$  and  $z_2$  be the only (from the very definition of a loop) two surfels of  $\mathcal{L}$  which are  $e$ -adjacent to  $y$ . It follows that  $z_1$  and  $z_2$  are the only two surfels  $e$ -adjacent to  $y$  which can belong to a loop which contains  $x$ . In other words,  $z_1$  and  $z_2$  are the only two surfels  $e_x$ -adjacent to  $y$ .

Now, we may suppose that  $x$  and  $y$  are  $e$ -adjacent. Then, we may suppose without loss of generality that  $y$  shares as an edge with  $x$  the oriented edge  $(0, 1)$  of  $y$ . Then, exactly two loops contain both  $x$  and  $y$  :  $\mathcal{L}_0(y)$  and  $\mathcal{L}_1(y)$ . Let  $z_1$  be the (unique) surfel of  $\Sigma$  which shares as an edge with  $y$  the oriented edge  $(3, 0)$  of  $y$ ; and let  $z_2$  be the (unique) surfel of  $\Sigma$  which shares as an edge with  $y$  the oriented edge  $(1, 2)$  of  $y$ . It is immediate that  $\{z_1, z_2\} \subset N_v(x)$  and  $z_1 \neq z_2$ . Obviously the surfel  $z_3$  which share as an edge with  $y$  the oriented edge  $(2, 3)$  can belong neither to  $\mathcal{L}_1$  nor to  $\mathcal{L}_2$ . Finally,  $z_1$  and  $z_2$  are the only two surfels of  $\Sigma$  which are  $e_x$ -adjacent to  $y$ .

Furthermore, we must state that  $N_v(x)$  is  $e_x$ -connected. This comes immediately from the fact that  $N_v(x)$  is made of the union of the four loops which contain  $x$ , minus the surfel  $x$  itself. Now, the loops can be ordered following the vertices order; each one is  $e$ -connected and shares a surfel with its successor in the latter order. It follows that the union (minus  $\{x\}$ ) introduced before is  $e_x$ -connected.  $\square$

Now, given a surfel  $y$  in  $N_v(x)$ , there exists exactly two parameterizations (see Definition 2)  $\pi = (y_k)_{k=0, \dots, p}$  and  $\pi' = (y'_k)_{k=0, \dots, p'}$  of the simple closed  $e_x$ -curve  $\mathcal{C} = N_v(x)$  such that  $y_0 = y'_0$ . Furthermore, it is immediate that  $\pi^{-1} = \pi'$ . Then, we can define as follows a canonical parameterization of the neighborhood of a surfel  $x$  which starts at a given surfel  $y$  of  $N_v(x)$ .

**Definition 9 (canonical parameterization of  $N_v(x)$ )** *Let  $x \in \Sigma$  and  $y \in N_v(x)$ . We define the canonical parameterization of  $N_v(x)$  associated to the surfel  $y$ , denoted by  $\mathcal{C}_y(x)$ , as the only  $e_x$ -path  $\pi = (y_0, \dots, y_p)$  from  $y = y_0$  to  $y = y_p$  such that  $\pi$  is a parameterization of the simple closed  $e_x$ -curve  $\mathcal{C} = N_v(x)$  and which satisfies the following property : for all  $k \in \{0, \dots, p-1\}$ ,  $x \in \mathcal{L}_{w_k}(y_k)$  where  $(w_k - 1 \bmod 4, w_k)$  is the oriented edge of  $y_k$  shared as an edge by  $y_k$  and  $y_{k+1}$ .*

In other words,  $\mathcal{C}_y(x)$  is the only  $e_x$ -path  $\pi$  from  $y$  to  $y$  in  $N_v(x)$  such that  $x$  is always on the left of  $\pi$  for an observer which would walk on  $\pi$  and always look in the direction of the next surfel in the parameterization.

We can now define locally, at each point  $y_k$  of an  $n$ -path  $\pi$ , the locals left and right sides of  $\pi$  on the surface, taking into account the orientation of the surface.

**Notation 2** For a surfel  $x$  and a given vertex number  $w \in \{0, 1, 2, 3\}$  we denote by  $\mathcal{L}_w(x)$  the unique loop associated with the vertex number  $w$  of  $x$  which contains the surfel  $x$ .

**Definition 10 (local left and right sets)** *Let  $\pi = (y_k)_{k=0, \dots, p}$  be an  $n$ -path for  $n \in \{e, v\}$  and  $k \in \{1, \dots, p-1\}$  ( $k \in \{0, \dots, p\}$  if  $\pi$  is closed). Then, let  $\gamma = (\gamma_0, \dots, \gamma_l) = \mathcal{C}_{y_{k-1}}(y_k)$  be the canonical parameterization of  $N_v(y_k)$  associated to  $y_{k-1}$ . Let  $h$  be the*

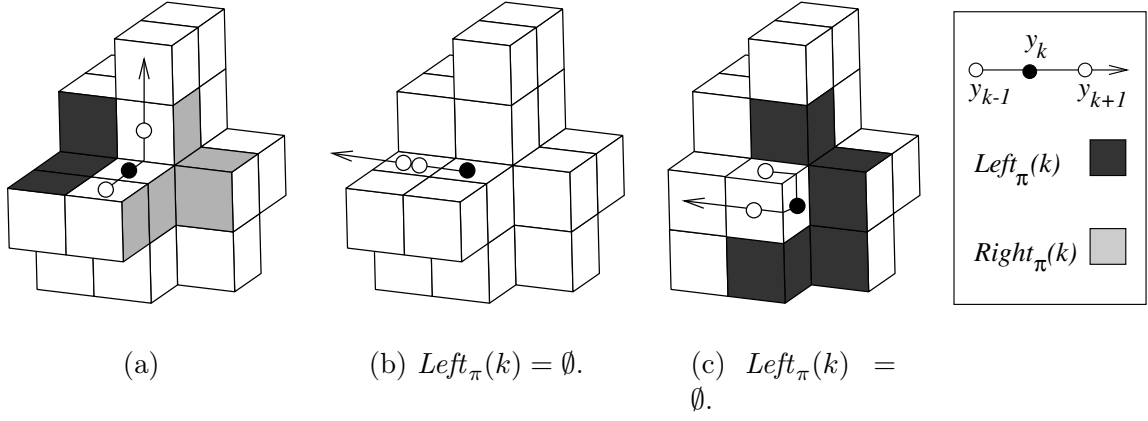

Fig. 3. Some illustrations of the sets  $Left_\pi(k)$  and  $Right_\pi(k)$  where  $\pi = (y_k)_{k=0, \dots, p}$ .

only integer in  $\{1, \dots, l\}$  such that  $y_{k+1} = \gamma_h$ . We define the sets of surfels  $Left_\pi(k)$  and  $Right_\pi(k)$  by :

If  $l = h$  (i.e  $y_{k-1} = y_{k+1}$ ) then  $Left_\pi(k) = Right_\pi(k) = \emptyset$ , otherwise,

$$Right_\pi(k) = N_v(y_k) \cap \{\gamma_i \mid 0 < i < h - 1\}$$

$$Left_\pi(k) = N_v(y_k) \cap \{\gamma_i \mid h + 1 < i < l\}$$

Note that both sets  $Right_\pi(0)$  and  $Left_\pi(0)$  are not defined in the case when  $\pi$  is not closed (since the notation  $y_{i-1}$  has no meaning for  $i = 0$  in this case).

A few examples of such sets  $Left_\pi(k)$  and  $Right_\pi(k)$  are depicted in Figure 3 for some  $e$ -paths.

**Remark 3** If  $c = (x_i)_{i=0, \dots, q}$  is an  $n$ -path [resp. a closed  $n$ -path] and  $i \in \{1, \dots, q - 1\}$  [resp.  $i \in \{0, \dots, q\}$ ] is such that  $x_{i+1}$  and  $x_{i-1}$  are  $e$ -adjacent, then either  $Right_c(i) = \emptyset$  and  $Left_c(i) = N_v(x_i) \setminus \{x_{i-1}, x_{i+1}\}$ ; or  $Left_c(i) = \emptyset$  and  $Right_c(i) = N_v(x_i) \setminus \{x_{i-1}, x_{i+1}\}$ . See Figure 3(c) for an example of such a situation. Conversely, one of these two sets may be empty only when the two surfels  $x_{i-1}$  and  $x_{i+1}$  are either equal or  $e$ -adjacent.

**Remark 4** If  $c = (x_i)_{i=0, \dots, q}$  is an  $n$ -path on  $\Sigma$ , then  $Left_c(i) \cap Right_c(i) = \emptyset$  for all  $i \in \{1, \dots, q - 1\}$  (for all  $i \in \{0, \dots, q - 1\}$  if  $c$  is closed).

**Remark 5** If  $c = (x_i)_{i=0, \dots, q}$  is an  $n$ -path on  $\Sigma$  and  $x_i$  is a surfel of  $c$  such that  $x_{i-1}$  and  $x_{i+1}$  are neither equal nor  $n_{x_i}$ -adjacent; then the sets  $Left_c(i)$  and  $Right_c(i)$  are both non empty and each contains a surfel which is  $\bar{n}$ -adjacent to  $x_i$ .

An example of a configuration which satisfies the latter remark is depicted in Figure 3(a). Indeed, the two surfels  $y_{k-1}$  and  $y_{k+1}$  of Figure 3(a) are not  $e_x$ -adjacent so that  $Left_\pi(k) \cap N_v(x) \neq \emptyset$  and  $Right_\pi(k) \cap N_v(x) \neq \emptyset$ . Finally, a counter example is depicted in Figure 3(c).

The following property is the necessary and sufficient condition which will allow the definition of the *intersection number* between two paths.

**Notation 3** Let  $\pi = (y_k)_{k=0,\dots,p}$  be an  $n$ -path and  $c = (x_i)_{i=0,\dots,q}$  be an  $\bar{n}$ -path in  $\Sigma$ . We say that the property  $\mathcal{P}(\pi, c)$  is satisfied if in case when  $\pi$  is not closed then neither  $y_0$  nor  $y_p$  belongs to  $c^*$ .

Now we define the contribution to the intersection number of a couple of subscripts.

**Definition 11 (contribution to the intersection number)** Let  $\pi = (y_k)_{k=0,\dots,p}$  be an  $n$ -path and  $c = (x_i)_{i=0,\dots,q}$  be an  $\bar{n}$ -path such that  $\mathcal{P}(\pi, c)$  holds. Let  $k \in \{0, \dots, p-1\}$  and  $i \in \{0, \dots, q\}$ . We define the contribution to the intersection number of the couple  $(k, i)$  denoted by  $\mathcal{I}_{\pi,c}(k, i)$  which is equal to zero if  $x_i \neq y_k$ , otherwise  $\mathcal{I}_{\pi,c}(k, i) = \mathcal{I}_{\pi,c}^-(k, i) + \mathcal{I}_{\pi,c}^+(k, i)$  where :

$$\begin{array}{l|l} \mathcal{I}_{\pi,c}^-(k, i) = 0 \text{ if } i = 0, & \mathcal{I}_{\pi,c}^+(k, i) = 0 \text{ if } i = q, \\ \mathcal{I}_{\pi,c}^-(k, i) = 0.5 \text{ if } x_{i-1} \in \text{Right}_\pi(k), & \mathcal{I}_{\pi,c}^+(k, i) = -0.5 \text{ if } x_{i+1} \in \text{Right}_\pi(k), \\ \mathcal{I}_{\pi,c}^-(k, i) = -0.5 \text{ if } x_{i-1} \in \text{Left}_\pi(k), & \mathcal{I}_{\pi,c}^+(k, i) = 0.5 \text{ if } x_{i+1} \in \text{Left}_\pi(k), \\ \mathcal{I}_{\pi,c}^-(k, i) = 0 \text{ in all other cases.} & \mathcal{I}_{\pi,c}^+(k, i) = 0 \text{ in all other cases.} \end{array}$$

Note that  $\mathcal{I}_{\pi,c}(k, i) = 0$  if  $x_{i-1} = x_{i+1}$  or  $y_{k-1} = y_{k+1}$  (since  $\text{Left}_\pi(k) = \text{Right}_\pi(k) = \emptyset$  in this case).

Note that  $\mathcal{I}_{\pi,c}^-(k, i)$  depends on the position of  $x_{i-1}$  relative to the  $n$ -path  $\pi$  at the surfel  $y_k$ , and  $\mathcal{I}_{\pi,c}^+(k, i)$  depends on the position of  $x_{i+1}$ . Also observe that  $\mathcal{I}_{\pi,c}(0, i) = 0$  for all  $i \in \{0, \dots, q\}$  if  $\pi$  is not closed since  $\mathcal{P}(\pi, c)$  implies that  $x_i \neq y_0$  for all  $i \in \{0, \dots, q\}$  in this case. Indeed, otherwise  $\mathcal{I}_{\pi,c}(0, i)$  would not be defined when  $\pi$  is not closed and  $x_i = y_0$ .

**Definition 12 (Intersection Number)** Let  $\pi = (y_k)_{k=0,\dots,p}$  be an  $n$ -path and let  $c = (x_i)_{i=0,\dots,q}$  be a  $\bar{n}$ -path such that the property  $\mathcal{P}(\pi, c)$  holds. The intersection number of the  $n$ -path  $\pi$  and the  $\bar{n}$ -path  $c$ , denoted by  $\mathcal{I}_{\pi,c}$ , is defined by :

$$\mathcal{I}_{\pi,c} = \sum_{k=0}^{p-1} \sum_{i=0}^q \mathcal{I}_{\pi,c}(k, i) = \sum_{k=0}^{p-1} \sum_{i|x_i=y_k} \mathcal{I}_{\pi,c}(k, i) = \sum_{i=0}^q \sum_{k|x_i=y_k} \mathcal{I}_{\pi,c}(k, i).$$

**Notation 4** Let  $\pi = (y_k)_{k=0,\dots,p}$  be an  $n$ -path and  $c = (x_i)_{i=0,\dots,q}$  be an  $\bar{n}$ -path such that  $\mathcal{P}(\pi, c)$  holds, then, for  $h \in \{0, \dots, p\}$  and  $l \in \{0, \dots, q\}$  we denote :

$$\mathcal{I}_{\pi,c}^\pi(l) = \sum_{k=0}^{p-1} \mathcal{I}_{\pi,c}(k, l) \text{ and } \mathcal{I}_{\pi,c}^c(h) = \sum_{i=0}^q \mathcal{I}_{\pi,c}(h, i).$$

Figure 4 and Figure 5 show two examples of intersection numbers.

**Notation 5** We call a trivial path any closed path  $(x, x)$  reduced to a surfel  $x$  of  $\Sigma$ .

**Remark 6** From the very definition of  $\mathcal{I}_{\pi,c}$ , we have  $\mathcal{I}_{\pi,c} = 0$  as soon as  $\pi$  or  $c$  is a trivial path.

### 3 Main properties

In this section, we introduce the main theorem relative to the intersection number which was first stated in [FM99] and [FM] with a less comprehensive proof. Indeed, the proofs

Fig. 4. A  $v$ -path  $c$  (in grey) and an  $e$ -path  $\pi$  (in black) such that  $\mathcal{I}_{\pi,c} = 0$ .

Fig. 5. A  $v$ -path  $c$  and an  $e$ -path  $\pi$  such that  $\mathcal{I}_{\pi,c} = \pm 1$ .

which will be given here are more concise than the ones in previously mentioned papers.

**Theorem 2** *Let  $\pi = (y_k)_{k=0,\dots,p}$  be an  $n$ -path in  $\Sigma$  ( $n \in \{e, v\}$ ). Furthermore, let  $c = (x_i)_{i=0,\dots,q}$  and  $c' = (x'_i)_{i=0,\dots,q'}$  be two  $\bar{n}$ -paths such that  $\mathcal{P}(\pi, c)$  and  $\mathcal{P}(\pi, c')$  hold. If  $c'$  is  $\bar{n}$ -homotopic to  $c$  in  $\Sigma$  (in  $\Sigma \setminus \{y_0, y_p\}$  if  $\pi$  is not closed), then  $\mathcal{I}_{\pi,c} = \mathcal{I}_{\pi,c'}$ .*

In other words, the intersection number between an  $n$ -path  $\pi$  and an  $\bar{n}$ -path  $c$ , as defined in previous subsection, is invariant under any homotopic deformation applied to the path  $c$ . First, we prove the following Proposition which states that the intersection number has a commutative property (up to a change of sign).

**Proposition 2** *Let  $\pi = (y_k)_{k=0,\dots,p}$  be an  $n$ -path of  $\Sigma$  and  $c = (x_i)_{i=0,\dots,q}$  be an  $\bar{n}$ -path of  $\Sigma$  such that both  $\mathcal{P}(\pi, c)$  and  $\mathcal{P}(c, \pi)$  hold. Then,  $\mathcal{I}_{\pi,c} = -\mathcal{I}_{c,\pi}$ .*

The Property stated by Theorem 2 can be used together with Proposition 2 to show that a closed  $n$ -path  $\alpha$  ( $n \in \{e, v\}$ ) is not  $n$ -homotopic to a trivial path by finding an  $\bar{n}$ -path  $\beta$  whose intersection number with  $\alpha$  is not equal to zero. More generally, it can be used to distinguish two not  $n$ -homotopic paths if their intersection numbers with a third  $\bar{n}$ -path are different.

Indeed, the following theorem is an immediate consequence of both Theorem 2 and Proposition 2.

**Theorem 3** *Let  $\pi = (y_k)_{k=0,\dots,p}$  and  $\pi' = (y'_k)_{k=0,\dots,p'}$  be two  $n$ -paths in  $\Sigma$  ( $n \in \{e, v\}$ ). Furthermore, let  $c = (x_i)_{i=0,\dots,q}$  be an  $\bar{n}$ -path such that the properties  $\mathcal{P}(\pi, c)$ ,  $\mathcal{P}(\pi', c)$ ,  $\mathcal{P}(c, \pi)$ , and  $\mathcal{P}(c, \pi')$  hold. If  $\pi'$  is  $n$ -homotopic to  $\pi$  in  $\Sigma$  (in  $\Sigma \setminus \{x_0, x_q\}$  if  $c$  is not closed), then  $\mathcal{I}_{\pi,c} = \mathcal{I}_{\pi',c}$ .*

**Proof:** From Proposition 2 and since  $\mathcal{P}(\pi, c)$  and  $\mathcal{P}(c, \pi)$  hold we have  $\mathcal{I}_{\pi,c} = -\mathcal{I}_{c,\pi}$ . On the other hand, still from Proposition 2 and since  $\mathcal{P}(\pi', c)$  and  $\mathcal{P}(c, \pi')$  hold we have  $\mathcal{I}_{\pi',c} = -\mathcal{I}_{c,\pi'}$ . Finally, from Theorem 2, since  $\mathcal{P}(c, \pi)$  and  $\mathcal{P}(c, \pi')$  hold; and since  $\pi'$  is  $n$ -homotopic to  $\pi$  in  $\Sigma$  (in  $\Sigma \setminus \{x_0, x_q\}$  if  $c$  is not closed) then  $\mathcal{I}_{c,\pi} = \mathcal{I}_{c,\pi'}$ .  $\square$

The proof of Theorem 2 will come after the following section which states several useful properties of the intersection number.

## 4 Useful Properties

### 4.1 Change of sign with path inversion

**Proposition 3** *Let  $\pi$  be an  $n$ -path and  $c$  be an  $\bar{n}$ -path such that  $\mathcal{P}(\pi, c)$  holds. Then  $\mathcal{I}_{\pi, c} = -\mathcal{I}_{\pi^{-1}, c}$ .*

In order to prove Proposition 3, we first state the following Lemmas.

**Lemma 4** *Let  $\pi = (y_k)_{k=0, \dots, p}$  be an  $n$ -path in  $\Sigma$ . Then,  $Left_{\pi}(k) = Right_{\pi^{-1}}(p-k)$  and  $Right_{\pi}(k) = Left_{\pi^{-1}}(p-k)$  for all  $k \in \{1, \dots, p-1\}$ . Furthermore, if  $\pi$  is closed, then  $Left_{\pi}(0) = Right_{\pi^{-1}}(0)$  and  $Right_{\pi}(0) = Left_{\pi^{-1}}(0)$ .*

**Proof:** Let  $\pi = (y_k)_{k=0, \dots, p}$  and  $\pi^{-1} = (y'_k)_{k=0, \dots, p}$ .

If  $\pi$  is closed, then  $y_0 = y'_0$ ,  $y_1 = y'_{p-1}$  and  $y_{p-1} = y'_1$ . Let  $\beta = \mathcal{C}_{y_{p-1}}(y_0) = (\beta^0, \dots, \beta^{l_0})$  be the canonical parameterization of  $N_v(y_0)$  associated to  $y_{p-1}$ . And let  $h_0$  be the only integer of  $\{1, \dots, l_0\}$  such that  $y_{p-1} = \beta^{h_0}$ . If  $h_0 = l_0$  it is immediate that  $Left_{\pi}(0) = Right_{\pi^{-1}}(0) = Right_{\pi}(0) = Left_{\pi^{-1}}(0) = \emptyset$ . If  $h_0 < l_0$  then it is also immediate that  $\beta' = (\beta^{h_0}, \beta^{h_0+1}, \dots, \beta^{l_0}) \cdot (\beta^0, \beta^1, \dots, \beta^{h_0})$  is the canonical parameterization of  $N_v(y'_0) = N_v(y_0)$  associated to the surfel  $y'_{p-1} = y_1$  (see Definition 9). Finally, from Definition 10,  $Left_{\pi}(0) = Right_{\pi^{-1}}(0)$  and  $Right_{\pi}(0) = Left_{\pi^{-1}}(0)$ .

Now, for all  $k \in \{1, \dots, p-1\}$  we observe that  $y_k = y'_{p-k}$ ,  $y_{k-1} = y'_{(p-k)+1}$  and  $y_{k+1} = y'_{(p-k)-1}$ . For such  $k$ , let  $\gamma = \mathcal{C}_{y_{k-1}}(y_k) = (\gamma^0, \dots, \gamma^l)$  be the canonical parameterization of  $N_v(y_k)$  associated to  $y_{k-1}$ . And let  $h$  be the only integer of  $\{1, \dots, l\}$  such that  $y_{k+1} = \gamma^h$ . If  $h = l$  it is immediate that  $Left_{\pi}(k) = Right_{\pi^{-1}}(p-k) = Right_{\pi}(k) = Left_{\pi^{-1}}(p-k) = \emptyset$ . If  $h < l$  then it is also immediate that  $\gamma' = (\gamma^h, \gamma^{h+1}, \dots, \gamma^l) \cdot (\gamma^0, \gamma^1, \dots, \gamma^h)$  is the canonical parameterization of  $N_v y'_{p-k} = N_v y_k$  associated to the surfel  $y'_{(p-k)-1} = y_{k+1}$  (see Definition 9). Finally, from Definition 10,  $Left_{\pi}(k) = Right_{\pi^{-1}}(p-k)$  and  $Right_{\pi}(k) = Left_{\pi^{-1}}(p-k)$ .  $\square$

**Lemma 5** *Let  $\pi = (y_k)_{k=0, \dots, p}$  be an  $n$ -path with a length  $p$  in  $\Sigma$  and  $c = (x_i)_{i=0, \dots, q}$  be an  $\bar{n}$ -path with a length  $q$  in  $\Sigma$  such that  $\mathcal{P}(\pi, c)$  holds. Then,  $\mathcal{I}_{\pi, c}(k, i) = -\mathcal{I}_{\pi^{-1}, c}(p-k, i)$  for all  $k \in \{1, \dots, p-1\}$  and all  $i \in \{0, \dots, q\}$ . If  $\pi$  is closed, then  $\mathcal{I}_{\pi, c}(0, i) = -\mathcal{I}_{\pi^{-1}, c}(0, i)$  for all  $i \in \{0, \dots, q\}$ .*

**Proof:** Let  $\pi^{-1} = (y'_0, \dots, y'_p)$ . From Lemma 5, we have  $Right_{\pi}(k) = Left_{\pi^{-1}}(p-k)$  and  $Left_{\pi}(k) = Right_{\pi^{-1}}(p-k)$  for all  $k \in \{1, \dots, p-1\}$ . Then, following Definition 11, we have  $\mathcal{I}_{\pi, c}(k, i) = -\mathcal{I}_{\pi^{-1}, c}(p-k, i)$  for all  $i \in \{0, \dots, q\}$ . If  $\pi$  is closed and still from Lemma 4 and Definition 11, we have  $Right_{\pi}(0) = Left_{\pi^{-1}}(0)$  and  $Left_{\pi}(0) = Right_{\pi^{-1}}(0)$  so that  $\mathcal{I}_{\pi, c}(0, i) = -\mathcal{I}_{\pi^{-1}, c}(0, i)$  for all  $i \in \{0, \dots, q\}$ .  $\square$

**Proof of Proposition 3:** Let  $\pi = (y_0, \dots, y_p)$ ,  $\pi^{-1} = (y'_0, \dots, y'_p)$  and  $c = (x_0, \dots, x_q)$ .

$$\mathcal{I}_{\pi,c} = \left[ \sum_{i=0}^q \mathcal{I}_{\pi,c}(0, i) \right] + \sum_{k=1}^{p-1} \sum_{i=0}^q \mathcal{I}_{\pi,c}(k, i) \quad (1)$$

$$\mathcal{I}_{\pi^{-1},c} = \left[ \sum_{i=0}^q \mathcal{I}_{\pi^{-1},c}(0, i) \right] + \sum_{k=1}^{p-1} \sum_{i=0}^q \mathcal{I}_{\pi^{-1},c}(p-k, i) \quad (2)$$

Following Lemma 5, we have  $\mathcal{I}_{\pi,c}(k, i) = -\mathcal{I}_{\pi^{-1},c}(p-k, i)$  for all  $k \in \{1, \dots, p-1\}$  and all  $i \in \{0, \dots, q\}$ . Furthermore, if  $\pi$  is not closed and since  $\mathcal{P}(\pi, c)$  holds, then  $\mathcal{I}_{\pi,c}(0, i) = \mathcal{I}_{\pi^{-1},c}(0, i) = 0$  for all  $i \in \{0, \dots, q\}$  (since  $x_i \neq y_0$  for such  $i$ ). If  $\pi$  is closed and still from Lemma 5, we have  $\mathcal{I}_{\pi,c}(0, i) = -\mathcal{I}_{\pi^{-1},c}(0, i)$  for all  $i \in \{0, \dots, q\}$ . Finally,  $\mathcal{I}_{\pi,c} = -\mathcal{I}_{\pi^{-1},c}$  from equations (1) and (2).  $\square$

**Proposition 6** *Let  $\pi = (y_k)_{k=0, \dots, p}$  be an  $n$ -path and  $c = (x_i)_{i=0, \dots, q}$  be an  $\bar{n}$ -path such that  $\mathcal{P}(\pi, c)$  holds; then  $\mathcal{I}_{\pi,c} = -\mathcal{I}_{\pi,c^{-1}}$ .*

In order to prove Proposition 6, we first establish the following Lemma.

**Lemma 7** *Let  $\pi = (y_k)_{k=0, \dots, p}$  be an  $n$ -path with a length  $p$  in  $\Sigma$  and  $c = (x_i)_{i=0, \dots, q}$  be an  $\bar{n}$ -path with a length  $q$  in  $\Sigma$  such that  $\mathcal{P}(\pi, c)$  holds. Then,  $\mathcal{I}_{\pi,c}(k, i) = -\mathcal{I}_{\pi,c^{-1}}(k, q-i)$  for all  $k \in \{0, \dots, p-1\}$  and all  $i \in \{0, \dots, q\}$ .*

**Proof:** Let  $c^{-1} = (x'_0, \dots, x'_q)$  so that for all  $i \in \{0, \dots, q\}$  we have  $x_i = x'_{q-i}$ .

- For  $i \in \{1, \dots, q-1\}$  we observe that  $x_i = x'_{q-i}$ ,  $x_{i-1} = x'_{(q-i)+1}$ ,  $x_{i+1} = x'_{(q-i)-1}$ . Thus from Definition 11 and for such  $i$ , we have  $\mathcal{I}_{\pi,c}(k, i) = -\mathcal{I}_{\pi,c^{-1}}(k, q-i)$  for all  $k \in \{0, \dots, p-1\}$ .

- For  $i = 0$ , since  $x_0 = x'_q$  and  $x_1 = x'_{q-1}$  we also have  $\mathcal{I}_{\pi,c}(k, 0) = \mathcal{I}_{\pi,c}^+(k, 0) = -\mathcal{I}_{\pi,c^{-1}}^-(k, q) = -\mathcal{I}_{\pi,c^{-1}}(k, q-0)$  for all  $k \in \{0, \dots, p-1\}$ .

- For  $i = q$ , since  $x_q = x'_0$  and  $x_{q-1} = x'_1$  we also have  $\mathcal{I}_{\pi,c}(k, q) = \mathcal{I}_{\pi,c}^-(k, q) = -\mathcal{I}_{\pi,c^{-1}}^+(k, 0) = -\mathcal{I}_{\pi,c^{-1}}(k, q-q)$  for all  $k \in \{0, \dots, p-1\}$ .

Finally, for all  $k \in \{0, \dots, p-1\}$  and all  $i \in \{1, \dots, q-1\}$  we have  $\mathcal{I}_{\pi,c}(k, i) = -\mathcal{I}_{\pi,c}(k, q-i)$ .  $\square$

**Proof of Proposition 6:** Let  $c^{-1} = (x'_0, \dots, x'_q)$  so that for all  $i \in \{0, \dots, q\}$  we have  $x_i = x'_{q-i}$ . Then,

$$\mathcal{I}_{\pi,c} = \sum_{k=0}^{p-1} \sum_{i=0}^q \mathcal{I}_{\pi,c}(k, i)$$

But, from Lemma 7,  $\mathcal{I}_{\pi,c}(k, i) = -\mathcal{I}_{\pi,c^{-1}}(k, q-i)$  for all  $i \in \{0, \dots, q\}$  and all  $k \in \{0, \dots, p-1\}$ . It is then immediate that,

$$\mathcal{I}_{\pi,c} = \sum_{k=0}^{p-1} \sum_{i=0}^q -\mathcal{I}_{\pi,c^{-1}}(k, i) = -\mathcal{I}_{\pi,c^{-1}}$$

$\square$

## 4.2 Commutativity property

In further proofs, we will use Proposition 2 which was introduced in subsection 3 and which states that swapping the roles played by the two paths in the definition of the intersection number leads to a change of the sign of this intersection number, when such a permutation is possible. Indeed, in the case when  $\pi$  is closed and  $c$  is not closed, then if an extremity of  $c$  belongs to  $\pi^*$  the intersection number  $\mathcal{I}_{\pi,c}$  is well defined whereas the number  $\mathcal{I}_{c,\pi}$  is not. The idea of this commutativity property is summarized in Figure 6 where one can say that  $c$  crosses  $\pi$  from left to right by observing one of the two following statements :

- $c$  enters  $\pi$  from the left side at the point  $a$  and exits  $\pi$  to the right side of  $\pi$  at the point  $b$ , or
- $\pi$  enters  $c$  from the right side of  $c$  at the point  $a$  and exits  $c$  to the left side of  $c$  at the point  $b$ .

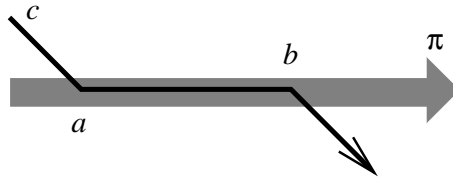

Fig. 6. There are two ways to check that  $c$  crosses  $\pi$  from left to right.

We recall Proposition 2 :

**Proposition 2** *Let  $\pi = (y_k)_{k=0,\dots,p}$  be an  $n$ -path of  $\Sigma$  and  $c = (x_i)_{i=0,\dots,q}$  be an  $\bar{n}$ -path of  $\Sigma$  such that both  $\mathcal{P}(\pi, c)$  and  $\mathcal{P}(c, \pi)$  hold. Then,  $\mathcal{I}_{\pi,c} = -\mathcal{I}_{c,\pi}$ .*

In order to prove this very intuitive result, we must state several technical lemmas.

**Lemma 8** *Let  $\pi = (y_k)_{k=0,\dots,p}$  be an  $n$ -path of  $\Sigma$  and  $c = (x_i)_{i=0,\dots,q}$  be an  $\bar{n}$ -path of  $\Sigma$  such that both  $\mathcal{P}(\pi, c)$  and  $\mathcal{P}(c, \pi)$  hold. For all  $k \in \{1, \dots, p-1\}$  ( $k \in \{0, \dots, p-1\}$  if  $\pi$  is closed) and all  $i \in \{1, \dots, q-1\}$ , we have  $\mathcal{I}_{\pi,c}(k, i) = -\mathcal{I}_{c,\pi}(i, k)$ .*

**Proof of Lemma 8:** Following Definition 11, the cases when  $x_i \neq y_k$ ,  $x_{i-1} = x_{i+1}$  or  $y_{k-1} = y_{k+1}$  are immediate since in these cases  $\mathcal{I}_{\pi,c}(k, i) = \mathcal{I}_{c,\pi}(i, k) = 0$ . Thus, we suppose in the sequel of this proof that  $x_i = y_k$ ,  $x_{i-1} \neq x_{i+1}$ ,  $y_{k-1} \neq y_{k+1}$ . By the same way, if  $x_{i-1} = y_{k-1}$  and  $x_{i+1} = y_{k+1}$ , or if  $x_{i-1} = y_{k+1}$  and  $x_{i+1} = y_{k-1}$  it is immediate that  $\mathcal{I}_{\pi,c}(k, i) = \mathcal{I}_{c,\pi}(i, k) = 0$ . Then we may also suppose that  $\{y_{k-1}, y_{k+1}\} \neq \{x_{i-1}, x_{i+1}\}$ ; the following cases remain :

**Case 1**  $x_{i-1} = y_{k-1}$  (see Figure 7) so that  $\mathcal{I}_{\pi,c}^-(k, i) = \mathcal{I}_{c,\pi}^-(i, k) = 0$ . Then, let  $\gamma = (\gamma^0, \dots, \gamma^l) = \mathcal{C}_{y_{k-1}}(y_k) = \mathcal{C}_{x_{i-1}}(x_i)$  be the canonical parameterization of  $N_v(y_k) = N_v(x_i)$  and  $h$  be the only integer in  $\{1, \dots, l\}$  such that  $y_{k+1} = \gamma^h$ . Following assumptions made before,  $x_{i+1} \notin \{\gamma^0 = \gamma^l, \gamma^h\}$ .

If  $x_{i+1} = \gamma^j$  for  $0 < j < h$  then  $x_{i+1} \in \text{Right}_\pi(k)$  and  $h > j$  implies that  $y_{k+1} \in \text{Left}_c(i)$  (see Definition 10). From Definition 11, it follows that  $\mathcal{I}_{\pi,c}^+(k, i) = -\mathcal{I}_{c,\pi}^+(i, k) = 0.5$  and finally  $\mathcal{I}_{\pi,c}(k, i) = -\mathcal{I}_{c,\pi}(i, k)$ .



If  $x_{i+1} = \gamma^j$  for  $h < j < l$  then  $x_{i+1} \in \text{Left}_\pi(k)$  and  $j > h$  implies that  $y_{k+1} \in \text{Right}_c(i)$  (see Definition 10). From Definition 11, it follows that  $\mathcal{I}_{\pi,c}^+(k, i) = 0.5$  and  $\mathcal{I}_{c,\pi}^+(i, k) = -0.5$  so that  $\mathcal{I}_{\pi,c}(k, i) = -\mathcal{I}_{c,\pi}(i, k)$ .

**Case 2**  $x_{i-1} = y_{k+1}$  (see Figure 7) so that  $\mathcal{I}_{\pi,c}^-(k, i) = \mathcal{I}_{c,\pi}^-(i, k) = 0$ . We observe that  $\mathcal{I}_{\pi,c}(k, i) = -\mathcal{I}_{\pi^{-1},c}(p-k, i)$  and  $\mathcal{I}_{c,\pi}(i, k) = -\mathcal{I}_{c,\pi^{-1}}(i, p-k)$  (Lemma 5). Thus, we must prove that  $\mathcal{I}_{\pi^{-1},c}(p-k, i) = \mathcal{I}_{c,\pi^{-1}}(i, p-k)$ . Now, let  $\pi^{-1} = (y'_0, \dots, y'_p)$  then  $y_k = y'_{p-k}$  and  $y_{k+1} = y'_{(p-k)-1}$  and we are came down to the previous case at subscript  $p-k$  of  $\pi^{-1}$ .

**Case 3**  $x_{i+1} = y_{k+1}$  (see Figure 7) so that  $\mathcal{I}_{\pi,c}^+(k, i) = \mathcal{I}_{c,\pi}^+(i, k) = 0$ . We observe that  $\mathcal{I}_{\pi,c}(k, i) = -\mathcal{I}_{\pi^{-1},c}(p-k, i) = \mathcal{I}_{\pi^{-1},c^{-1}}(p-k, q-i)$  (from Lemma 5 and Lemma 7), by the same way  $\mathcal{I}_{c,\pi}(i, k) = \mathcal{I}_{c^{-1},\pi^{-1}}(q-i, p-k)$ . It is then sufficient to prove that  $\mathcal{I}_{\pi^{-1},c^{-1}}(p-k, q-i) = -\mathcal{I}_{c^{-1},\pi^{-1}}(p-k, q-i)$ . If  $c^{-1} = (x'_0, \dots, x'_q)$  and  $\pi^{-1} = (y'_0, \dots, y'_q)$  then, on a first hand  $x_i = x'_{q-i}$ ,  $x_{i+1} = x'_{(q-i)-1}$ ,  $x_{i-1} = x'_{(q-i)+1}$ . On the other hand,  $y_k = y'_{p-k \bmod p}$ ,  $y_{k-1 \bmod p} = y'_{(p-k)+1 \bmod p}$  and  $y_{k+1 \bmod p} = y'_{(p-k)-1 \bmod p}$ . We are came back to case 1 with the subscripts  $(p-k \bmod p)$  and  $(q-i \bmod p)$  so that this case is equivalent to case 1.

**Case 4**  $x_{i+1} = y_{k-1}$  (see Figure 7) so that  $\mathcal{I}_{\pi,c}^+(k, i) = \mathcal{I}_{c,\pi}^+(i, k) = 0$ . We observe that  $\mathcal{I}_{\pi,c}(k, i) = -\mathcal{I}_{\pi,c^{-1}}(k, q-i)$  and  $\mathcal{I}_{\pi,c}(c, \pi) = -\mathcal{I}_{c^{-1},\pi}(q-i, k)$  (Lemma 7). It is then sufficient to prove that  $\mathcal{I}_{\pi,c^{-1}}(k, q-i) = \mathcal{I}_{c^{-1},\pi}(q-i, k)$ . If  $c^{-1} = (x'_0, \dots, x'_q)$  then  $x_i = x'_{q-i}$ ,  $x_{i-1} = x'_{(q-i)+1}$  and  $x_{i+1} = x'_{(q-i)-1}$  so that this cases is equivalent to case 1.

**Case 5** If  $\{x_{i+1}, x_{i-1}\} \cap \{y_{k-1}, y_{k+1}\} = \emptyset$ .

Let  $\gamma = (\gamma^0, \dots, \gamma^l) = \mathcal{C}_{y_{k-1}}(y_k)$  be the canonical parameterization of  $N_v(y_k)$  and  $h$  be the only integer in  $\{1, \dots, l\}$  such that  $y_{k+1} = \gamma^h$ . Then there exists  $m$  and  $m'$  such that  $\gamma^m = x_{i-1}$  and  $\gamma^{m'} = x_{i+1}$ . Since,  $\{x_{i+1}, x_{i-1}\} \cap \{\gamma^0 = \gamma^l, \gamma^h\} = \emptyset$  it follows that  $\{m, m'\} \subset \{1, \dots, h-1\} \cup \{h+1, \dots, l-1\}$ . The following cases are illustrated in Figure 8.

i) If  $1 < m < m' < h$  then

$$\gamma' = (\gamma^m, \dots, \gamma^{m'}) \cdot (\gamma^{m'}, \dots, \gamma^h) \cdot (\gamma^h, \dots, \gamma^l) \cdot (\gamma^0, \dots, \gamma^m)$$

is the canonical parameterization  $\mathcal{C}_{x_{i-1}}(x_i)$  of  $N_v(x_i)$ . It follows that  $\{x_{i-1}, x_{i+1}\} \subset \text{Right}_\pi(k)$  and  $\{\gamma^0 = y_{k-1}, \gamma^h = k_{k+1}\} \subset \text{Left}_c(i)$ . Finally, from Definition 11, we obtain that  $\mathcal{I}_{\pi,c}(k, i) = \mathcal{I}_{c,\pi}(i, k) = 0$ .

ii) If  $1 < m' < m < h$  then

$$\gamma' = (\gamma^m, \dots, \gamma^h) \cdot (\gamma^h, \dots, \gamma^l) \cdot (\gamma^0, \dots, \gamma^{m'}) \cdot (\gamma^{m'}, \dots, \gamma^m)$$

is the canonical parameterization  $\mathcal{C}_{x_{i-1}}(x_i)$  of  $N_v(x_i)$ . It follows that  $\{x_{i-1}, x_{i+1}\} \subset \text{Right}_\pi(k)$  and  $\{\gamma^l = y_{k-1}, \gamma^h = k_{k+1}\} \subset \text{Left}_c(i)$ . Finally, from Definition 11, we obtain that  $\mathcal{I}_{\pi,c}(k, i) = \mathcal{I}_{c,\pi}(i, k) = 0$ .

iii) If  $h < m < m' < l$  then

$$\gamma' = (\gamma^m, \dots, \gamma^{m'}) \cdot (\gamma^{m'}, \dots, \gamma^l) \cdot (\gamma^0, \dots, \gamma^h) \cdot (\gamma^h, \dots, \gamma^m)$$

is the canonical parameterization  $\mathcal{C}_{x_{i-1}}(x_i)$  of  $N_v(x_i)$ . It follows that  $\{x_{i-1}, x_{i+1}\} \subset$

$Left_\pi(k)$  and  $\{\gamma^0 = y_{k-1}, \gamma^h = k_{k+1}\} \subset Left_c(i)$ . Finally, from Definition 11, we obtain that  $\mathcal{I}_{\pi,c}(k, i) = -\mathcal{I}_{c,\pi}(i, k) = 0$ .

iv) If  $h < m' < m < l$  then

$$\gamma' = (\gamma^m, \dots, \gamma^l).(\gamma^0, \dots, \gamma^h).(\gamma^h, \dots, \gamma^{m'}).(\gamma^{m'}, \dots, \gamma^m)$$

is the canonical parameterization  $\mathcal{C}_{x_{i-1}}(x_i)$  of  $N_v(x_i)$ . It follows that  $\{x_{i-1}, x_{i+1}\} \subset Left_\pi(k)$  and  $\{\gamma^l = y_{k-1}, \gamma^h = k_{k+1}\} \subset Right_c(i)$ . Finally, from Definition 11, we obtain that  $\mathcal{I}_{\pi,c}(k, i) = -\mathcal{I}_{c,\pi}(i, k) = 0$ .

v) If  $0 < m < h < m' < l$  then

$$\gamma' = (\gamma^m, \dots, \gamma^h).(\gamma^h, \dots, \gamma^{m'}).(\gamma^{m'}, \dots, \gamma^l).(\gamma^0, \dots, \gamma^m)$$

is the canonical parameterization  $\mathcal{C}_{x_{i-1}}(x_i)$  of  $N_v(x_i)$ . It is then straightforward that  $x_{i-1} \in Right_\pi(k)$ ,  $x_{i+1} \in Left_\pi(k)$ ,  $y_{k-1} = \gamma^0 \in Left_c(i)$  and  $y_{k+1} = \gamma^h \in Right_c(i)$ . Finally, from Definition 11, we obtain that  $\mathcal{I}_{\pi,c}(k, i) = -\mathcal{I}_{c,\pi}(i, k) = +1$ .

vi) If  $0 < m' < h < m < l$  then

$$\gamma' = (\gamma^m, \dots, \gamma^l).(\gamma^0, \dots, \gamma^{m'}).(\gamma^{m'}, \dots, \gamma^h).(\gamma^h, \dots, \gamma^m)$$

is the canonical parameterization  $\mathcal{C}_{x_{i-1}}(x_i)$  of  $N_v(x_i)$ . It follows that  $x_{i-1} \in Left_\pi(k)$ ,  $x_{i+1} \in Right_\pi(k)$ ,  $y_{k-1} = \gamma^0 \in Right_c(i)$  and  $y_{k+1} = \gamma^h \in Left_c(i)$ . Finally, from Definition 11, we obtain that  $\mathcal{I}_{\pi,c}(k, i) = -\mathcal{I}_{c,\pi}(i, k) = -1$ .

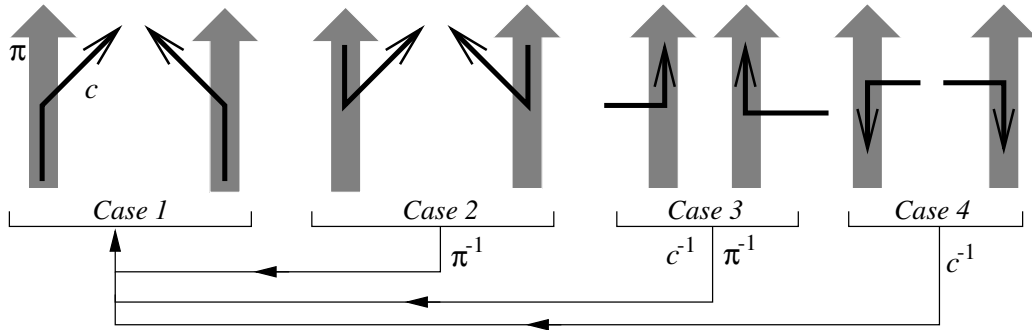

Fig. 7. An illustration of the cases investigated in the proof of Lemma 8 when  $\{x_{i-1}, x_{i+1}\} \cap \{y_{k-1}, y_{k+1}\} \neq \emptyset$

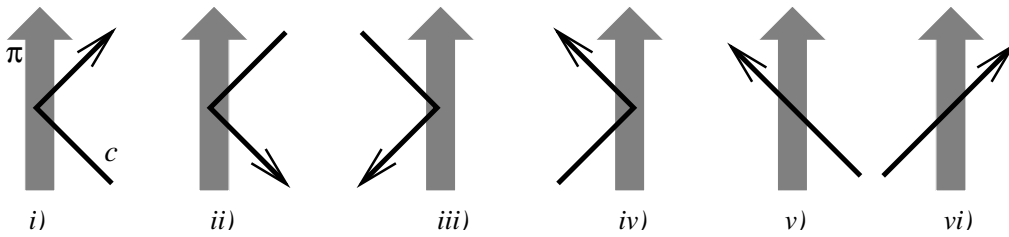

Fig. 8. An illustration of the cases investigated in the proof of Lemma 8 when  $\{x_{i-1}, x_{i+1}\} \cap \{y_{k-1}, y_{k+1}\} = \emptyset$

□

The following definition will allow us to use Lemma 8 for closed paths at subscripts corresponding to the extremities of either the path  $c$  or the path  $\pi$  of this lemma when the path is closed.

**Definition 13 (shift operation)** Let  $\pi = (y_k)_{k=0,\dots,p}$  be a closed  $n$ -path in  $\Sigma$  with a length  $p > 1$ . We denote by  $Sh(\pi)$  the closed  $n$ -path  $(y_{p-1}, y_0, \dots, y_{p-1})$  which is the result of a shift of  $\pi$  of one step in the opposite direction of its parameterization.

Then, the two following Lemmas will be of interest in the sequel.

**Lemma 9** Let  $\pi = (y_k)_{k=0,\dots,p}$  be a closed  $n$ -path and  $c = (x_i)_{i=0,\dots,q}$  be an  $\bar{n}$ -path in  $\Sigma$ . If  $\pi$  has a length  $p > 1$ , then  $\mathcal{I}_{\pi,c}(0, i) = \mathcal{I}_{Sh(\pi),c}(1, i)$  for all  $i \in \{0, \dots, q\}$ .

**Corollary 10** Let  $\pi = (y_k)_{k=0,\dots,p}$  be a closed  $n$ -path and  $c = (x_i)_{i=0,\dots,q}$  be an  $\bar{n}$ -path in  $\Sigma$ , then  $\mathcal{I}_{\pi,c} = \mathcal{I}_{Sh(\pi),c}$ .

**Proof of Lemma 9:** Let  $Sh(\pi) = (y'_0, \dots, y'_p)$  so that  $y_{p-1} = y'_0$ ,  $y_0 = y'_1$  and  $y_1 = y'_2$ . It follows that  $Right_\pi(0) = Right_{Sh(\pi)}(1)$  and  $Left_\pi(0) = Left_{Sh(\pi)}(1)$  so that  $\mathcal{I}_{\pi,c}(0, i) = \mathcal{I}_{Sh(\pi),c}(1, i)$  for all  $i \in \{0, \dots, q\}$ . □

**Lemma 11** Let  $\pi = (y_k)_{k=0,\dots,p}$  be an  $n$ -path and  $c = (x_i)_{i=0,\dots,q}$  be a closed  $\bar{n}$ -path in  $\Sigma$ . If  $c$  has a length  $q > 1$ , then  $\mathcal{I}_{\pi,Sh(c)}(k, 1) = \mathcal{I}_{\pi,c}(k, 0) + \mathcal{I}_{\pi,c}(k, q)$  for all  $k \in \{0, \dots, p\}$ .

**Corollary 12** Let  $\pi = (y_k)_{k=0,\dots,p}$  be an  $n$ -path and  $c = (x_i)_{i=0,\dots,q}$  be closed  $\bar{n}$ -path in  $\Sigma$ , then  $\mathcal{I}_{\pi,c} = \mathcal{I}_{\pi,Sh(c)}$ .

**Proof of Lemma 11:** Let  $Sh(c) = (x'_0, \dots, x'_q)$  so that  $x_{q-1} = x'_0$ ,  $x_0 = x'_1$  and  $x_1 = x'_2$ . We have  $\mathcal{I}_{\pi,Sh(c)}(k, 1) = \mathcal{I}_{\pi,Sh(c)}^-(k, 1) + \mathcal{I}_{\pi,Sh(c)}^+(k, 1)$ . Since  $x_0 = x'_1$  and  $x_{q-1} = x'_0$  it follows that  $\mathcal{I}_{\pi,Sh(c)}^-(k, 1) = \mathcal{I}_{\pi,c}^-(k, q)$  for all  $k \in \{0, \dots, p\}$ . Furthermore, since  $x_0 = x'_1$  and  $x_1 = x'_2$  it follows that  $\mathcal{I}_{\pi,Sh(c)}^+(k, 1) = \mathcal{I}_{\pi,c}^+(k, 0)$  for all  $k \in \{0, \dots, p\}$ .

Finally,  $\mathcal{I}_{\pi,Sh(c)}(k, 1) = \mathcal{I}_{\pi,c}^+(k, 0) + \mathcal{I}_{\pi,c}^-(k, q)$  for all  $k \in \{0, \dots, p\}$ ; but from Definition 11,  $\mathcal{I}_{\pi,c}^+(k, 0) = \mathcal{I}_{\pi,c}(k, 0)$  and  $\mathcal{I}_{\pi,c}^-(k, q) = \mathcal{I}_{\pi,c}(k, q)$ . □

Then, in order to prove Proposition 2 we will need the two following lemmas which state the behavior of the contributions to the intersection number at the extremities of each path  $\pi$  and  $c$  of the Proposition.

**Lemma 13** Let  $\pi = (y_k)_{k=0,\dots,p}$  be a closed  $n$ -path and  $c = (x_i)_{i=0,\dots,q}$  be an  $\bar{n}$ -path in  $\Sigma$ . Then  $\mathcal{I}_{\pi,c}(0, i) = -(\mathcal{I}_{c,\pi}(i, 0) + \mathcal{I}_{c,\pi}(i, p))$  for all  $i \in \{1, \dots, q-1\}$ .

**Proof:** From Lemma 9, we have  $\mathcal{I}_{\pi,c}(0, i) = \mathcal{I}_{Sh(\pi),c}(1, i)$ . From Lemma 8 and for all  $i \in \{1, \dots, q-1\}$ ,  $\mathcal{I}_{Sh(\pi),c}(1, i) = -\mathcal{I}_{c,Sh(\pi)}(i, 1)$ . Now, since  $\pi$  is closed and from Lemma 11,  $-\mathcal{I}_{c,Sh(\pi)}(i, 1) = -(\mathcal{I}_{c,\pi}(i, 0) + \mathcal{I}_{c,\pi}(i, p))$ . □

**Lemma 14** Let  $\pi = (y_k)_{k=0,\dots,p}$  be closed  $n$ -path and  $c = (x_i)_{i=0,\dots,q}$  be closed  $\bar{n}$ -path in  $\Sigma$ . Then  $\mathcal{I}_{\pi,c}(0, 0) + \mathcal{I}_{\pi,c}(0, q) = -(\mathcal{I}_{c,\pi}(0, 0) + \mathcal{I}_{c,\pi}(0, p))$

**Proof:** From Lemma 9,  $\mathcal{I}_{\pi,c}(0, 0) + \mathcal{I}_{\pi,c}(0, q) = \mathcal{I}_{Sh(\pi),c}(1, 0) + \mathcal{I}_{Sh(\pi),c}(1, q)$  and from Lemma 11,  $\mathcal{I}_{Sh(\pi),c}(1, 0) + \mathcal{I}_{Sh(\pi),c}(1, q) = \mathcal{I}_{Sh(\pi),Sh(c)}(1, 1)$ . Then, following Lemma 8,  $\mathcal{I}_{Sh(\pi),Sh(c)}(1, 1) = -\mathcal{I}_{Sh(c),Sh(\pi)}(1, 1)$ . Again, Lemma 9 implies that  $-\mathcal{I}_{Sh(c),Sh(\pi)}(1, 1) =$

$-\mathcal{I}_{c,Sh(\pi)}(0,1)$  whereas Lemma 11 implies that  $-\mathcal{I}_{c,Sh(\pi)}(0,1) = -(\mathcal{I}_{c,\pi}(0,0) + \mathcal{I}_{c,\pi}(0,p))$ . Finally, we have obtained that  $\mathcal{I}_{\pi,c}(0,0) + \mathcal{I}_{\pi,c}(0,q) = -(\mathcal{I}_{c,\pi}(0,0) + \mathcal{I}_{c,\pi}(0,p))$ .  $\square$

**Proof of Proposition 2:** The sum of Definition 12 may be written as follows :

$$\begin{aligned} \mathcal{I}_{\pi,c} = & \mathcal{I}_{\pi,c}(0,0) + \mathcal{I}_{\pi,c}(0,q) + \sum_{i=1}^{q-1} \mathcal{I}_{\pi,c}(0,i) + \\ & \sum_{k=1}^{p-1} \left[ \mathcal{I}_{\pi,c}(k,0) + \mathcal{I}_{\pi,c}(k,q) + \sum_{i=1}^{q-1} \mathcal{I}_{\pi,c}(k,i) \right] \end{aligned} \quad (3)$$

• If  $\pi$  is closed then Lemma 13 implies that  $\mathcal{I}_{\pi,c}(0,i) = -\mathcal{I}_{c,\pi}(i,0) - \mathcal{I}_{c,\pi}(i,p)$  for  $i \in \{1, \dots, q-1\}$ . Then,  $\sum_{i=1}^{q-1} \mathcal{I}_{\pi,c}(0,i) = -\sum_{i=1}^{q-1} [\mathcal{I}_{c,\pi}(i,0) + \mathcal{I}_{c,\pi}(i,p)]$ . Furthermore, from Lemma 8,  $\mathcal{I}_{\pi,c}(k,i) = -\mathcal{I}_{c,\pi}(i,k)$  for all  $k \in \{1, \dots, p-1\}$  and all  $i \in \{1, \dots, q-1\}$ . Thus, equation (3) becomes :

$$\begin{aligned} \mathcal{I}_{\pi,c} = & \mathcal{I}_{\pi,c}(0,0) + \mathcal{I}_{\pi,c}(0,q) + \sum_{i=1}^{q-1} -(\mathcal{I}_{c,\pi}(i,0) + \mathcal{I}_{c,\pi}(i,p)) + \\ & \sum_{k=1}^{p-1} \left[ \mathcal{I}_{\pi,c}(k,0) + \mathcal{I}_{\pi,c}(k,q) + \sum_{i=1}^{q-1} \mathcal{I}_{c,\pi}(i,k) \right] \end{aligned} \quad (4)$$

– If  $c$  is closed, then Lemma 13 implies that  $\mathcal{I}_{c,\pi}(0,k) = -(\mathcal{I}_{\pi,c}(k,0) + \mathcal{I}_{\pi,c}(k,q))$  for  $k \in \{1, \dots, p-1\}$  so that equation (4) becomes :

$$\begin{aligned} \mathcal{I}_{\pi,c} = & \mathcal{I}_{\pi,c}(0,0) + \mathcal{I}_{\pi,c}(0,q) - \sum_{i=1}^{q-1} [\mathcal{I}_{c,\pi}(i,0) + \mathcal{I}_{c,\pi}(i,p)] + \\ & \sum_{k=1}^{p-1} \left[ -\mathcal{I}_{c,\pi}(0,k) - \sum_{i=1}^{q-1} \mathcal{I}_{c,\pi}(i,k) \right] \end{aligned}$$

If  $\pi$  and  $c$  are closed paths, it follows from Lemma 14 that  $\mathcal{I}_{\pi,c}(0,0) + \mathcal{I}_{\pi,c}(0,q) = \mathcal{I}_{c,\pi}(0,0) + \mathcal{I}_{c,\pi}(0,p)$ . Then,

$$\begin{aligned} \mathcal{I}_{\pi,c} = & -(\mathcal{I}_{c,\pi}(0,0) + \mathcal{I}_{c,\pi}(0,p)) - \sum_{i=1}^{q-1} [\mathcal{I}_{c,\pi}(i,0) + \mathcal{I}_{c,\pi}(i,p)] + \\ & \sum_{k=1}^{p-1} \left[ -\mathcal{I}_{c,\pi}(0,k) - \sum_{i=1}^{q-1} \mathcal{I}_{c,\pi}(i,k) \right] \end{aligned}$$

or,

$$\mathcal{I}_{\pi,c} = -\sum_{i=0}^{q-1} [\mathcal{I}_{c,\pi}(i,0) + \mathcal{I}_{c,\pi}(i,p)] - \sum_{k=1}^{p-1} \sum_{i=0}^{q-1} \mathcal{I}_{c,\pi}(i,k)$$

so,

$$\mathcal{I}_{\pi,c} = - \sum_{i=0}^{q-1} \mathcal{I}_{c,\pi}(i, 0) - \sum_{i=0}^{q-1} \mathcal{I}_{c,\pi}(i, p) - \sum_{k=1}^{p-1} \sum_{i=0}^{q-1} \mathcal{I}_{c,\pi}(i, k)$$

and finally,

$$\mathcal{I}_{\pi,c} = - \sum_{k=0}^p \sum_{i=0}^{q-1} \mathcal{I}_{c,\pi}(i, k) = -\mathcal{I}_{c,\pi}$$

- If  $c$  is not closed and since  $\mathcal{P}(c, \pi)$  holds, then  $\mathcal{I}_{c,\pi}(0, k) = \mathcal{I}_{\pi,c}(k, 0) = \mathcal{I}_{\pi,c}(k, q) = 0$  for all  $k \in \{0, \dots, p\}$ . Then, equation (4) becomes :

$$\begin{aligned} \mathcal{I}_{\pi,c} &= \sum_{i=1}^{q-1} -(\mathcal{I}_{c,\pi}(i, 0) + \mathcal{I}_{c,\pi}(i, p)) - \sum_{k=1}^{p-1} \sum_{i=1}^{q-1} \mathcal{I}_{c,\pi}(i, k) \quad \text{or,} \\ \mathcal{I}_{\pi,c} &= - \sum_{i=1}^{q-1} \mathcal{I}_{c,\pi}(i, 0) - \sum_{i=1}^{q-1} \mathcal{I}_{c,\pi}(i, p) - \sum_{k=1}^{p-1} \sum_{i=1}^{q-1} \mathcal{I}_{c,\pi}(i, k) \quad \text{finally,} \\ \mathcal{I}_{\pi,c} &= - \sum_{k=0}^p \sum_{i=1}^{q-1} \mathcal{I}_{c,\pi}(i, k) = - \sum_{i=1}^{q-1} \sum_{k=0}^p \mathcal{I}_{c,\pi}(i, k) \end{aligned}$$

Since  $\mathcal{I}_{c,\pi}(0, k) = 0$  for all  $k \in \{0, \dots, p\}$ ,

$$\mathcal{I}_{\pi,c} = - \sum_{i=0}^{q-1} \sum_{k=0}^p \mathcal{I}_{c,\pi}(i, k) = -\mathcal{I}_{c,\pi}$$

- If  $\pi$  is not closed and since  $\mathcal{P}(\pi, c)$  holds, then  $\mathcal{I}_{\pi,c}(0, i) = \mathcal{I}_{\pi,c}(p, i) = \mathcal{I}_{c,\pi}(i, 0) = \mathcal{I}_{c,\pi}(i, p) = 0$  for  $i \in \{0, \dots, q\}$  so that  $\sum_{i=0}^q \mathcal{I}_{\pi,c}(0, i) = 0$ . Then, equation (3) becomes :

$$\mathcal{I}_{\pi,c} = \sum_{k=1}^{p-1} \left[ \mathcal{I}_{\pi,c}(k, 0) + \mathcal{I}_{\pi,c}(k, q) + \sum_{i=1}^{q-1} \mathcal{I}_{\pi,c}(k, i) \right]$$

From Lemma 8,  $\mathcal{I}_{\pi,c}(k, i) = -\mathcal{I}_{c,\pi}(i, k)$  for all  $k \in \{1, \dots, p-1\}$  and all  $i \in \{1, \dots, q-1\}$ .

$$\mathcal{I}_{\pi,c} = \sum_{k=1}^{p-1} \left[ \mathcal{I}_{\pi,c}(k, 0) + \mathcal{I}_{\pi,c}(k, q) - \sum_{i=1}^{q-1} \mathcal{I}_{c,\pi}(i, k) \right] \quad (5)$$

- If  $c$  is closed, then Lemma 13 implies that  $\mathcal{I}_{\pi,c}(k, 0) + \mathcal{I}_{\pi,c}(k, q) = -\mathcal{I}_{c,\pi}(0, k)$  for all  $k \in \{1, \dots, p-1\}$  and equation (5) becomes :

$$\mathcal{I}_{\pi,c} = \sum_{k=1}^{p-1} \sum_{i=0}^{q-1} -\mathcal{I}_{c,\pi}(i, k) = \sum_{i=0}^{q-1} \sum_{k=1}^{p-1} -\mathcal{I}_{c,\pi}(i, k)$$

Furthermore,  $\mathcal{I}_{c,\pi}(i, 0) = \mathcal{I}_{c,\pi}(i, p) = 0$  for all  $i \in \{0, \dots, q\}$  since  $\pi$  is not closed and  $\mathcal{P}(\pi, c)$  holds, so that :

$$\mathcal{I}_{\pi,c} = \sum_{i=0}^{q-1} \sum_{k=0}^p -\mathcal{I}_{c,\pi}(i, k) = -\mathcal{I}_{c,\pi}$$

– If  $c$  is not closed then  $\mathcal{I}_{\pi,c}(k, 0) = \mathcal{I}_{\pi,c}(k, q) = 0$  for all  $k \in \{0, \dots, p\}$  since  $\mathcal{P}(c, \pi)$  holds, then equation (5) becomes :

$$\mathcal{I}_{\pi,c} = - \sum_{k=1}^{p-1} \sum_{i=1}^{q-1} \mathcal{I}_{c,\pi}(i, k)$$

From Lemma 8,  $\mathcal{I}_{\pi,c}(k, i) = -\mathcal{I}_{c,\pi}(i, k)$  for all  $k \in \{1, \dots, p-1\}$  and all  $i \in \{1, \dots, q-1\}$ . Then,

$$\mathcal{I}_{\pi,c} = - \sum_{i=1}^{q-1} \sum_{k=1}^{p-1} \mathcal{I}_{c,\pi}(i, k) = -\mathcal{I}_{c,\pi}$$

□

### 4.3 An additive property

The following proposition will be useful in further proofs.

**Proposition 15** *Let  $\pi = (y_k)_{k=0, \dots, p}$  be an  $n$ -path on  $\Sigma$ ; let  $c = (x_i)_{i=0, \dots, q}$  and  $c' = (x'_i)_{i=0, \dots, q'}$  be two  $\bar{n}$ -paths on  $\Sigma$  such that  $x_q = x'_0$ . If  $\mathcal{P}(\pi, c)$  and  $\mathcal{P}(\pi, c')$  hold, then  $\mathcal{I}_{\pi, c.c'} = \mathcal{I}_{\pi, c} + \mathcal{I}_{\pi, c'}$ .*

**Proof of Proposition 15:** Let us compute  $\mathcal{I}_{\pi, c.c'}$  with  $c.c' = (z_0, \dots, z_{q+q'})$ .

It is sufficient to prove that for  $k \in \{1, \dots, p-1\}$  ( $k \in \{0, \dots, p\}$  if  $\pi$  is closed) :

$$\sum_{i=0}^{q+q'} \mathcal{I}_{\pi, c.c'}(k, i) = \sum_{i=0}^q \mathcal{I}_{\pi, c}(k, i) + \sum_{i=0}^{q'} \mathcal{I}_{\pi, c'}(k, i) \quad (6)$$

We simply write that for  $k \in \{0, \dots, p-1\}$  ( $k \in \{0, \dots, p\}$  if  $\pi$  is closed) :

$$\begin{aligned} \sum_{i=0}^{q+q'} \mathcal{I}_{\pi, c.c'}(k, i) &= \mathcal{I}_{\pi, c.c'}(k, 0) + \left[ \sum_{i=1}^{q-1} \mathcal{I}_{\pi, c.c'}(k, i) \right] + \mathcal{I}_{\pi, c.c'}(k, q) \\ &\quad + \left[ \sum_{i=q+1}^{q+q'-1} \mathcal{I}_{\pi, c.c'}(k, i) \right] + \mathcal{I}_{\pi, c.c'}(k, q+q') \end{aligned} \quad (7)$$

Now, for such  $k$  we observe that  $\mathcal{I}_{\pi, c}(k, 0) = \mathcal{I}_{\pi, c}^+(k, 0)$  from Definition 11. Since  $x_0 = z_0$  and  $x_1 = z_1$  we obtain that  $\mathcal{I}_{\pi, c}^+(k, 0) = \mathcal{I}_{\pi, c.c'}^+(k, 0)$  which is also equal to  $\mathcal{I}_{\pi, c.c'}(k, 0)$  following Definition 11. By the same way, we prove that  $\mathcal{I}_{\pi, c.c'}(k, q+q') = \mathcal{I}_{\pi, c'}(k, q')$ .

For  $i \in \{1, \dots, q-1\}$ , we have  $\mathcal{I}_{\pi,c,c'}(k, i) = \mathcal{I}_{\pi,c}(k, i)$  since  $x_i = z_i$ ,  $x_{i-1} = z_{i-1}$  and  $x_{i+1} = z_{i+1}$ . Similarly, for  $i \in \{q+1, \dots, q+q'-1\}$ , we have  $\mathcal{I}_{\pi,c,c'}(k, i) = \mathcal{I}_{\pi,c'}(k, i-q)$  since  $x_i = z_{i-q}$ ,  $x_{i-1} = z_{(i-q)-1}$  and  $x_{i+1} = z_{(i-q)+1}$ .

Furthermore, we have  $\mathcal{I}_{\pi,c,c'}(k, q) = \mathcal{I}_{\pi,c,c'}^-(k, q) + \mathcal{I}_{\pi,c,c'}^+(k, q)$ . Then, we observe that  $\mathcal{I}_{\pi,c}(k, q) = \mathcal{I}_{\pi,c}^-(k, q)$  and  $\mathcal{I}_{\pi,c'}(k, 0) = \mathcal{I}_{\pi,c'}^+(k, 0)$ . But,  $\mathcal{I}_{\pi,c}^-(k, q) = \mathcal{I}_{\pi,c,c'}^-(k, q)$  since  $x_q = z_q$  and  $x_{q-1} = z_{q-1}$ . Similarly,  $\mathcal{I}_{\pi,c'}^+(k, 0) = \mathcal{I}_{\pi,c,c'}^+(k, q)$  since  $x'_0 = z_q$  and  $x'_1 = z_{q+1}$ . Finally,  $\mathcal{I}_{\pi,c,c'}(k, q) = \mathcal{I}_{\pi,c}(k, q) + \mathcal{I}_{\pi,c'}(k, 0)$ .

By replacing the corresponding terms in equation (7) we obtain that :

$$\begin{aligned} \sum_{i=0}^{q+q'} \mathcal{I}_{\pi,c,c'}(k, i) &= \mathcal{I}_{\pi,c'}(k, 0) + \left[ \sum_{i=1}^{q-1} \mathcal{I}_{\pi,c}(k, i) \right] + \mathcal{I}_{\pi,c}(k, q) \\ &\quad + \mathcal{I}_{\pi,c'}(k, 0) + \left[ \sum_{i=1}^{q'-1} \mathcal{I}_{\pi,c'}(k, i) \right] + \mathcal{I}_{\pi,c'}(k, q') \end{aligned}$$

or,

$$\sum_{i=0}^{q+q'} \mathcal{I}_{\pi,c,c'}(k, i) = \sum_{i=0}^q \mathcal{I}_{\pi,c}(k, i) + \sum_{i=0}^{q'} \mathcal{I}_{\pi,c'}(k, i)$$

Finally,  $\mathcal{I}_{\pi,c,c'} = \mathcal{I}_{\pi,c} + \mathcal{I}_{\pi,c'}$ .  $\square$

**Corollary 16** *Let  $\pi = (y_k)_{k=0,\dots,p}$  and  $\pi' = (y'_k)_{k=0,\dots,p'}$  be two  $n$ -paths on a digital surface  $\Sigma$  such that  $y_p = y'_0$ ; let  $c = (x_i)_{i=0,\dots,q}$  be an  $\bar{n}$ -path on  $\Sigma$ . If  $\mathcal{P}(\pi, c)$ ,  $\mathcal{P}(\pi', c)$ ,  $\mathcal{P}(c, \pi)$  and  $\mathcal{P}(c, \pi')$  hold then  $\mathcal{I}_{\pi,\pi',c} = \mathcal{I}_{\pi,c} + \mathcal{I}_{\pi',c}$ .*

**Proof:** Since  $\mathcal{P}(c, \pi)$  and  $\mathcal{P}(c, \pi')$  hold it is immediate that  $\mathcal{P}(c, \pi.\pi')$  holds. Then, from Proposition 2, we have  $\mathcal{I}_{\pi,\pi',c} = \mathcal{I}_{c,\pi.\pi'}$ . Now, from Proposition 15 we obtain that  $\mathcal{I}_{c,\pi.\pi'} = \mathcal{I}_{c,\pi} + \mathcal{I}_{c,\pi'}$ . But, under the hypothesis of this corollary and again from Proposition 2 we have  $\mathcal{I}_{c,\pi} = \mathcal{I}_{\pi,c}$  and  $\mathcal{I}_{c,\pi'} = \mathcal{I}_{\pi',c}$ .  $\square$

## 5 Proof of the main Theorems

The proof of Theorem 2 will be slightly different for the case when  $(n, \bar{n}) = (e, v)$  and  $(n, \bar{n}) = (v, e)$ . However, in both cases, we will first define a relation of deformation between paths (the which is in fact equivalent to the homotopy relation as stated respectively by Proposition 24 and Proposition 17 respectively for  $n = v$  and  $n = e$ ).

For  $n = v$ , this new deformation is based on the insertion of triplets of surfels, or the insertion of back and forth in the paths. Then, Proposition 18 will state that a triplet of surfel always have an intersection number equal to zero with any  $e$ -path (as soon as this  $e$ -path is closed, otherwise the triplet must not meet an extremity of the  $e$ -path).

For  $n = e$ , this new deformation is based on the insertion of  $e$ -loops of surfels (Definition 17), or the insertion of back and forth in the paths. Then, Proposition 25 will state

in a similar way to Proposition 18 that an  $e$ -loop always have an intersection number equal to zero with any  $v$ -path (a soon as this  $v$ -path is closed, otherwise the  $e$ -loop must not meet an extremity of the  $v$ -path).

Finally, using Proposition 15, a straightforward proof of Theorem 2 for  $n = e$  and  $n = v$  will be given.

**Remark 7** *Note that, without loss of generality, we suppose in this section that any path mentioned (except closed ones) has the following property : two consecutive surfels in the path are distinct.*

### 5.1 Another definition for the homotopy of $v$ -paths

First, we introduce the notion of an elementary  $\mathcal{T}$ -deformation and the definition of the  $\mathcal{T}$ -deformation relation follows immediately.

**Definition 14 (back and forth)** *A simple closed  $n$ -path  $\pi = (x_0, x_1, x_0)$  in  $\Sigma$  is called a back and forth in  $\Sigma$ .*

**Definition 15 (triplet)** *A simple closed  $v$ -path  $\pi = (x_0, x_1, x_2, x_0)$  included in a loop of  $\Sigma$  is called a triplet in  $\Sigma$ .*

**Definition 16** *Let  $X \subset \Sigma$ ,  $c = (x_i)_{i=0, \dots, q}$  and  $c' = (x'_i)_{i=0, \dots, q'}$  be two  $v$ -paths in  $X$ . The path  $c$  is said to be an elementary  $\mathcal{T}$ -deformation of  $c'$  in  $X$  (and we denote  $c \sim_{\mathcal{T}} c'$ ) if  $c = \pi_1.(s).\pi_2$  and  $c' = \pi_1.\gamma.\pi_2$ ; or if  $c = \pi_1.\gamma.\pi_2$  and  $c' = \pi_1.(s).\pi_2$ . Where  $\gamma$  is a back and forth from  $s$  to  $s$  in  $X$ , or  $\gamma$  is a triplet from  $s$  to  $s$  in  $X$ . We define the  $\mathcal{T}$ -deformation relation as the transitive closure of the elementary  $\mathcal{T}$ -deformation relation.*

In other words, the relation of elementary  $\mathcal{T}$ -deformation links together two  $v$ -paths which are almost the same except that one is obtained by insertion in the other of a triplet of surfels which belongs to the same loop, or by insertion in the other of a *back and forth*. Now, we can state the following proposition :

**Proposition 17** *Let  $X \subset \Sigma$ . Two  $v$ -paths  $c$  and  $c'$  are  $v$ -homotopic in  $X$  if and only if they are the same up to a  $\mathcal{T}$ -deformation.*

**Proof:** First, an elementary  $\mathcal{T}$ -deformation is a particular case of an elementary  $v$ -deformation where the  $v$ -paths  $\gamma$  and  $\gamma'$ , used in subsection 1.5 to define an elementary  $n$ -deformation, are closed paths, one of which is reduced to a single surfel and the other one is a triplet or a closed path with a length of 2 which are both included in a loop, i.e. an elementary deformation cell. It immediately follows that if two  $v$ -paths are the same up to a  $\mathcal{T}$ -deformation then they are  $v$ -homotopic.

Now, it is sufficient to prove that, if two  $v$ -paths are the same up to an elementary  $v$ -deformation, then they are the same up to a  $\mathcal{T}$ -deformation. Let  $c$  and  $c'$  be two  $v$ -paths which are the same up to an elementary  $v$ -deformation, i.e.  $c = \pi_1.\gamma.\pi_2$  and  $c' = \pi_1.\gamma'.\pi_2$  where  $\gamma$  and  $\gamma'$  are two paths with the same extremities and included in a common loop.

We first prove that any  $v$ -path  $\alpha = (a_0, \dots, a_h)$  with a length  $l$  greater than one and included in a loop is a  $\mathcal{T}$ -deformation of the path  $(a_0, a_h)$ . We proceed by an induction



on the length  $l$ . Let  $\alpha_k$  be a  $v$ -path included in a loop  $\mathcal{L}$  with a length  $l_k$ . We distinguish two cases :

- Either  $\alpha_k = (a_0, a_1)$ , or
- $\alpha_k$  is a path with a length  $l_k \geq 2$ . Then  $\alpha_k = \omega.(a, b, c)$  where  $\{a, b, c\} \subset \mathcal{L}$  and  $\omega$  may be reduced to  $(a)$  if  $l = 2$ . Then the path  $\alpha_k$  is an elementary  $\mathcal{T}$ -deformation of the path  $\alpha' = \omega.(a, b, c).(c, b, a, c).(c)$ . Now,  $\alpha' = \omega.(a, b).(b, c, b).(b, a, c)$  is an elementary  $\mathcal{T}$ -deformation of the path  $\alpha'' = \omega.(a, b, a, c)$  which is itself an elementary  $\mathcal{T}$ -deformation of the path  $\alpha_{k+1} = \omega.(a, c)$ . Finally,  $\alpha_k$  is an  $\mathcal{T}$ -deformation of the path  $\alpha_{k+1} = \omega.(a, c)$ , which has a length  $l_{k+1} = l_k - 1$ .

Finally, either the path  $\alpha_k$  has a length of one or it is shown that  $\alpha_k$  is a  $\mathcal{T}$ -deformation of a path  $\alpha_{k+1}$  in  $X$  with a lower length than  $\alpha_k$ . By induction with  $\alpha_0 = \alpha$ , their must exist  $k' > 0$  such that  $\alpha_{k'}$  has a length of one (i.e  $\alpha_{k'} = (a_0, a_h)$ ) and which is a  $\mathcal{T}$ -deformation of  $\alpha$ .

Then, we have just proved that both paths  $\gamma$  and  $\gamma'$  are equivalent up to a  $\mathcal{T}$ -deformation in  $X$  to the path reduced to their extremities. It is then immediate that those two paths are themselves equivalent up to a  $\mathcal{T}$ -deformation in  $X$ .  $\square$

### 5.1.1 Intersection number of triplets

In this subsection, we will prove the following Proposition which states that a triplet  $c$  (Definition 15) has an intersection number equal to zero with any  $e$ -path  $\pi$  as soon as  $\mathcal{P}(\pi, c)$  holds.

**Proposition 18** *Let  $c$  be a triplet in  $\Sigma$  and let  $\pi = (y_k)_{k=0, \dots, p}$  be an  $e$ -path on  $\Sigma$  such that  $\mathcal{P}(\pi, c)$  holds. Then,  $\mathcal{I}_{\pi, c} = 0$ .*

In order to prove Proposition 18, we first state the two following lemmas.

**Lemma 19** *Let  $c = (x_0, x_1, x_2, x_0)$  be a triplet in  $\Sigma$ . Then, depending on the order of the parameterization of  $c$ , one of the two following properties is satisfied :*

- $\forall i \in \{0, 1, 2\}$ ,  $Left_c(i) \cap N_e(x_i) = \emptyset$ .
- $\forall i \in \{0, 1, 2\}$ ,  $Right_c(i) \cap N_e(x_i) = \emptyset$ .

**Proof:** This lemma comes from local considerations. Indeed, since for all  $i \in \{0, 1, 2\}$  the three surfels  $x_{i-1}$ ,  $x_i$  and  $x_{i+1}$  are included in a common loop, then, depending on the order of the parameterization, exactly one of the intervals between  $x_{i-1}$  and  $x_{i+1}$  of the canonical parameterization of  $N_v(x_i)$  cannot contain a surfel  $e$ -adjacent to  $x_i$ . And it is readily seen that this interval coincides either with  $Left_c(i)$  for all  $i \in \{0, 1, 2\}$  or with  $Right_c(i)$  for all  $i \in \{0, 1, 2\}$ .  $\square$

**Lemma 20** *Let  $c = (x_0, x_1, x_2, x_0)$  be a triplet in  $\Sigma$ . Then, one of the two following properties is satisfied :*

- $\mathcal{I}_{c, \pi} = -0.5$  for all  $e$ -path  $\pi$  with a length 1 which enters  $c$  and  $\mathcal{I}_{c, \pi} = +0.5$  for all  $e$ -path  $\pi$  with a length 1 which exits  $c$ .
- $\mathcal{I}_{c, \pi} = +0.5$  for all  $e$ -path  $\pi$  with a length 1 which enters  $c$  and  $\mathcal{I}_{c, \pi} = -0.5$  for all  $e$ -path  $\pi$  with a length 1 which exits  $c$ .

**Proof:** This lemma is a straightforward consequence of Lemma 19 and Definition 11.  $\square$

**Proof of Proposition 18:** Let  $\pi = (y_k)_{k=0, \dots, p}$  and  $\pi_h = (y_h, y_{h+1})$  for  $h \in \{0, \dots, p-1\}$  so that  $\pi = \pi_0.\pi_1 \dots \pi_{p-1}$ . Since  $c$  is closed, then property  $\mathcal{P}(c, \pi')$  holds and since  $\mathcal{P}(\pi, c)$  holds too, from Proposition 2 we have  $\mathcal{I}_{\pi, c} = -\mathcal{I}_{c, \pi}$ .

Furthermore, since  $c$  is closed, the property  $\mathcal{P}(c, \pi')$  holds for any  $e$ -path  $\pi'$  in  $\Sigma$ . Then, Proposition 15 implies :

$$\mathcal{I}_{c, \pi} = \mathcal{I}_{c, \pi_0} + \mathcal{I}_{c, \pi_1} + \dots + \mathcal{I}_{c, \pi_{p-1}}$$

First, it is immediate that  $\mathcal{I}_{c, \pi_h} = 0$  for any  $h \in \{0, \dots, p-1\}$  such that  $\pi_h$  does not enter neither exits  $c$ . Indeed,  $\mathcal{I}_{c, \pi_h}$  is obviously equal to 0 if  $c^* \cap \pi_h^* = \emptyset$ ; and since  $c$  has a length of 3 it is also immediate (from the Definition 11) that  $\mathcal{I}_{c, \pi_h} = 0$  when  $\pi_h^* \subset c^*$ . Furthermore, since  $\pi$  is either closed or  $c^*$  meets neither  $y_0$  nor  $y_p$  (property  $\mathcal{P}(\pi, c)$ ), it is immediate that the number of  $\pi_h$ 's which enter  $c$  is equal to the number of  $\pi_h$ 's which exit  $c$ . Then, from Lemma 20, it follows that  $\mathcal{I}_{c, \pi} = \sum_{h=0}^{p-1} \mathcal{I}_{c, \pi_h} = 0$ . Finally,  $\mathcal{I}_{\pi, c} = -\mathcal{I}_{c, \pi} = 0$ .  $\square$

**Remark 8** *The intersection number  $\mathcal{I}_{\pi, c}$  of an  $e$ -path  $\pi$  with a triplet  $c$  is either equal to zero or not defined. Indeed, if  $\mathcal{P}(\pi, c)$  is not satisfied, then  $\mathcal{I}_{\pi, c}$  is not defined (see Figure 9).*

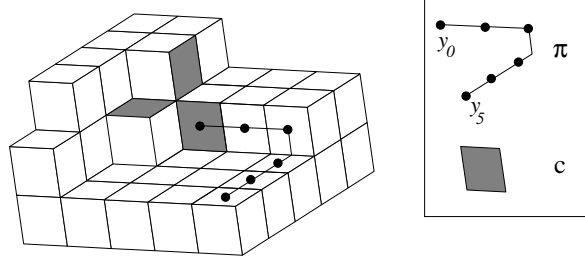

Fig. 9.  $\mathcal{I}_{\pi, c}$  is not defined since  $y_0 \in c^*$ , whereas  $\mathcal{I}_{c, \pi} = \pm 0.5$ .

Now, we can achieve the proof of Theorem 2 for  $n = e$  using Proposition 17, Proposition 15 and Proposition 18.

## 5.2 Proof of Theorem 2 when $(n, \bar{n}) = (e, v)$

Here, we achieve the proof of the main theorem in the case of a  $v$ -homotopic deformation of the  $v$ -path  $c$ .

**Proof of Theorem 2 for  $(n, \bar{n}) = (e, v)$ :** From Proposition 17 it is sufficient to prove Theorem 2 in the case when  $c'$  is an elementary  $\mathcal{T}$ -deformation of  $c$  in  $X$ . Following Definition 16, we may suppose that  $c = c_1.(s).c_2$  and  $c' = c_1.\gamma.c_2$ . Where  $\gamma$  is a back and forth or a triplet from  $s$  to  $s$  in  $X$ . Since  $\mathcal{P}(\pi, c)$  holds, it is straightforward that  $\mathcal{P}(\pi, c_1)$ ,  $\mathcal{P}(\pi, \gamma)$  and  $\mathcal{P}(\pi, c_2)$  hold too. Then, from Proposition 15, we have  $\mathcal{I}_{\pi, c} = \mathcal{I}_{\pi, c_1} + \mathcal{I}_{\pi, \gamma} + \mathcal{I}_{\pi, c_2}$ .

If  $\gamma$  is a back and forth in  $X$ , i.e  $\gamma = (\gamma^0, \gamma^1, \gamma^3)$  where  $\gamma^3 = \gamma^0$ , then it is immediate from Definition 11 that  $\mathcal{I}_{\pi, \gamma}^\pi(0) = 0$  and  $\mathcal{I}_{\pi, \gamma}^\pi(1) = 0$  so that  $\mathcal{I}_{\pi, \gamma} = 0$ . On the other hand, if  $\gamma$  is a triplet, then  $\mathcal{I}_{\pi, \gamma} = 0$  from Proposition 18.

In both cases, it remains that  $\mathcal{I}_{\pi, c} = \mathcal{I}_{\pi, c_1} + \mathcal{I}_{\pi, c_2} = \mathcal{I}_{\pi, c_1.c_2} = \mathcal{I}_{\pi, c'}$ .  $\square$

### 5.3 Another definition of homotopy for $e$ -paths

**Definition 17 ( $e$ -loop)** A parameterization of a loop containing a surfel  $x$  of  $\Sigma$  and which starts at the surfel  $x$  is called an  $e$ -loop from  $x$  to  $x$  in  $\Sigma$  (see Figure 10).

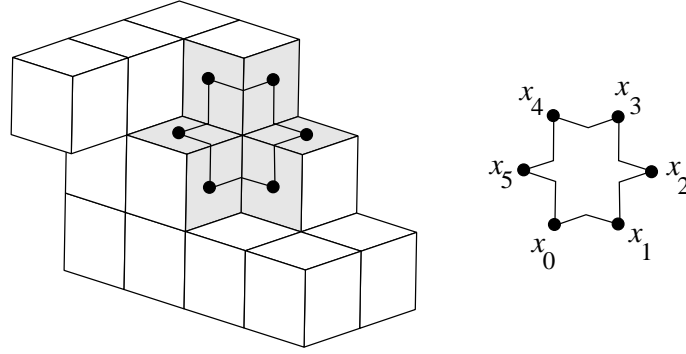

Fig. 10. An  $e$ -loop  $c = (x_0, x_1, x_2, x_3, x_4, x_5, x_0)$  in a digital surface  $\Sigma$ .

First, we introduce the notion of an elementary  $\mathcal{E}$ -deformation and the definition of the  $\mathcal{E}$ -deformation relation follows immediately.

**Definition 18** Let  $X \subset \Sigma$ ,  $c$  and  $c'$  be two  $e$ -paths in  $X$ . The path  $c$  is said to be an elementary  $\mathcal{E}$ -deformation of  $c'$  in  $X$  (and we denote  $c \sim_{\mathcal{E}} c'$ ) if  $c = c_1.(s).c_2$  and  $c' = c_1.\gamma.c_2$ ; or if  $c = c_1.\gamma.c_2$  and  $c' = c_1.(s).c_2$ . Where  $\gamma$  is an  $e$ -loop or a back and forth from  $s$  to  $s$  in  $X$ . In this case, we also say that  $c$  and  $c'$  are the same up to an elementary  $\mathcal{E}$ -deformation. We define the  $\mathcal{E}$ -deformation relation (denoted by  $\simeq_{\mathcal{E}}$ ) as the transitive closure of the elementary  $\mathcal{E}$ -deformation relation.

In other words, the relation of elementary  $\mathcal{E}$ -deformation links together two  $e$ -paths which are almost the same except that one is obtained by insertion in the other of a simple closed  $e$ -path included in a loop. Now, we can state the following proposition :

**Lemma 21** Let  $c$  be an  $e$ -path in  $\Sigma$ . Then, either  $c$  is simple or  $c = c_1.\beta.c_2$  where  $\beta$  is a simple closed path with a length greater then 1.

**Proof:** Let  $c = (x_0, \dots, x_q)$ . Then, if  $c$  is not simple, let  $h \in \{0, \dots, q\}$  and  $l \in \{0, \dots, q\}$  be such that  $x_h = x_l$  and  $l > h$ ; and suppose that  $l$  is minimal for these properties. Thus,  $c = (x_0, \dots, x_h).(x_h, \dots, x_l).(x_l, \dots, x_q)$  and  $(x_h, \dots, x_l)$  is simple.  $\square$

**Lemma 22** Let  $c = (x_i)_{i=0, \dots, q}$  be an  $e$ -path in  $X$  included in a loop  $\mathcal{L}$  of  $\Sigma$ . Then  $c$  is  $\mathcal{E}$ -deformation of a simple path from  $x_0$  to  $x_q$  in  $X$ .

**Proof:** We proceed by an induction on the length of a path  $\alpha^k$  for  $k \geq 0$  with  $\alpha^0 = c$ . Let  $\alpha^k$  be an  $e$ -path in  $X$  with a length  $l_k$  and which is included in  $\mathcal{L}$ . From Lemma 21,

$\alpha^k$  is simple or there exists a simple closed path  $\beta^k$  with a length greater than 1 such that  $\alpha^k = \alpha_1^k \cdot \beta^k \cdot \alpha_2^k$ . Since  $\beta^k$  is obviously included in  $\mathcal{L}$ , then  $\beta^k$  is an  $e$ -loop or a back and forth in  $X$  so that  $\alpha^k$  is an elementary  $\mathcal{E}$ -deformation of the path  $\alpha^{k+1} = \alpha_1^k \cdot \alpha_2^k$ . Furthermore, the path  $\alpha^{k+1}$  has a length  $l_{k+1} < l_k$  since  $\beta^k$  has a length greater than 1. Since the length  $l_k$  is necessary greater than or equal to 0, it follows that there exists an integer  $l \geq 0$  such that  $\alpha^l$  is simple. Furthermore, for  $i = 0, \dots, l-1$ , the path  $\alpha^{i+1}$  is an elementary  $\mathcal{E}$ -deformation of  $\alpha^i$  so that  $\alpha^l$  is an  $\mathcal{E}$ -deformation of  $\alpha^0 = \pi$ .  $\square$

**Lemma 23** *Let  $c = (x_i)_{i=0, \dots, q}$  be an  $e$ -path in  $X$ . The path  $c.c^{-1}$  is an  $\mathcal{E}$ -deformation of the trivial path  $(x_0, x_0)$ .*

**Proof:** Let  $c = (x_0, \dots, x_q)$ . Then, for  $i \in \{0, \dots, q\}$  be denote by  $\beta^i$  the  $e$ -path  $(x_0, x_1, \dots, x_i)$ . We first prove that for all  $j \in \{1, \dots, q\}$  the closed paths  $\beta^j \cdot (\beta^j)^{-1}$  and  $\beta^{j-1} \cdot (\beta^{j-1})^{-1}$  are equivalent up to an elementary  $\mathcal{E}$ -deformation. Indeed, for such  $j$  we have  $\beta^j \cdot (\beta^j)^{-1} = \beta^{j-1} \cdot (x_{j-1}, x_j, x_{j-1}) \cdot (\beta^{j-1})^{-1}$  where  $(x_{j-1}, x_j, x_{j-1})$  is a back and forth. Finally, we obtain that  $c.c^{-1} = \beta^q \cdot (\beta^q)^{-1} \simeq_{\mathcal{E}} \beta^{q-1} \cdot (\beta^{q-1})^{-1} \simeq_{\mathcal{E}} \dots \simeq_{\mathcal{E}} \beta^0 \cdot (\beta^0)^{-1} = (x_0, x_0)$ .  $\square$

**Proposition 24** *Let  $X \subset \Sigma$ . Two  $e$ -paths  $c$  and  $c'$  are  $e$ -homotopic in  $X$  if and only if they are the same up to an  $\mathcal{E}$ -deformation.*

**Proof:** First, an elementary  $\mathcal{E}$ -deformation is a particular case of an elementary  $e$ -deformation where the  $e$ -paths  $\gamma$  and  $\gamma'$ , used in subsection 1.5 to define the elementary  $n$ -deformation, are closed paths ; one of which is reduced to a single surfel and the other one is simple closed  $e$ -path included in a loop, i.e. an elementary deformation cell. It immediately follows that if two  $e$ -paths are the same up to a  $\mathcal{E}$ -deformation then they are  $e$ -homotopic.

Now, it is sufficient to prove that, if two  $e$ -paths are the same up to an elementary  $e$ -deformation in  $X$ , then they are the same up to a  $\mathcal{E}$ -deformation in  $X$ . Let  $c$  and  $c'$  be two  $e$ -paths which are the same up to an elementary  $e$ -deformation, i.e.  $c = c_1 \cdot \gamma \cdot c_2$  and  $c' = c_1 \cdot \gamma' \cdot c_2$  where  $\gamma$  and  $\gamma'$  are two paths in  $X$  with the same extremities and included in a common loop  $\mathcal{L}$ .

From Lemma 22, the path  $\gamma$  [resp.  $\gamma'$ ] is an  $\mathcal{E}$ -deformation of a simple path  $\beta$  [resp.  $\beta'$ ] included in  $\mathcal{L}$ . Then,  $c \simeq_{\mathcal{E}} c_1 \cdot \beta \cdot c_2$  and  $c' \simeq_{\mathcal{E}} c_1 \cdot \beta' \cdot c_2$  where  $\beta$  and  $\beta'$  are simple paths.

If  $\beta = \beta'$ , then it is immediate that  $c \simeq_{\mathcal{E}} c'$ .

Now, if  $\beta$  and  $\beta'$  are not the same but are both closed, then  $\beta$  and  $\beta'$  are simple closed  $e$ -paths in  $\mathcal{L}$  so that  $c_1 \cdot \beta \cdot c_2 \sim_{\mathcal{E}} c_1 \cdot c_2$  and  $c_1 \cdot \beta' \cdot c_2 \sim_{\mathcal{E}} c_1 \cdot c_2$  (Lemma 22). Then,  $c \simeq_{\mathcal{E}} (c_1 \cdot c_2) \simeq_{\mathcal{E}} c'$ .

If  $\beta$  and  $\beta'$  are not the same and also not closed, let  $a$  and  $b$  be the two extremities of  $\beta$  which are distinct. Now, from the very definition of a loop, there exists exactly two distinct simple  $e$ -paths in a loop between two distinct surfels of this loop (see Figure 10). Since  $\beta \neq \beta'$  then  $\beta^* \cap \beta'^* = \{a, b\}$ . It follows that the path  $\beta^{-1} \cdot \beta'$  is a simple closed path from  $b$  to  $b$  in  $\mathcal{L}$ . So  $c_1 \cdot \beta \sim_{\mathcal{E}} c_1 \cdot \beta \cdot \beta^{-1} \cdot \beta' \cdot c_2$ . But from Lemma 23,  $c_1 \cdot \beta \cdot \beta^{-1} \cdot \beta' \cdot c_2 \simeq_{\mathcal{E}} c_1 \cdot \beta' \cdot c_2$  so that  $c_1 \cdot \beta \cdot c_2 \simeq_{\mathcal{E}} c_1 \cdot \beta' \cdot c_2$ . Finally,  $c \simeq_{\mathcal{E}} c'$ .  $\square$

#### 5.4 Intersection number of $e$ -loops

**Proposition 25** *Let  $c$  be an  $e$ -loop in  $\Sigma$ , then  $\mathcal{I}_{c,\pi} = 0$  for any  $v$ -path  $\pi$  on  $\Sigma$  such that  $\mathcal{P}(\pi, c)$  holds.*

**Lemma 26** *Let  $c = (x_i)_{i=0,\dots,q}$  be an  $e$ -loop in  $\Sigma$ . Then, depending on the order of the parameterization of  $c$ , one of the two following properties are satisfied :*

- $\forall i \in \{0, \dots, q\}$ ,  $\text{Left}_c(i) \cap c^* = \emptyset$  and  $\text{Right}_c(i) \subset c^*$ .
- $\forall i \in \{0, \dots, q\}$ ,  $\text{Right}_c(i) \cap c^* = \emptyset$  and  $\text{Left}_c(i) \subset c^*$ .

**Proof:** This lemma comes from local considerations following the very definition of the  $e$ -loops, the canonical parameterization of the  $v$ -neighborhood of a surfel, and the local left and right sets.  $\square$

**Lemma 27** *Let  $c = (x_i)_{i=0,\dots,q}$  be an  $e$ -loop in  $\Sigma$ . Then, depending on the order of the parameterization of  $c$ , one of the two following properties are satisfied :*

- $\mathcal{I}_{c,\pi} = -0.5$  for all  $v$ -path  $\pi$  with a length 1 which enters  $c$  and  $\mathcal{I}_{c,\pi} = +0.5$  for all  $v$ -path  $\pi$  with a length 1 which exits  $c$ .
- $\mathcal{I}_{c,\pi} = +0.5$  for all  $v$ -path  $\pi$  with a length 1 which enters  $c$  and  $\mathcal{I}_{c,\pi} = -0.5$  for all  $v$ -path  $\pi$  with a length 1 which exits  $c$ .

**Proof:** This lemma is a straightforward consequence of Lemma 26.  $\square$

**Proof of Proposition 25:** Let  $\pi = (y_k)_{k=0,\dots,p}$  and  $\pi_h = (y_h, y_{h+1})$  for  $h \in \{0, \dots, p-1\}$  so that  $\pi = \pi_0.\pi_1.\dots.\pi_{p-1}$ . Since  $c$  is closed, the property  $\mathcal{P}(c, \pi')$  holds for any  $v$ -path  $\pi'$  in  $\Sigma$ , then Proposition 15 implies that :

$$\mathcal{I}_{c,\pi} = \mathcal{I}_{c,\pi_0} + \mathcal{I}_{c,\pi_1} + \dots + \mathcal{I}_{c,\pi_{p-1}}$$

First, it is immediate that  $\mathcal{I}_{c,\pi_h} = 0$  for any  $h \in \{0, \dots, p-1\}$  such that  $\pi_h$  does not enter neither exits  $c$ . Indeed,  $\mathcal{I}_{c,\pi_h}$  is obviously equal to 0 when  $\pi_h^* \cap c^* = \emptyset$ ; and in the case when  $\pi_h^* \subset c^*$  then from Lemma 27 we also obtain that  $\mathcal{I}_{c,\pi_h} = 0$ . Furthermore, since  $\pi$  is either closed or  $c^*$  does meet neither  $y_0$  nor  $y_p$  (property  $\mathcal{P}(\pi, c)$ ), it is immediate that the number of  $\pi_h$ 's which enter  $c$  is equal to the number of  $\pi_h$ 's which exit  $c$ . Then, from Lemma 27, it follows that  $\mathcal{I}_{c,\pi} = \sum_{h=0}^{p-1} \mathcal{I}_{c,\pi_h} = 0$ .  $\square$

**Remark 9** *The intersection number  $\mathcal{I}_{c,\pi}$  of an  $e$ -loop  $c$  with a  $v$ -path  $\pi$  may not be equal to zero if  $\mathcal{P}(\pi, c)$  is not satisfied, as depicted in Figure 11.*

#### 5.5 Proof of Theorem 2 when $(n, \bar{n}) = (v, e)$

**Proof of Theorem 2 for  $(n, \bar{n}) = (v, e)$ :** Following Proposition 24, it is sufficient to prove that  $\mathcal{I}_{\pi,c} = \mathcal{I}_{\pi,c'}$  when  $c$  and  $c'$  are two  $e$ -paths which are the same up to an elementary  $\mathcal{E}$ -deformation in  $X$  (in  $X \setminus \{y_0, y_p\}$  if  $\pi$  is not closed). Then, let  $c = c_1.\gamma.c_2$  and  $c' = c_1.(s).c_2 = c_1.c_2$  where  $\gamma$  is an  $e$ -loop or a back and forth from  $s$  to  $s$  in  $X$  (in

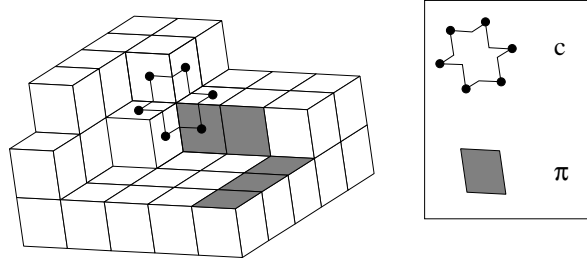

Fig. 11. An  $e$ -loop  $c$  and a  $v$ -path  $\pi$  such that  $\mathcal{I}_{c,\pi} = \pm 0.5$ .

$X \setminus \{y_0, y_p\}$  if  $\pi$  is not closed).

Since  $\mathcal{P}(\pi, c')$  holds, then it is immediate that  $\mathcal{P}(\pi, c_1)$ ,  $\mathcal{P}(\pi, \gamma)$  and  $\mathcal{P}(\pi, c_2)$  hold too. Then, following Property 15,  $\mathcal{I}_{\pi, c_1 \cdot \gamma \cdot c_2} = \mathcal{I}_{\pi, c_1} + \mathcal{I}_{\pi, \gamma} + \mathcal{I}_{\pi, c_2}$ .

If  $\gamma = (y_0, y_1, y_2)$  where  $y_2 = y_0$  is a back and forth in  $X$  (in  $X \setminus \{y_0, y_p\}$  if  $\pi$  is not closed), then it is immediate from Definition 11 and Definition 12 that  $\mathcal{I}_{\pi, \gamma} = 0$ .

If  $\gamma$  is an  $e$ -loop, then  $\mathcal{P}(\gamma, \pi)$  holds together with  $\mathcal{P}(\pi, \gamma)$ . Then, from Proposition 2, we have  $\mathcal{I}_{\pi, \gamma} = -\mathcal{I}_{\gamma, \pi}$  and from Proposition 25  $\mathcal{I}_{\gamma, \pi} = 0$ . Finally,  $\mathcal{I}_{\pi, c'} = \mathcal{I}_{\pi, c_1} + \mathcal{I}_{\pi, c_2}$  and from Proposition 15 it follows that  $\mathcal{I}_{\pi, c'} = \mathcal{I}_{\pi, c_1 \cdot c_2} = \mathcal{I}_{\pi, c}$ .  $\square$

## 6 Topology preservation within digital surfaces

### 6.1 A new theorem about homotopy in digital surfaces

In section 1.4 we have given the definition of homotopy between subsets of a digital surface  $\Sigma$ . In this section, we are interested by a characterization of homotopy which involves the digital fundamental group. The following theorem has been proved in [ML98].

**Theorem 4** *Let  $Y \subset X \subset \Sigma$  be  $n$ -connected sets. Then, the set  $Y$  is  $n$ -homotopic to  $X$  if and only if the two following properties are satisfied:*

- (1) *The morphism  $i_* : \Pi_1^n(Y) \longrightarrow \Pi_1^n(X)$  induced by the inclusion map  $i : Y \longrightarrow X$  is an isomorphism.*
- (2) *Each  $\bar{n}$ -connected component of  $\bar{Y}$  contains a surfel of  $\bar{X}$ .*

And the proof of this theorem uses the following lemma also proved in [ML98].

**Lemma 28** *Let  $X \subset \Sigma$ , and let  $x \in X$  be an  $n$ -simple surfel of  $X$ . Then the group morphism  $i_* : \Pi_1^n(X \setminus \{x\}) \longrightarrow \Pi_1^n(X)$  induced by the inclusion of  $X \setminus \{x\}$  in  $X$  is a group isomorphism.*

We recall the following Lemma which is a straightforward consequence of Theorem 1 (see Section 1.6) and Theorem 4.

**Lemma 29** *Let  $Z$  be an  $n$ -connected subset of  $\Sigma$ , then the following conditions are equivalent:*

- (1) *There exists  $z$  in  $Z$  such that  $\{z\}$  is  $n$ -homotopic to  $Z$ .*
- (2)  *$\bar{Z}$  has exactly one  $\bar{n}$ -connected component and  $\chi_n(Z) = 1$ .*

(3)  $Z \neq \Sigma$  and  $\Pi_1^n(Z) = \{1\}$ .

(4)  $Z \neq \Sigma$  and  $\chi_n(Z) = 1$ .

Now, we define what we call a *topological disk* and a *topological sphere*.

**Definition 19** An  $n$ -connected subset  $Z$  of  $\Sigma$  is called a *topological disk* if it satisfies the four conditions of Lemma 29.

**Definition 20** If  $Z = \Sigma$  and  $\chi_n(Z) = 2$ , we say that  $Z$  is a *topological sphere*.

The purpose of this section is to prove that the condition “ $i_*$  is an isomorphism” of Theorem 4 is sufficient to say that each  $\bar{n}$ -connected component of  $\bar{Y}$  contains a surfel of  $\bar{X}$ , except in the very particular case when  $X$  is the whole surface  $\Sigma$  which is a topological sphere (see Definition 20) and  $Y$  is a disk obtained by removing from  $X$  a topological disk (Definition 19). In other words, except in the above mentioned particular case, condition 2 of Theorem 4 is in fact implied by condition 1 of Theorem 4.

In other words, we prove the following theorem:

**Theorem 5** Let  $Y \subset X \subset \Sigma$  be two  $n$ -connected sets such that  $X \neq \Sigma$  or  $\Sigma$  is not a sphere or  $X \setminus Y$  is not a topological disk, or  $Y$  is not a topological disk, then:

$Y$  is lower  $n$ -homotopic to  $X$  if and only if the morphism  $i_* : \Pi_1^n(Y, B) \longrightarrow \Pi_1^n(X, B)$  induced by the inclusion map  $i : Y \longrightarrow X$  is an isomorphism for any base surfel  $B \in Y$ .

To prove this theorem, we suppose that some  $(X, Y)$  satisfies the condition 1 of Theorem 4, but does not satisfies condition 2 of Theorem 4. In other words, we suppose that  $i_*$  is an isomorphism for any base surfel  $B \in Y$  and we also suppose the existence of an  $\bar{n}$ -connected component of  $\bar{Y}$  which contains no point of  $\bar{X}$ . Namely, we suppose the existence of an  $\bar{n}$ -connected component of  $\bar{Y}$ , denoted by  $A$ , such that  $A \subset X$ . In a first step, we prove that this  $\bar{n}$ -connected component  $A$  is a topological disk. In a second step, we will show by an indirect way that the set  $X \setminus A$  is a topological disk too, in fact equal to  $Y$ , and conclude that  $X = \Sigma$  and  $X$  is a sphere.

In the sequel of this section,  $Y \subset X$  are two  $n$ -connected subsets of a digital surface  $\Sigma$ , and we suppose that for any surfel  $B \in Y$ , the group morphism  $i_*$  between  $\Pi_1^n(Y, B)$  and  $\Pi_1^n(X, B)$  induced by the inclusion map of  $Y$  in  $X$ , is an isomorphism, as in Theorem 4.

In further proof, we will use the following simple Lemma.

**Lemma 30** Let  $Y \subset X$  be two  $n$ -connected subsets of  $\Sigma$  and  $B$  be a surfel of  $Y$ . Then, the two following properties are equivalent :

- i) The morphism  $i_* : \Pi_1^n(Y, B) \longrightarrow \Pi_1^n(X, B)$  induced by the inclusion of  $Y$  in  $X$  is an isomorphism.
- ii) For all surfels  $B'$  in  $Y$ , the morphism  $i'_* : \Pi_1^n(Y, B') \longrightarrow \Pi_1^n(X, B')$  induced by the inclusion of  $Y$  in  $X$  is an isomorphism.

**Proof:** We only have to prove that property i) implies property ii). Suppose that  $i_* : \Pi_1^n(Y, B) \longrightarrow \Pi_1^n(X, B)$  is group isomorphism and let  $B'$  be any surfel of  $Y$ . Then, let  $i'_*$  be the group morphism from  $\Pi_1^n(Y, B')$  to  $\Pi_1^n(X, B')$  induced by the inclusion of  $Y$  in  $X$ . Now, let  $i_Y$  and  $i_X$  be the two canonical group isomorphisms respectively from  $\Pi_1^n(Y, B)$  to  $\Pi_1^n(Y, B')$  and from  $\Pi_1^n(X, B)$  to  $\Pi_1^n(X, B')$  (such isomorphisms exist since  $X$  and  $Y$  are both  $n$ -connected, see subsection 1.5). Clearly, we have  $i'_* = i_X \circ i_* \circ i_Y^{-1}$  so that  $i'_*$

is an isomorphism.  $\square$

## 6.2 First step of the proof

In this section,  $A$  is a connected component of  $\bar{Y}$  which contains no surfel of  $\bar{X}$  (i.e.  $A \subset X$ ) and  $B$  is a surfel of  $Y$  ( $B$  is the base surfel of the digital fundamental groups which are considered in this section).

**Lemma 31** *There exists a surfel  $x_0 \in A$  such that the morphism :*

$$i_*' : \Pi_1^n(Y \cup (A \setminus \{x_0\}), B) \longrightarrow \Pi_1^n(X, B)$$

*induced by the inclusion map  $i'' : Y \cup (A \setminus \{x_0\}) \longrightarrow X$  is an isomorphism and  $Y$  is lower  $n$ -homotopic to  $Y \cup (A \setminus \{x_0\})$ .*

**Corollary 32** *The set  $\{x_0\}$  is  $\bar{n}$ -homotopic to  $A$ , so that  $A$  is a topological disk for the  $\bar{n}$ -adjacency relation.*

Before to prove Lemma 31, we have to prove two preliminary results.

**Lemma 33** *Let  $x_0$  be a surfel of  $A$ . If  $A$  is composed of at least 2 surfels, then there exists a surfel  $x \neq x_0$  in  $A$  which is  $n$ -adjacent to  $Y$  and which is  $n$ -simple for  $Y \cup \{x\}$ .*

**Corollary 34** *Let  $x_0$  be a surfel of  $A$ . If  $A$  is composed of at least 2 surfels, then there exists a surfel  $x \neq x_0$  in  $A$  which is  $n$ -adjacent to  $Y$  and which is  $\bar{n}$ -simple for  $A$ .*

**Proof:** From Lemma 33, there exists a surfel  $x \neq x_0$  in  $A$  which is  $n$ -adjacent to  $Y$  and  $n$ -simple for  $Y \cup \{x\}$ . Then,  $x$  is neither  $n$ -isolated in  $Y \cup \{x\}$  nor  $n$ -interior to  $Y \cup \{x\}$  (since  $A \subset \bar{Y}$  is  $\bar{n}$ -connected and  $x \neq x_0$ ). Then, following Remark 2 and since  $x$  is  $n$ -simple for  $Y \cup \{x\}$  we have  $\text{Card}(\mathcal{C}_n^x[G_n(x, Y \cup \{x\})]) = \text{Card}(\mathcal{C}_n^x[G_{\bar{n}}(x, \overline{Y \cup \{x\}})]) = 1$ . Now, since  $x \in A$  cannot be  $\bar{n}$ -adjacent to any other  $\bar{n}$ -connected component of  $\bar{Y}$  than  $A$ , it follows that  $\mathcal{C}_{\bar{n}}^x[G_{\bar{n}}(x, \overline{Y \cup \{x\}})] = \mathcal{C}_{\bar{n}}^x[G_{\bar{n}}(x, A)]$ . Now, since  $x$  is  $n$ -adjacent to  $Y$  it is not  $\bar{n}$ -interior to  $A$  then  $x$  is  $\bar{n}$ -simple for  $A$ .  $\square$

**Proof of Lemma 33:** Let  $x$  be a surfel of  $A \subset \bar{Y}$  which is  $n$ -adjacent to  $Y$  and whose distance to  $x_0$  is maximal among all surfels of  $A$  which are  $n$ -adjacent to  $Y$ . The distance used here is the length of a shortest  $n$ -path in  $A$  between two surfels. Let us prove that the surfel  $x$  is  $n$ -simple for  $Y \cup \{x\}$ . We have  $G_n(x, Y \cup \{x\}) = G_n(x, Y)$  and  $G_{\bar{n}}(x, \bar{Y} \setminus \{x\}) = G_{\bar{n}}(x, \bar{Y})$ . Suppose that this surfel  $x$  is not  $n$ -simple for  $Y \cup \{x\}$ . Since  $x$  is neither  $n$ -isolated nor  $n$ -interior to  $Y \cup \{x\}$ , this implies that  $\text{Card}(\mathcal{C}_n^x(G_n(x, Y))) = \text{Card}(\mathcal{C}_{\bar{n}}^x(G_{\bar{n}}(x, \bar{Y}))) \geq 2$  (Remark 2). Let  $a$  and  $b$  be two surfels  $n$ -adjacent to  $x$  in two distinct  $n_x$ -connected components of  $G_n(x, Y)$  which are  $n$ -adjacent to  $x$ .

Let us denote by  $\pi_0$  the  $n$ -path  $(b, x, a)$ . Since  $a$  and  $b$  are  $n$ -adjacent to  $x$  and do not belong to the same  $n_x$ -connected component of  $N_v(x) \cap Y$ ,  $a$  is not  $n_x$ -adjacent to  $b$ .

Following Remark 5 it follows that none of the sets  $Left_{\pi_0}(1)$  and  $Right_{\pi_0}(1)$  is empty and each one contains a surfel which is  $\bar{n}$ -adjacent to  $x$ . Furthermore, if we suppose that all the surfels of  $Left_{\pi_0}(1)$  or  $Right_{\pi_0}(1)$  which are  $\bar{n}$ -adjacent to  $x$  belong to  $Y$ , it is immediate that the two surfels  $a$  and  $b$  are  $n_x$ -connected in  $N_v(x) \cap Y$ . Then, there must exist two surfels  $s_1$  and  $s_2$  which are  $\bar{n}$ -adjacent to  $x$  such that  $s_1 \in Right_{\pi_0}(1) \cap A$  and  $s_2 \in Left_{\pi_0}(1) \cap A$ . Moreover, we may assume that  $s_1$  and  $s_2$  are  $n$ -adjacent to  $Y$ . Since



the set  $Y$  is  $n$ -connected, there exists an  $n$ -path  $\beta_1$  from  $a$  to  $B$  in  $Y$  and an  $n$ -path  $\beta_2$  from  $B$  to  $b$  in  $Y$ .

Now, an  $\bar{n}$ -path  $\alpha_1 = (s_1, \dots, x_0)$  in  $A \setminus \{x\}$  from  $s_1$  to the surfel  $x_0$  must exist since the  $\bar{n}$ -distance between  $x$  and  $x_0$  is maximal among all surfels of  $A$  which are  $n$ -adjacent to  $Y$ . Indeed, otherwise, let  $c$  be a shortest  $\bar{n}$ -path with a length  $l$  between  $x$  and  $x_0$  in  $A$ . If  $s_1$  is not  $\bar{n}$ -connected to  $x_0$  in  $A \setminus \{x\}$  and since  $s_1$  is  $\bar{n}$ -adjacent to  $x$ , then  $s_1$  is at a distance of  $l + 1$  from  $x_0$  in  $A$ . This contradicts the fact that  $x$  is at a maximal distance  $l$  from  $x_0$  among all the surfels of  $A$  which are  $n$ -adjacent to  $Y$ . Similarly, there must exist an  $\bar{n}$ -path  $\alpha_2 = (s_2, \dots, x_0)$  from  $s_2$  to  $x_0$  in  $A \setminus \{x\}$ .

Let  $\alpha$  be the closed  $\bar{n}$ -path  $\alpha = (x).\alpha_1.\alpha_2^{-1}.(x)$  in  $A$ . Note that, from the very construction of  $\alpha_1$  and  $\alpha_2$ , we have  $x \notin \alpha_1^*$  and  $x \notin \alpha_2^*$ . We can also construct a closed  $n$ -path  $\beta = (B).\beta_2.\pi_0.\beta_1.(B)$  from  $B$  to  $B$  in  $Y \cup \{x\}$  with  $\pi_0 = (b, x, a)$  and  $x \notin \beta_1^* \cup \beta_2^*$  since  $\beta_1$  and  $\beta_2$  are  $n$ -paths in  $Y$ . We deduce that the two paths  $\alpha$  and  $\beta$  only cross each other one time in  $x$ , and since  $s_1 \in \text{Right}_{\pi_0}(1)$  and  $s_2 \in \text{Left}_{\pi_0}(1)$ , we have  $\mathcal{I}_{\alpha,\beta} = -\mathcal{I}_{\beta,\alpha} = 1$ .

Now, since the morphism  $i_*$  from  $\Pi_1^n(Y, B)$  to  $\Pi_1^n(X, B)$  induced by the inclusion of  $Y$  in  $X$  is an isomorphism. In particular,  $i_*$  is onto and then, for any equivalence class  $[c']_{\Pi_1^n(X, B)}$ , there exists a closed  $n$ -path  $c \in A_n^B(Y)$  which is  $n$ -homotopic to  $c'$  in  $X$  so that  $i_*([c]_{\Pi_1^n(Y, B)}) = [c']_{\Pi_1^n(X, B)}$ . In our case, there exists an  $n$ -path  $\gamma \in A_n^B(Y)$  which is  $n$ -homotopic to the  $n$ -path  $\beta$  in  $X$  and  $i_*([\gamma]_{\Pi_1^n(Y, B)}) = [\beta]_{\Pi_1^n(X, B)}$ . If  $\gamma$  is  $n$ -homotopic to  $\beta$  in  $X$ , and from Theorem 2, we deduce that  $\mathcal{I}_{\alpha,\beta} = \mathcal{I}_{\alpha,\gamma} = 1$ . But since  $\alpha$  is an  $\bar{n}$ -path in  $A \subset \bar{Y}$  and  $\gamma$  is an  $n$ -path in  $Y$ , we have  $\gamma^* \cap \alpha^* = \emptyset$  and then  $\mathcal{I}_{\alpha,\gamma} = 0$  and we obtain a contradiction. Finally, the point  $x$  must be  $n$ -simple for  $Y \cup \{x\}$ .  $\square$

**Remark 10** *If  $x$  is an  $n$ -simple surfel for  $Y \cup \{x\}$ , then, since  $x$  is  $\bar{n}$ -simple in  $A$  the set  $A \setminus \{x\}$  is  $\bar{n}$ -connected.*

**Proof of Lemma 31:** By induction of Lemma 33 (and using Lemma 28) we show that there exists a sequence of surfels  $(s_0, \dots, s_l)$  such that for all  $i \in \{0, \dots, l\}$ ,  $s_i \in A$  is  $n$ -simple for  $Y \cup \{s_0, \dots, s_i\}$  and  $A \setminus \{s_0, \dots, s_l\} = \{x_0\}$ . Therefore,  $Y$  is lower  $n$ -homotopic to  $Y \cup (A \setminus \{x_0\})$ .

From Lemma 28, the morphism  $i_*^i : \Pi_1^n(Y \cup \{s_0, \dots, s_{i-1}\}, B) \longrightarrow \Pi_1^n(Y \cup \{s_0, \dots, s_i\}, B)$  induced by the inclusion of  $Y \cup \{s_0, \dots, s_{i-1}\}$  in  $Y \cup \{s_0, \dots, s_i\}$  is a group isomorphism. On the other hand, the morphism  $i_*^i : \Pi_1^n(Y, B) \longrightarrow \Pi_1^n(Y \cup \{s_i | i = 0, \dots, l\} = Y \cup (A \setminus \{x_0\}), B)$  induced by the inclusion map  $i' : Y \longrightarrow Y \cup (A \setminus \{x_0\})$  is such that  $i_*^i = i_*^i \circ \dots \circ i_*^0$ . Therefore, the morphism  $i_*^i$  is an isomorphism. Furthermore, since  $i_*$  is an isomorphism, then  $i_*^{i'} = i_* \circ i_*^{i'-1}$  is an isomorphism from  $\Pi_1^n(Y \cup (A \setminus \{x_0\}), B)$  to  $\Pi_1^n(X, B)$ .  $\square$

### 6.3 Second step of the proof

In Section 6.2 we have proved that  $Y$  is lower  $n$ -homotopic to  $Y \cup (A \setminus \{x_0\})$  where  $x_0$  is an isolated surfel of  $Y \cup (A \setminus \{x_0\})$ . In this section, we will state that, under the condition that the  $n$ -path surrounding  $\{x_0\}$  in  $Y \cup (A \setminus \{x_0\})$  is  $n$ -reducible in  $Y \cup (A \setminus \{x_0\})$ ,

then  $Y \cup (A \setminus \{x_0\})$  is a topological disk.

#### 6.4 Edgel borders of a connected subset $X \subset \Sigma$

First, we have to define explicitly what we call a “border” of a connected set of surfels. Let  $X$  be an  $n$ -connected subset of a surface  $\Sigma$ .

**Definition 21 (border edgel)** We call a border edgel of  $X$  any couple  $(x, y)$  of surfels of  $\Sigma$  such that  $x \in X$  and  $y \in \bar{X}$ . We denote by  $\mathcal{B}(X)$  the set of border edgels of  $X$ .

**Definition 22 ( $s$ -adjacency relation)** We say that two border edgels  $(x, y)$  and  $(x', y')$  of  $\mathcal{B}(X)$  are  $s$ -adjacent if the three following conditions are satisfied :

- $x, y, x'$  and  $y'$  belong to a common loop  $\mathcal{L}$  of  $\Sigma$ .
- $x \neq x'$  or  $y \neq y'$ .
- $x$  is  $e$ -connected to  $x'$  in  $\mathcal{L} \cap X$  if  $n = e$ , and  $y$  is  $e$ -connected to  $y'$  in  $\mathcal{L} \cap \bar{X}$  if  $n = v$ .

We can define the  $s$ -connectivity between border edgels as the transitive closure of this adjacency relation. The definition of an  $s$ -path of border edgels also comes immediately. Note that any  $s$ -connected component of border edgels of  $X$  is a simple closed curve (i.e. each border edgel has exactly two  $s$ -neighbors, one per loop which contains this border edgel) and is called a border of  $X$ , whereas a parameterization of such a simple closed curve is called a parameterized border of  $X$ .

**Definition 23 ( $n$ -path  $c_n(s)$ )** Let  $s = (s_0 = (x_0, y_0), \dots, s_l = (x_l, y_l))$  be a  $s$ -path of border edgels of  $X$ . We define the  $n$ -path associated with  $s$  denoted by  $c_n(s)$  according to the following cases :

- If  $n = e$  and for  $i \in \{0, \dots, l-1\}$ , we call  $c_i$  the shortest  $e$ -path joining  $x_i$  to  $x_{i+1}$  in  $X \cap \mathcal{L}$ , where  $\mathcal{L}$  is the unique loop containing  $\{x_i, x_{i+1}, y_i, y_{i+1}\}$  (path which exists according to the definition of the  $s$ -adjacency between  $s_i$  and  $s_{i+1}$ ). Then  $c_e(s) = c_0 * \dots * c_{l-1}$ .
- If  $n = v$  and for  $i \in \{0, \dots, l-1\}$ , then  $x_i$  is  $v$ -adjacent to  $x_{i+1}$ . We define  $c_v(s) = (x_0, \dots, x_l)$ .

**Remark 11** For any  $s$ -path of border edgels  $s = (s_0 = (x_0, y_0), \dots, s_l = (x_l, y_l))$  of  $X \subset \Sigma$  and  $n \in \{e, v\}$ , all the surfels of  $c_n(s)$  are  $\bar{n}$ -adjacent to  $\bar{X}$ .

#### 6.5 Free group

In the following, we will use the notion of the (non-Abelian) *free group with  $m$  generators*. Let  $\mathcal{A} = \{a_1, \dots, a_m\} \cup \{a_1^{-1}, \dots, a_m^{-1}\}$  be an alphabet with  $2m$  distinct letters, and let  $\mathcal{W}_m$  be the set of all words over this alphabet (i.e. finite sequences of letters of the alphabet). We say that two words  $w \in \mathcal{W}_m$  and  $w' \in \mathcal{W}_m$  are *the same up to an elementary cancellation* if one can be obtained by inserting or deleting in the other a sequence of the form  $a_i^{-1}a_i$  or a sequence of the form  $a_i a_i^{-1}$  with  $i \in \{1, \dots, m\}$ . Now, two words  $w \in \mathcal{W}_m$  and  $w' \in \mathcal{W}_m$  are said to be *free equivalent* if there is a finite sequence  $w = w_1, \dots, w_k = w'$  of words of  $\mathcal{W}_m$  such that for  $i = 2, \dots, k$  the words  $w_{i-1}$  and  $w_i$  are the same up to an elementary cancellation. This defines an equivalence relation on  $\mathcal{W}_m$  and

we denote by  $\mathcal{F}_m$  the set of equivalence classes of this equivalence relation. Furthermore, if  $w$  is a word of  $\mathcal{W}_m$ , we denote by  $\bar{w}$  the equivalence class of the word  $w$  following the latter equivalence relation. The concatenation of words defines an operation on  $\mathcal{F}_m$  which provides  $\mathcal{F}_m$  with a group structure (we define  $\overline{w_1 w_2} = \bar{w}_1 \bar{w}_2$ ). The group thus defined is called the *free group* with  $m$  generators over  $\mathcal{A}$ . Classically, we denote by  $w_1.w_2$  the word obtained by concatenation of the words  $w_1$  and  $w_2$ .

We denote by  $1_m$  the unit element of  $\mathcal{F}_m$  which is equal to  $\bar{\epsilon}$  where  $\epsilon$  is the empty word. The only result which we shall admit on the free group is the classical result that if a word  $w \in \mathcal{L}_m$  is such that  $\bar{w} = 1_m$  and  $w$  is not the empty word, then there exists in  $w$  two successive letters  $a_i a_i^{-1}$  or  $a_i^{-1} a_i$  with  $i \in \{1, \dots, m\}$ . This remark leads to an immediate algorithm to decide whether a word  $w \in \mathcal{W}_m$  is such that  $\bar{w} = 1_m$  by successive cancellations.

### 6.6 Free group element associated with a path

In the sequel  $X = \{x_1, \dots, x_l\}$  is an  $n$ -connected subset of  $\Sigma$  with cardinality  $l > 1$ .

**Notation 6** If  $x$  is a surfel of  $X$ , we abbreviate and denote by  $o(x)$  the cardinality of  $\mathcal{C}_n^x[G_n(x, X)]$ , set of  $n_x$ -connected components of  $N_v(x) \cap X$  which are  $n$ -adjacent to  $x$ . We observe that  $o(x_i)$  may be at most equal to 4. Then, we may assign a number  $t$  in  $\{1, \dots, o(x_i)\}$  to each element of  $\mathcal{C}_n^{x_i}[G_n(x_i, X)]$  so that it makes sense to talk of the  $t^{\text{th}}$  element of  $\mathcal{C}_n^{x_i}[G_n(x_i, X)]$ .

**Definition 24 (alphabet  $\mathcal{A}_X$ )** Now, we define the alphabet  $\mathcal{A}_X$  as follows :

$$\begin{aligned} \mathcal{A}_X = & \{x_{1,1}, \dots, x_{1,o(x_1)}, x_{2,1}, \dots, x_{2,o(x_2)}, \dots, x_{l,1}, \dots, x_{l,o(x_l)}\} \\ & \cup \{x_{1,1}^{-1}, \dots, x_{1,o(x_1)}^{-1}, x_{2,1}^{-1}, \dots, x_{2,o(x_2)}^{-1}, \dots, x_{l,1}^{-1}, \dots, x_{l,o(x_l)}^{-1}\} \end{aligned}$$

Where the symbols  $\{x_{i,1}, \dots, x_{i,o(i)}\}$  are associated to the surfel  $x_i$ , and the symbol  $x_{i,j}$  is associated to the  $j^{\text{th}}$  element of  $\mathcal{C}_n^{x_i}[G_n(x_i, X)]$ .

**Definition 25 (word associated to a path)** If  $\pi = (y_0, y_1)$  is an  $n$ -path in  $X$  with a length 1 such that  $y_0 = x_a$  and  $y_1 = x_b$  for  $\{a, b\} \subset \{0, \dots, l\}$ . We associate to  $\pi$  a word  $w_n(\pi, X)$  of the alphabet  $\mathcal{A}_X$  defined by  $w_n(\pi, X) = x_{a,t} x_{b,u}^{-1}$  where  $t$  and  $u$  are such that  $x_b$  belongs to the  $t^{\text{th}}$  element of  $\mathcal{C}_n^{x_a}[G_n(x_a, X)]$  and  $x_a$  belongs to the  $u^{\text{th}}$  element of  $\mathcal{C}_n^{x_b}[G_n(x_b, X)]$ .

If  $\pi = (y_k)_{k=0, \dots, p}$  is an  $n$ -path with a length  $q > 1$  in  $X$ , we define the word  $w_n(\pi, X)$  as follows :

$$w_n(\pi, X) = w_n((y_0, y_1), X) w_n((y_1, y_2), X) w_n((y_2, y_3), X) \dots w_n((y_{p-1}, y_p), X)$$

And we define  $w_n(\pi, X)$  to be the empty word if  $\pi$  is of length 0 or is a trivial path.

**Definition 26 (free group element associated to a path)** If  $\pi$  is an  $n$ -path in  $X$  and  $\mathcal{A}_X$  has a cardinality of  $2m$ . We define the element  $\nu_n(\pi, X)$  of the free group with  $m$  generators over  $\mathcal{A}_X$  by :  $\nu_n(\pi, X) = \overline{w_n(\pi, X)}$ .

**Remark 12** If  $\pi_1$  and  $\pi_2$  are two  $n$ -paths in  $X$  such that the last surfel of  $\pi_1$  is equal to the first surfel of  $\pi_2$ . Then,  $w_n(\pi_1.\pi_2, X) = w_n(\pi_1, X)w_n(\pi_2, X)$

**Remark 13** If  $\pi$  is an  $n$ -path in  $X$ , then, from its very construction,  $w_n(\pi, X)$  cannot contain some pair  $x_{i,t}x_{i,t}^{-1}$  for  $i \in \{0, \dots, l\}$  and  $t \in \{1, \dots, o(x_i)\}$ .

**Proposition 35** Let  $X$  be an  $n$ -connected subset of  $\Sigma$  with at least two surfels. Let  $\pi$  and  $\pi'$  be two  $n$ -paths in  $X$ . If  $\pi \simeq_n \pi'$  then  $\nu(\pi, X) = \nu(\pi', X)$ .

The proof of Proposition 35 relies on the three following lemmas.

**Lemma 36** If  $\pi$  is an  $n$ -back and forth in  $X$ , then  $\nu_n(\pi, X) = 1_{2m}$ .

**Proof:** Let  $\pi = (y_0, y_1, y_0)$  be an  $n$ -back and forth in  $X$  such that  $y_0 = x_a$  and  $y_1 = x_b$ . From Definition 26,  $w_n(\pi, X) = x_{a,u}x_{b,t}^{-1}x_{b,t}x_{a,u}^{-1}$  if  $y_1$  belongs to the  $t^{\text{th}}$  element of  $\mathcal{C}_n^{y_0}[G_n(y_0, X)]$ ; and  $y_0$  belongs to the  $u^{\text{th}}$  element  $\mathcal{C}_n^{y_1}[G_n(y_1, X)]$ . Finally, it is immediate that  $w_n(\pi, X) = 1_{2m}$ .  $\square$

**Lemma 37** If  $\pi$  is a triplet in  $X$ , then  $\nu_v(\pi, X) = 1_{2m}$ .

**Proof:** Let  $\pi = (y_0, y_1, y_2, y_0)$  be a triplet in  $X$ . Then, we may suppose without loss of generality (up to a new numbering of  $X$ ) that  $y_0 = x_0$ ,  $y_1 = x_1$  and  $y_2 = x_2$ . Since  $y_0$ ,  $y_1$  and  $y_2$  belong to a common loop, the surfels  $y_1$  and  $y_2$  belong to the same element of  $\mathcal{C}_v^{y_0}[G_v(y_0, X)]$  (say the first one, still without loss of generality); the two surfels  $y_0$  and  $y_2$  belong to the same (say the second) element of  $\mathcal{C}_v^{y_1}[G_v(y_1, X)]$ ; and the two surfels  $y_0$  and  $y_1$  belong to the same (say the third) element of  $\mathcal{C}_v^{y_2}[G_v(y_2, X)]$ . Thus,  $w_v((y_0, y_1), X) = x_{0,1}x_{1,2}^{-1}$ ,  $w_v((y_1, y_2), X) = x_{1,2}x_{2,3}^{-1}$ , and  $w_v((y_2, y_0), X) = x_{2,3}x_{0,1}^{-1}$  so that  $w(\pi, X) = x_{0,1}x_{1,2}^{-1}x_{1,2}x_{2,3}^{-1}x_{2,3}x_{0,1}^{-1}$ . Then,  $\overline{w(\pi, X)} = \overline{x_{0,1}x_{1,2}^{-1}x_{1,2}x_{2,3}^{-1}x_{2,3}x_{0,1}^{-1}} = \overline{x_{0,1}x_{2,3}^{-1}x_{2,3}x_{1,0}^{-1}} = \overline{x_{1,0}x_{1,0}^{-1}} = 1_{2m}$ .  $\square$

**Lemma 38** If  $\pi$  is an  $e$ -loop in  $X$ , then  $\nu_e(\pi, X) = 1_{2m}$ .

**Proof:** Let  $\pi = (y_0, \dots, y_p)$  be an  $e$ -loop in  $X$ . First, we observe that  $p > 2$  and we may suppose that  $y_i = x_i$  for all  $i \in \{0, \dots, p\}$ . Then, from Definition 25 we have  $w_v(\pi, X) = w_v((x_0, x_1), X).w_v((x_1, x_2), X) \dots .w_v((x_{p-1}, x_p), X)$ .

Furthermore, for all  $k \in \{1, \dots, p-1\}$  let us denote by  $\sigma(k)$  the number of the element of  $\mathcal{C}_v^{x_k}[G_v(x_k, X)]$  which contains the surfel  $x_{k-1}$ . Then, from the very definition of an  $e$ -loop in  $X$ , it is immediate that  $\sigma(k)$  is also the number of the element of  $\mathcal{C}_v^{x_k}[G_v(x_k, X)]$  which contains the surfel  $x_{k+1}$  (indeed,  $x_{k-1}$  and  $x_{k+1}$  are both  $e$ -connected in  $\pi^* \subset N_v(x_k) \cap X$ ). On the other hand, it is also obvious that  $x_1$  and  $x_{p-1}$  both belong to the same element of  $\mathcal{C}_v^{x_0}[G_v(x_0, X)]$ , say the first one. It follows that :

$$w_v(\pi, X) = x_{0,1}x_{1,\sigma(1)}^{-1}x_{1,\sigma(1)}x_{2,\sigma(2)}^{-1}x_{2,\sigma(2)}x_{3,\sigma(2)}^{-1} \cdots x_{p-1,\sigma(p-1)}^{-1}x_{p-1,\sigma(p-1)}x_{0,1}^{-1}$$

And then :  $\overline{w_v(\pi, X)} = \overline{x_{0,1}x_{0,1}^{-1}} = 1_{2m}$ .  $\square$

**Proof of Proposition 35:**

Following Proposition 24 and Proposition 17, it is sufficient to prove this proposition in the case when  $\pi$  and  $\pi'$  are the same up to an elementary  $\mathcal{T}$ -deformation when  $n = v$  and the same up to an elementary  $\mathcal{S}$ -deformation when  $n = e$ .

If  $n = e$  we suppose that  $\pi = \pi_1.(s).\pi_2$  and  $\pi' = \pi_1.\gamma.\pi_2$  where  $\gamma$  is an  $e$ -back and forth or an  $e$ -loop in  $X$ . Then, following Remark 12 we have  $\nu_e(\pi, X) = \overline{w_e(\pi_1, X)w_e(\pi_2, X)}$  and  $\nu_e(\pi', X) = \overline{w_e(\pi_1, X)w_e(\gamma, X)w_e(\pi_2, X)}$ . Now, from Lemma 36 and Lemma 38, we have  $\overline{w_e(\gamma, X)} = 1_{2m}$  and it follows that  $\overline{w_e(\pi_1, X)w_e(\gamma, X)w_e(\pi_2, X)} = \overline{w_e(\pi_1, X)w_e(\pi_2, X)}$ . Finally,  $\nu_e(\pi, X) = \nu_e(\pi', X)$ .

If  $n = v$  we suppose that  $\pi = \pi_1.(s).\pi_2$  and  $\pi' = \pi_1.\gamma.\pi_2$  where  $\gamma$  is a  $v$ -back and forth or a triplet in  $X$ . Then, following Remark 12 we have  $\nu_v(\pi, X) = \overline{w_v(\pi_1, X)w_v(\pi_2, X)}$  and  $\nu_v(\pi', X) = \overline{w_v(\pi_1, X)w_v(\gamma, X)w_v(\pi_2, X)}$ . Now, from Lemma 36 and Lemma 37, we have  $\overline{w_v(\gamma, X)} = 1_{2m}$  and it follows that  $\overline{w_v(\pi_1, X)w_v(\gamma, X)w_v(\pi_2, X)} = \overline{w_v(\pi_1, X)w_v(\pi_2, X)}$ . Finally,  $\nu_v(\pi, X) = \nu_v(\pi', X)$ .  $\square$

## 6.7 Important lemmas

The main result of this section is constituted by the following proposition :

**Proposition 39** *Let  $Y$  be an  $n$ -connected subset of  $\Sigma$  and  $x_0$  be an  $\bar{n}$ -isolated surfel of  $\bar{Y}$  (i.e.  $x_0$  has no  $\bar{n}$ -neighbor in  $\bar{Y}$ ). Let  $s$  be the  $s$ -curve  $((a, x_0), (b, x_0), (c, x_0), (d, x_0))$  where  $a, b, c$  and  $d$  are the appropriately named four  $e$ -neighbors of  $x_0$  in  $Y$ . If  $c_n(s)$  is  $n$ -homotopic to a trivial path in  $Y$ , then  $Y$  is a topological disk.*

In the sequel of this section,  $Y$  is an  $n$ -connected subset of  $\Sigma$  and  $s$  is a parameterized border of  $Y$  (i.e.  $s$  is a parameterization of a simple closed  $s$ -curve of border edges of  $Y$ ). In order to prove Proposition 39, we must state the following lemmas.

**Lemma 40** *If the  $n$ -path  $c_n(s)$  is  $n$ -homotopic in  $Y$  to a trivial path and  $(c_n(s))^*$  has more than one surfel then  $c_n(s)$  contains a surfel which is  $n$ -simple for  $Y$ .*

In order to prove Lemma 40, we first state the following lemma.

**Lemma 41** *If  $w_n(c_n(s), X)$  contains a pair  $x_{i,k}^{-1}x_{i,k}$  for some  $i$  in  $\{1, \dots, l\}$  and some  $k$  in  $\{1, \dots, o(x_j)\}$  then the surfel  $c^k$  of  $c_n(s)$  such that  $x_i = c^k$  is  $n$ -simple for  $X$ .*

**Proof:** If  $x_{j,b}^{-1}x_{j,b}$  occurs in  $w_n(c_n(s), X)$ , then more precisely and from Definition 25,  $x_{k,u}x_{j,b}^{-1}x_{j,b}x_{k',t}$  occurs for some  $k$  and  $k'$  in  $\{1, \dots, l\}$ ,  $u$  in  $\{1, \dots, o(x_k)\}$  and  $t$  in  $\{1, \dots, o(x_{k'})\}$ . It means that there exists in  $c_n(s)$  a subsequence  $(c^p, \dots, c^{p+q})$  such that :

- $w_n((c^p, \dots, c^{p+q}), X) = (w_n((c^p, c^{p+1}), X) \dots w_n((c^{p+q-1}, c^{p+q}), X) = x_{j,b}^{-1}x_{j,b}$ .
- $c^p = x_k$  belongs to the  $b^{th}$  element of  $\mathcal{C}_n^{x_j}[G_n(x_j, X)]$ , and  $x_j$  belongs to the  $u^{th}$  element of  $\mathcal{C}_n^{x_k}[G_n(x_k, X)]$ .
- $c^{p+q} = x_{k'}$  belongs to the  $b^{th}$  element of  $\mathcal{C}_n^{x_j}[G_n(x_j, X)]$ ; and  $x_j$  belongs to the  $t^{th}$  element of  $\mathcal{C}_n^{x_{k'}}[G_n(x_{k'}, X)]$ .
- $c^k = x_j$  for all  $k \in \{p+1, \dots, p+q\}$

In other words, the parameterized border comes from an  $n_i$ -connected component of  $G_n(x_i, X)$  to  $x_i$  and exits from  $x_i$  to the same  $n_{x_i}$ -connected component of  $G_n(x_i, X)$ . It is then immediate that  $G_n(x_i, X)$  has a single  $n_{x_i}$ -connected component (see Figure 12)  $n$ -adjacent to  $x_i$  which is itself  $\bar{n}$ -adjacent to a surfel of  $\bar{X}$  (Remark 11). Then,  $x_i$  is  $n$ -simple for  $X$ .  $\square$

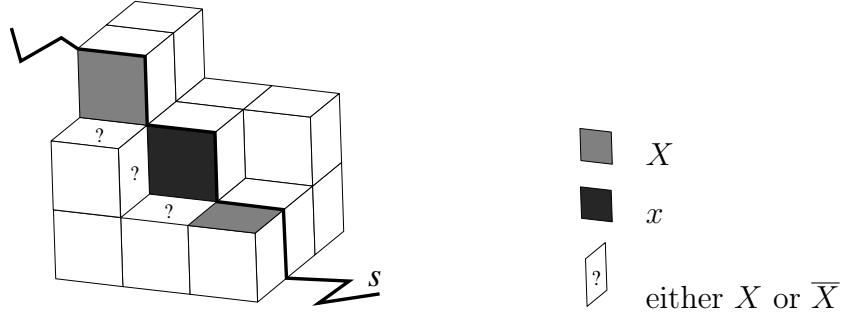
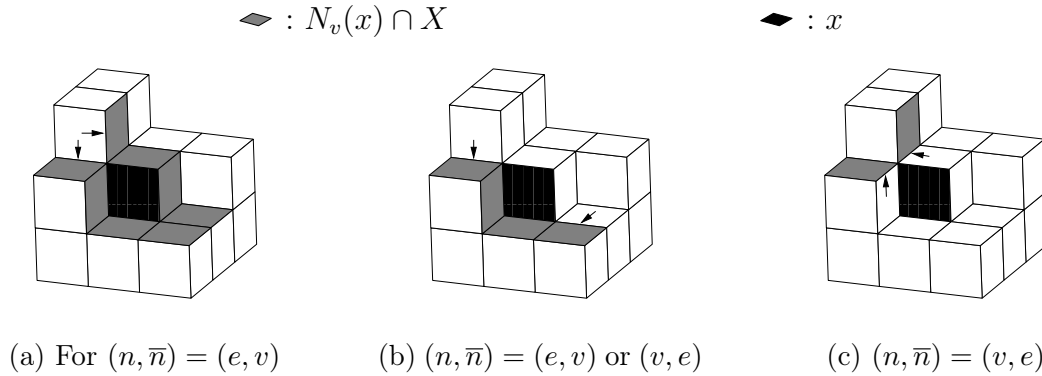

Fig. 12. If the two grey surfels belong to the same  $v_x$ -connected of  $G_v(x, X)$  it is clear that  $\text{Card}(\mathcal{C}_v^x[G_v(x, X)]) = 1$  and  $\text{Card}(\mathcal{C}_e^x[G_e(x, \bar{X})]) = 1$ .

**Proof of Lemma 40:** Since  $c_n(s)$  is closed and has a length greater than 1 it follows that  $w_n(c_n(s), X)$  is a word on  $\mathcal{A}_X$  with a length (number of symbols) greater or equal to 4 (see Definition 25). Now, since  $c_n(s)$  is  $n$ -homotopic to a trivial path in  $Y$ , it follows from Proposition 35 and Definition 25 for a word associated to a trivial path, that  $\overline{w_n(c_n(s), X)} = 1_{2m}$ . Then,  $w_n(c_n(s), X)$ , having a length greater than 1, must necessarily contain a pair  $x_{j,b}^{-1}x_{j,b}$  associated to a surfel  $x_j$  and the  $b^{\text{th}}$   $n_{x_j}$ -connected component of  $G_n(x_j, X)$   $n$ -adjacent to  $x_j$ . Indeed, from the very definition of the word  $w_n(c_n(s), X)$ , no pair of the form  $x_{j,b}x_{j,b}^{-1}$  can occur in this word for any  $j \in \{0, \dots, l\}$ .

But, from Lemma 40, this implies that  $c_n(s)$  contains a surfel which is  $n$ -simple for  $X$ .  $\square$

**Definition 27 (border edgels associated with an element of  $\mathcal{C}_n^x[G_n(x, X)]$ )** Let  $x$  be an  $n$ -simple surfel of  $Z \subset \Sigma$ , and let  $C$  and  $D$  be the only elements of respectively  $\mathcal{C}_n^x[G_n(x, Z)]$  and  $\mathcal{C}_n^x[G_n(x, \bar{Z})]$  (see Definition 4 and Remark 2). The two edgels of the form  $(a, b)$  and  $(a', b')$ , where  $\{a, a'\} \subset C$  and  $\{b, b'\} \subset D$ , are called the two border edgels associated to the component  $C$  (see Figure 13).



(a) For  $(n, \bar{n}) = (e, v)$

(b)  $(n, \bar{n}) = (e, v)$  or  $(v, e)$

(c)  $(n, \bar{n}) = (v, e)$

Fig. 13. Border edgels associated with an  $n_x$ -connected component of  $G_n(x, X)$ .

**Lemma 42** Let  $x$  be a surfel of  $c_n(s)$  which is  $n$ -simple for  $Y$ . Let  $f$  and  $f'$  be the two border edgels associated with the unique connected component  $N_0$  of  $G_n(x, Y)$ . Let  $s'$  be a parameterized border of  $Y \setminus \{x\}$  which contains the two border edgels  $f$  and  $f'$  and such

that  $c_n(s')$  is a path from  $x'$  to  $x'$  where  $x' \neq x$ . Then the surfel path  $c_n(s')$  is reducible in  $Y \setminus \{x\}$ .

**Sketch of proof:** First,  $c_n(s)^*$  must have more than one surfel since  $x$  is simple. It follows that it is possible to find an edgel path  $s_2$  such that  $c_n(s)$  and  $c_n(s_2)$  are the same up to a cyclic permutation but the extremity of  $c_n(s_2)$  is different from  $x$ . Now, it is readily seen that if  $c_n(s)$  is reducible, then  $c_n(s_2)$  is reducible too.

Now, let  $s'$  be the  $s$ -path obtained by removing in  $s_2$  the edgels between  $f$  and  $f'$  which contain  $x$  (maybe such edgels do not exist as in the case of Figure 13(a)) and possibly replacing them with edgels of the form  $(x, q)$  where  $q$  belongs to  $N_0$ . If  $f = (b, d)$  and  $f' = (b', d')$  then let  $\gamma$  be the sub-path of  $c_n(s_2)$  from  $b$  to  $b'$  associated with the  $s$ -path from  $f$  to  $f'$  in  $s_2$ , and let  $\gamma'$  be the sub-path from  $b$  to  $b'$  of  $c_n(s')$  associated with the  $s$ -path from  $f$  to  $f'$  in  $s'$ . These two paths have the same extremities and are included in  $C \cup \{x\}$  where  $C$  is the only  $n_x$ -connected component of  $\mathcal{C}_n^x[G_n(x, Y)]$ . Then, it is easily seen that  $\gamma$  is  $n$ -homotopic to  $\gamma'$  in  $Y$ , so that the paths  $c_n(s_2)$  and  $c_n(s')$  are  $n$ -homotopic too. It follows that  $c_n(s_2)$  is reducible in  $Y$ .  $\square$

**Proof of Proposition 39:** We show the existence of a sequence of deletion of  $n$ -simple surfels which leads to  $\{y\}$  from  $Y$  where  $y$  is a surfel of  $Y$ .

Let  $s^0 = ((a, x_0), (b, x_0), (c, x_0), (d, x_0))$  be the  $s$ -curve of Proposition 39 and we set  $Y^0 = Y$ . Now, if  $m \geq 0$  and if  $s^m$  is a parameterized border of a set  $Y^m$  with at least 2 surfels such that  $c_n(s^m)$  is  $n$ -homotopic to the trivial path in  $Y^m$ , then, Lemma 40 shows that  $c_n(s^m)$  contains an  $n$ -simple surfel for  $Y^m$  which we denote by  $y^m$ . So, let  $N_0^m$  be the connected component of  $G_n(y^m, Y^m)$   $n$ -adjacent to  $y^m$  and let  $f$  and  $f'$  be the two border edgels associated with  $N_0^m$ . Then, let  $Y^{m+1} = Y^m \setminus \{y^m\}$  and  $s^{m+1}$  be the parameterized border of  $Y^{m+1}$  which contains the two border edgels  $f$  and  $f'$  as defined in Lemma 42, and let  $b^{m+1}$  be the basepoint of  $c_n(s^{m+1})$  (distinct from  $y^m$  following Lemma 42).

From Lemma 42, the path  $c_n(s^m)$  is  $n$ -homotopic to  $c_n(s^{m+1})$  in  $Y^m$  and  $c_n(s^{m+1})$  is reducible in  $Y^m$ .

Now, let  $i_*^m : \Pi_1^n(Y^{m+1}, b^{m+1}) \longrightarrow \Pi_1^n(Y^m, b^{m+1})$  be the morphism induced by the inclusion of  $Y^{m+1}$  in  $Y^m$ . Since  $y^m$  is  $n$ -simple for  $Y$ , Lemma 28 implies that the morphism  $i_*^m$  is a group isomorphism, in particular  $i_*^m$  is one to one.

Then,  $i_*^m([c_n(s^{m+1})]_{\Pi_1^n(Y^{m+1}, b^{m+1})}) = [c_n(s^{m+1})]_{\Pi_1^n(Y^m, b^{m+1})}$  but since the path  $c_n(s^{m+1})$  is  $n$ -reducible in  $Y^m$ , it follows that  $i_*^m([c_n(s^{m+1})]_{\Pi_1^n(Y^{m+1}, b^{m+1})}) = [1]_{\Pi_1^n(Y^m, b^{m+1})}$ . On the other hand, we have  $i_*^m([1]_{\Pi_1^n(Y^{m+1}, b^{m+1})}) = [1]_{\Pi_1^n(Y^m, b^{m+1})}$ . Then, since  $i_*^m$  is one to one we obtain that  $[1]_{\Pi_1^n(Y^{m+1}, b^{m+1})} = [c_n(s^{m+1})]_{\Pi_1^n(Y^{m+1}, b^{m+1})}$ . In other words, the  $n$ -path  $c_n(s^{m+1})$  is reducible in  $Y^{m+1}$ , so  $Y^{m+1}$  and  $s^{m+1}$  still satisfy conditions of Lemma 40.

By induction on the integer  $m$  we prove that while the set  $Y^m$  has more than two surfels, we can find a surfel  $y^m \in Y^m$  which is  $n$ -simple for  $Y^m$  and so a set  $Y^{m+1} = Y^m \setminus \{y^m\}$  which is lower  $n$ -homotopic to  $Y^m$  and strictly included in  $Y^m$ . Finally, there must exist an integer  $k$  such that  $Y^k$  is reduced to a single surfel  $\{y\}$ . It is clear from its construction that  $Y^k = \{y\}$  is lower  $n$ -homotopic to  $Y^0 = Y$ , so that  $Y$  is a topological disk.  $\square$

## 7 Proof of Theorem 5

### Proof of Theorem 5:

We use Theorem 4 and prove that Condition 2 is implied by Condition 1 except in a very particular case. So, we suppose that Condition 1 is satisfied and that there exists a  $\bar{n}$ -connected component  $A$  of  $\bar{Y}$  which is included in  $X$  (i.e.  $A$  contains no surfel of  $\bar{X}$ ). From Lemma 31 there exists a surfel  $x_0$  in  $A$  such that  $Y$  is lower  $n$ -homotopic to  $Y \cup (A \setminus \{x_0\})$ . Then, since  $i_*$  and  $i''_* : \Pi_1^n(Y, B) \rightarrow \Pi_1^n(Y \cup (A \setminus \{x_0\}), B)$  are isomorphisms for all  $B \in Y$ , the group morphism  $i'_* : \Pi_1^n(Y \cup (A \setminus \{x_0\}), B) \rightarrow \Pi_1^n(X, B)$  induced by the inclusion map  $i' : Y \cup (A \setminus \{x_0\}) \rightarrow X$  satisfying  $i_* = i'_* \circ i''_*$  is an isomorphism. Since  $x_0$  belongs to the  $\bar{n}$ -connected component  $A$  of  $\bar{Y}$ , the surfel  $x_0$  is an  $\bar{n}$ -isolated surfel of  $\overline{Y \cup (A \setminus \{x_0\})}$  and let  $s$  be a parameterization of the border between  $Y \cup (A \setminus \{x_0\})$  and  $\{x_0\}$ . Let  $c_n(s)$  be the  $n$ -path associated with the  $s$ -path  $s$ .

First, we suppose that  $c_n(s)$  is not reducible in  $Y \cup (A \setminus \{x_0\})$ . It is clear that the same path  $c_n(s)$  is reducible in  $Y \cup A$  and so in  $X$ . Thus, let  $z_0$  be the base surfel of  $c_n(s)$  and  $j_*$  be the morphism from  $\Pi_1^n(Y \cup (A \setminus \{x_0\}), z_0)$  to  $\Pi_1^n(X, z_0)$  induced by the inclusion of  $Y \cup (A \setminus \{x_0\})$  in  $X$ . Then,  $j_*$  cannot be one to one and from Lemma 30 the morphism  $i'_*$  cannot be an isomorphism since  $B$  and  $z_0$  are  $n$ -connected in  $Y \cup (A \setminus \{x_0\})$ . It follows that  $i_*$  is not an isomorphism and we get a contradiction.

Therefore  $c_n(s)$  is  $n$ -homotopic to the path reduced to a single surfel in  $Y \cup (A \setminus \{x_0\})$ . Then, by Proposition 39 we know that  $Y \cup (A \setminus \{x_0\})$  is a topological disk. From Lemma 31,  $Y$  is lower  $n$ -homotopic to  $Y \cup (A \setminus \{x_0\})$  so we have  $\chi_n(Y) = \chi_n(Y \cup (A \setminus \{x_0\})) = 1$ . Since  $Y \neq \Sigma$ , the set  $Y$  is a topological disk (Definition 19). Condition 2 of Lemma 29 shows that  $\bar{Y}$  has a single  $\bar{n}$ -connected component so  $\bar{Y} = A$ . From Lemma 31 it is straightforward that  $\{x_0\}$  is lower  $\bar{n}$ -homotopic to  $A$ , so that  $A$  is a topological disk. Then,  $Y \cup A = \Sigma$  and  $Y \cup A \subset X \subset \Sigma$  so  $X = \Sigma$ . Since  $\chi_n(Y) = 1$  and  $\chi_{\bar{n}}(\bar{Y}) = \chi_n(A) = 1$ , then  $\chi_n(\Sigma) = \chi_n(Y) + \chi_{\bar{n}}(\bar{Y}) = 2$ . This ends to prove that Condition 1 of Theorem 4 is implied by Condition 2 of Theorem 4 except in the particular case when  $X$  is the whole surface  $\Sigma$  which is a sphere and  $\bar{Y}$  is a topological disk as well as  $Y$ . And we obtain Theorem 5.  $\square$

### Conclusion

The intersection number, which was initially used in order to prove a basic Jordan theorem for digital curves lying on a digital surface (see [FM99]), has been used here among other tools to prove that the fundamental group can be used to completely characterize homotopy between subsets of a digital surface. Thus, the intersection number appears as a good tool for proving theorems of topology within digital surfaces.

Now, we have achieved to show that topology preservation within digital surfaces is strictly related to properties involving fundamental groups of objects. The framework of digital surfaces appears as an intermediate framework for digital topology between the



2D and 3D digital spaces. However, characterizing the homotopy between subsets of  $\mathbb{Z}^3$  is still a difficult and open problem. Indeed, the digital fundamental group is not sufficient in this case. Further works should investigate this open problem.

## References

- [Ber94] G. Bertrand. Simple points, topological numbers and geodesic neighborhoods in cubics grids. *Patterns Recognition Letters*, 15:1003–1011, 1994.
- [FM] S. Fourey and R. Malgouyres. Intersection number and topology preservation within digital surfaces. *Theoretical Computer Science*. Submitted for publication.
- [FM99] S. Fourey and R. Malgouyres. Intersection number of paths lying on a digital surface and a new jordan theorem. In *Proceedings of the 8th International Conference Discrete Geometry for Computer Imagery (DGCI'99)*, volume 1568 of *Lecture Notes in Computer Science*, pages 104–117. Springer, March 1999. Marne la Vallée, France.
- [Kon88] T. Yung Kong. Polyhedral analogs of locally finite topological spaces. *R. M. Shortt editor, General Topology and Applications: Proceedings of the 188 Northeast Conference, Middletown, CT (USA), Lecture Notes in Pure and Applied Mathematics*, 123:153–164, 1988.
- [Kon89] T. Yung Kong. A digital fundamental group. *Computer Graphics*, 13:159–166, 1989.
- [Kon95] T. Yung Kong. On topology preservation in 2-d and 3-d thinning. *International Journal of Pattern Recognition and Artificial Intelligence*, 9(5):813–844, 1995.
- [ML98] R. Malgouyres and A. Lenoir. Topology preservation within digital surfaces. *Computer Graphics and Image processing, Machine Graphics & Vision*, 7(1/2):417–426, May 1998. Varsow.
- [RKW91] Azriel Rosenfeld, T. Yung Kong, and A. Y. Wu. Digital surfaces. *CVGIP: Graphical Models and Image Processing*, 53(4):305–312, 1991.
- [RN97] Azriel Rosenfeld and A. Nakamura. Local deformation of digital curves. *Pattern Recognition Letters*, 18:613–620, 1997.
- [Udu94] J. K. Udupa. Multidimensional digital boundaries. *CVGIP: Graphical Models and Image Processing*, 56:311–323, 1994.