



HAL
open science

A UT/LS ozone climatology of the nineteen seventies deduced from the GASP aircraft measurement program

C. Schnadt Poberaj, J. Staehelin, D. Brunner, V. Thouret, V. Mohnen

► To cite this version:

C. Schnadt Poberaj, J. Staehelin, D. Brunner, V. Thouret, V. Mohnen. A UT/LS ozone climatology of the nineteen seventies deduced from the GASP aircraft measurement program. Atmospheric Chemistry and Physics Discussions, 2007, 7 (2), pp.3451-3517. hal-00328051

HAL Id: hal-00328051

<https://hal.science/hal-00328051>

Submitted on 18 Jun 2008

HAL is a multi-disciplinary open access archive for the deposit and dissemination of scientific research documents, whether they are published or not. The documents may come from teaching and research institutions in France or abroad, or from public or private research centers.

L'archive ouverte pluridisciplinaire **HAL**, est destinée au dépôt et à la diffusion de documents scientifiques de niveau recherche, publiés ou non, émanant des établissements d'enseignement et de recherche français ou étrangers, des laboratoires publics ou privés.

**GASP ozone
climatology of the
nineteen seventies**

C. Schnadt Poberaj et al.

A UT/LS ozone climatology of the nineteen seventies deduced from the GASP aircraft measurement program

C. Schnadt Poberaj¹, J. Staehelin¹, D. Brunner², V. Thouret³, and V. Mohnen⁴

¹Institute for Atmospheric and Climate Science, ETH Zürich, Switzerland

²Laboratory for Air Pollution/Environmental Technology, Empa, Dübendorf, Switzerland

³Laboratoire d'Aérologie, UMR 5560, Université Paul Sabatier, Toulouse, France

⁴Atmospheric Sciences Research Center, State University of New York at Albany, Albany, New York, USA

Received: 17 January 2007 – Accepted: 19 February 2007 – Published: 6 March 2007

Correspondence to: C. Schnadt Poberaj (christina.schnadt@env.ethz.ch)

Title Page

Abstract

Introduction

Conclusions

References

Tables

Figures

◀

▶

◀

▶

Back

Close

Full Screen / Esc

Printer-friendly Version

Interactive Discussion

Abstract

The knowledge of historical ozone in the upper troposphere/lower stratosphere (UT/LS) region is mostly confined to regular measurements from a number of ozonesonde stations. We present ozone measurements of the Global Atmospheric Sampling Program (GASP) performed from four commercial and one research aircraft during 1975 to 1979. Using GASP data, a UT/LS ozone climatology of 1975–1979 was built. Seasonality and concentrations of GASP UT ozone in the middle, subtropical and tropical regions of the northern hemisphere (NH) are generally in agreement with other published observations, derived from ozonesondes or aircraft campaigns. In regions where both GASP (1970s) and MOZAIC (1990s) data are available, similar ozone concentrations are found and seasonal cycles agree well confirming the reliability of GASP ozone. GASP provides unique large-scale climatological information on UT/LS ozone above the NH Pacific region. Agreement is found with observations from individual ozonesonde sites and aircraft campaigns carried out over this region. Tropical UT ozone is seen to be lower near the dateline than further east, presumably related to uplift of ozone poor air within convection. Over the west coast of the United States, summer UT ozone is higher than over the adjacent Pacific, probably caused by air pollution over southern California in the 1970s. GASP offers an unprecedented opportunity to link to European, Canadian and U.S. American ozonesonde observations of the 1970s. For the quantitative comparison, an altitude offset was applied to the sonde data to account for the slow response time of the sensors. In the LS, the European and Canadian Brewer-Mast (BM) sensors then agree to $\pm 10\%$ with the GASP instruments in all seasons. In the UT, the European BM sondes record similar to slightly less average ozone than GASP, however, with large variability overlaid. Over the eastern United States, systematic positive deviations of the Wallops Island ECC sondes from GASP of $+20\%$ are found. The comparisons over Europe and the eastern United States corroborate earlier findings that the early ECC sensors may have measured 10 to 25% more ozone than the BM sensors. Our results further indicate that applying the correction

ACPD

7, 3451–3517, 2007

GASP ozone climatology of the nineteen seventies

C. Schnadt Poberaj et al.

Title Page

Abstract

Introduction

Conclusions

References

Tables

Figures

◀

▶

◀

▶

Back

Close

Full Screen / Esc

Printer-friendly Version

Interactive Discussion

EGU

factor to the 1970s BM ozonesondes is necessary to yield reliable ozone mixing ratios in the UT/LS.

1 Introduction

Ozone is one of the key trace constituents in the atmosphere. It absorbs solar ultra-violet (UV) radiation in the stratosphere protecting the Earth's surface from UV-B and UV-C radiation. In the troposphere, its photolysis leads to the production of the hydroxyl radical (OH), the most important oxidant of tropospheric chemistry. In addition, ozone absorbs infrared radiation making it an important greenhouse gas. Changes in stratospheric, UT/LS, and tropospheric ozone thus alter the radiative balance of the atmosphere leading to changes in surface temperature. Applying the same percentage ozone increase (10%) to different altitudes in a radiative-convective model, Forster and Shine (1997) showed that both lower stratospheric and tropospheric ozone changes significantly contribute to changes in surface temperature, the maximum contribution, however, is obtained for an ozone increase applied in the tropopause region. In recent years much attention has therefore been laid on a better understanding of UT/LS ozone and the chemical and dynamical processes that govern its concentration (WMO, 1998; IPCC, 2001).

Information on stratospheric ozone and its changes over time can be inferred from ground-based total ozone measurements that have been performed since the 1920s. Continuous, well-calibrated measurements have been carried out at an increasing number of stations within the global ozone network since the early 1960s, predominantly at northern hemispheric midlatitude sites (Staehelin et al., 2001). Since 1978, additional information can be obtained from quasi-global and almost continuous satellite measurements providing information on total ozone and the stratospheric profile. Moreover, measurements from regular ozonesondes have been recording profile information of the troposphere and the stratosphere below 30 km since the late 1960s. Early ozonesonde profiles, however, were recorded at only few stations in Europe (Uc-

GASP ozone climatology of the nineteen seventies

C. Schnadt Poberaj et al.

Title Page

Abstract

Introduction

Conclusions

References

Tables

Figures

◀

▶

◀

▶

Back

Close

Full Screen / Esc

Printer-friendly Version

Interactive Discussion

cle, Belgium; Payerne, Switzerland; Hohenpeissenberg, Germany), Canada (Resolute, Churchill, Edmonton, Goose Bay), and Japan (Tateno, Kagoshima, Sapporo). The density of the ozonesonde station network has been increasing since the 1980s, and today more than 100 stations exist worldwide (see World Ozone and Ultraviolet Radiation Data Centre (WOUDC), <http://www.woudc.org>). Still, ozonesonde measurements are unevenly distributed over the globe and are mostly confined to the continents. Moreover, ozonesondes were developed to measure stratospheric ozone. They were not designed for recording low tropospheric ozone concentrations. For this reason, the data quality of tropospheric ozonesonde measurements is difficult to assess, especially during the early periods of the 1960s and 1970s, where no comparative measurements have been available so far (Logan et al., 1999).

Much better spatial data coverage is available at cruising altitudes in the UT/LS through the Measurement of Ozone and Water Vapor by Airbus in Service Aircraft Program (MOZAIC) (Marengo et al., 1998.; Thouret et al., 1998a; Thouret et al., 2006) since 1994. Within MOZAIC, five commercial aircraft have been equipped with fully-automated instruments to measure ozone and water vapour during in-service flights. The aircraft measurements cover large parts of the tropical, subtropical and middle latitude parts of the northern hemisphere including North America, the North Atlantic, Europe, Africa, and increasingly Asia.

Unfortunately, there is much less information on tropospheric and UT/LS ozone available before the 1990s apart from the sonde measurements. Long-term changes are therefore difficult to assess for large parts of the globe. In this study, we will present a UT/LS ozone data set of the second part of the 1970s, from the Global Atmospheric Sampling Program (GASP) which provides an unprecedented possibility to obtain information on the large-scale climatological ozone distribution in the UT/LS in the nineteen seventies. Ozone measurements from the GASP project were carried out on flights of four commercial B-747 airliners and one research aircraft during the period 1975 to 1979. Ozone data were gathered over large parts of the subtropical and midlatitude northern hemisphere focussing on North America, the Pacific, and the Atlantic regions,

**GASP ozone
climatology of the
nineteen seventies**C. Schnadt Poberaj et al.

Title Page

Abstract

Introduction

Conclusions

References

Tables

Figures

◀

▶

◀

▶

Back

Close

Full Screen / Esc

Printer-friendly Version

Interactive Discussion

but also including some measurements over Europe, South and East Asia, and Australia. It should be especially emphasised that GASP provides large-scale coverage of data above the Pacific Ocean, a region for which a representative data set of the ozone content in the UT/LS has been missing so far.

5 The present paper focuses on the ozone climatology obtained from the GASP data set, and the comparison with early balloon measurements. To compare GASP data in terms of seasonal cycle and order of magnitude of ozone concentrations, the derived climatology is also compared with MOZAIC measurements. In a forthcoming companion paper, long-term changes between the late nineteen seventies and nine-
10 teen nineties deduced from the GASP and MOZAIC data sets will be presented and discussed in comparison with respective changes obtained from ozonesonde measurements.

In Sect. 2, the data sets used and the applied methodology are described. Sect. 3 presents the GASP ozone climatology: vertical profiles, seasonality of upper tropo-
15 spheric ozone in specific regions of the northern hemisphere, and a specific climatology over the Pacific will be discussed. Careful analysis of the quality of the GASP data is important for future studies using these data. For this reason, and as a concurrent quality verification of early ozonesondes, a comparison between GASP and early bal-
20 loon data from Europe, Canada, and the United States is presented and discussed in Sect. 4. Finally, Sect. 5 contains the summary and conclusions.

2 Data and Methodology

2.1 The Global Atmospheric Sampling Program (GASP)

From 1975 to 1979, the National Aeronautics and Space Administration (NASA) con-
25 ducted the Global Atmospheric Sampling Program (GASP). While a large number of NASA reports were written documenting the GASP program and presenting some aspects of UT/LS ozone (e.g., Falconer et al., 1978; Gauntner et al., 1977; Falconer

GASP ozone climatology of the nineteen seventies

C. Schnadt Poberaj et al.

Title Page

Abstract

Introduction

Conclusions

References

Tables

Figures

◀

▶

◀

▶

Back

Close

Full Screen / Esc

Printer-friendly Version

Interactive Discussion

and Pratt, 1979; Holdeman and Nastrom, 1981b; Falconer et al., 1983; available at <http://ntrs.nasa.gov/search.jsp>), only few results were published in refereed scientific journals (Falconer and Holdeman, 1976; Nastrom, 1977; Nastrom, 1979). None of these provided a comprehensive climatology of GASP ozone.

5 The purpose of this program was to develop an extensive database of in situ measurements from aircraft mounted instrumentation. Four in-service B-747 of United Airlines (1), Pan Am (2) and Qantas (1), as well as the NASA CV-990 research aircraft were equipped with automated instrument platforms to measure ozone, aerosols, condensation nuclei, water vapour, and carbon monoxide. Whereas the quality of the
10 condensation nuclei measurements was assessed questionable, the carbon monoxide data overlaid with instrument noise (Wozniak, 1997), GASP ozone was considered more reliable in the same study. For this reason, we focus on the ozone measurements and will, in the following sections, show that the data are indeed of high quality.

15 Data are available from March 1975 to June 1979 when the funding for the program was cut. Altogether, the GASP period contains an impressive number of 6149 measurement flights. Measurements were carried out in the middle and upper troposphere and the lower stratosphere at altitudes between 6 and 13.7 km. The program mostly covered the North Atlantic and Pacific Oceans, as well as the North American continent, but also to a lesser extent Europe (Fig. 1a). A smaller number of flights went to
20 destinations in India, Singapore, Australia, New Zealand, and also to Rio de Janeiro and Sao Paulo in South America. The altitude range of GASP measurements is given in Table 1: most of the data were sampled at the standard flight levels 197 hPa (15.9%), 217 hPa (20.9%), and 238 hPa (19.3%). For comparison Fig. 1b shows the coverage of flights from the MOZAIC program (note the different colour scaling) based from Europe, but with large areas of spatial overlap with GASP.
25

2.1.1 The GASP system and ozone monitor

The sample-collecting system consisted of two air-sampling inlets in a single strut mounted outside the aircraft near the nose. One inlet was designed for near-isokinetic

GASP ozone climatology of the nineteen seventies

C. Schnadt Poberaj et al.

Title Page

Abstract

Introduction

Conclusions

References

Tables

Figures

◀

▶

◀

▶

Back

Close

Full Screen / Esc

Printer-friendly Version

Interactive Discussion

sampling used for particle measurements, the other inlet served to measure trace gases. To achieve the desired measurement sensitivity, the air sample from the second inlet was pressurized with a diaphragm pump with a pressure regulator controlling the inlet pressure to the instruments to 0.99 ± 0.02 atm.

A detailed description of the GASP ozone instrument is given by Tiefermann (1979). Only its main features will be summarised here. The instrument was a commercially available ultraviolet (UV) photometer manufactured by Dasibi Environmental Corporation. To meet airline safety standards and environmental requirements and to allow automated operation, the instrument was specially modified by Dasibi. The measurement principle was based on the absorption of UV light by ozone at 253.7 nm, a technique which is still standard in today's ozone monitors (e.g., Thouret et al., 1998b; Dias-Lalcaca et al., 1998; Klausen et al., 2003). The amount of light transmitted through the sample is expressed by the Lambert-Beer Law:

$$I/I_0 = \exp[-273CP\alpha L/(T \cdot 10^9)] \quad (1)$$

I/I_0 represents the transmittance of the sample, C the ozone volume mixing ratio (ppbv), P the sample-gas pressure (atm), α the ozone absorption coefficient at 253.7 nm at $T=273$ K and $P=1$ atmosphere ($308.5 \text{ cm}^{-1} \text{ atm}^{-1}$), L the path length (71 cm), and T the sample-gas temperature (K). Ozone concentrations were derived by alternately exposing sample gas and ozone-free zero gas in the absorption chamber to an ultraviolet beam at 253.7 nm and determining the difference in intensity. Note that the value for the absorption coefficient utilised in the GASP program is the standard value according to Hearn (1961), which is still used today including the MOZAIC program (personal communication, P. Nédélec).

A block diagram of the ozone monitor is shown in Fig. 2. The monitor consisted of three main parts: the light source and detectors, the absorption chamber, and the electronics. The light source was a low-pressure mercury lamp which mostly (90%) emits at 253.7 nm. Additional emission lines at 184.9 nm and 193.6 nm were eliminated with a filter. The UV light intensity was detected by two photodiodes, one of which

GASP ozone climatology of the nineteen seventies

C. Schnadt Poberaj et al.

Title Page

Abstract

Introduction

Conclusions

References

Tables

Figures

◀

▶

◀

▶

Back

Close

Full Screen / Esc

Printer-friendly Version

Interactive Discussion

served as control detector and the other one as sample detector, after the light passed through the absorption chamber. The output of the detectors was converted into pulses by two digital electrometers, the pulse rates being proportional to the light intensity. The electronics consisted of two pulse counters capable of counting up and down, the output circuit (shift register), and logic circuits that controlled the instrument operation.

A basic 60-min sampling cycle of the GASP system was constructed by alternating 5-min air-sampling periods and 5-min instrument control periods yielding six measurements per hour and six instrument control mode outputs taken each cycle. Due to limitations in data storage capacity, the data were only recorded during a 20 s interval at the end of each five minute air-sampling or control period and averaged over the last 5 s (see below). For the ozone instrument, two of the control periods were additionally used for air-sampling such that eight data records were taken per hour. Assuming the speed of a Boeing 747 to be about 900 km/h at cruise altitudes, this results in in-situ observations made at approximately every 110 km.

The 20 s measurement cycles were performed as follows: during the first 10 s, the sample gas was first directed through a valve to an ozone scrubber that destroyed all ozone and generated a zero gas. After a 5 s flush of zero-gas flow to the absorption chamber, situated behind the scrubber chamber, the sample and the control counter started counting pulses generated by the two electrometers. The sample counter counted up to the span, a preset number, and then stopped the control counter. After 10 s, the valve to the scrubber was deactivated, and the ozone sample was directly allowed in the absorption chamber. After another 5 s flush, the two counters counted down. The control counter counted down to zero and stopped the sample counter. Due to absorption by ozone, the pulse rate output from the sample electrometer was decreased such that a residual count was left in the sample counter. Provided a proper span, the residual output numerically equalled the ozone concentration in ppbv.

The ozone instrument had a measurement range of 3 to 1000 ppbv. Ozone loss upstream of the monitor due to temperature rise of the sample gas in the pump and contamination in the sample flow line and pump was determined using an ozone-

**GASP ozone
climatology of the
nineteen seventies**

C. Schnadt Poberaj et al.

Title Page

Abstract

Introduction

Conclusions

References

Tables

Figures

◀

▶

◀

▶

Back

Close

Full Screen / Esc

Printer-friendly Version

Interactive Discussion

destruction test package developed at the NASA Lewis Research Center in Cleveland, Ohio. Ozone loss was found to amount to around 16% in regular ozone destruction tests. The GASP data were corrected for this loss.

Before installation into GASP systems, all ozone monitors were calibrated against a Dasibi transfer standard (model 1003-AH), which was initially calibrated using the potassium iodide (KI) method. Later in the GASP program, due to uncertainties concerning accuracy and reproducibility of the KI method, the transfer standard was calibrated at the Jet Propulsion Laboratory (JPL) against a UV photometry standard. There, it was found that the GASP data had a 9% high bias relative to the JPL standard (Tiefermann, 1979). According to Tiefermann, the archived data were not corrected for this discrepancy. In addition to this systematic error, the total random error of any reading between 300 and 1200 ppbv was estimated to be about $\pm 3\%$ or $\pm 8\%$ depending on if the material used in the pump diaphragm was silicone or Buna-N, respectively. Below 300 ppbv, the random error for a single reading is ± 3 ppbv. For very low ozone concentrations, the total random error approaches 3 ppbv.

2.1.2 Pre-processing of the GASP data set

Before using the GASP ozone data for climatological and trend analysis, a thorough check of data quality was carried out. Three major issues were found which were necessary to be treated before using the data:

- The high bias of 9% described above was corrected for.
- Although the ozone data were supposed to have a temporal resolution of five to ten minutes (cf. Sect. 2.1.1), sometimes up to 16 samples per minute were recorded. These high temporal resolution data were encountered frequently during all five GASP years and for all aircraft. Indeed, there are specific months, i.e. October 1977 and October 1978 through March 1979, where a large part of the data was stored at high time resolution. October 1977 refers to the month where four across-pole flights of the N533PA Pan Am aircraft were undertaken within the

GASP ozone climatology of the nineteen seventies

C. Schnadt Poberaj et al.

Title Page

Abstract

Introduction

Conclusions

References

Tables

Figures

◀

▶

◀

▶

Back

Close

Full Screen / Esc

Printer-friendly Version

Interactive Discussion

**GASP ozone
climatology of the
nineteen seventies**

C. Schnadt Poberaj et al.

Title Page

Abstract

Introduction

Conclusions

References

Tables

Figures

◀

▶

◀

▶

Back

Close

Full Screen / Esc

Printer-friendly Version

Interactive Discussion

scope of the Pan Am Fiftieth Anniversary (Holdeman et al., 1978). The high temporal resolution data were recorded on purpose to document these special flights. The increased time resolution between October 1978 and March 1979 was introduced in conjunction with an activity to measure passenger exposure to cabin air ozone in commercial airliners (Holdeman and Nastrom, 1981a). Obviously, the GASP instrument could be switched to high time resolution when necessary, i.e. whenever the aircraft encountered high ambient ozone concentrations. During these events, the cabin ozone analyser was synchronized with the ambient air instrument. To detect peak passenger exposure, high time resolution was required. Although the high temporal resolution flights would be interesting to investigate, e.g. for case studies, using them in a climatological averaging process, however, would lead to false results. Thus, for the purpose of this study, one minute averages were computed for those times where a specific aircraft had more than one measurement recorded in a minute. Subsequently, one-minute average values were only considered in at least five minute intervals. As a result of this procedure, the original data set was reduced by 53%. This large number is due to the large reduction in observations during the “special observing periods”. When not considering October 1977 and October 1978 through March 1979, the data set only reduces by 18% indicating the typical reduction per month.

- As already noted by Wozniak (1997), there were obviously some erroneous readings within the large number of measurements that were not flagged in the routine data archival procedure (flagged data were not included in the analysis). This resulted in spuriously low ozone values on the order of some ppbv in the UT and values less than some tens of ppbv occurring in the LS. Using ozone probability density functions (not shown), suspicious data ranges were identified and removed prior to analysis: in the upper troposphere for mixing ratios less equal 10 ppbv and in the lower stratosphere if ozone values amounted to less than 30 ppbv. As a consequence of this procedure, another 3.7% of the five-minute data were considered not reliable and eliminated from the data set.

- Finally, tropospheric ozone values exceeding 150 ppbv were not considered in tropospheric analysis to prevent individual stratosphere-troposphere-exchange events becoming too important in some regional means computed from size-limited samples. This constraint increases the above given number of 3.7% reduction to 4.2%.

Considering all above issues and an additional minor reduction described in Sect. 2.4, the original data set, which contained 278 642 measurements, was reduced by 58% altogether, leaving little more than 115 000 records or little less than 14 700 flight hours.

2.2 Ozonesonde data

Ozone profile data from light balloon ascents from the period of 1975 to 1979 have been used for comparison. The data have been obtained from the World Ozone and Ultraviolet Radiation Data Centre (WOUDC) (<http://www.woudc.org>). As mentioned earlier, only few stations in Europe, Canada, the United States, and Japan do provide data records going back to the 1970s. For this study, only the European and the Canadian stations, as well as the US American station Wallops Island, which provide a sufficient number of ascents are considered. An overview of these stations, the number of ascents, and sensor type used is given in Table 2. The Japanese stations are excluded as the number of ascents during 1975–1979 is very small (25 at Sapporo, 30 at Tateno, and 20 at Kagoshima). As is evident from Table 2, Brewer-Mast sensors (BM, Brewer and Milford, 1960) were used at most stations. It should be noted that the Uccle balloon data, stored at WOUDC, are provided in homogenised form. The homogenisation was accomplished to account for changes in the procedures of handling the sensors during more than 30 years of observations. A report on the homogenisation procedure can be downloaded from <http://www.meteo.be/ozon/ozone/instrumental\research.php> (De Backer, 1999). At the U.S. Wallops Island station, Electrochemical Concentration Cell (ECC, Komhyr, 1969; 1971) ozone sensors were flown.

The BM sonde data used in this study have been corrected by linear scaling with

Title Page

Abstract

Introduction

Conclusions

References

Tables

Figures

◀

▶

◀

▶

Back

Close

Full Screen / Esc

Printer-friendly Version

Interactive Discussion

**GASP ozone
climatology of the
nineteen seventies**

C. Schnadt Poberaj et al.

[Title Page](#)[Abstract](#)[Introduction](#)[Conclusions](#)[References](#)[Tables](#)[Figures](#)[◀](#)[▶](#)[◀](#)[▶](#)[Back](#)[Close](#)[Full Screen / Esc](#)[Printer-friendly Version](#)[Interactive Discussion](#)

column ozone measurements, as proposed by the WMO standard procedure for BM sondes. The correction factor (CF), which represents the correction applied when comparing the ozone column obtained from integration of the recorded profile and a simultaneous ozone column measurement using a Dobson spectrometer, was then used as quality check. The range of allowed CF has been chosen according to Logan (1994): BM soundings were only included if the correction factor was in the range of 0.9–1.35. This corresponded to 67–89% of the ascents included, depending on the station. A narrower range, 0.9–1.2, was applied to data from the Meteorological Observatory of Hohenpeissenberg (MOHP), as this already included more than 90% of the data.

It may be interesting to know that as a result of the homogenisation of the Uccle time series, altitude dependent correction factors were derived comprising all effects accounted for in the homogenisation procedure. Whereas the average original Dobson normalisation CF amounted to 1.23 for the period 1975–1979, the homogenised Uccle data are much less corrected by a factor of 1.02 for the considered altitude range of 400 to 175 hPa and the same period of time (see below).

The ECC ascents at Wallops Island archived in WOUDC were Dobson normalized for the period 1970–1985. However, during this period there were some ascents for which normalisation was not possible as Dobson total ozone measurements were not available.

For the purposes of this study, the data were thus reprocessed: the normalisation was removed where it was used (159 out of 188 ascents). Those data were then renormalised using alternative correction factors, that are consistent for the whole 1970–2004 Wallops Island record (personnel communication, S. Oltmans). This was achieved by using SBUV climatological profiles for the ozone residual at altitudes above 7 hPa or the top of the sounding, if it reached 30 hPa (for SBUV climatology, see McPeters et al., 1997). In addition, 14 out of 29 non-normalised ascents available at WOUDC were normalised using corrections factors provided by S. Oltmans. The remaining ascents were treated as having an ideal CF of 1. This is an acceptable simplification since the average CF of the normalised data is very near to unity (0.99).

Hence it can be assumed that the CFs of the non-normalised ascents do not significantly deviate from 1 either.

Finally, sounding data were only included in the analysis in the pressure range between 400 and 175 hPa, as this represents the predominant altitude range of aircraft (Table 1).

2.3 The Measurement of Ozone and Water Vapor by Airbus in Service Aircraft Program (MOZAIC)

Data from the Measurement of Ozone and Water Vapor by Airbus in Service Aircraft Program (MOZAIC) are used in this study to qualitatively check the upper tropospheric seasonal cycle of the GASP data in Sect. 3.2. MOZAIC was launched in January 1993. Detailed descriptions of the program and first results can be found in a special issue of the Journal of Geophysical Research from 1998 (Marenco et al., Helten et al., Cammas et al., Law et al., Thouret et al., 1998a; Thouret et al., 1998b). Five Airbus of Air France, Sabena, Lufthansa (2), and Austrian Airlines have been equipped with fully automated instruments to measure ozone and water vapour during in-service flights. Ozone and water vapour observations have been available since August 1994 onward. MOZAIC observations cover large parts of North America, Europe, Asia, and also Africa (Fig. 1b). Additionally, flight routes to destinations in Brazil and Chile are included giving some coverage over the tropical Atlantic Ocean and the Caribbean Sea, as well as the east and west coasts of South America. Note that unlike in the GASP campaign, MOZAIC aircraft measurements so far do not cover the Pacific Ocean region.

The ozone analyser is a dual beam UV absorption instrument with a detection limit of 2 ppbv and an overall precision of $\pm [2 \text{ ppbv} + 2\%]$. Measurements are taken every 4 s, starting after takeoff and continuing to landing. However, most data have been collected between 9 and 12 km (Table 1). The MOZAIC instrument is similar to the GASP instrument in many respects, including the basic measurements principle of absorption of UV light at 253.7 nm from a Mercury lamp, the use of a scrubber to generate zero

GASP ozone climatology of the nineteen seventies

C. Schnadt Poberaj et al.

Title Page

Abstract

Introduction

Conclusions

References

Tables

Figures

◀

▶

◀

▶

Back

Close

Full Screen / Esc

Printer-friendly Version

Interactive Discussion

air, and the pre-compression of the sample air using a diaphragm pump. In this study, the pre-processed one minute average data are used for the period of August 1994 through December 2001. Horizontally, the one minute averaging results in a record being representative of approximately 15 km flight path (assuming an average air speed of 900 km/h). Between August 1994 and December 2001, 14558 MOZAIC flights were carried out that consisted of 113008 flight hours altogether. The chosen period ending in December 2001 results from the availability of ECMWF 40-year reanalyses used in this study (cf. next section).

For consistency, the MOZAIC data were pre-processed in an analogous way as the GASP data eliminating all ozone readings below 10 ppbv and above 150 ppbv in the UT and below 30 ppbv in the LS (cf. Sect. 2.1.2). The processing resulted in a minor reduction of the data set of 0.6%.

2.4 Methodology

The GASP aircraft data mostly cover the region of the upper troposphere, the tropopause region, and the lowermost stratosphere. Whereas tropospheric ozone concentrations are relatively constant over altitude, they strongly increase in the lower stratosphere and are, thus, highly dependent on position with respect to the tropopause (e.g., Logan, 1999).

For this reason, the GASP and MOZAIC aircraft, and the balloon ozone data were arranged relative to the tropopause. To discriminate between tropospheric and stratospheric air masses, the dynamical tropopause was used because both ozone and the conservative tracer potential vorticity (PV) are characterized by strong vertical gradients in the tropopause region and in the lower stratosphere. Consequently, ozone and PV are typically observed to be positively correlated in these altitude regions (Danielsen, 1968; Beekmann et al., 1994). Seasonally compact relationships are also found between GASP ozone and PV from the 40 year ECMWF reanalyses (ERA40, Uppala et al., 2005), spatially and temporally interpolated onto the GASP flight tracks,

**GASP ozone
climatology of the
nineteen seventies**

C. Schnadt Poberaj et al.

Title Page

Abstract

Introduction

Conclusions

References

Tables

Figures

◀

▶

◀

▶

Back

Close

Full Screen / Esc

Printer-friendly Version

Interactive Discussion

shown for the latitude range between 10° N and 70° N in Table 3¹.

At subtropical to middle latitudes (>30° N), correlation coefficients are high ranging from 0.81 to 0.90 with an average value of 0.86 (30° N–60° N). The order of values is similar for MOZAIC data (not shown) and comparable to those found by Beekmann et al. (1994), who investigated balloon-borne data at Haute Provence in Southern France. In the tropics, aircraft cruising altitudes usually do not reach the tropopause. Whereas ozone mixing ratios vary between very low values less than 20 ppbv to approximately 100 ppbv in the tropical troposphere, PV values most often stay below 1 PVU such that it is not possible to establish a correlation. Assuming that the quality of the ERA40 reanalyses is not as good in the pre-satellite era, the high correlations found between GASP ozone and ERA40 PV may be surprising. However, GASP temperatures and winds were used in the assimilation of the ERA40 reanalyses (personnel communication, A. Simmons, J. Woollen) guaranteeing consistency between the dynamical subsidiary variables from ERA40 and GASP meteorological conditions. On the basis of these dynamical prerequisites, the tight ozone/PV relationship gives a first indication of the quality of the GASP ozone measurements.

Besides PV, tropopause pressure and potential temperature at the thermal and the dynamical tropopause, as well as temperature and potential temperature at cruise altitude were interpolated temporally and spatially from the ERA40 data set onto the GASP, MOZAIC, and ozone sounding coordinates. We use the 2 PVU dynamical tropopause to vertically bin all data, because it best coincides with the ozonopause (Zahn et al., 1999).

To guarantee that only reliable ERA40 information was used at any given time and place, aircraft measurements were only considered in the averaging process when aircraft and ERA40 temperatures deviated less than 3 K from each other. Applying this

¹Linear (nonlinear) correlation coefficients are used where mostly tropospheric (tropospheric and stratospheric) ozone data are available. Nonlinear correlation coefficients are based on correlating PV with the logarithm of ozone accounting for only slightly varying ozone mixing ratios in the UT and increasing ozone mixing ratios in the LS.

**GASP ozone
climatology of the
nineteen seventies**

C. Schnadt Poberaj et al.

Title Page

Abstract

Introduction

Conclusions

References

Tables

Figures

◀

▶

◀

▶

Back

Close

Full Screen / Esc

Printer-friendly Version

Interactive Discussion

constraint, 3.7% of the pre-processed GASP data (cf. Sect. 2.1.2) have not been used.

To compute vertical ozone profiles as presented in Sect. 3.1, the difference between the ERA40 potential temperatures at cruise altitude and at the 2 PVU tropopause was used to bin aircraft ozone data in layers of 10 K width around the dynamical tropopause covering a vertical range of -45 K to $+65\text{ K}$ ($\Delta\theta = -40\text{ K} \hat{=} [-45\text{ K}, -35\text{ K}]$, $-30\text{ K} \hat{=} [-35\text{ K}, -25\text{ K}]$, etc.). The upper tropospheric climatological ozone values presented in Sect. 3.2 were calculated averaging over all measurements below the 2 PVU tropopause ($\Delta\theta < 0\text{ K}$). For the analysis in the lower stratosphere, where diabatic processes only play a minor role and ozone is mostly dominated by large-scale transport, all data have additionally been arranged into the equivalent latitude/potential temperature framework. The main advantage of using this coordinate system is that much of the ozone variability in the longitudinal structure is removed such that computing quasi-zonal means at equivalent latitudes constitutes a meaningful diagnosis tool (e.g., Hegglin et al., 2006). After binning the aircraft and balloon ozone data vertically relative to the dynamical tropopause and computing quasi-zonal means, the data were finally averaged over specific equivalent latitude (EL) ranges. These EL ranges were on the one hand chosen according to the prevailing EL ranges of the chosen ozone soundings and, on the other hand, to represent middle and higher latitudes.

In the upper troposphere, the ozone distribution is connected to the geographical distribution of ozone precursor emissions. For the comparison with MOZAIC and ozonesonde observations in the UT, we have therefore calculated regional averages for specific regions listed in Table 4 (see also Fig. 4). Seasonal means were calculated to qualitatively compare mean annual cycles between GASP and MOZAIC in the selected regions. For the quantitative comparison with ozonesondes, however, quasi-monthly means were computed using only those dates in each month with concurrent measurements of a given sonde station.

**GASP ozone
climatology of the
nineteen seventies**

C. Schnadt Poberaj et al.

Title Page

Abstract

Introduction

Conclusions

References

Tables

Figures

◀

▶

◀

▶

Back

Close

Full Screen / Esc

Printer-friendly Version

Interactive Discussion

3 GASP climatology

3.1 Zonal mean profiles

Figure 3 presents climatological mean seasonal ozone profiles for specific latitude ranges for the upper troposphere (UT) and lower stratosphere (LS). In the UT, data are binned according to their geographical latitudes. In the LS, geographical latitudes were used for the range 20° N–40° N and equivalent latitudes for the bands 40° N–60° N and 60° N–80° N.

At all latitudes, vertical gradients are very small in the upper troposphere below –15 K (0.3–0.4 ppbv/K). In the uppermost troposphere (–10 K $\hat{=}$ –15 to –5 K), ozone already increases at 2.3 to 4.3 ppbv/K. Gradients in the lower stratosphere are largest ranging from 5 to 10 ppbv/K.

Due to the higher altitude of the tropopause at subtropical latitudes, less data were recorded in the stratosphere between 20° N and 40° N than at higher latitudes. For this reason, as well as due to fewer flights at these latitudes, the LS seasonal cycle is not completely described at altitudes above 40 K above the tropopause. The existing stratospheric data point to a similar seasonal cycle as at higher latitudes with highest values in springtime, lower values in winter and lowest in autumn.

The typical stratospheric seasonal cycle is also evident at middle and high latitudes (40° N–60° N EL and 60° N–80° N EL). During spring, average ozone values range from about 220 ppbv at 10 K above the tropopause to 615 ppbv (650 ppbv) at 60 K above the tropopause at middle latitudes (high latitudes). In autumn, ozone mixing ratios are much lower extending from 120 ppbv (150 ppbv) at 10 K above the tropopause to 320 ppbv (355 ppbv) at 60 K above the tropopause at midlatitudes (high latitudes).

In the upper subtropical troposphere, the seasonal cycle still has stratospheric characteristics with largest values in spring and smallest in autumn suggesting a marked stratospheric influence. At middle latitudes, average UT ozone mixing ratios are highest in summer ranging from 65 to 67 ppbv, whereas values are considerably lower

Title Page

Abstract

Introduction

Conclusions

References

Tables

Figures

◀

▶

◀

▶

Back

Close

Full Screen / Esc

Printer-friendly Version

Interactive Discussion

in winter (38–52 ppbv) and autumn (43–45 ppbv). The seasonality of UT ozone in the zonal mean is typical of midlatitudes, as will be discussed in more detail in the next section. At higher latitudes, due to the low altitude of the tropopause, most measurements were taken in the LS. Thus, the GASP data do not reveal insights into high latitude UT ozone.

3.2 Upper tropospheric ozone in different regions of the Northern Hemisphere

For further analysis of UT ozone measurements, we have computed regional averages for both GASP and MOZAIC data in those regions of the world, where both GASP and MOZAIC data are available (Fig. 4, Table 4). In specific cases such as over Northern Japan (N JP), this methodology results in large averaging boxes that are only partly representative of GASP or MOZAIC data coverage: whereas GASP flights approach Japan from the east, MOZAIC data cover the region west of Japan (Fig. 1). To obtain seasonal averages, arithmetic means and medians were computed using all seasonal data from the five-year period.

However, in individual regions the sample size is limited in some seasons and/or years. Thus, some averages may not be representative for the five GASP years, and designating these averages “climatology” may not be justified. In fact, most GASP measurements were recorded during 1978. For this reason, many of the computed averages are more or less biased toward this year. To document the availability of GASP data, the number of records available in each region is presented in Table A1 as function of season and year. Potential constraints of representativeness will be discussed for individual regions where necessary.

The seasonal variation of UT ozone in different regions is shown in Fig. 5. The MOZAIC means and medians are additionally displayed for comparison of the seasonal cycle in the GASP data. Over the western parts of the United States and the northern hemisphere Pacific Ocean, no MOZAIC averages were computed, because there are either only few (western United States) or no (Pacific Ocean) data available. The GASP data thus provide additional information on the seasonal cycle of UT ozone over the

GASP ozone climatology of the nineteen seventies

C. Schnadt Poberaj et al.

Title Page

Abstract

Introduction

Conclusions

References

Tables

Figures

◀

▶

◀

▶

Back

Close

Full Screen / Esc

Printer-friendly Version

Interactive Discussion

western United States, complementing ozonesonde measurements at Trinidad Head, California. To our knowledge, no other long-term aircraft measurements have been carried out over the midlatitude and subtropical Pacific Ocean. Hence, the GASP data yield very valuable new information on UT/LS ozone there. A more detailed discussion of GASP ozone over the northern hemispheric Pacific will be presented in Sect. 3.3.

It has been known for more than 30 years that tropospheric ozone concentrations and the seasonal cycle can be quite different in different regions of the world (e.g., Logan et al., 1999). Studies show that at middle latitudes of the northern hemisphere, upper tropospheric ozone concentrations are highest in summer and lowest in winter (e.g., Logan, 1994; Thouret et al., 1998a; Brunner et al., 2001) probably reflecting the influence of both photochemistry (maximum in summer) and stratosphere-troposphere exchange peaking in spring (e.g., Stohl et al., 2003). Here, ozone mixing ratios are relatively homogeneously distributed over altitude and over longitudes peaking at 70–80 ppbv in summer and being as low as 40–55 ppbv in winter (Thouret et al., 1998a).

The described features are also reflected in the GASP and MOZAIC middle latitude UT ozone data (Fig. 5). From Europe (EUR) over the Atlantic (ATL) to the northeastern part of the United States (NE USA), the typical midlatitude seasonal cycle evolves. During the nineteen seventies, mean summer values lie in the range of 70–80 ppbv over Europe, the Atlantic, and Northeastern USA, whereas winter concentrations cover the range between roughly 40 ppbv (ATL, NE USA) and 50 ppbv (EUR). The range of ozone concentrations derived from the GASP measurements agrees well with more recent observations from the 1995/96 NOXAR program (Brunner et al., 2001; their Plate 2). Interestingly, summer mixing ratios over these regions are higher in the 1970s than in the second half of the 1990s possibly pointing to larger photochemical ozone production in the earlier period.

Over the western parts of the United States (W USA), UT ozone exhibits a different seasonal cycle more similar to the cycle in the LS. This pattern does not change when restricting the latitude range to lower (30° N–40° N) or higher midlatitudes (40° N–50° N) (not shown). During spring, mean ozone mixing ratios (65±27 ppbv) are significantly

GASP ozone climatology of the nineteen seventies

C. Schnadt Poberaj et al.

Title Page

Abstract

Introduction

Conclusions

References

Tables

Figures

◀

▶

◀

▶

Back

Close

Full Screen / Esc

Printer-friendly Version

Interactive Discussion

higher than over the eastern US, the Atlantic, or Europe. In contrast, summer values are comparatively low (64 ± 26 ppbv) compared to mixing ratios over eastern US, Atlantic, and Europe of 76 ± 27 ppbv, 78 ± 28 ppbv, and 70 ± 26 ppbv, respectively.

The same type of seasonal cycle and similar values are also found above the eastern midlatitude and subtropical Northeast Pacific (ML NEP and ST NEP, respectively). A recent analysis by Newchurch et al. (2003) of ozonesonde data from four balloon stations across the United States, with one of them being Trinidad Head, California, (41.07° N, 124.15° W) over the period 1997-2002 is in agreement with the seasonality and concentrations observed by GASP over the western United States. Newchurch et al. (2003) find a spring maximum in middle and upper tropospheric ozone over Trinidad Head, while at the other three stations Boulder, Colorado, Huntsville, Alabama, and Wallops Island, Virginia, mixing ratios increase from spring to summer. Newchurch et al. relate the spring maximum in UT ozone at Trinidad Head to an enhanced frequency of stratosphere-troposphere exchange episodes and/or higher intensities of these events in terms of the amount of ozone exchanged compared to the other stations. They also observe higher UT ozone than at the other stations between January and July. These findings are corroborated by the results gained in the European STACCATO project, which investigated stratosphere-troposphere exchange (STE) (e.g., Stohl et al., 2003). There, using Lagrangian models, it could be shown that a preferred area of deep downward stratosphere-troposphere exchange is at the end of the Pacific stormtrack, located above the U.S. west coast, with STE maximising in winter. Moreover, the implications of STE for tropospheric ozone were also investigated in STACCATO showing that in the UT, maximum ozone concentrations resulted in the spring season (Stohl et al., 2003; their Fig. 5). Most probably, the lacking summer maximum in UT ozone over the Pacific is associated with clean air masses prevalent in this region. Over the western United States it indicates a major influence of air masses brought in from the Pacific on the seasonal cycle.

The seasonal cycle and ozone concentrations observed by GASP over the subtropical Northeast Pacific (ST NEP) agree well with UT ozonesonde measurements at Hilo,

**GASP ozone
climatology of the
nineteen seventies**C. Schnadt Poberaj et al.

[Title Page](#)[Abstract](#)[Introduction](#)[Conclusions](#)[References](#)[Tables](#)[Figures](#)[◀](#)[▶](#)[◀](#)[▶](#)[Back](#)[Close](#)[Full Screen / Esc](#)[Printer-friendly Version](#)[Interactive Discussion](#)

Hawaii (20° N, 155° W) for the period 1985–1990 (Oltmans et al., 1996; their Fig. 5, 300 hPa). There, ozonesonde mixing ratios amount to approximately 45±15 ppbv in January, 62±30 ppbv in April, 32±10 ppbv in July, and 32±15 ppbv in October. Over the ST NEP region, GASP UT ozone averages to 44±23 ppbv in DJF, 63±28 ppbv in MAM, 46±22 ppbv in JJA, and 35±18 ppbv in SON. The spring maximum was explained to be partly caused by long-range transport of Asian pollution leading to photochemical production of ozone (Oltmans et al., 1996; Wang et al., 1998; Liu et al., 2002). Other parts are likely to be associated with descending air motion and paths coming from north of 30° N contributing stratospheric air high in ozone (Oltmans et al., 1996).

Over midlatitude Northern Japan (N JP), GASP data are almost exclusively available from 1978 (Table A1). Hence, it has to be kept in mind that the computed averages may not be representative of longer-term means. Still, the seasonal evolution of GASP ozone is consistent with that of MOZAIC and values are comparable. Over midlatitude N JP and subtropical-midlatitude Southern Japan (S JP), differing types of seasonal cycles evolve in a consistent way for GASP and MOZAIC data. Whereas over N JP, high values of GASP ozone extend from spring (65±24 ppbv) to summer (66±24 ppbv), the seasonality over the southern parts is characterised by a spring maximum (68±26 ppbv) and much lower values in summer (55±24 ppbv) and autumn (50±22 ppbv). These features are in qualitative agreement with Japanese ozonesonde observations (Logan, 1985; 1999; Liu et al., 2002; Naja and Akimoto, 2004). Whereas at lower latitudes, e.g., at Naha (26° N) and Hongkong (22° N), the seasonal cycle exhibits a spring maximum and a summer minimum (Liu et al., 2002), the ozone maximum shifts to summer at Sapporo (43° N) (Logan, 1999). The observed low ozone values in summer at lower latitudes are associated with monsoonal intrusion of low-ozone air from the tropical Pacific. Toward more northern latitudes, the influence of the monsoon decreases, and the summer maximum at Sapporo is a result of increased photochemical production, typical of the northern midlatitudes.

Over northern India (N IND), southern India (S IND), and South China (S CHINA), GASP and MOZAIC data show springtime maxima. The only exception from this over-

GASP ozone climatology of the nineteen seventies

C. Schnadt Poberaj et al.

Title Page

Abstract

Introduction

Conclusions

References

Tables

Figures

◀

▶

◀

▶

Back

Close

Full Screen / Esc

Printer-friendly Version

Interactive Discussion

all pattern is over southern India for the GASP period, where no spring maximum is found. This might be due to the restricted number of measurements available (113), out of which almost 90% were recorded during 1977 (Table A1). UT spring maxima in the subtropical to tropical atmosphere as observed by the GASP and MOZAIC programs may in fact be a common phenomenon as there are further measurement programs and campaigns, which yielded similar results: High springtime middle to upper tropospheric ozone concentrations were also observed on the flight route between Bombay and Hong Kong during the Swiss 1995/96 NOXAR project (Brunner et al., 2001) and somewhat further south between 15° N and 20° S over the Indian Ocean during the 1998/1999 INDOEX campaigns (Zachariasse et al., 2000, 2001; De Laat, 2002). However, the origin of the spring maxima is still under debate: Zachariasse et al. (2000, 2001), using back trajectory analyses, hypothesized that the observed midtropospheric (500–300 hPa, app. 5–10 km) springtime ozone maxima over the Indian Ocean were caused by stratosphere-troposphere exchange in the vicinity of the subtropical jet stream followed by large-scale advection and descent. On the other hand, for the INDOEX campaign region, De Laat (2002) argued, on the basis of GCM simulations driven by meteorological analyses, that the major source of the INDOEX midtropospheric ozone maxima was advection of polluted air masses from continental biomass burning areas over Africa, with generally only a small contribution of stratospheric ozone.

Ozone mixing ratios over Northern India are comparable to those over Southern Japan in autumn (50 ± 19 ppbv) and winter (50 ± 18 ppbv), but they are somewhat lower in spring (52 ± 20 ppbv) and much lower during summer (41 ± 17 ppbv). Over southern India (5° N–20° N), UT ozone mixing ratios are generally very low ranging from 33–44 ppbv in winter and spring to 24 ± 8 ppbv (27 ± 11 ppbv) in summer (autumn) on average. The summer minimum observed over northern and southern India can be related to convective activity during the summer monsoon. During this time of the year, ground stations in India report the lowest NO_x and ozone concentrations (Naja and Lal, 1996, 2002; Kulshreshta et al., 1997). Intensive convective activity carries the

**GASP ozone
climatology of the
nineteen seventies**

C. Schnadt Poberaj et al.

Title Page

Abstract

Introduction

Conclusions

References

Tables

Figures

◀

▶

◀

▶

Back

Close

Full Screen / Esc

Printer-friendly Version

Interactive Discussion

NO_x and ozone poor air masses to the middle and upper troposphere. This notion is supported by NOXAR measurements, which show pronounced minima in nitrogen oxides and ozone at cruising levels in South East Asia in summer (Brunner et al., 2001). A summer minimum in UT ozone is not seen in the MOZAIC data over northern India.

5 This is most probably due to the fact that a large part of data collected by MOZAIC in the northern Indian region (cf. Table 4) were recorded in the northern part of the region not influenced by the Indian monsoon (not shown).

Over the South China region (S CHINA), GASP and MOZAIC measurements indicate that UT ozone concentrations vary only little between summer, autumn, and winter (32±20 ppbv, 33±15 ppbv, and 33±16 ppbv, respectively). As is also characteristic for the North and South Indian regions, UT ozone over South China also exhibits a spring-time maximum, which approximately amounts to 45 ppbv on average for both GASP and MOZAIC periods.

3.3 Upper tropospheric ozone in the Pacific region

15 Until now, most studies documenting the ozone content and seasonality of the northern hemisphere Pacific region have been confined to analyses of data from individual ozonesonde stations, that are mostly situated on the coasts confining the Pacific ocean (e.g., Logan et al., 1999; Oltmans et al., 2001; Liu et al., 2002; Oltmans et al., 2004). Moreover, evaluations of individual aircraft campaigns such as the Pacific Exploratory Mission-West A (PEM-West A) campaign in 1991 or the Transport and Chemical Evolution over the Pacific (TRACE-P) campaign in March/April 2001 (e.g., Singh et al., 1996; Zhang et al., 2003; Wild et al., 2003) give insight into UT/LS ozone in the Pacific area. In addition, using satellite data, the tropospheric ozone content over the Pacific Ocean has been estimated (e.g. Fishman et al., 2003). There has been one major effort to assemble chemical data including ozone from 10 aircraft campaigns in 20 years into a climatology for the central and eastern North Pacific region (DiNunno et al., 2003) providing important insights concerning the latitudinal and height dependencies of ozone, as well as its seasonality. However, the resulting climatology is based on individual

Title Page

Abstract

Introduction

Conclusions

References

Tables

Figures

◀

▶

◀

▶

Back

Close

Full Screen / Esc

Printer-friendly Version

Interactive Discussion

flights separated by large time intervals possibly not capturing the whole range of typical ozone concentrations. It is also confined to the spring and autumn seasons, the times when most campaigns were carried out.

Here we present averages from five years of regular GASP measurements that give a more comprehensive picture of the seasonality, horizontal distribution, and latitudinal dependence of UT ozone over the Pacific. During 1975 through 1979, little more than 1300 flights were carried out across the Pacific Ocean (10° N–50° N, 150° E–125° W). While data were recorded regularly during all five GASP years (Table A1), a significant fraction of the overall number of records was collected during 1978. For the winter and spring seasons, the fraction amounts to 30–45%, for the summer and autumn seasons to about 60–70%.

The GASP UT ozone distribution is presented in Fig. 6: Tropical ozone at latitudes < 20° N is relatively low, and a clear seasonal cycle is not discernible. Interestingly, in the spring and more so in the summer season, ozone at 170°W to 165°W, amounting to 20 to 24 ppbv, is approximately 5 to 15 ppbv lower than further east at 160° W–145° W, where values between 26 and 38 ppbv are found. In contrast, during boreal winter, no clear west-east differences are discernible. For the autumn season, GASP does not provide enough data to assess longitudinal variations.

In fact, these distributions, as well as their seasonal differences are in qualitative agreement with the tropospheric ozone residual (TOR) derived from the TOMS and SBUV instruments for the period 1979 to 2000 (Fishman et al., 2003, their Fig. 1). Obviously, the region of low tropospheric ozone columns and UT ozone coincides with the warm pool area and the Intertropical Convergence Zone (ITCZ) as can be nicely seen when comparing the tropospheric ozone column distribution in Fishman et al. with climatological sea surface temperatures (e.g., Reynolds and Smith, 1995). The lowest troposphere over the equatorial Pacific acts as a chemical ozone sink, in which low ozone concentrations result from photochemical destruction involving water vapour and solar ultraviolet radiation (e.g., Kley et al., 1997). Indeed, low ozone concentrations in the equatorial marine boundary layer have been reported already early in numerous

**GASP ozone
climatology of the
nineteen seventies**

C. Schnadt Poberaj et al.

Title Page

Abstract

Introduction

Conclusions

References

Tables

Figures

◀

▶

◀

▶

Back

Close

Full Screen / Esc

Printer-friendly Version

Interactive Discussion

studies (Liu et al., 1983; Piotrowicz et al., 1986, 1991; Johnson et al., 1990; Thompson et al., 1993). This ozone-poor air can be lifted upwards in tropical convection leading to low concentrations also in the UT (e.g., Kley, 1997). In the more eastern parts of the Pacific region, there is less convective activity. For this reason, it seems plausible that UT air masses are not as much affected by ozone-poor air from the marine boundary layer. Another mechanism possibly contributing to the higher tropical UT ozone concentrations over the eastern Pacific may be through large-scale advection of higher-ozone containing air masses from northern and central America that occurs in association with southward flow at the eastern flank of the UT high pressure centre over the Western Pacific (e.g., Gregory et al., 1999; DiNunno et al., 2003).

A further remarkable feature of the UT ozone distribution are elevated ozone levels over the west coast of the United States in spring (70–80 ppbv) and summer (60–90 ppbv), which are significantly higher than over the adjacent Pacific Ocean. There, ozone mixing ratios are at least 10 ppbv lower than over the American continent. The high mixing ratios over the continent can possibly be attributed to air pollution over southern California, a well-known phenomenon of the 1950s to 1970s (e.g., Grosjean, 2003).

Finally, the latitudinal dependence of UT ozone over the Northeast Pacific was investigated for a meridional cross section at 150° W to 130° W as a function of season (Fig. 7). It can clearly be seen that tropical ozone mixing ratios are much lower than subtropical and midlatitude values during all seasons. In the tropics ($\phi < 20^\circ$ N), UT ozone varies between 20 to 25 ppbv in autumn and 30 to 40 ppbv in spring, whereas subtropical values (20° N $< \phi < 30^\circ$ N) can be as low as 35 to 40 ppbv in autumn and as high as 65 to 70 ppbv in spring. The seasonal cycle at tropical to subtropical latitudes is characterized by largest values in spring, comparable mixing ratios in summer and winter, and lowest in autumn (cf. also Sect. 3.2). A plausible explanation for the high springtime mixing ratios at subtropical latitudes could be cross-tropopause transport from the LS into the UT in the subtropical jetstream area (Stohl et al., 2003, their Figs. 3a and 5). The latitude zone between 30° N and 40° N can be considered a tran-

**GASP ozone
climatology of the
nineteen seventies**

C. Schnadt Poberaj et al.

Title Page

Abstract

Introduction

Conclusions

References

Tables

Figures

◀

▶

◀

▶

Back

Close

Full Screen / Esc

Printer-friendly Version

Interactive Discussion

sition zone between subtropical and midlatitude regimes in seasonality. There, spring (summer) mixing ratios decrease (increase) with latitude. North of 40° N, the UT ozone seasonal cycle is of midlatitude type characterized by highest mixing ratios in summer and lowest in winter. Comparing the GASP data with corresponding measurements from the eastern Pacific aircraft campaign database for the 1978–1999 period in the 8–9 km altitude region (DiNunno et al., 2003; their Figs. 5a and b), there is remarkable agreement in latitudinal UT ozone distribution: As observed by GASP, springtime ozone mixing ratios are found to be very low in the tropics ranging from 20 to 40 ppbv, to be highest in the latitude range of 15 to 25 ° N on the order of 60 to 80 ppbv and to be slightly lower between 40 and 60 ppbv further northward. During autumn, ozone from the aircraft database also exhibits low values over a broad latitude range (20 to 40 ppbv for latitudes <30° N) and slightly higher concentrations of 40 to 60 ppbv at middle latitudes.

4 Comparison of GASP ozone with early ozone soundings

In the previous section, the seasonal cycle of GASP UT/LS ozone has been shown to be mostly consistent with other available data and the literature. Another important information is the quantitative comparison with contemporary ozone data of the UT/LS.

Hemispheric-scale ozone data other than GASP are missing for the nineteen seventies, but long-term records from early balloon measurements, providing sufficient data for climatological analysis to be compared against GASP data, are available at the WOUDC archive (cf. Sect. 2.2). In turn, the GASP data provide an unprecedented opportunity to compare to historic ozonesonde measurements in the UT/LS region, an altitude region where hardly anything is known about the quality of the early balloon measurements due to missing measurements from other instruments.

A first comparison of GASP and American ozonesonde measurements from the 1960s and early 1970s was already published after the first two years of the GASP program by Holdeman et al. (1977). They stated that “ozone GASP data analyses to

GASP ozone climatology of the nineteen seventies

C. Schnadt Poberaj et al.

Title Page

Abstract

Introduction

Conclusions

References

Tables

Figures

◀

▶

◀

▶

Back

Close

Full Screen / Esc

Printer-friendly Version

Interactive Discussion

date have shown spatial and temporal variations which are in agreement with data from ozonesondes.” However, this first comparison was carried out using ozonesonde data from the American ozonesonde network of the nineteen sixties. The sensors utilised at that time were of the Regener type. According to personal communication with S. Oltmans from NOAA and H. De Backer from the Royal Institute of Belgium, these early sondes had problems in changing sensitivity of the chemiluminescent detector during the course of the ascent. They were also very sensitive to different kinds of pollutants and to humidity. It was later determined that the tropospheric response of the sensor was probably low relative to even the BM sensor. For these reasons, the Regener sondes were abandoned at the end of the nineteen sixties and substituted by the BM sensor. The results of the early comparison of GASP ozone with measurements of the Regener sondes must thus be considered with much precaution, and the conclusions drawn in Holdeman et al. (1977) should be restricted to qualitative statements such as agreements in latitudinal dependence and seasonal cycle.

In the present paper, we carry out an extended comparison between aircraft and the more reliable BM and ECC balloon data of the second half of the nineteen seventies, evaluating stratospheric and tropospheric ozone separately.

4.1 Comparison of GASP and ozonesonde data in the lower stratosphere

When comparing aircraft UV photometer and balloon data in the UT/LS region, it is of crucial importance to take into account the response time of the BM sensor, which principally results in an altitude shift of the balloon versus the aircraft data. Not considering it leads to largely different differences between aircraft and balloon ozone in the lowermost stratosphere, where vertical ozone gradients are most pronounced, and hence to different conclusions concerning the comparison of GASP and ozonesonde behaviour. Since the usual practice is not to correct for this lag in response (Harris et al., 1998), we introduce an according correction using the following assumptions: The ozonesonde response time has been estimated to amount to approximately 50 s for a 90% response to a step change in ozone (WMO, 1998). Assuming an average balloon

**GASP ozone
climatology of the
nineteen seventies**

C. Schnadt Poberaj et al.

Title Page

Abstract

Introduction

Conclusions

References

Tables

Figures

◀

▶

◀

▶

Back

Close

Full Screen / Esc

Printer-friendly Version

Interactive Discussion

ascent velocity of 5 ms^{-1} , this leads to an altitude correction of 250 m. Considering the that ascent velocity may vary and be somewhat lower than indicated above in the tropopause region (personal communication, W. Steinbrecht), we additionally apply a smaller correction of 150 m. Using actual ozonesonde temperatures and assuming hydrostatic equilibrium, climatological balloon profiles were then shifted downward by the above given distances.

The effect of the balloon altitude correction is displayed in Fig. 8, which presents climatological aircraft and ozonesonde profiles averaged over 2 K bins within a distance of $\pm 10 \text{ K}$ ($\approx -2 \text{ km}$ to $+ 1 \text{ km}$) for the spring period as an example. Principally, average sonde ozone mixing ratios are increased in a given layer by the altitude shift, the impact being largest at altitudes with maximum vertical gradients. It can clearly be seen that the correction significantly improves the agreement between aircraft and balloon profiles. The figure also elucidates that the two chosen altitude corrections of 150 m and 250 m represent lower and upper borders of realistic shifts of the sonde data, respectively.

Equivalent latitude bands, over which to average aircraft and balloon data, had to be chosen carefully to avoid biases of either GASP and/or ozonesonde averages. These could principally arise due to uneven latitudinal data coverage in the case of latitudinal gradients of ozone. Ozone gradients particularly exist at middle latitudes over all seasons (Fig. 9a). As is evident from Fig. 9b, GASP aircraft data are quite evenly distributed over the 40° N – 60° N EL and 60 to 80° N EL ranges with possible slight biases toward the more southern parts of the regions. These are due to a combination of changing data coverage with latitude (cf. Fig. 1) and with equivalent latitude areas becoming smaller with increasing latitude. For the European stations, 40° N – 60° N EL turned out to be the most suitable EL range as the measurements were quite evenly distributed within. Similar considerations led to the selection of ranges for the Canadian stations: 45° N – 65° N EL for Edmonton, 50° N – 70° N EL for Churchill and Goose Bay, and 60° N – 80° N EL for Resolute. For Wallops Island station, data were filtered for the 35° N – 50° N EL band.

**GASP ozone
climatology of the
nineteen seventies**

C. Schnadt Poberaj et al.

Title Page

Abstract

Introduction

Conclusions

References

Tables

Figures

◀

▶

◀

▶

Back

Close

Full Screen / Esc

Printer-friendly Version

Interactive Discussion

GASP ozone climatology of the nineteen seventies

C. Schnadt Poberaj et al.

Title Page

Abstract

Introduction

Conclusions

References

Tables

Figures

◀

▶

◀

▶

Back

Close

Full Screen / Esc

Printer-friendly Version

Interactive Discussion

Figure 10 shows relative differences between mean stratospheric ozone profiles deduced from GASP and European BM balloon data for 40° N–60° N EL. In contrast to Sect. 3, where GASP altitude/seasonal samples included all individual data in five years as basis for averaging, here daily means were computed first for GASP and ozonesondes for all vertical layers and seasons before averaging. For the GASP data, the methodology avoids biases from large numbers of measurement on individual days putting the comparison between balloon and aircraft data on a comparable temporal basis. The confidence intervals, displayed in Fig. 10, were calculated according to

$$CI = \pm t(P, Df) \cdot \sqrt{\sigma_G^2 / n_G + \sigma_S^2 / n_S} \quad (2)$$

where n_G and n_S denote the sample sizes of GASP and ozonesonde data, respectively, and σ_G^2 and σ_S^2 the sample variances. t designates the cutoff value in a Student's t distribution depending on the probability P and the degrees of freedom ($Df = n_G + n_S - 2$).

Figure 10 shows that differences in the lower stratosphere agree to $\pm 10\%$ in all seasons. For the largest part of the data, differences are statistically not significant.

Note that the tropopause layer averages (0 K) include data from both stratosphere and troposphere ($-5 \text{ K} < \Delta\theta \leq 5 \text{ K}$). This may, in individual seasons, lead to larger differences depending on how large the tropospheric and stratospheric fractions of data are. Moreover, tropopause layer data are filtered for equivalent latitudes, which may not be correct at these altitudes (cf. Sect. 2.2). Averaging over all stratospheric layers and seasons (10 K–60 K), not corrected (150 m altitude corrected) [250 m altitude corrected] sonde ozone deviates from GASP by $-6 \pm 10\%$ ($0 \pm 8\%$) [$4 \pm 8\%$], $-9 \pm 9\%$ ($-3 \pm 7\%$) [$1 \pm 5\%$], and $-5 \pm 6\%$ ($-1 \pm 7\%$) [$2 \pm 9\%$] at MOHP, Uccle, and Payerne, respectively. Obviously, applying the altitude correction to the sonde data tends to shift differences between sonde and aircraft LS ozone to more positive values. The use of the altitude correction can also be assessed by means of the annual mean absolute LS

difference between sonde and GASP

$$|\Delta O_{3LS}| = \frac{1}{n_{LS}} \sum_{i=1}^{n_{LS}} |O_{3Sondei} - O_{3GASPi}| \quad (3)$$

with n_{LS} designating the number of stratospheric layers, $O_{3Sondei}$, and O_{3GASPi} seasonal means at layer i , and the horizontal averaging bar the annual mean. In the case of MOHP and Uccle, a significant reduction of 40% and 40% (60%) in mean differences is achieved when applying an altitude shift of 150 m (250 m). Only at Payerne, where differences change sign over altitude in most seasons, no significant improvement in annual mean absolute difference is seen.

Comparing Uccle with MOHP and Payerne, the Uccle data appear to deviate slightly more negatively from the aircraft data than the other stations. This would be consistent with the smaller correction factors applied to the homogenised ozone series (Sect. 2.2) and give a hint that the used correction may not be completely sufficient in the UT/LS. However, due to limited sample sizes of GASP and ozonesonde data this assumption is afflicted with considerable uncertainty and remains speculative.

To study the causes of the differences found between GASP aircraft and European BM ozonesonde measurements, it would be necessary to compare with other UV photometer/ozonesonde intercomparisons of that time. These are, however, not available for the 1970s. Only within the scope of the Balloon Ozone Intercomparison Campaign (BOIC), carried out between June 1983 and March 1984, were BM instruments compared with UV photometers (and ECC sensors) (Hilsenrath et al., 1986). Unfortunately, a thorough discussion of differences between BM sensors and the reference UV photometers is missing. Validation with more recent ozone intercomparisons in the 1990s may be problematic due to changes of ozonesondes over time including changes in the preparation procedures or in the solute concentration (e.g., De Backer, 1999; Jeannet et al., 2006²). The issue will be discussed in a forthcoming publication within the

² Jeannet, P., Stübi, R., Levrat, G., Viatte, P., and Staehelin, J.: Ozone balloon soundings at Payerne (Switzerland): re-evaluation of the time series 1967–2002 and trend analysis,

GASP ozone climatology of the nineteen seventies

C. Schnadt Poberaj et al.

Title Page

Abstract

Introduction

Conclusions

References

Tables

Figures

◀

▶

◀

▶

Back

Close

Full Screen / Esc

Printer-friendly Version

Interactive Discussion

scope of a comparison between long-term changes derived from GASP/MOZAIC and ozonesondes.

Despite the number of ascents at the Canadian stations being significantly smaller than at the European stations (Table 2) and sample sizes being accordingly small (Fig. 11), relative differences found between climatological ozone profiles at the Canadian stations and GASP are comparable to the differences found between European balloon and GASP ozone (Fig. 10): During SON and DJF relative differences are mostly within the range of $\pm 10\%$. During spring and more so during summer, the ozonesonde profiles deviate slightly positively from the aircraft profiles by up to 10% and around 5–15%, respectively. Parts of these discrepancies are probably be due to 5 10 15
unequally distributed data within the selected equivalent latitude ranges combined with relatively large latitudinal gradients in ozone (Fig. 9a). Since GASP data are somewhat biased to the more southern parts of the averaging regions (Fig. 9b), while ozonesonde data are not as much (not shown), GASP climatological ozone will be somewhat lower than balloon ozone.

In laboratory experiments, the response of the early (1970s) Canadian ozonesondes was tested against an ozone calibrator (Tarasick et al., 2002). The results showed that in the UT/LS region (400 to 175 hPa), CF corrected sondes ranged between good agreement and a slight underestimation of reference ozone ($\approx 0\%$ –10%). However, 20
in our comparison, variability due to limited sample sizes, meteorology, and different regional averaging is too large to comment on their results.

Obviously, not using the ozonesonde corrections factors, as was done in the above comparison, would result in an underestimation of LS ozone compared to GASP. The effect of applying CFs will be discussed in more detail for LS and UT data together in Sect. 4.3. 25

At Wallops Island station, the combination of relatively few ascents (Table 2), a limited resolution of the profiles, and a comparatively high subtropical tropopause results in only very small number of data in the lower stratosphere. For this reason, Wallops

submitted to J. Geophys. Res., 2006.

**GASP ozone
climatology of the
nineteen seventies**

C. Schnadt Poberaj et al.

Title Page

Abstract

Introduction

Conclusions

References

Tables

Figures

◀

▶

◀

▶

Back

Close

Full Screen / Esc

Printer-friendly Version

Interactive Discussion

Island data were not evaluated in the LS.

4.2 Comparison of GASP and ozonesonde data in the upper troposphere

As already described in Sect. 2.4, comparing data in equivalent latitudes is not useful in the troposphere. For this reason, the 1975–1979 UT GASP data were extracted for the Europe (Eastern USA) region (Table 4) to be compared with sounding data of the Uccle, Hohenpeissenberg, and Payerne stations (Wallops Island station) for the same period of time. When comparing UT ozone averages for aircraft and balloon data, a potential altitude bias could be introduced by the different sampling methods with the aircraft recording at cruise altitudes and the balloons vertically sensing the atmosphere.

However, a thorough analysis of the selected regions yielded similar vertical distributions of the fraction of data collected for both GASP and ozonesonde measurements (not shown). Finally, the tropospheric balloon data were corrected for the response time of the ozonesondes (see previous section). As a result of the altitude shift, some data that had previously been assigned stratospheric, were reevaluated tropospheric. Through this effect, mean UT ozone values were somewhat enhanced at the European stations. On the contrary, no change of mean UT ozone mixing ratios resulted at Wallops Island, as the vertical resolution was too small to include this effect. Hence, to avoid resolution dependent influences on the UT means, UT data were only considered below -2 K below the tropopause at all stations, as well as for the GASP data.

Figure 12 displays the comparison between quasi-monthly mean GASP and sonde ozone, calculated from concurrent available daily mean ozone values in the UT for the period 1975–1979. Due to the limited number of coincident observations, data were not separated for seasons. As is obvious from Fig. 12, the spread of differences is very large at all four stations: at Uccle (MOHP) [Payerne]: the inner 90% of quasi-monthly mean differences cover the range of -22 to 40% (-35 to 74%) [-31 to 52%]. At Wallops Island/EasternUSA, 90% of differences are found within the range of -17 to 75% . The large scatter is, besides possible systematic biases in either sonde or aircraft ozone measurements or both, probably due to non-uniform ozone concentrations

GASP ozone climatology of the nineteen seventies

C. Schnadt Poberaj et al.

Title Page

Abstract

Introduction

Conclusions

References

Tables

Figures

◀

▶

◀

▶

Back

Close

Full Screen / Esc

Printer-friendly Version

Interactive Discussion

over the GASP averaging area leading to differences between the balloon site and the GASP area averages. Another influence factor for the scatter of differences at the European sites may have been the relatively low precision of BM sondes, which has been estimated to amount to $\pm 10\text{--}15\%$ for more recent sensors (Smit and Kley, 1998).

5 Very good agreement is found in terms of mean/median differences for the homogenised Uccle and MOHP data: the sonde data behave similarly versus GASP with mean and median differences showing similar values and being near zero (mean/median: $5\text{--}1\%$ and $2/4\%$, respectively). The comparison with the Payerne data indicates that the Payerne sensor may have measured somewhat less ozone
10 than GASP (and the other European balloon sensors). Whereas the mean difference is only marginally negative (-1%) and overlaid with large variability (31%), the median difference more clearly points to a negative deviation of the sonde from the aircraft data amounting to $-11\pm 15\%$. The difference between mean and median differences arises from individual positive outliers during the period 1975 through 1977, that shift
15 the mean difference to a more positive value. During 1978 and 1979, where most coincident data are available, 90% of quasi-monthly mean differences are negative. Note that during this period of time, Uccle and MOHP monthly mean values still vary around zero.

The median differences found here, ranging from 4 to -11% depending on station, are comparable to differences found in the laboratory experiments by Tarasick et al. (2002) (see previous section). Thus, our results (UT and LS) may indicate that the European BM sensors of the 1970s may have had similar response functions as the Canadian BM sondes. This is plausible as the preflight preparation procedure in the 1970s was commonly carried out after Mueller (1976) (except for MOHP, where the
20 sondes were already prepared according to Claude et al., 1987).

25 For the Wallops Island/Eastern USA comparison, a completely different picture evolves: There, the ECC sonde mean (median) is higher by 27% (25%) than that of GASP. These findings point in the same direction than those gained at the Balloon Ozone Intercomparison Campaign (BOIC) (see previous section). There, the Wallops

**GASP ozone
climatology of the
nineteen seventies**C. Schnadt Poberaj et al.

[Title Page](#)[Abstract](#)[Introduction](#)[Conclusions](#)[References](#)[Tables](#)[Figures](#)[◀](#)[▶](#)[◀](#)[▶](#)[Back](#)[Close](#)[Full Screen / Esc](#)[Printer-friendly Version](#)[Interactive Discussion](#)

Island sonde was also found to measure up to 20% more ozone in the troposphere than the average of all participating instruments (Hilsenrath et al., 1986, their Fig. 4).

Concluding, contrasting the GASP aircraft with ozonesonde comparisons of the BM and ECC instruments, the results presented here agree with earlier studies stating that early BM instruments measured less ozone than ECC sensors. The order of magnitude of differences indicated to be 10–25% in the literature (Attmannspacher and Dütsch, 1970; 1981; Hilsenrath et al., 1986; Beekmann et al., 1994) is confirmed by this study.

4.3 On the use of the correction factor CF

Two main corrections are applied to Brewer-Mast measurements. The first accounts for decreasing pump efficiency with decreasing atmospheric pressure. At altitudes of 400 hPa to 175 hPa that we are considering in this study, however, this effect is negligible (e.g., Steinbrecht et al., 1998; their Table 2).

The second correction consists of scaling the ozonesonde profiles to an independent measurement of the ozone column carried out by a Dobson or Brewer spectrophotometer (WMO, 1995; 1998). The scaling practice was already introduced in the 1960s, because it was found that BM sondes underestimate stratospheric ozone by 10–25% (Dütsch, 1966). To obtain equivalent sonde total ozone, the total ozone amount of the sonde is calculated including the ozone abundance above the balloon burst level. This is done by assuming constant ozone mixing ratio or by using a climatological mean as e.g., at the Wallops Island station (cf. Sect. 2.2). The ratio of column ozone by the independent measurement and the vertically integrated sonde ozone is called correction factor CF. To adjust the ozonesonde data, the CF is then multiplied to the whole balloon profile.

The application of the CF has been discussed controversially, since the use of one constant correction value may not be appropriate for the whole profile, and because errors in the total ozone measurement may be passed on to the sonde profile. In particular, errors occurring in the tropospheric measurement are only corrected properly if there is a significant effect on the total ozone measurement and, thus, on the correc-

GASP ozone climatology of the nineteen seventies

C. Schnadt Poberaj et al.

Title Page

Abstract

Introduction

Conclusions

References

Tables

Figures

◀

▶

◀

▶

Back

Close

Full Screen / Esc

Printer-friendly Version

Interactive Discussion

tion factor. This also means that measurement errors that do not affect sonde column ozone are left uncorrected by the normalisation procedure. For these reasons, and from empirical evidence, it has been recommended more recently by several authors not to use the CF for tropospheric ozone (Beekmann et al., 1995; WMO, 1998; De Backer et al., 1998; Thouret et al., 1998b).

Our analysis indicated that there is satisfying agreement between GASP aircraft and European/Canadian sonde ozone when applying the CF; with average CFs being on the order of 1.08, 1.21, 1.17, 1.18, 1.19, and 1.18 at MOHP, Payerne, Edmonton, Churchill, Goose Bay, and Resolute, respectively. Therefore, the agreement would be worse when ignoring the CF. Remember that the Uccle time series is homogenised, the average correction for the analysed altitude range being only 1.02 (Sect. 2.2). This implies only a minor effect when not using the correction. Assuming that GASP measurements are correct, ozonesondes would then underestimate LS ozone by -7% to -10% (MOHP), 12% to -20% (Payerne), -10% to -24% (Edmonton), -10% to -16% (Churchill), -13% to -17% (Goose Bay), and -12% to -20% (Resolute). In the UT, mean [median] relative differences also become more negative to amount to $-5\pm 32\%$ [$-8\pm 18\%$] and $-17\pm 28\%$ [$-26\pm 13\%$] at the MOHP and Payerne stations, respectively.

Assuming the Canadian and the European ozonesonde stations to have had similar responses over altitude (cf. discussion in previous sections), it must be suspected that the application of the CF does not necessarily correct the data to the true ozone mixing ratio at other altitudes: According to the early Canadian BM sonde response over altitude, simulated in the laboratory (Tarasick et al., 2002, their Figs. 6 and 7), ozone values in the lower and middle troposphere will probably still be underestimated, whereas the ozone mixing ratio in the stratosphere may even be overestimated by a few percent when applying the CF.

Considering the results of Tarasick et al. (2002), it would be optimal to adjust the 1970s BM profiles with altitude-dependent correction factors. Altitude-dependent corrections are being used by the Uccle station comprising all known influence factors affecting the ozone profile over 30 years of observations (De Backer, 1998; cf. Sect. 2.2).

**GASP ozone
climatology of the
nineteen seventies**

C. Schnadt Poberaj et al.

Title Page

Abstract

Introduction

Conclusions

References

Tables

Figures

◀

▶

◀

▶

Back

Close

Full Screen / Esc

Printer-friendly Version

Interactive Discussion

However, to our knowledge, the Uccle data are not corrected for a change in sensor sensitivity with altitude.

Hence, as long as altitude-resolved corrections adjusting for a change in response over altitude do not exist, our aircraft/ozonesonde comparison indicates that applying the CF yields reliable ozone mixing ratios in the UT/LS region for the MOHP and Pay-
5 erne, as well as the Canadian balloon data. As mentioned before in Sect. 4.1, Uccle ozone may be on the low side of the other observations, at least in the LS comparison, possibly indicating that their smaller correction factors may not be completely sufficient in the analysed altitude region.

10 Finally, due to changes in procedures of handling the BM sensors over time, our suggestion to use the CF may not be valid at later times, and should therefore be confined to the 1970s and the analysed altitude region.

5 Summary and conclusions

In this study, we have presented the UT/LS ozone data set of the aircraft program
15 GASP conducted by NASA between 1975 to 1979. The GASP data set has provided an unprecedented possibility to derive a large-scale ozone climatology of the UT/LS in the nineteen seventies. In particular, it has been possible to derive climatological information on the ozone content over the Pacific Ocean, a region where large-scale long-term measurements of the UT/LS have largely been missing until now. In addition,
20 GASP aircraft ozone has been used for comparison with data from regular balloon ascents of the same period of time.

Aircraft and ozonesonde climatologies were computed for LS and UT separately. All ozone measurements were scaled to the dynamical (2 PVU) tropopause and subsequently binned into vertical classes using potential temperature. To reduce longitudinal
25 variability, LS ozone measurements were rearranged into the equivalent latitude system, and quasi-zonal means were calculated to obtain characteristic mid- and high latitude ozone profiles: GASP five-year mean profiles reproduce the expected strato-

GASP ozone climatology of the nineteen seventies

C. Schnadt Poberaj et al.

Title Page

Abstract

Introduction

Conclusions

References

Tables

Figures

◀

▶

◀

▶

Back

Close

Full Screen / Esc

Printer-friendly Version

Interactive Discussion

spheric seasonal cycle with highest values in springtime, lower values in winter and lowest in autumn. Although measurements in the subtropical stratosphere are not as numerous, they indicate the same seasonality.

In the UT, aircraft measurements were averaged over specific regions that are covered by both GASP and MOZAIC flight routes: the eastern United States, the midlatitude Atlantic and Europe, the midlatitude and subtropical Northeastern Pacific Ocean, tropical regions in South Asia, as well as Japan. The GASP data set hence provides large-scale information on midlatitude and subtropical to tropical UT ozone in the nineteen seventies. The seasonal cycle and ozone concentrations are largely different depending on the region considered:

–Over the middle latitude regions of the eastern United States, the Atlantic, and Europe, GASP UT ozone shows a seasonal cycle in agreement with earlier literature with low values in autumn and winter, higher values in spring reflecting a peak in stratosphere-troposphere exchange and a maximum in summer probably due to both influence of photochemistry and transport from the stratosphere.

–Over the western United States, the seasonal cycle evolves differently showing a pronounced maximum in spring and somewhat lower values in summer. The results are in agreement with ozonesonde observations at Trinidad Head, California.

–The same type of seasonal cycle as over the western United States is also found over the midlatitude and subtropical northeastern Pacific. Over the subtropical Northeast Pacific, where UT ozonesonde records are available at Hilo, Hawaii, GASP ozone agrees well in qualitative and quantitative terms.

–Over Northern Japan, GASP ozone seasonality is characteristic for middle latitudes. Over subtropical-midlatitude Southern Japan, a spring maximum and much lower mixing ratios in summer and autumn are found. The north-south differences are qualitatively consistent with measurements from MOZAIC and ozonesonde observations.

–Over the northern hemisphere tropical regions, GASP ozone exhibits seasonal cycles characterised by a spring maximum. The spring maximum observed by GASP seems to be typical of the tropical region, it was also found during the NOXAR project,

GASP ozone climatology of the nineteen seventies

C. Schnadt Poberaj et al.

Title Page

Abstract

Introduction

Conclusions

References

Tables

Figures

◀

▶

◀

▶

Back

Close

Full Screen / Esc

Printer-friendly Version

Interactive Discussion

and during the INDOEX campaigns over the Indian Ocean. Over Northern and Southern India, a summer minimum is evident most probably related to convective activity.

The overall remarkable agreement of GASP ozone with other ozone data in terms of seasonality and concentrations in different regions of the world provides evidence that it represents a reliable large-scale data set of the nineteen seventies.

The GASP data set also provides new information on the vertical and horizontal distribution of UT/LS ozone above the northern hemisphere Pacific region:

–Tropical UT ozone was found to be lower by 10 to 20 ppbv between 170° W and 160° W than further east at 155° W–145° W. This finding is in agreement with tropospheric ozone columns derived from satellite instruments for the period 1979 to 2000. A possible explanation of the lower values in the more western region could be uplift of ozone poor air masses within tropical convection in the warm pool area.

–Over the west coast of the USA, GASP UT summertime ozone was higher than over the adjacent Pacific. It is possible that the effect can be attributed to air pollution over southern California.

–Over the Northeast Pacific, tropical ozone mixing ratios are much lower than at subtropical and middle latitudes during all seasons. The seasonal cycle at tropical to subtropical latitudes is characterized by largest values in spring, comparable mixing ratios in summer and winter, and lowest in autumn. A plausible explanation for the high springtime mixing ratios could be deep cross-tropopause transport from the lower stratosphere into the upper troposphere in the subtropical jetstream area. In terms of seasonality, the latitude zone between 30° N and 40° N is a transition zone: spring (summer) mixing ratios decrease (increase) with latitude. North of 40° N, the UT ozone seasonal cycle is of midlatitude type characterized by highest mixing ratios in summer and lowest in winter. The latitudinal dependence is in agreement with a climatology of observations deduced from aircraft campaigns during 1978–1999.

Another important evaluation of the GASP data set is given by a quantitative comparison with contemporary regular balloon measurements at European, Canadian, and US American long-term ozonesonde sites.

**GASP ozone
climatology of the
nineteen seventies**

C. Schnadt Poberaj et al.

Title Page

Abstract

Introduction

Conclusions

References

Tables

Figures

◀

▶

◀

▶

Back

Close

Full Screen / Esc

Printer-friendly Version

Interactive Discussion

**GASP ozone
climatology of the
nineteen seventies**

C. Schnadt Poberaj et al.

[Title Page](#)[Abstract](#)[Introduction](#)[Conclusions](#)[References](#)[Tables](#)[Figures](#)[◀](#)[▶](#)[◀](#)[▶](#)[Back](#)[Close](#)[Full Screen / Esc](#)[Printer-friendly Version](#)[Interactive Discussion](#)

–For the quantitative comparison of GASP and ozonesondes, it was found to be of importance to correct the sonde data for an altitude offset of 150 m to 250 m due to the slow response time of the sensors. This shift in sonde data is especially relevant in the LS, where vertical gradients in ozone are large. Applying the correction to the balloon data, the annual mean deviation of LS sonde ozone from GASP is reduced by 40% to 60% at MOHP and Uccle.

–In the LS, equivalent latitude averages of early European and Canadian BM ozonesonde profiles mostly agree within $\pm 10\%$ with GASP ozone in all seasons.

–In the UT, GASP data of the Europe and USA East regions were compared with coincident sonde data of the European and Wallops Island balloon stations, respectively. Over Europe, BM ozone deviated, on average, only by a few percent from GASP ozone, however, with large variability overlaid. Only at Payerne, balloon ozone showed somewhat lower median ozone than GASP by -11% . Over the eastern United States, in contrast, systematic positive deviations of the ECC sonde measurements from the aircraft data are found amounting to about 25%. The findings agree with results from the Balloon Ozone Intercomparison Campaign in 1983/84, where the Wallops Island sonde measured up to 20% more ozone in the troposphere than the average of all participating instruments. Considering the noise inherent to our results in the tropospheric analysis, there is qualitative agreement with the results from the stratospheric analysis. The order of magnitude of differences between BM and ECC sensors indicated to be 10–25% in the literature is confirmed by this study.

–The GASP/ozonesonde comparison indicates that applying the CF to the 1970s BM ozonesondes yields reliable ozone mixing ratios in the UT/LS region for the MOHP and Payerne, as well as the Canadian balloon data. The altitude-dependent correction factors, used at Uccle, are considerably smaller than the average CF (1.02 vs. 1.23), and may be somewhat too small in the LS. Due to changes in procedures of handling the BM sensors over time, our suggestion to use the CF in the UT/LS should be confined to the 1970s and the analysed altitude region.

To conclude, our analysis shows that after careful preparation of the data set, GASP

ozone measurements can, in general, be considered a reasonable and reliable data set. The GASP data thus represent a valuable data set to compare with more recent UT/LS aircraft data such as MOZAIC to deduce long-term changes of UT/LS ozone, which will be addressed in a forthcoming publication. They also add to the few other possibilities to validate global chemistry transport and chemistry-climate models for simulations of the 1970s.

ACPD

7, 3451–3517, 2007

**GASP ozone
climatology of the
nineteen seventies**

C. Schnadt Poberaj et al.

Title Page

Abstract

Introduction

Conclusions

References

Tables

Figures

◀

▶

◀

▶

Back

Close

Full Screen / Esc

Printer-friendly Version

Interactive Discussion

EGU

Acknowledgements. This work has been carried out in the framework of the project RETRO sponsored by the European Union under contract EVK2-CT-2002-00170. We thank A. Detwiler for providing us the GASP data. Special thanks also goes to the MOZAIC team for making their data available to us. In this regard, the authors also gratefully acknowledge the strong support of the MOZAIC program by the European Communities, EADS, Airbus, and the airlines Lufthansa, Austrian, and Air France who have carried the MOZAIC equipment free of charge since 1994. ERA40 reanalysis data have been provided by the NOAA- CIRES Climate Diagnostics Center, Boulder, Colorado, USA, from their Web site at <http://www.cdc.noaa.gov/>. The ozonesonde data were obtained from the World Ozone and Ultraviolet Radiation Data Centre (WOUDC) operated by Environment Canada, Toronto, Ontario, Canada under the auspices of the World Meteorological Organization. From WOUDC, we are grateful to Ed Hare for much helpful support concerning the ozonesonde metadata. We would further like to thank F. Schmidlin from NASA Wallops Flight Facility at Wallops Island, as well as Sam Oltmans from NOAA for comprehensive information on the Wallops Island ozonesonde measurements and for providing SBUV corrections factors for their ozonesonde records. The processed GASP data can be downloaded from the ETHmeg database (<http://www.megdb.ethz.ch>).

References

- Attmannspacher, W. and Dütsch, H.: International ozone sonde intercomparison at the observatory of Hohenpeissenberg, *Berichte des Deutschen Wetterdienstes*, 120, 1–47, 1970.
- Attmannspacher, W. and Dütsch, H.: 2nd international ozone sonde intercomparison at the observatory of Hohenpeissenberg, *Berichte des Deutschen Wetterdienstes*, 157, 1–64, 1981.
- Beekmann, M., Ancellet, G., and Mégie, G.: Climatology of tropospheric ozone in southern Europe and its relation to potential vorticity, *J. Geophys. Res.*, 99, 12 841–12 853, 1994.
- Beekmann, M., Ancellet, G., Martin, D., Abonnel, C., Duverneuil, G., Eideliman, F., Bessemoulin, P., Fritz, N., and Gizard, E.: Intercomparison of tropospheric ozone profiles obtained by electrochemical sondes, a ground based lidar and an airborne UV-photometer, *Atmos. Env.*, 29, 1027–1042, 1995.
- Brewer, A. and Milford, J.: The Oxford Kew ozone sonde, *Proc. Roy. Soc. London, Ser. A*, 256, 470, 1960.
- Brunner, D., Staehelin, J., Jeker, D., and Wernli, H.: Nitrogen oxides and ozone in the

Title Page

Abstract

Introduction

Conclusions

References

Tables

Figures

◀

▶

◀

▶

Back

Close

Full Screen / Esc

Printer-friendly Version

Interactive Discussion

- tropopause region of the Northern Hemisphere: Measurements from commercial aircraft in 1995/1996 and 1997, *J. Geophys. Res.*, 106, 27 673–27 699, 2001.
- Cammas, J.-P., Jacoby-Koaly, S., Suhre, K., Rosset, R., and Marenco, A.: Atlantic subtropical potential vorticity barrier as seen by Measurements of Ozone by Airbus In-Service Aircraft (MOZAIC) flights, *J. Geophys. Res.*, 103, 25 681–25 693, 1998.
- Claude, H., Hartmannsgruber, R., and Köhler, U.: Measurement of atmospheric profiles using the Brewer-Mast sonde, WMO Report 17, Global Ozone Research and Monitoring Project, WMO, Geneva, Switzerland, 1987.
- Danielsen, E.: Stratospheric-tropospheric exchange based on radioactivity, ozone and potential vorticity, *J. Atmos. Sci.*, 25, 502–518, 1968.
- De Backer, H.: Homogenisation of ozone vertical profile measurements at Uccle, Publication scientifique et technique, 7, edited by L'Institut Royal Meteorologique De Belgique, Avenue Circulaire 3, B-1180, Bruxelles, 1999.
- De Laat, A. T. J.: On the origin of tropospheric O₃ over the Indian Ocean during the winter monsoon: African biomass burning vs. stratosphere-troposphere exchange, *Atmos. Chem. Phys.*, 2, 325–341, 2002, <http://www.atmos-chem-phys.net/2/325/2002/>.
- Dias-Lalcaca, P., Brunner, D., Imfeld, W., Moser, W., and Staehelin, J. : An automated system for the measurement of nitrogen oxides and ozone concentrations from a passenger aircraft – Instrumentation and first results of the NOXAR project, *Environm. Sci. Technol.*, 32, 3228–3236, 1998.
- DiNunno, B., Davis, D., Chen, G., Gregory, G., Sachse, G., Anderson, B., Vay, S., Avery, M., Ridley, B., Carroll, M., Walega, J., Montzka, D. Grahek, F., Bradshaw, J., Sandholm, S. Kondo, Y., Kok, G., Blake, D., Barrick, J., Fuelberg, H., Martin, B., and Balok, A.: Central/eastern North Pacific photochemical precursor distributions for fall/spring seasons as defined by airborne field studies, *J. Geophys. Res.*, 108, doi:10.1029/2001JD001044, 2003.
- Dütsch, H. U.: Two years of regular ozone soundings over Boulder, Colorado, NCAR Tech. Note, NCAR TN-10, Nat. Cent. for Atmos. Res., Boulder, Colorado, 1966.
- Falconer, P. D. and Holdeman, J. D.: Measurements of atmospheric ozone made from a GASP-equipped 747 airliner Mid-March, 1975, *Geophys. Res. Lett.*, 3, 101–104, 1976.
- Falconer, P. D., Pratt, R. W., and Mohnen, V. A.: The transport of atmospheric ozone and its measurements from aircraft and the Earth's surface, ASRC Publ. 656, pp. 109–147, Dep. of Transp., Fed. Aviat. Admin., Washington, D.C., 1978.
- Falconer, P. D. and Pratt, R. W.: A summary of research on the NASA-Global Atmospheric

**GASP ozone
climatology of the
nineteen seventies**C. Schnadt Poberaj et al.

Title Page

Abstract

Introduction

Conclusions

References

Tables

Figures

◀

▶

◀

▶

Back

Close

Full Screen / Esc

Printer-friendly Version

Interactive Discussion

**GASP ozone
climatology of the
nineteen seventies**

C. Schnadt Poberaj et al.

Title Page

Abstract

Introduction

Conclusions

References

Tables

Figures

◀

▶

◀

▶

Back

Close

Full Screen / Esc

Printer-friendly Version

Interactive Discussion

sampling program performed by the atmospheric sciences research center, Rep. NASA CR-1569614, 58 pp., NASA Lewis Res. Cent., Cleveland, Ohio, June 1979.

Falconer, P. D., Pratt, R., Detwiler, A., Chen, C.-S., Hogan, A., Bernard, S., Krebschull, K., and Winters, W.: Aircraft Measurements of Trace Gases and Particles Near the Tropopause, Rep. NASA CR 3691, NASA Lewis Res. Cent., Cleveland, Ohio, June 1983.

Fishman, J., Wozniak, A. E., and Creilson, J. K.: Global distribution of tropospheric ozone from satellite measurements using the empirically corrected tropospheric ozone residual technique: Identification of the regional aspects of air pollution, *Atmos. Chem. Phys.*, 3, 893–907, 2003, <http://www.atmos-chem-phys.net/3/893/2003/>.

Forster, P. M. de F. and Shine, K. P.: Radiative forcing and temperature trends from stratospheric ozone changes, *J. Geophys. Res.*, 102, 10 841–10 855, 1997.

Gauntner, D. J., Holdeman, J. D., Briehl, D., and Humenik, F. M.: Description and review of global measurements from GASP, NASA Tech. Memo., TM-73781, 18 pp., 1977.

Gregory, G. L., Westberg, D. J., Shipham, M. C., Blake, D. R., Newell, R. E., Fuelberg, H. E., Talbot, R. W., Heikes, B. G., Atlas, E. L., Sachse, G. W., Anderson, B. A., and Thornton, D. C.: Chemical characteristics of Pacific tropospheric air in the region of the Intertropical Convergence Zone and South Pacific Convergence Zone, *J. Geophys. Res.*, 104, 5677–5696, 1999.

Grosjean, D.: Ambient PAN and PPN in southern California from 1960 to the SCOS97-NARSTO, *Atmos. Env.*, 37, 221–238, 2003.

Hearn, A. G.: The Absorption of Ozone in the Ultra-violet and Visible Regions of the Spectrum, *Proc. Phys. Soc.*, 78, 932–940, 1961.

Hegglin, M. I., Brunner, D., Peter, T., Hoor, P., Fischer, H., Staehelin, J., Krebsbach, M., Schiller, C., Parchatka, U., and Weers, U.: Measurements of NO, NO_y, N₂O, and O₃ during SPURT: implications for transport and chemistry in the lowermost stratosphere, *Atmos. Chem. Phys.*, 6, 1331–1350, 2006, <http://www.atmos-chem-phys.net/6/1331/2006/>.

Helten, M., Smit, H. G. J., Sträter, W., Kley, D., Nedelec, P., Zöger, M., and Busen, R.: Calibration and performance of automatic compact instrumentation for the measurement of relative humidity from passenger aircraft, *J. Geophys. Res.*, 103, 25 643–25 652, 1998.

Hilsenrath, E., Attmannspacher, W., Bass, A., Evans, W., Hagemeyer, R., Barnes, R. A., Komhyr, W., Mauersberger, K., Mentall, J., Profitt, M., Robbins, D., Taylor, S., Torres, A., and Weinstock, E.: Results from the balloon ozone intercomparison campaign (BOIC), *J. Geophys. Res.*, 91, 13 137–13 152, 1986.

- Holdeman, J. D., Nastrom, G. D., and Falconer, P. D.: An analysis of the first two years of GASP data, NASA Tech. Memo., TM-73817, 9 pp., 1977.
- Holdeman, J. D., Dudzinski, T. J., Nyland, T. W., and Tiefermann, M. W.: NASA Global Atmospheric Sampling Program (GASP) data report for tape VL0009, NASA Tech. Memo., TM-79058, 35 pp., 1978.
- Holdeman, J. D. and Nastrom, G. D.: Ozone Contamination in Aircraft Cabins: Results from GASP Data and Analyses, NASA Tech. Memo., TM-81671, 7pp., 1981a.
- Holdeman, J. D. and Nastrom, G. D.: Analysis of Atmospheric Ozone Levels at Commercial Airplane Cruise Altitudes in Winter and Spring 1976–77, NASA Tech. Paper 1807, FAA-EE-81-1, 15pp., 1981b.
- IPCC (Intergovernmental Panel on Climate Change): Climate change 2001: The scientific basis. Contribution of Working Group 1 to the Third Assessment Report, edited by: Houghton, J. T., Cambridge University Press, Cambridge, United Kingdom and New York, NY, USA, 881 pp., 2001.
- Johnson, J. E., Gammon, R. H., Larsen, J., Bates, T. S., Oltmans, S. J., and Farmer, J. C.: Ozone in the marine boundary layer over the Pacific and Indian Oceans: Latitudinal gradients and diurnal cycles, *J. Geophys. Res.*, 95, 11 847–11 856, 1990.
- Klausen, J., Zellweger, C., Buchmann, B., and Hofer, P.: Uncertainty and bias of surface ozone measurements at selected Global Atmosphere Watch sites, *J. Geophys. Res.*, 108, doi:10.1029/2003JD003710, 2003.
- Kley, D.: Tropospheric Chemistry and Transport, *Science*, 276, 1043–1045, 1997.
- Kley, D., Smit, H. G. J., Vömel, H., Grassl, H., Ramanathan, V., Crutzen, P. J., Williams, S., Meyerwerk, J., and Oltmans, S. J.: Tropospheric water-vapour and ozone cross-sections in a zonal plane over the central equatorial Pacific Ocean, *Q. J. R. Met. Soc.*, 123, 2009–2040, 1997.
- Komhyr, W. D.: Electrochemical concentration cells for gas analysis, *Ann. Geoph.*, 25, 203–210, 1969.
- Komhyr, W. D.: Development of an ECC-Ozonesonde, NOAA Techn. Rep. ERL 200-APCL 18ARL-149, 1971.
- Kulshreshta, U. C., Jain, M., and Parashar, D. C.: Concentrations and behavior of surface O₃, NO and NO₂ at Delhi, *Indian J. Radio Space Phys.*, 26, 82–84, 1997.
- Law, K. S., Plantevin, P. H., Shallcross, D. E., Rogers, H. L., Pyle, J. A., Grouhel, C., Thouret, V., and Marenco, A.: Evaluation of modeled O₃ using Measurement of Ozone

GASP ozone climatology of the nineteen seventies

C. Schnadt Poberaj et al.

Title Page

Abstract

Introduction

Conclusions

References

Tables

Figures

◀

▶

◀

▶

Back

Close

Full Screen / Esc

Printer-friendly Version

Interactive Discussion

by Airbus In-Service Aircraft (MOZAIC) data, *J. Geophys. Res.*, 103(D19), 25 721–25 737, doi:10.1029/98JD01482, 1998.

Liu, S. C., McFarland, M., Kley, D., Zafiriou, O., and Huebert, B.: Tropospheric NO_x and O₃ budgets in the equatorial Pacific, *J. Geophys. Res.*, 88, 1360–1368, 1983.

5 Liu, H., Jacob, D. J., Chan, L. Y., Oltmans, S. J., Bey, I., Yantosca, R. M., Harris, J. M., Duncan, B. N., and Martin, R. V.: Sources of tropospheric ozone along the Asian Pacific Rim: An analysis of ozonesonde observations, *J. Geophys. Res.*, 107, doi:10.1029/2001JD002005, 2002.

Logan, J. A.: Tropospheric ozone: Seasonal behavior, trends and anthropogenic influence, *J. Geophys. Res.*, 90, 10 463–10 482, 1985.

10 Logan, J. A.: Trends in the vertical distribution of ozone: An analysis of ozonesonde data, *J. Geophys. Res.*, 99, 25 553–25 585, 1994.

Logan, J. A.: An analysis of ozonesonde data for the troposphere: Recommendation for testing 3-D models and development of a gridded climatology for tropospheric ozone, *J. Geophys. Res.*, 104, 16 115–16 149, 1999.

15 Logan, J. A., Megretskaia, I. A., Miller, A. J., Tiao, G. C., Choi, D., Zhang, L., Stolarski, R. S., Labow, G. J., Hollandsworth, S. M., Bodeker, G. E., Claude, H., De Muer, D., Kerr, J. B., Tarasick, D. W., Oltmans, S. J., Johnson, B., Schmidlin, F., Staehelin, J., Viatte, P., and Uchino, O.: Trends in the vertical distribution of ozone: A comparison of two analyses of ozonesonde data, *J. Geophys. Res.*, 104, 26 373–26 399, 1999.

Marengo, A., Thouret, V., Nédélec, P., Smit, H., Helten, M., Kley, D., Karcher, F., Simon, P., Law, K., Pyle, J., Poschmann, G., Von Wrede, R., Hume, C., and Cook, T.: Measurement of ozone and water vapour by Airbus in-service aircraft: The MOZAIC program, An overview, *J. Geophys. Res.*, 103, 25 631–25 642, 1998.

25 McPeters, R. D., Labow, G. J., and Johnson, B. J.: A satellite-derived ozone climatology for balloonsonde estimation of total column ozone, *J. Geophys. Res.*, 102, 8875–8885, 1997.

Mueller, J. I.: Flight preparation instructions for the model 730-8 ozonesondes, Mast Development Company, Iowa, 1976.

30 Naja, M. and Lal, S.: Changes in surface ozone amount and its diurnal and seasonal patterns, from 1954–55 to 1991–93, measured at Ahmedabad (23 N), India, *Geophys. Res. Lett.*, 23, 81–84, 1996.

Naja, M. and Lal, S.: Surface ozone and precursor gases at Gadanki (13.5° N, 79.2° E), a tropical rural site in India, *J. Geophys. Res.*, 107, doi:10.1029/2001JD000357, 2002.

**GASP ozone
climatology of the
nineteen seventies**

C. Schnadt Poberaj et al.

Title Page

Abstract

Introduction

Conclusions

References

Tables

Figures

◀

▶

◀

▶

Back

Close

Full Screen / Esc

Printer-friendly Version

Interactive Discussion

**GASP ozone
climatology of the
nineteen seventies**

C. Schnadt Poberaj et al.

Title Page

Abstract

Introduction

Conclusions

References

Tables

Figures

◀

▶

◀

▶

Back

Close

Full Screen / Esc

Printer-friendly Version

Interactive Discussion

- Naja, M. and Akimoto, H.: Contribution of regional pollution and long-range transport to the Asia-Pacific region: Analysis of long-term ozonesonde data over Japan, *J. Geophys. Res.*, 109, doi:10.1029/2004JD004687, 2004.
- Nastrom, G. D.: Vertical and horizontal fluxes of ozone at the tropopause from the first year of GASP data, *J. Appl. Meteor.*, 16, 740–744, 1977.
- Nastrom, G. D.: Ozone in the upper troposphere from GASP measurements, *J. Geophys. Res.*, 84, 6383–6388, 1979.
- Newchurch, M. J., Ayoub, M. A., Oltmans, S., Johnson, B., and Schmidlin, F. J.: Vertical distribution of ozone at four sites in the United States, *J. Geophys. Res.*, 108, doi:10.1029/2002JD002059, 2003.
- Oltmans, S. J., Hofmann, D. J., Lathrop, J. A., Harris, J. M., Komhyr, W. D., and Kuniyuki, D.: Tropospheric ozone during Mauna Loa Observatory Photochemistry Experiment 2 compared to long-term measurements from surface and ozonesonde observations, *J. Geophys. Res.*, 101, 14 569–14 580, 1996.
- Oltmans, S. J., Johnson, B. J., Harris, J. M., Vömel, H., Thompson, A. M., Koshy, K., Simon, P., Bendura, R. J., Logan, J. A., Hasebe, F., Shiotani, M., Kirchhoff, V. W. J. H., Maata, M., Sami, G., Samad, A., Tabuadravu, J., Enriquez, H., Agama, M., Cornejo, J., and Paredes, F.: Ozone in the Pacific tropical troposphere from ozonesonde observations, *J. Geophys. Res.*, 106, 32 503–32 525, 2001.
- Oltmans, S. J., Johnson, B. J., Harris, J. M., Thompson, A. M., Liu, H. Y., Chan, C. Y., Vömel, H., Fujimoto, T., Brackett, V. G., Chang, W. L., Chen, J.-P., Kim, J. H., Chan, L. Y., and Chang, H.-W.: Tropospheric ozone over the North Pacific from ozonesonde observations, *J. Geophys. Res.*, 109, doi:10.1029/2003JD003466, 2004.
- Piotrowicz, S. R., Boran, D. A.; and Fischer, C. J.: Ozone in the boundary layer of the equatorial Pacific Ocean, *J. Geophys. Res.*, 91, 13 113–13 119, 1986.
- Piotrowicz, S. R., Bezdek, H. F., Harvey, G. R., Springer-Young, M., and Hanson, K. J.: On the ozone minimum over the equatorial Pacific Ocean, *J. Geophys. Res.*, 96, 18 679–18 687, 1991.
- Reynolds, R. W. and Smith, T. M.: A High-Resolution Global Sea Surface Temperature Climatology, *J. Climate*, 8, 1571–1583, 1995.
- Singh, H. B., Herlth, D., Kolyer, R., Salas, L., Bradshaw, J. D., Sandholm, S. T., Davis, J. Crawford, D. D., Kondo, Y., Koike, M., Talbot, R., Gregory, G. L., Sachse, G. W., Browell, E., Blake, D. R., Rowland, F. S., Newell, R., Merrill, J., Heikes, B., Liu, S. C., Crutzen, P.

**GASP ozone
climatology of the
nineteen seventies**

C. Schnadt Poberaj et al.

Title Page

Abstract

Introduction

Conclusions

References

Tables

Figures

◀

▶

◀

▶

Back

Close

Full Screen / Esc

Printer-friendly Version

Interactive Discussion

J., and Kanakidou, M.: Reactive nitrogen and ozone over the western Pacific: Distribution, partitioning, and sources, *J. Geophys. Res.*, 101, 1793–1808, 1996.

Smit, H. G. J and D. Kley: JOSIE: The 1996 WMO International intercomparison of ozonesondes under quasi flight conditions in the environmental simulation chamber at Jülich, WMO/IGAC-Report, WMO Global Atmosphere Watch report series, No. 130 (Technical Document No. 926). World Meteorological Organization, Geneva, 1998.

Staehelin, J., Harris, N. R. P., Appenzeller, C., and Everhard, J.: Ozone trends: a review, *Rev. Geophys.*, 39, 231–290, 2001.

Steinbrecht, W., Schwarz, R., and Claude, H.: New Pump Correction for the Brewer-Mast Ozone Sonde: Determination from Experiment and Instrument Intercomparisons, *J. Atmos. Ocean. Techn.*, 15, 144–156, 1998.

Stohl, A., Wernli, H., James, P., Bourqui, M., Forster, C., Liniger, M. A., Seibert, P., and Sprenger, M.: A new perspective of stratosphere-troposphere exchange, *Bull. Am. Met. Soc.*, doi:10.1175/BAMS-84-11-565, 2003.

Tarasick, D. W., Davies, J., Anlauf, K., Watt, M., Steinbrecht, W., and Claude, H. J.: Laboratory investigations of the response of Brewer-Mast ozonesondes to tropospheric ozone, *J. Geophys. Res.*, 107, doi:10.1029/2001JD001167, 2002.

Thompson, A. M., Johnson, J. E., Torres, A. L., Bates, T. S., Kelly, K. C., Atlas, E., Greenberg, J. P., Ponahne, N. M., Yvon, S. A., Saltzman, E. S., Heikes, B. G., Mosher, B. W., Shashkov, A. A., and Yegorov, V. I.: Ozone observations and a model of marine boundary-layer photochemistry during SAGA 3, *J. Geophys. Res.*, 98, 16 955–16 968, 1993.

Thouret, V., Marenco, A., Nédélec, P., and Grouhel, C.: Ozone climatologies at 9–12 km altitude as seen by the MOZAIC airborne program between September 1994 and August 1996, *J. Geophys. Res.*, 103, 25 653–25 679, 1998a.

Thouret, V., Marenco, A., Logan, J. A., Nédélec, P., and Grouhel, C.: Comparisons of ozone measurements from the MOZAIC airborne program and the ozone sounding network at eight locations, *J. Geophys. Res.*, 103, 25 695–25 720, 1998b.

Thouret, V., Cammas, J.-P., Sauvage, B., Athier, G., Zbinden, R., Nédélec, P., Simon, P., and Karcher, F.: Tropopause referenced ozone climatology and inter-annual variability (1994–2003) from the MOZAIC programme, *Atmos. Chem. Phys.*, 6, 1033–1051, 2006, <http://www.atmos-chem-phys.net/6/1033/2006/>.

Tieferrmann, M. W.: Ozone Measurement System for NASA Global Air Sampling Program, NASA Tech. Paper 1451, 21 pp., NASA Lewis Res. Cent., Cleveland, Ohio, May 1979.

**GASP ozone
climatology of the
nineteen seventies**

C. Schnadt Poberaj et al.

Title Page

Abstract

Introduction

Conclusions

References

Tables

Figures

◀

▶

◀

▶

Back

Close

Full Screen / Esc

Printer-friendly Version

Interactive Discussion

Uppala, S. M., Kållberg, P. W., Simmons, A. J., Andrae, U., da Costa Bechtold, V., Fiorino, M., Gibson, J. K., Haseler, J., Hernandez, A., Kelly, G.A., Li, X., Onogi, K., Saarinen, S., Sokka, N., Allan, R. P., Andersson, E., Arpe, K., Balmaseda, M. A., Beljaars, A. C. M., van de Berg, L., Bidlot, J., Bormann, N., Caires, S., Chevallier, F., Dethof, A., Dragosavac, M., Fisher, M., Fuentes, M., Hagemann, S., Hólm, E., Hoskins, B. J., Isaksen, I., Janssen, P. A. E. M., Jenne, R., McNally, A. P., Mahfouf, J.-F., Morcrette, J.-J., Rayner, N. A., Saunders, R. W., Simon, P., Sterl, A., Trenberth, K. E., Untch, A., Vasiljevic, D., Viterbo, P., and Woollen, J.: The ERA-40 re-analysis, *Quart. J. R. Meteorol. Soc.*, 131, 2961–3012, doi:10.1256/qj.04.176, 2005.

Wang, Y., Jacob, D. J., and Logan, J. A.: Global simulation of tropospheric O₃-NO_x-hydrocarbon chemistry. 3. Origin of tropospheric ozone and effects of nonmethane hydrocarbons, *J. Geophys. Res.*, 103, 10 757–10 767, 1998.

Wild, O., Sundet, J. K., Prather, M. J., Isaksen, I. S. A., Akimoto, J., Browell, E. V., and Oltmans, S. J.: Chemical transport model ozone simulations for spring 2001 over the western Pacific: Comparisons with TRACE-P lidar, ozonesondes, and Total Ozone Mapping Spectrometer columns, *J. Geophys. Res.*, 108, doi:10.1029/2002JD003283, 2003.

WMO: Scientific Assessment of Ozone Depletion: 1994, Global Ozone Research and Monitoring Project, Report No. 37, Geneva, Switzerland, 1995.

WMO: Assessment of Trends in the Vertical Distribution of ozone, SPARC Rep. 1, Global Ozone Research and Monitoring Project, Report No. 43, Geneva, Switzerland, 1998.

Wozniak, A. G.: Exploratory Analysis of Global Atmospheric Sampling Program Data, Master Thesis, South Dakota School of Mines and Technology, Rapid City, South Dakota, 173 pp., 1997.

Zachariasse, M., van Velthoven, P. F. J., Smit, H. G. J., Lelieveld, J., Mandal, T. K., and Kelder, H.: Influence of stratosphere-troposphere exchange on tropospheric ozone over the tropical Indian Ocean during the winter monsoon, *J. Geophys. Res.*, 105, 15 403–15 416, 2000.

Zachariasse, M., Smit, H. G. J., van Velthoven, P. F. J., and Kelder, H.: Cross-tropopause and interhemispheric transports into the tropical free troposphere over the Indian Ocean, *J. Geophys. Res.*, 106, 28 441–28 452, 2001.

Zahn, A., Neubert, R., Maiss, M., and Platt, U.: Fate of long-lived trace species near the Northern Hemispheric tropopause: Carbon dioxide, methane, ozone, and sulfur hexafluoride, *J. Geophys. Res.*, 104, 13 923–13 942, 1999.

Zhang, M., Uno, I., Carmichael, G.R., Akimoto, H., Wang, Z., Tang, Y., Woo, J.-H., Streets,

D.G., Sachse, G.W., Avery, M.A., Weber, R.J., and Talbot, R.W.: Large-scale structure of trace gas and aerosol distributions over the western Pacific Ocean during the Transport and Chemical Evolution Over the Pacific (TRACE-P) experiment, *J. Geophys. Res.*, 108, doi:10.1029/2002JD002946, 2003.

5

ACPD

7, 3451–3517, 2007

**GASP ozone
climatology of the
nineteen seventies**

C. Schnadt Poberaj et al.

Title Page

Abstract

Introduction

Conclusions

References

Tables

Figures

◀

▶

◀

▶

Back

Close

Full Screen / Esc

Printer-friendly Version

Interactive Discussion

EGU

GASP ozone climatology of the nineteen seventies

C. Schnadt Poberaj et al.

Table 1. Characteristics of flight levels for GASP and MOZAIC data. Altitude ranges (hPa) represent predominant flight altitudes. Standard altitudes (km/kft) derived from standard pressure levels using the ICAO standard atmosphere.

Percent of Data: GASP	Percent of Data: MOZAIC	Altitude range (hPa)	Standard level		
			hPa	km	kft
4.2	2.8	288–286	287	9.5	31
10.5	12.1	263–259	262	10.1	33
1.3	2.0	250–249	250	10.4	34
19.3	20.8	242–236	238	10.7	35
4.2	4.3	228–226	227	10.9	36
0.1	4.3	223–221	222	11.1	36
20.9	13.7	218–215	216	11.3	37
1.1	4.1	207–204	206	11.6	38
15.9	8.5	198–195	196	11.9	39
7.3	–	180–178	179	12.5	41
1.8	–	163–161	162	13.1	43

Title Page

Abstract

Introduction

Conclusions

References

Tables

Figures

◀

▶

◀

▶

Back

Close

Full Screen / Esc

Printer-friendly Version

Interactive Discussion

GASP ozone climatology of the nineteen seventies

C. Schnadt Poberaj et al.

Table 2. Ozone sounding stations, total number of ascents during 03/1975–12/1979, number of ascents used in the study according to CF criterion (see text), and sensor type used. (*) Uccle ozone data available on WOUDC server are homogenised, further details see text. [**]: Number of concurrent GASP/ozonesonde dates used for tropospheric analysis (details in Sect. 4.2).

Station	Country	Lat (° N)	Lon (°)	Total Number	Number Used (% of total number)	Sensor
Resolute	Canada	74.72	−94.98	204	173 (85)	BM
Churchill	Canada	58.75	−94.07	202	135 (67)	BM
Edmonton	Canada	53.55	−114.1	193	152 (79)	BM
Goose Bay	Canada	53.32	−60.3	236	172 (73)	BM
Uccle	Belgium	50.8	4.35	644	479 (74)	BM (*)
Hohenpeissenberg	Germany	47.8	11.02	406	379 (93)	BM
Payerne	Switzerland	49.49	6.57	533	473 (89)	BM
Wallops Island	USA	37.93	−75.48	188	33 [**]	ECC

Title Page

Abstract

Introduction

Conclusions

References

Tables

Figures

◀

▶

◀

▶

Back

Close

Full Screen / Esc

Printer-friendly Version

Interactive Discussion

GASP ozone climatology of the nineteen seventies

C. Schnadt Poberaj et al.

Table 3. Linear (nonlinear) correlation coefficients and confidence intervals (99% significance level) between GASP ozone and ERA40 PV interpolated onto the respective flight tracks for the different seasons of the year and 10° latitude intervals. Linear (nonlinear) correlation coefficients are denoted in bold (normal) font type.

	10°–20° N	20°–30° N	30°–40° N	40°–50° N	50°–60° N	60°–70° N
DJF	0.37±0.06	0.77±0.01	0.87±0.01	0.90±0.01	0.87±0.01	0.68±0.05
MAM	0.41±0.05	0.66±0.02	0.85±0.01	0.90±0.01	0.88±0.01	0.80±0.03
JJA	0.40±0.05	0.55±0.03	0.81±0.01	0.82±0.01	0.86±0.01	0.82±0.02
SON	0.43±0.08	0.66±0.03	0.81±0.01	0.88±0.01	0.90±0.01	0.89±0.02

Title Page

Abstract

Introduction

Conclusions

References

Tables

Figures

◀

▶

◀

▶

Back

Close

Full Screen / Esc

Printer-friendly Version

Interactive Discussion

GASP ozone climatology of the nineteen seventies

C. Schnadt Poberaj et al.

Table 4. Definition of regions for calculating GASP regional averages of tropospheric ozone. Regions are listed in order as discussed in the text. (*) The USA East region is used in Sect. 4.2 only for comparison with Wallops Island ozonesonde data.

Region	Acronym	Latitudes	Longitudes
Atlantic	ATL	40° N–60° N	60° W–10° W
Europe	EUR	35° N–55° N	10° W–30° E
Northeastern USA	NE USA	40° N–50° N	90° W–60° W
Eastern USA (*)	E USA	30° N–50° N	90° W–60° W
Western USA	W USA	30° N–50° N	125° W–90° W
Midlatitude Northeast Pacific	ML NEP	30° N–50° N	160° W–125° W
Subtropical Northeast Pacific	ST NEP	10° N–30° N	180°–125° W
Northern Japan	N JP	40° N–50° N	115° E–170° E
Southern Japan	S JP	30° N–40° N	115° E–170° E
Northern India	N IND	20° N–30° N	60° E–90° E
Southern India	S IND	10° N–20° N	60° E–90° E
South China	S CHINA	5° N–25° N	90° E–130° E

Title Page

Abstract

Introduction

Conclusions

References

Tables

Figures

◀

▶

◀

▶

Back

Close

Full Screen / Esc

Printer-friendly Version

Interactive Discussion

Appendix A

Table A1. Number of GASP records in upper tropospheric regions (coordinate specification in Table 1) as function of season and year of observation.

Season	Number years	Number per Year					Number of records
		1975	1976	1977	1978	1979	
Atlantic (ATL)							
DJF	3	–	112	–	125	231	468
MAM	5	71	197	90	96	293	747
JJA	4	–	40	11	563	60	674
SON	3	–	304	37	578	–	919
Sum per year		71	653	138	1362	584	2808
Fraction (%)		2.5	23.3	4.9	48.5	20.8	
Europe (EUR)							
DJF	4	–	49	131	131	117	428
MAM	5	39	95	199	39	100	472
JJA	4	–	205	175	257	21	658
SON	3	–	75	142	381	–	598
Sum per year		39	424	647	808	238	2156
Fraction (%)		1.8	19.7	30.0	37.5	11.0	
Midlatitude Northeast Pacific (ML NEP)							
DJF	5	85	338	123	712	403	1661
MAM	5	238	577	447	863	272	2397
JJA	5	248	92	185	1575	79	2179
SON	4	174	157	221	1036	–	1588
Sum per year		745	1164	976	4186	754	7825
Fraction (%)		9.5	14.9	12.5	53.5	9.6	
Western USA (W USA)							
DJF	5	41	383	57	522	402	1405
MAM	5	161	460	184	653	156	1614
JJA	5	298	23	43	1957	26	2347
SON	4	257	115	66	1085	–	1523
Sum per year		757	981	350	4217	584	6889
Fraction (%)		11.0	14.2	5.1	61.2	8.5	
Northeastern USA (NE USA)							
DJF	5	9	104	4	197	182	496
MAM	5	65	264	121	197	173	795
JJA	5	34	46	14	609	37	740
SON	4	56	271	87	403	–	817
Sum per year		164	685	226	1381	392	2848
Fraction (%)		5.8	24.1	7.9	48.5	13.8	
Northern Japan (N JP)							
DJF	2	–	–	–	11	24	35
MAM	4	11	2	–	121	37	171
JJA	3	–	11	–	410	20	441
SON	3	–	153	49	101	–	303
Sum per year		11	166	49	643	81	950
Fraction (%)		1.2	17.5	5.2	67.7	8.5	

GASP ozone climatology of the nineteen seventies

C. Schnadt Poberaj et al.

Title Page

Abstract

Introduction

Conclusions

References

Tables

Figures

◀

▶

◀

▶

Back

Close

Full Screen / Esc

Printer-friendly Version

Interactive Discussion

Table A1. Continued.

Northern India (N IND)							
DJF	4	–	28	147	57	149	344
MAM	5	66	45	158	34	89	571
JJA	4	–	240	267	99	18	734
SON	3	–	22	76	139	–	751
Sum per year		66	335	648	329	256	1634
Fraction (%)		4.0	20.5	39.7	20.1	15.7	
Southern Japan (S JP)							
DJF	4	–	10	17	155	111	293
MAM	4	36	88	–	234	147	505
JJA	4	–	51	62	591	100	804
SON	3	–	195	85	355	–	635
Sum per year		36	344	164	1335	358	2237
Fraction (%)		1.6	15.4	7.3	59.7	16.0	
Southern India (S IND)							
DJF	3	–	–	208	6	13	227
MAM	2	–	–	101	–	12	113
JJA	3	–	145	178	5	–	328
SON	2	–	–	136	7	–	143
Sum per year			145	623	18	25	811
Fraction (%)			17.9	76.8	2.2	3.1	
Subtropical Northeast Pacific (ST NEP)							
DJF	5	71	842	346	1390	968	3617
MAM	5	402	725	718	1055	421	3321
JJA	5	379	167	427	2538	66	3577
SON	4	247	191	323	1148	–	1909
Sum per year		1099	1925	1814	6131	1455	12424
Fraction (%)		8.8	15.5	14.6	49.3	11.7	
South China (S CHINA)							
DJF	4	–	42	146	196	157	541
MAM	5	113	122	85	129	227	676
JJA	4	–	171	202	403	81	857
SON	4	–	33	144	363	–	540
Sum per year		113	368	577	1091	465	2614
Fraction (%)		4.3	14.1	22.1	41.7	17.8	

Title Page

Abstract

Introduction

Conclusions

References

Tables

Figures

◀

▶

◀

▶

Back

Close

Full Screen / Esc

Printer-friendly Version

Interactive Discussion

**GASP ozone
climatology of the
nineteen seventies**

C. Schnadt Poberaj et al.

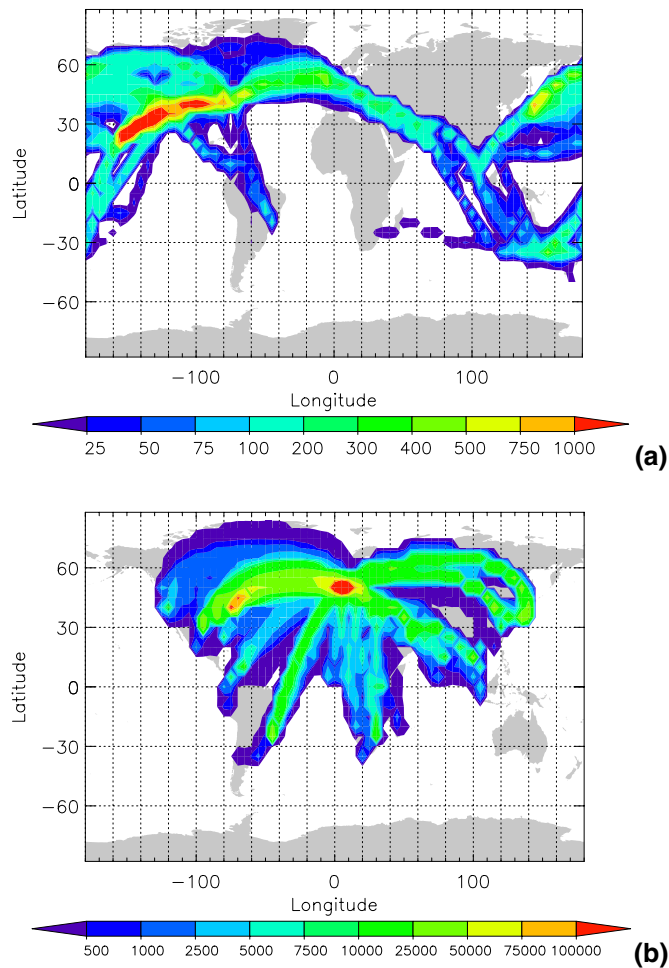

Fig. 1. Number of measurements and distribution of flight routes for the (a) GASP and (b) MOZAIC aircraft programs. Note the different colour scales for GASP and MOZAIC flight routes.

[Title Page](#)[Abstract](#)[Introduction](#)[Conclusions](#)[References](#)[Tables](#)[Figures](#)[◀](#)[▶](#)[◀](#)[▶](#)[Back](#)[Close](#)[Full Screen / Esc](#)[Printer-friendly Version](#)[Interactive Discussion](#)

GASP ozone climatology of the nineteen seventies

C. Schnadt Poberaj et al.

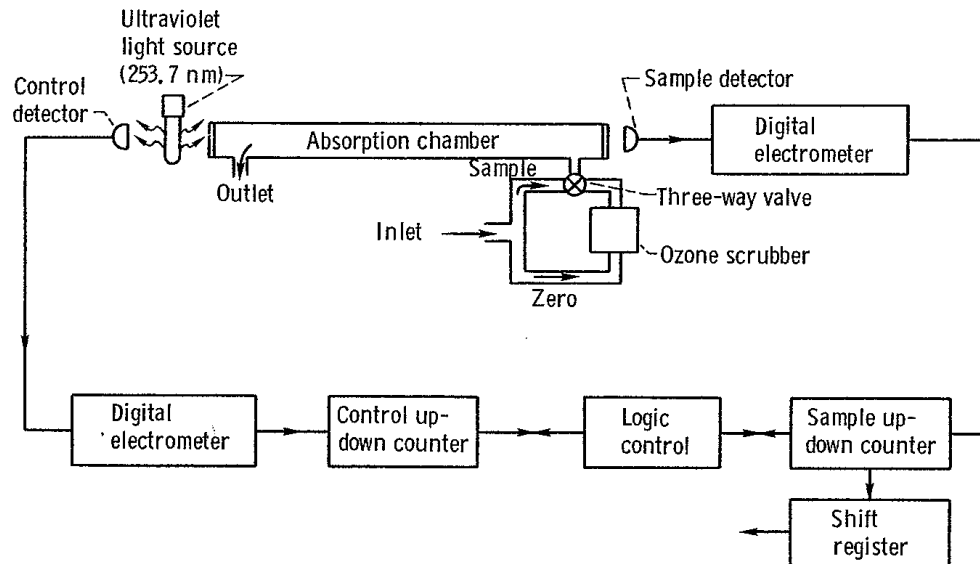

Fig. 2. GASP ozone-monitor block diagram. Adapted from Tiefermann (1979).

Title Page

Abstract

Introduction

Conclusions

References

Tables

Figures

◀

▶

◀

▶

Back

Close

Full Screen / Esc

Printer-friendly Version

Interactive Discussion

GASP ozone climatology of the nineteen seventies

C. Schnadt Poberaj et al.

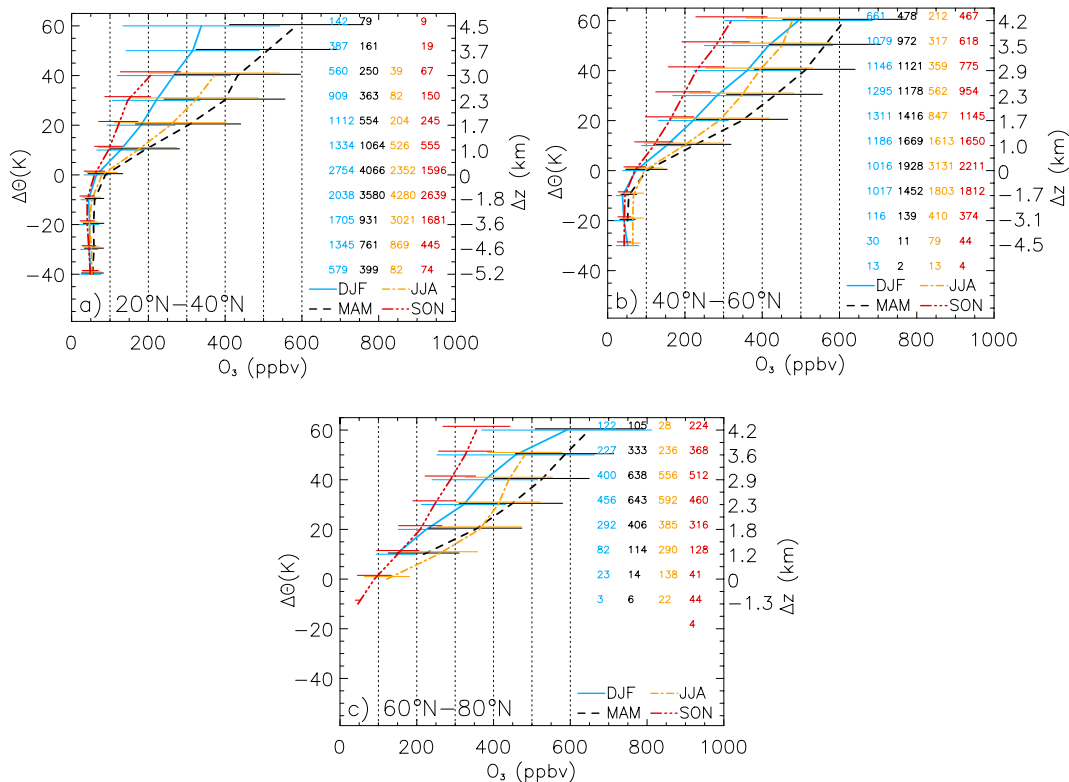

Fig. 3. Climatological mean ozone profiles for the GASP period 1975–1979 as function of potential temperature distance to the dynamical tropopause and season (DJF blue, MAM black, JJA orange, SON red). **(a)** 20°N–40°N, **(b)** 40°N–60°N, and **(c)** 60°N–80°N. Stratospheric profiles ($\Delta\theta > 0$ K) are filtered for equivalent latitudes for (b) and (c). Tropospheric ($\Delta\theta < 0$ K) and tropical stratospheric profiles are selected for geographical latitudes. Number of records per 10 K bin of $\Delta\theta$ and per season are given in the right part of the graphs (from left to right: DJF, MAM, JJA, SON).

Title Page

Abstract

Introduction

Conclusions

References

Tables

Figures

◀

▶

◀

▶

Back

Close

Full Screen / Esc

Printer-friendly Version

Interactive Discussion

GASP ozone climatology of the nineteen seventies

C. Schnadt Poberaj et al.

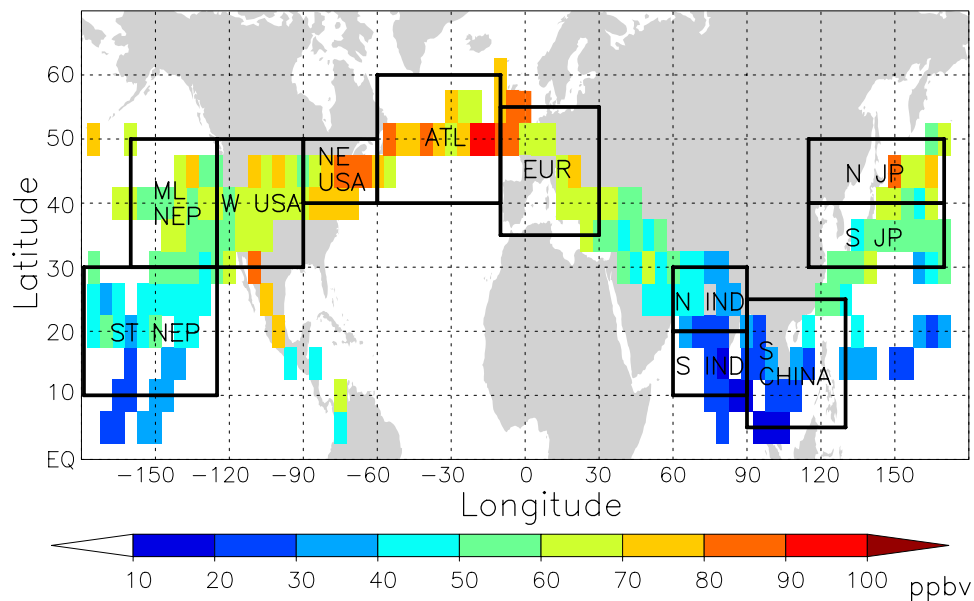

Fig. 4. Definition of regions for calculating regional means of upper tropospheric ozone. Colours: GASP climatological mean upper tropospheric ozone in JJA, $5^\circ \times 5^\circ$ averages. For detailed latitudinal/longitudinal specifications of regions see Table 4.

Title Page

Abstract

Introduction

Conclusions

References

Tables

Figures

◀

▶

◀

▶

Back

Close

Full Screen / Esc

Printer-friendly Version

Interactive Discussion

GASP ozone climatology of the nineteen seventies

C. Schnadt Poberaj et al.

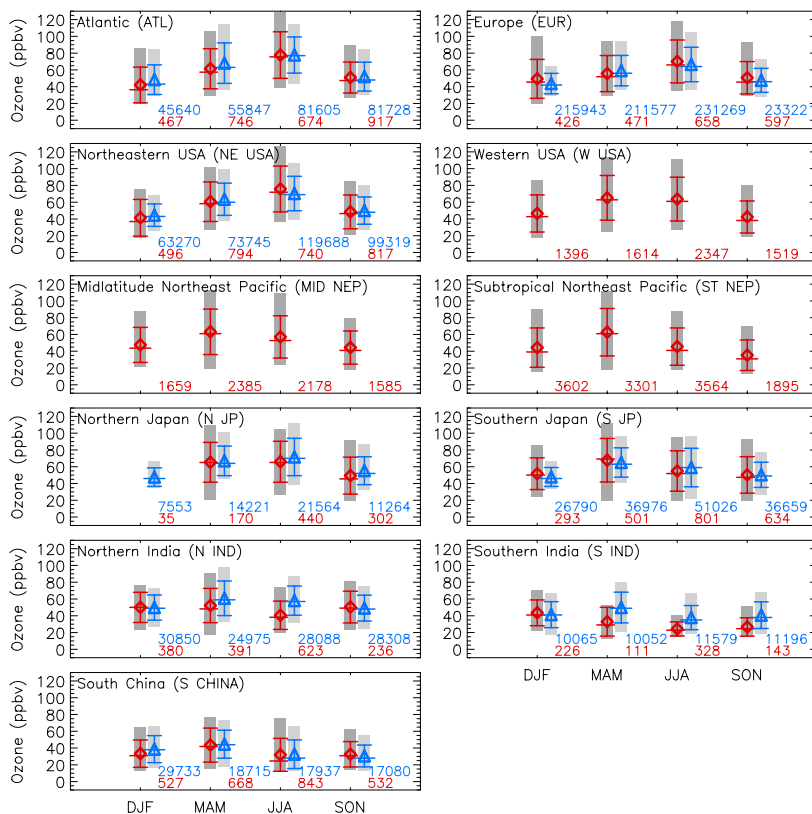

Fig. 5. Climatological mean and median ozone in the upper troposphere ($\Delta\theta < 0$ K) as a function of season for different regions of the world ordered as discussed in text (specifications of regions cf. Table 4). GASP means (medians) 1975–1979: red diamonds (horizontal bars), MOZAIC means (medians) 1994–2001: blue triangles (horizontal bars). Vertical grey boxes indicate central 90%. Numbers at the bottom give number of measurements in each region and season, black: GASP data, grey: MOZAIC data.

Title Page

Abstract

Introduction

Conclusions

References

Tables

Figures

◀

▶

◀

▶

Back

Close

Full Screen / Esc

Printer-friendly Version

Interactive Discussion

GASP ozone climatology of the nineteen seventies

C. Schnadt Poberaj et al.

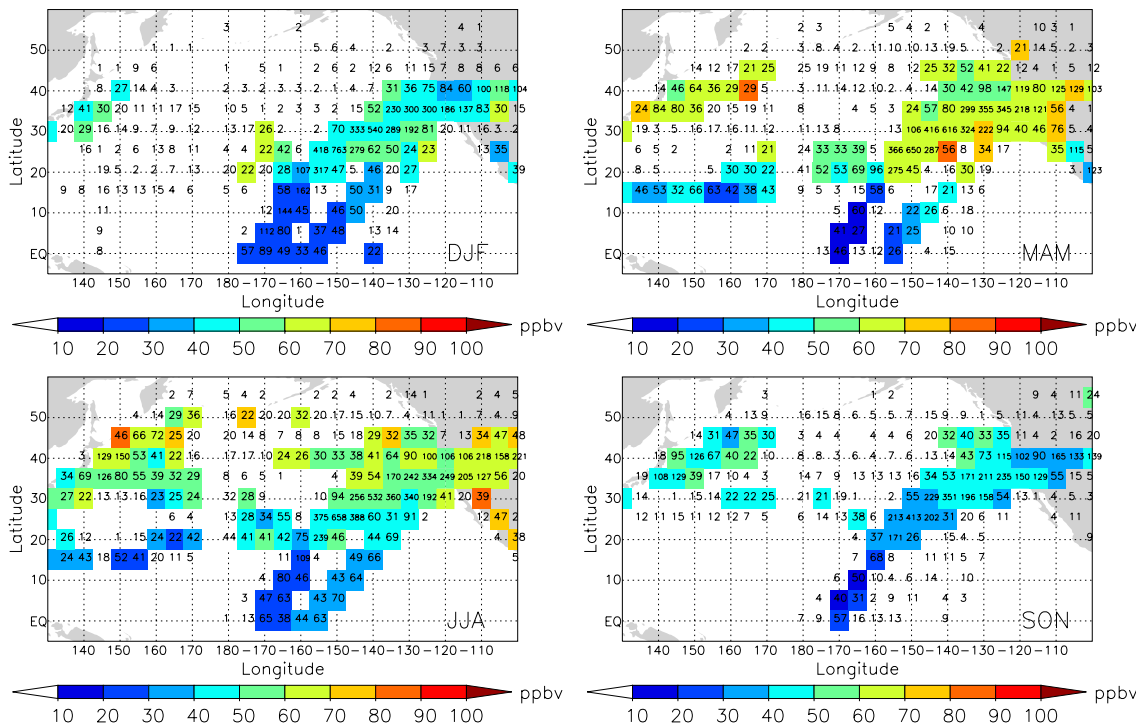

Fig. 6. Horizontal distribution of climatological mean upper tropospheric ozone ($\Delta\theta < 0$ K) (ppbv) over the Pacific region, from top to bottom: DJF, MAM, JJA, SON. Numbers indicate number of measurements in a $5^\circ \times 5^\circ$ box. Five-year averages are only displayed where number of measurements is larger than 20 in a box.

Title Page

Abstract

Introduction

Conclusions

References

Tables

Figures

◀

▶

◀

▶

Back

Close

Full Screen / Esc

Printer-friendly Version

Interactive Discussion

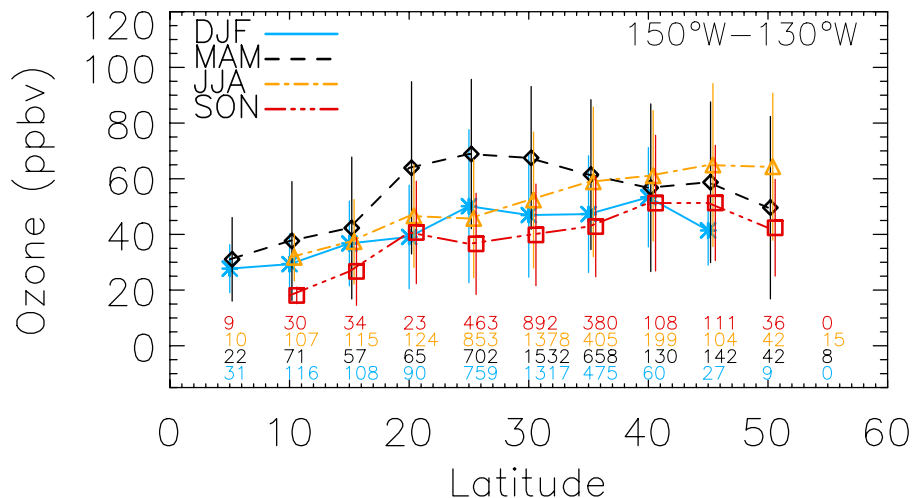

Fig. 7. Meridional cross section of mean upper tropospheric ozone ($\Delta\theta < 0\text{ K}$) (ppbv) for the longitude range 150° W to 130° W as function of season. Vertical bars denote standard deviation. DJF: blue solid line, asterisks, MAM: black dashed line, diamonds, JJA: orange dash-dot line, triangles, SON: red dash-dot-dot line, squares. Averages are only displayed when more than 20 records are available. Number of records at latitudes and over seasons are presented at the bottom, from DJF upward to SON.

GASP ozone climatology of the nineteen seventies

C. Schnadt Poberaj et al.

Title Page

Abstract

Introduction

Conclusions

References

Tables

Figures

◀

▶

◀

▶

Back

Close

Full Screen / Esc

Printer-friendly Version

Interactive Discussion

GASP ozone climatology of the nineteen seventies

C. Schnadt Poberaj et al.

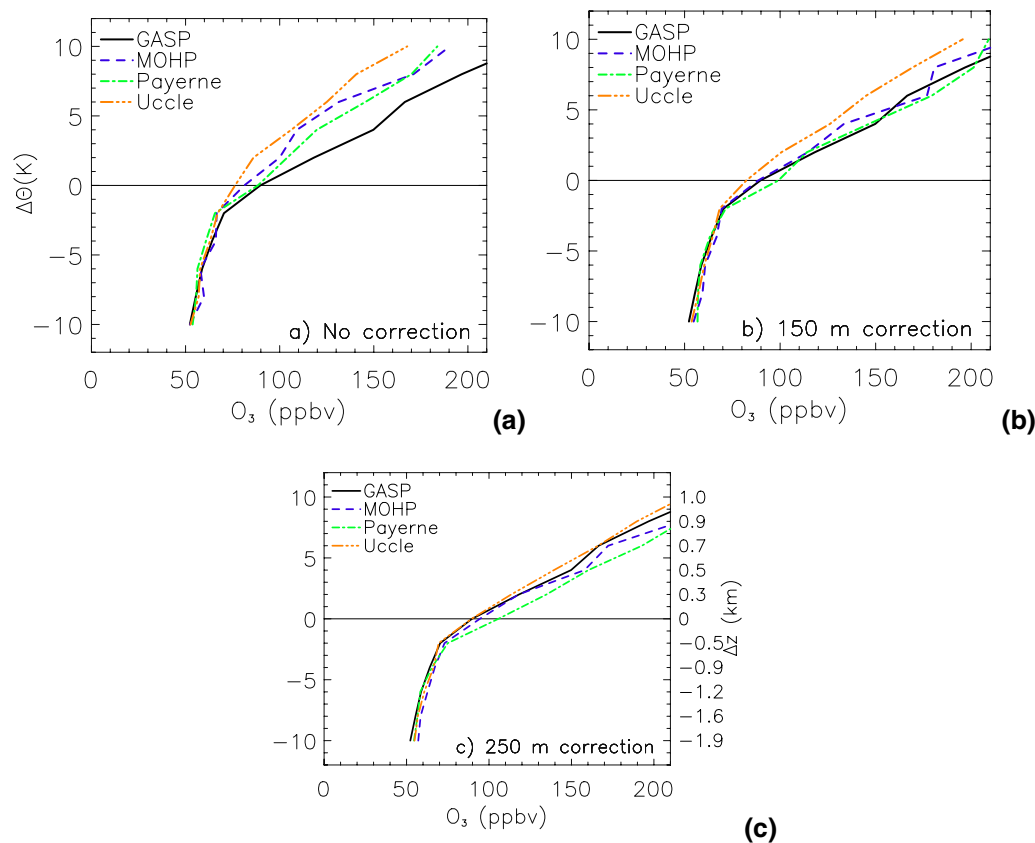

Fig. 8. Climatological GASP and ozonesonde spring ozone profiles averaged over 2 K bins within ± 10 K (≈ -2 km to $+1$ km) potential temperature distance around the tropopause for MAM. GASP black solid line, MOHP blue dashed line, Payerne green dash-dot-dotted line, and Uccle orange dash-dot-dotted line. **(a)** No correction applied, ozonesondes shifted by **(b)** 150 m and **(c)** 250 m downward.

Title Page

Abstract

Introduction

Conclusions

References

Tables

Figures

◀

▶

◀

▶

Back

Close

Full Screen / Esc

Printer-friendly Version

Interactive Discussion

GASP ozone climatology of the nineteen seventies

C. Schnadt Poberaj et al.

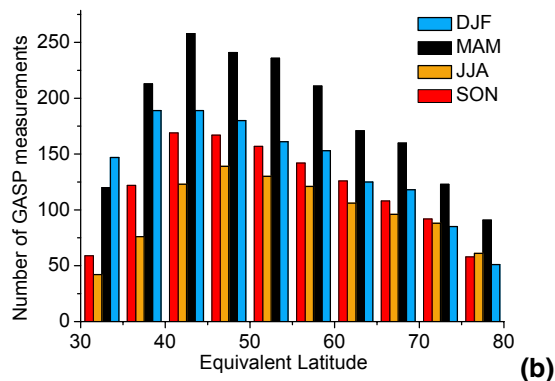
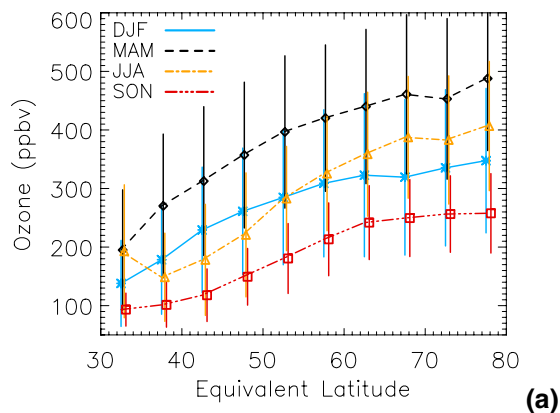

Fig. 9. (a) Climatological mean latitudinal distribution of lower stratospheric GASP ozone (5–50 K above the tropopause) (ppbv) as function of equivalent latitude and season. DJF (solid, blue), MAM (dashed, black), JJA (dashed-dot, orange), SON (dashed-dot-dot, red). Data are averaged over five degree bins. (b) Number of lower stratospheric GASP measurements at 5–50 K above the tropopause as function of equivalent latitude (five degree bins) and season. DJF (blue), MAM (black), JJA (orange), SON (red).

[Title Page](#)
[Abstract](#)
[Introduction](#)
[Conclusions](#)
[References](#)
[Tables](#)
[Figures](#)
[◀](#)
[▶](#)
[◀](#)
[▶](#)
[Back](#)
[Close](#)
[Full Screen / Esc](#)
[Printer-friendly Version](#)
[Interactive Discussion](#)

GASP ozone climatology of the nineteen seventies

C. Schnadt Poberaj et al.

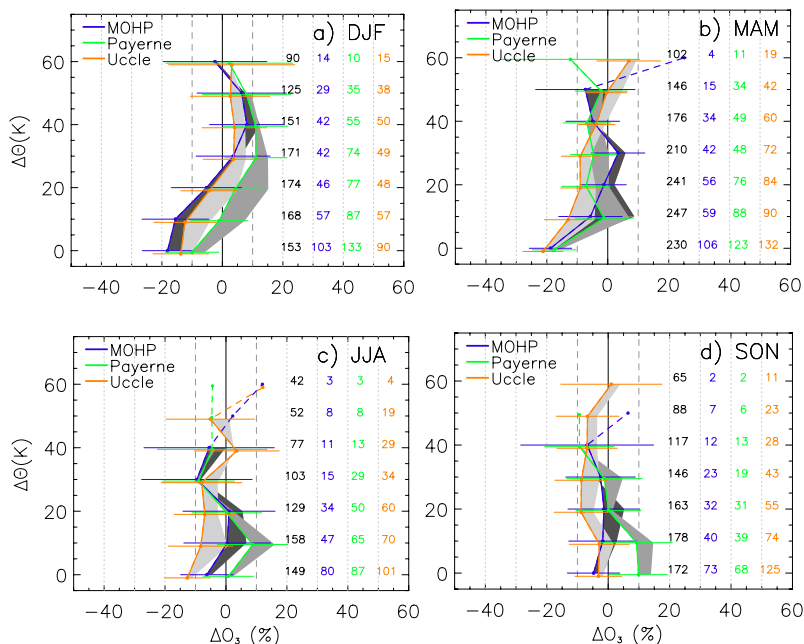

Fig. 10. Relative differences between averaged GASP and altitude corrected ozone sounding profiles (ozone soundings - GASP) as function of potential temperature distance from the tropopause for 40° N–60° N EL (in percent). Solid lines (MOHP: blue, Payerne: green, Uccle: red) indicate differences calculated from the 150 m-corrected profiles, horizontal bars denote the corresponding 95% confidence intervals. Shading represents uncertainty in aircraft-balloon differences due to given altitude correction with right limits of shading indicating differences calculated from 250 m-corrected profiles. Number of daily means of GASP (black) and soundings (coloured) are given in the right part of the plots as function of distance from the tropopause. Differences are only displayed using solid lines and shading if the number of daily means is greater equal ten. Otherwise the profile is indicated by dashed lines.

Title Page

Abstract

Introduction

Conclusions

References

Tables

Figures

◀

▶

◀

▶

Back

Close

Full Screen / Esc

Printer-friendly Version

Interactive Discussion

GASP ozone climatology of the nineteen seventies

C. Schnadt Poberaj et al.

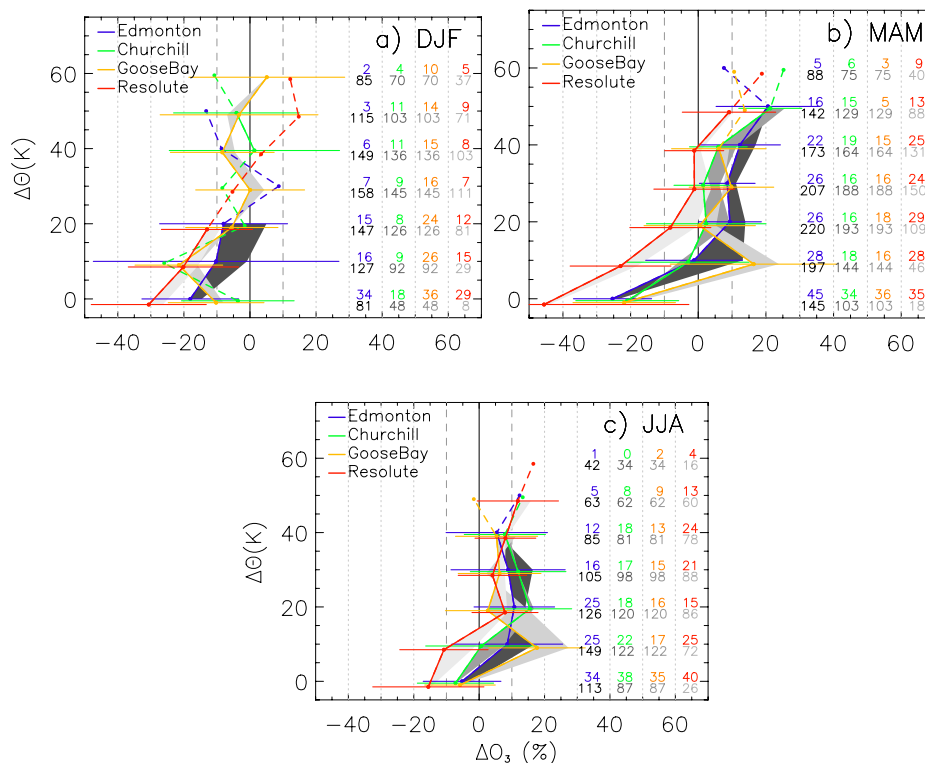

Fig. 11. As in Fig. 10, but for Canadian ozonesonde stations. GASP and ozonesonde data filtered for equivalent latitude range 45° N–65° N (Edmonton, blue line), 50° N–70° N (Churchill, green line; Goose Bay, yellow line), and 60° N–80° N (Resolute, red line). For each layer, numbers of sonde and GASP daily means are displayed in colour and grey, respectively. From left to right: Edmonton/45° N–65° N EL, Churchill/50° N–70° N EL, Goose Bay/50° N–70° N EL, Resolute/60° N–80° N EL.

Title Page

Abstract

Introduction

Conclusions

References

Tables

Figures

◀

▶

◀

▶

Back

Close

Full Screen / Esc

Printer-friendly Version

Interactive Discussion

GASP ozone climatology of the nineteen seventies

C. Schnadt Poberaj et al.

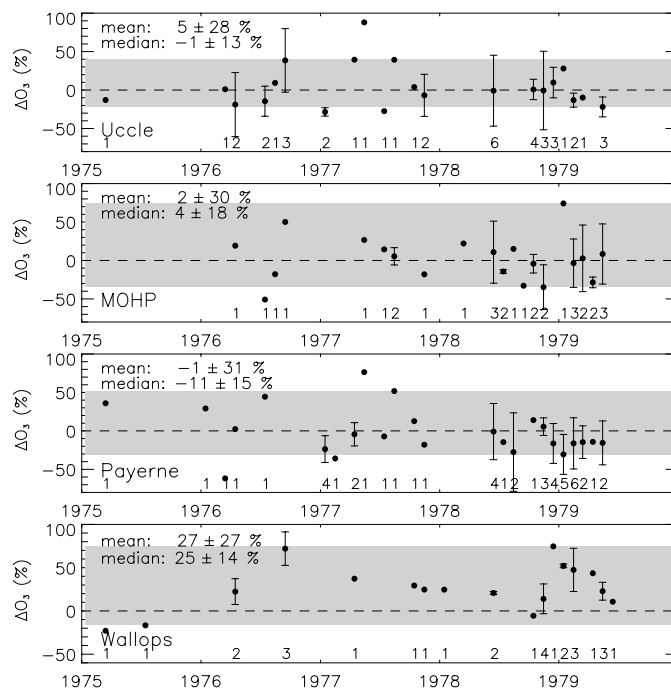

Fig. 12. Relative differences between quasi-monthly mean balloon and aircraft ozone in the UT ($\Delta\Theta < -2\text{K}$) for the period 1975–1979 (%). Comparison based on data from joint dates only. GASP ozone over Europe (Eastern USA) is evaluated against ozone at Uccle, MOHP, and Payerne (Wallops Island). Positive deviation indicates higher balloon than GASP ozone mixing ratio. Mean and median quasi-monthly mean differences are given in the upper left corners together with standard deviation and median absolute deviation, respectively. The range of the inner 90% is represented by the grey shading. Vertical bars denote standard deviation within a month if there is more than one concurrent date. At the bottom, the number of joint dates per month, from which quasi-monthly means and monthly standard deviations are calculated, is given for the period 1976–1979.

Title Page

Abstract

Introduction

Conclusions

References

Tables

Figures

◀

▶

◀

▶

Back

Close

Full Screen / Esc

Printer-friendly Version

Interactive Discussion