



HAL
open science

A reconstruction of the past trend of atmospheric CO based on firn air samples from Berkner Island, Antarctica

S. S. Assonov, C. A. M. Brenninkmeijer, P. Jöckel, R. Mulvaney, Serge
Bernard

► **To cite this version:**

S. S. Assonov, C. A. M. Brenninkmeijer, P. Jöckel, R. Mulvaney, Serge Bernard. A reconstruction of the past trend of atmospheric CO based on firn air samples from Berkner Island, Antarctica. *Atmospheric Chemistry and Physics Discussions*, 2005, 5 (5), pp.10259-10299. hal-00327978

HAL Id: hal-00327978

<https://hal.science/hal-00327978>

Submitted on 18 Jun 2008

HAL is a multi-disciplinary open access archive for the deposit and dissemination of scientific research documents, whether they are published or not. The documents may come from teaching and research institutions in France or abroad, or from public or private research centers.

L'archive ouverte pluridisciplinaire **HAL**, est destinée au dépôt et à la diffusion de documents scientifiques de niveau recherche, publiés ou non, émanant des établissements d'enseignement et de recherche français ou étrangers, des laboratoires publics ou privés.

A reconstruction of the past trend of atmospheric CO based on firn air samples from Berkner Island, Antarctica

S. S. Assonov¹, C. A. M. Brenninkmeijer¹, P. Jöckel¹, R. Mulvaney², and S. Bernard³

¹Max Planck Institute for Chemistry, Atmospheric Chemistry Department, P.O. Box 3060, 55020 Mainz, Germany

²British Antarctic Survey, High Cross, Madingley Road, Cambridge CB3 0ET, UK

³Laboratoire de Glaciologie et Géophysique de l'Environnement, 54 rue Molière – Domaine Universitaire – BP 96 – 38402 St Martin d'Hères Cedex, France

Received: 3 August 2005 – Accepted: 21 September 2005 – Published: 24 October 2005

Correspondence to: S. S. Assonov (assonov@mpch-mainz.mpg.de)

© 2005 Author(s). This work is licensed under a Creative Commons License.

A reconstruction of the past trend of atmospheric CO

S. S. Assonov et al.

Title Page

Abstract

Introduction

Conclusions

References

Tables

Figures

◀

▶

◀

▶

Back

Close

Full Screen / Esc

Print Version

Interactive Discussion

EGU

Abstract

Although for several atmospheric trace gases trends over the past 100 year have been reconstructed using firn air analyses, little is known about one of the chemically most significant trace gases, namely CO. Among the 3 Antarctic drilling expeditions reported, the one from Berkner Island appears to have given results of sufficient analytical quality to warrant a modelling with the aim to reconstruct past changes in atmospheric CO. Based on our reconstructions, CO in high latitudes of the Southern Hemisphere has been increasing since beginning of the 20th century from ~38 ppbv to a recent value of about 52.5 ppbv. The increase in CO is mainly explained by the known increase in CH₄, with biomass burning output being most likely responsible for an additional increase. Which, if any, role changes in OH have played cannot be derived.

1. Introduction

The reconstruction of past records for the atmospheric trace gases CO₂, CH₄ and N₂O is mainly based on the analysis of air extracted from firn and ice cores from the Arctic and Antarctic. All three gases have been increasing rapidly over the previous century mainly due to human activity. Because the oxidation of CH₄ is a main source of CO, especially in the southern hemisphere, it is expected that Southern Hemisphere (SH) CO also has been increasing.

However, little experimental information about past CO levels is available and in this sense, model scenarios concerning pre-historical levels of CO are just that. Haan and Raynaud (1998) have reported that SH CO has increased between 250 BC and 1900 AD from about 50 to 57 ppbv. For these analyses the CO concentration in small amounts of air (~7 ml) extracted from Antarctic ice cores samples had to be measured. These levels seem rather high compared to the modern mean of 48.6 ppbv measured by NOAA/CMDL in Antarctic (data available at <http://www.cmdl.noaa.gov/info/ftpdata.html>) and need verification. We are not aware of other reports on past CO

A reconstruction of the past trend of atmospheric CO

S. S. Assonov et al.

Title Page

Abstract

Introduction

Conclusions

References

Tables

Figures

◀

▶

◀

▶

Back

Close

Full Screen / Esc

Print Version

Interactive Discussion

**A reconstruction of
the past trend of
atmospheric CO**S. S. Assonov et al.

[Title Page](#)[Abstract](#)[Introduction](#)[Conclusions](#)[References](#)[Tables](#)[Figures](#)[◀](#)[▶](#)[◀](#)[▶](#)[Back](#)[Close](#)[Full Screen / Esc](#)[Print Version](#)[Interactive Discussion](#)

EGU

concentrations for the SH. The scarcity of data on CO may be due to its status as a non-greenhouse gas, but in reality accurate and precise measurements of CO in the ppbv range have proven to be rather difficult, even in the present atmosphere. We note that for instance the harmonization of CO scales is still an ongoing issue (c.f. Brenninkmeijer et al., 2001; Novelli, 1999; Novelli et al., 1998a, 2003). Nonetheless, it is very interesting and useful to know and understand past changes in CO because of its close link with CH₄ and of course OH, which is the troposphere's major self cleansing agent.

For several years we drilled in Antarctic firn and collected air samples with one of the objectives being to reconstruct past changes in CO. As the reader will find out below, in contrast to common firn air studies we have extracted large volumes of air, exceeding hundreds of liter. While the extraction and analysis of the very small ice core samples is extremely difficult, and the contamination free extraction of firn air is difficult, the scaling up to this degree brings it own problems. A main problem in firn air drilling is that most of the obtainable information of past trends in trace gases is contained in air residing near the pore close-off depth. Just here, the open porosity is small, which means that the permeability is small and consequently the resistance against pumping is high. This may lead to contamination of the air collected from these depths by air from shallower depths. Add to this that we sampled large amounts of air, the contamination-free compression of this air into high pressure storage cylinders poses an additional difficulty. One may well ask then why we did choose this difficult approach.

Our ambitious objective was to measure ¹⁴CO. This ultra trace gas (about 10 molecules per cm³ of air) is an ideal tracer for detecting changes in OH (Manning et al., 2005), and indeed if it were possible to reconstruct by firn air measurements past changes in ¹⁴CO, we would have information about the OH based oxidative capacity of the atmosphere that is otherwise not, or hardly obtainable. Yet, exactly this application requires very large samples of air. It is easy to see that about 1 million ¹⁴CO molecules have to be collected to obtain with a 1% detection efficiency a 1% Poisson statistical

error.

However, in this paper we will not report much on ^{14}CO , because unfortunately ^{14}CO appears to increase with sample depth in firn air due to the release of in situ produced ^{14}CO from the ice matrix into the firn air (Assonov et al., 2005). In other words, ^{14}CO in firn air not only reflects ^{14}CO in the original air, but also contains a contribution of ^{14}CO due to ^{14}C production by cosmic radiation in the firn ice matrix (for instance through spallation of ^{16}O nuclei, $^{16}\text{O}(n, 2p)n \rightarrow ^{14}\text{C}$ which gives ^{14}CO and $^{14}\text{CO}_2$, e.g. van de Wal et al., 1994), as this appears to leak from the solid phase into the gas phase. A true advantage of large samples then is that the stable isotopic composition of CO can be assayed. These stable isotope changes will beyond doubt help greatly to reconstruct and understand past changes in CO. Even though to date continuous flow isotope mass spectrometry has obviated the need for having large amounts of air available, at the beginning of our firn air sampling large samples were required for stable isotope analysis as well.

Facing an ugly fact of nature destroying the beautiful scientific hypothesis that using ^{14}CO can gauge past changes in OH, we decided to archive some of the sample material for $\Delta^{17}\text{O}$ analysis. In the past we have discovered that in the reaction of OH with CO, the ^{17}O content does not change as expected on the basis of the ^{18}O fractionation (Röckmann et al., 1998). This process of mass independent isotope fractionation leading to deviations in ^{17}O abundance due to the reaction with OH is potentially another – perhaps the only tracer – for providing information on past changes in OH. However, although we have developed 2 new techniques for mastering the $\Delta^{17}\text{O}$ analysis (Assonov and Brenninkmeijer, 2001; Brenninkmeijer and Röckmann, 1998), we must admit not yet having the possibility to reliably measure small samples (say the 20 μl of CO from 400 liter of air). In anticipation that such a method will be developed, we have archived some of the extracted CO samples as CO_2 , for later analysis for $\Delta^{17}\text{O}$. A consequence of all this is, and readers may find this out further along, that the number of samples we have analysed for ^{13}C and ^{18}O from the Berkner site is smaller than the total number of samples available. In other words, even though the more extensive

A reconstruction of the past trend of atmospheric CO

S. S. Assonov et al.

Title Page

Abstract

Introduction

Conclusions

References

Tables

Figures

◀

▶

◀

▶

Back

Close

Full Screen / Esc

Print Version

Interactive Discussion

analysis of ^{13}C and ^{18}O might have given us additional, useful information for carrying out the task described in this paper, we considered it wise to store some of the precious sample material for later carrying out $\Delta^{17}\text{O}$ analyses.

We further note that the interpretation of firn air records is not free from a range of assumptions. All reconstructions based on firn air measurements include various limitations due to the firn air model used, and the calibration thereof. Reconstructions of historical trends for the same gas being based on different firn profiles and performed by different groups (that means different approaches) may give significantly different trends. Thus, reconstructions obtained by Trudinger et al. (2004) for CH_3Br and CH_3Cl differ to various degrees from those by Butler et al. (1999), Aydin et al. (2004) and Kaspers et al. (2004). Noticeably, the error bands of all reconstructions are relatively large. We also note the inherent problems, namely the dating of firn samples, the range of ages covered and the use of an initial or a priori scenario. Concerning the latter problem – Trudinger et al. (2002) have used a Bayesian synthesis, namely the use of an a priori estimate of atmospheric trends by taking mixing ratios measured in firn and assigning them means of model age distribution. Next the optimization was carried out via an inversion synthesis by means of minimizing the sum of differences between model-generated values and observations as well as a difference from an a priori estimate. Such an algorithm appears to produce stable and robust reconstructions and is not sensitive to possible signal noise.

However, a broad range of sample ages is important for this approach and ideally little overlap. Because the mean age of our oldest CO sample is 1968 only, because the CO age distributions are relatively wide and overlap to a high degree and because of a lack of information on CO trends in the past, we used a compromise. We introduced one more constraint, linking a presumed year-to-year change of CO levels to the year-to-year changes of gases with known trends that are related to CO. These gases were CH_4 and CH_3Cl . First, we optimised this linkage to match CO observed in firn. As will be seen later, the two independent reconstructions produced very similar results, supporting our approach.

A reconstruction of the past trend of atmospheric CO

S. S. Assonov et al.

[Title Page](#)[Abstract](#)[Introduction](#)[Conclusions](#)[References](#)[Tables](#)[Figures](#)[◀](#)[▶](#)[◀](#)[▶](#)[Back](#)[Close](#)[Full Screen / Esc](#)[Print Version](#)[Interactive Discussion](#)

2. Sampling procedure and site description

Firn air samples were taken at three sites, namely Dronning Maud Land, Dome Concordia and Berkner Island (see Table 1, abbreviated DML, Dome C, and Berkner, respectively) during 3 firn air drilling expeditions within the framework of FIRETRACC (Firn REcord of Trace gases Relevant to Atmospheric Chemical Change) and CRYO-STAT (CRYOspheric STUDies of Atmospheric Trends in stratospherically and radiatively important gases). Details of the firn drilling, air sampling, and site descriptions are given in (Bräunlich et al., 2001; Mulvaney et al., 2002; Sturges et al., 2001a, b).

The basics of the firn air collection are depicted in Fig. 1. After drilling to a certain depth, the sampling device is lowered into the bore hole, leaving a “headspace” available at the bottom for withdrawing firn air. The inflatable cylindrical bladder is pressurized to form a seal against the wall of the borehole, after which air is withdrawn both from the upper compartment in the headspace through the upper inlet in the “Bender baffle” (via a 3/8 inch flushing line) and from the lower compartment through the lower inlet (via an 1/4 inch sampling line). The standard procedure is to withdraw air until the CO₂ concentration, measured in situ using a LICOR instrument, stabilises at a low level, indicating that younger contamination air has been pumped away. At this moment sampling starts. For standard size samples (sample flasks of several liter volume are filled at several bar pressure) sampled air is taken from the lower inlet while air is continuously withdrawn through the upper inlet (Fig. 1) and directed to waste. The reason for this is to withdraw air that may be contaminated with air from higher layers that has seeped along the bladder seal and/or by out-gassing of the rubber bladder material. For taking a small sample tens of liter of air are withdrawn. For taking large samples (500 l and some samples of 1000 l) substantially larger amounts of air are withdrawn, and the flushing line and the sampling line are shunted in parallel to minimize pumping resistance. This time the pumping system consists of a 2 stage metal bellows pump which feeds air into a modified Rix compressor (Mak and Brenninkmeijer, 1994). The pumping rate and thus filling time depends on the resistance at the drilling depth. It

A reconstruction of the past trend of atmospheric CO

S. S. Assonov et al.

Title Page

Abstract

Introduction

Conclusions

References

Tables

Figures

◀

▶

◀

▶

Back

Close

Full Screen / Esc

Print Version

Interactive Discussion

**A reconstruction of
the past trend of
atmospheric CO**S. S. Assonov et al.

[Title Page](#)[Abstract](#)[Introduction](#)[Conclusions](#)[References](#)[Tables](#)[Figures](#)[◀](#)[▶](#)[◀](#)[▶](#)[Back](#)[Close](#)[Full Screen / Esc](#)[Print Version](#)[Interactive Discussion](#)

EGU

is attempted to keep the pressure between the pump and compressor above ambient, because the Rix compressors, being based on sliding Teflon seals are not entirely leak tight against entraining ambient air. The air for the large air samples were dried using Drierite (basically CaSO_4) at a pressure of over 40 bar. After sampling at a given depth, the sampling device is raised from the borehole after which drilling to the next level takes place.

We note that sampling disturbs the existing firn air stratification in the vicinity of the sampling horizon. As a consequence, large samples may represent larger depth interval than small samples taken at the same depth and the data obtained on large samples may therefore differ from those obtained on small samples (Bräunlich et al., 2001). No specific data or calculations as to the actual depth interval sampled, or the 3-D shape of the “catchment” volume are available. At Berkner a strong porosity gradient with depth exists and the upward shift (a difference between actually sampled depths vs. a nominal drilling depth) appears to have a larger influence. A comparison of modelled CH_4 profile with observations implies that at depths from 49.99 to 58.88 m, shifts of up to 1.2 m are possible (Assonov et al., 2005). However, such a simplified evaluation of a depth bias is not problem-free as it is based on an adopted scenario and model calculations.

For the three sites of interest the calibration of the firn diffusivity profile was done by using CO_2 data obtained on small samples taken from the lower section of the Bender baffle. (That task was performed by LGGE team of the project.) The data for the large samples were not used for this calibration – firstly because the small samples provide a high resolution depth-coverage and secondly because of an unpredictable depth-bias of large samples. This bias, in fact resulting in air mixing from different depths, may affect the contents of different gases differently.

Concerning the problem of contamination of the sample air, the first potential source is CO production in the high pressure compressor. During the first campaign at DML, warming of the compressor was not controlled. At Dome C, the second expedition, due to low ambient pressure (this is an elevated site, see Table 1) it was difficult to

**A reconstruction of
the past trend of
atmospheric CO**S. S. Assonov et al.

[Title Page](#)[Abstract](#)[Introduction](#)[Conclusions](#)[References](#)[Tables](#)[Figures](#)[◀](#)[▶](#)[◀](#)[▶](#)[Back](#)[Close](#)[Full Screen / Esc](#)[Print Version](#)[Interactive Discussion](#)

EGU

fill cylinders near COD (Close-Off-Depth), and the compressor did warm up (as stated the samplings report) and was run for a prolonged time, thus unfavourably increasing the ratio of contamination to sample air. This explains high CO measured at Dome C near COD (Fig. 2). During the Berkner campaign, attention was paid to avoid compressor overloading. Moreover, two zero-air samples (ambient air passed through a CO destroying catalyst) were taken, one before and one after the firn drilling by using the same equipment and the same tubing (about 100 m). By this way a low value of the overall blank (including production in sampling cylinders) could be confirmed. A second source of contamination is formed by leakage in the high pressure compressor and/or between borehole and bladder walls. In fact, the first, low-pressure metal bellows compressor acts as a vacuum pump – sucking firn air through long tubing which causes an inlet pressure to be below ambient (Fig. 3). The pressure at the inlet of the second, high-pressure compressor could also be below ambient. This is a cause of concern because, as stated, the first stage of the 3 stage high pressure compressor is prone to entrain ambient air.

Because the same tubing was used to take zero air samples, and zero air samples have demonstrated low CO, all samples from low and middle depths where the pumping is similar to that for the zero tests are free of contamination. The situation with deepest samples might be different – inlet pressure of the first compressor decreased from ~ -0.4 bar for most samples to ~ -0.5 bar for samples taken at 57.89 to 58.88 m depth which reflects the increase in firn resistance to air movement. This appears to have caused certain leakage in the high-pressure compressor, resulting in contamination by the ambient air. To quantify the degree of leakage, we use SF₆ as tracer having a zero content in old firn air. The fact that SF₆ in the 58.88 m sample is higher than that in the 56.96 m sample (Fig. 4) evidently indicates leakage and gives us a quantitative estimate of this contamination being not more than 15%.

The trace gas separation was described in (Bräunlich et al., 2001; Brenninkmeijer, 1993; Brenninkmeijer et al., 2001). In essence, after removing CO₂ to sub ppbv levels, the CO content is oxidized to CO₂ followed by its cryogenic collection. The

**A reconstruction of
the past trend of
atmospheric CO**

S. S. Assonov et al.

Title Page

Abstract

Introduction

Conclusions

References

Tables

Figures

◀

▶

◀

▶

Back

Close

Full Screen / Esc

Print Version

Interactive Discussion

EGU

CO-oxidising reagent (I_2O_5 on a silicagel-support treated with H_2SO_4) preserves the original oxygen atom of CO so that $\delta^{18}O(CO)$ is obtained after an appropriate correction. After removing traces of H_2O , the amount of CO-derived CO_2 is determined volumetrically (Brenninkmeijer et al., 2001). This method is free from problems related to long-term stability of CO in high pressure cylinders (Novelli et al., 1998b; Novelli et al., 2003). This also implies that our CO scale may differ from that of NOAA/CMDL (see discussion). The random error of CO concentration measurements is 1%, and 1 St. Error = 1.1 ppbv was independently evaluated from the scatter of blank-uncorrected Berkner CO data (depths where there is no visible trend).

The samples were analysed by IRMS (Finnigan MAT 252, Bremen, Germany) to determine $\delta^{13}C(CO)$ and $\delta^{18}O(CO)$. Most samples from Dome C and DML and 3 samples from Berkner have been analysed for ^{14}CO (data plotted in Assonov et al., 2005). However, as mentioned in the introduction, the original ^{14}CO signals (^{14}CO from the ambient air) are found to be corrupted in various degrees by release of ^{14}CO produced by cosmic irradiation in the firn matrix. Two zero-air samples (ambient air passed through a catalyst that oxidizes CO) were taken at Berkner with the same compressor and the same tubing as used for sampling and yielded CO mixing ratios of 1.1 and 1.6 ppb. This means that the complete blank arising from the tubing, compressors and storage in the aluminium cylinders until the date of sample processing was very satisfactory. Because the amount of CO blank was extremely small, its $\delta^{13}C(CO)$ could not be measured. Based on previous expertise it is known that contamination from compressors shifts $\delta^{13}C(CO)$ in negative direction. Values of 1.33 ± 0.66 ppbv and $\delta^{13}C(CO) = -50 \pm 15\%$ (VPDB- CO_2) were used for blank-correction applied to the Berkner samples. Data obtained at DML and Dome C could not be blank corrected (no blank samples) and are not used for our calculations and conclusions.

3. Results – CO data

Figure 2 shows that the results obtained for the 3 sites are markedly different. CO values measured for DML and Dome C are higher and the accompanying isotope ratios for ^{13}C and ^{18}O show a more irregular pattern. Such differences, far away from surface sources of CO are not real, and by virtue of the zero air tests carried out at Berkner, it can be concluded that only these values reflect real atmospheric values. However, although the Berkner CO values are unaffected by contamination due to sampling and compressing, it appeared that based on SF_6 measured in one sample taken at 58.88 m maximally 15% contamination with ambient air had occurred. The important question is by how much such contamination shifts CO mixing ratios and in which direction. Let us consider the unfavourable case, namely that CO of the sample 58.88 m was affected by a 15%-dilution with ambient air having a lower CO level due to the strong seasonality of surface CO. In January, CO decreases rapidly. Measured at Berkner on 10 January 2003 it was 46.4 ppb, and on 29 January 2003 39.5 ppbv (before and after drilling). The two samples from 58.88 m were taken on 21 January 2003. Considering the lowest CO in the ambient air to be 39.5 ppbv (unfavourable case) we evaluate a possible negative bias to be up to 0.9 ppb. The estimated true values at 58.88 m (Table 1) are obtained by correcting the measured values for this shift, assuming the 15%-dilution has 50% uncertainty.

4. Modelling and discussion

4.1. Firn model and model age distributions for CO

The firn diffusion model (Rommelaere et al., 1997) was applied in the direct mode. This 1-dimensional model simulates gas phase diffusion and gravitational separation based on specified depth profiles of firn. Most important is the calibration of the diffusivity profile using CO_2 data obtained by the LGGE team as described in (Fabre et

A reconstruction of the past trend of atmospheric CO

S. S. Assonov et al.

Title Page

Abstract

Introduction

Conclusions

References

Tables

Figures

◀

▶

◀

▶

Back

Close

Full Screen / Esc

Print Version

Interactive Discussion

al., 2000). Namely, the profile is tuned to get the best agreement between model-generated CO₂ values (using known CO₂ atmospheric trend as model input) and the CO₂ signals measured on firn air samples. For this purpose, the small air samples taken from lower section in the baffle were used.

5 Testing of the model (mostly the CO₂ diffusivity profiles) for Dome C and DML was done using ¹⁴CO₂ and the model ¹⁴CO₂ profiles agree well with the measured ¹⁴CO₂ signals (Assonov et al., 2005). Also the CO₂ mixing ratios and δ¹³C(CO₂) show good agreement. For Berkner ¹⁴CO₂ was not measured, and the test was done by comparison of measured and modelled CH₄ signals (Assonov et al., 2005). CO₂ at Berkner
10 was found to be slightly contaminated by ~1 % (presumably by contamination of air within the drilling tent by breath), and therefore δ¹³C(CO₂) and CO₂ signals could not be used for such a test. At depths from 50 to 58.88 m, the model-generated CH₄ signals deviate from the measured ones. It is argued that the actual sampling depth is biased upwards relative to the nominal drilling depth which is likely due to taking large
15 samples. The deviations are from 0.1 m to 1.2 m, with the largest deviation for 53.95 m depth. If the nominal drilling depths were to be corrected for a depth bias estimated for CH₄ (Assonov et al., 2005), the modelled CO age distributions (see below) would shift slightly towards younger values. Because we are not able to better constrain a possible depth shift and/or a spatial distribution of the sampled air, we use the nominal
20 drilling depths for modelling purposes.

The model was used to generate CO age distributions being the response function $G(z, t)$ of an input atmospheric signal $a(t)$ for the depth z over a certain period of time. Age distributions for CO were modelled assuming zero trend of the input signal, with a time step of 1 year. A set of values $G(z, t)$ obtained for a given depth z (Fig. 5)
25 represents a distribution of gas portions (weights) vs. gas age t . The distributions obtained for depths less than 52 m start not from zero (Fig. 5) indicating that the weight of young air (younger than 1 y) cannot be presented explicitly; these distributions can be biased towards older air. The distributions obtained for several depths where the contribution of young air is small (52 m and below) bear the necessary information

A reconstruction of the past trend of atmospheric CO

S. S. Assonov et al.

[Title Page](#)[Abstract](#)[Introduction](#)[Conclusions](#)[References](#)[Tables](#)[Figures](#)[◀](#)[▶](#)[◀](#)[▶](#)[Back](#)[Close](#)[Full Screen / Esc](#)[Print Version](#)[Interactive Discussion](#)

required to reconstruct long-term atmospheric trends.

4.2. Constraining the CO atmospheric trend by using modelled age distributions

Trudinger et al. (2002) have given a detailed discussion on a reconstruction of atmospheric trends from firn air profiles. Because a trace gas (e.g. CO) at any given depth is a mixture of gas portions (weights) of different ages (age distribution), the gas concentration at this depth may be presented (Eq. 4 in Trudinger et al., 2002) as following:

$$c(z) = \sum_{t=\min}^N [G(z, t) * a(t)] \quad (1)$$

where $c(z)$ is the model-predicted concentration, $G(z, t)$ is the age distribution at the depth z and $a(t)$ is a tested concentration trend in the atmosphere. The value $t=\min$ corresponds to the time step (1 year in our case) used to construct $G(z, t)$, the value N corresponds to $G(z, N) \rightarrow 0$, which is 200y for Berkner (Fig. 5). Specifically, the distribution $G(z, t)$ is normalised so that $\sum_{t=1}^N G(z, t) \equiv 1$. Of course, some limits arise from the fact that the age distributions were modelled with a 1 year step.

To constrain an atmospheric trend $a(t)$ for a gas with unknown history, Trudinger et al. (2002) have minimised the objective function, namely a sum of differences between measured and modelled concentration signals and a term including a deviation from the prior estimate (a least-squares method). As an initial, a priori estimate Trudinger et al. (2002) used gas concentrations measured in firn, ascribing them means of model age distributions. As we noted in the introduction, this approach works well in case a substantial age range is covered by samples. That appears to be not the case for Berkner – the deepest, 58.88 m sample dates from 1968 (the mean age) only. Besides this, the age distributions of compounds analysed by Trudinger et al. (2002, 2004) at the DSSW20K are rather narrow and do not overlap each other to a high degree (see e.g. Fig. 2 in Trudinger et al., 2002, and Fig. 2 in Trudinger et al., 2004). In contrast,

A reconstruction of the past trend of atmospheric CO

S. S. Assonov et al.

Title Page

Abstract

Introduction

Conclusions

References

Tables

Figures

◀

▶

◀

▶

Back

Close

Full Screen / Esc

Print Version

Interactive Discussion

A reconstruction of the past trend of atmospheric CO

S. S. Assonov et al.

Title Page

Abstract

Introduction

Conclusions

References

Tables

Figures

◀

▶

◀

▶

Back

Close

Full Screen / Esc

Print Version

Interactive Discussion

EGU

the CO samples at Berkner have wide age distributions that do significantly overlap each other (Fig. 5). Thus, in the case of Berkner the use of this approach based on such an a priori estimate could not be stable. For the reasons above and because CO is a short-lived compound mostly produced by CH₄ oxidation and biomass burning (in the SH), we introduce a link between a year-to-year change in CO and that in CH₄ or CH₃Cl, see below.

Similar to Eq. (7) in Trudinger et al. (2002) we write the following:

$$\Psi = \sum_{z=\min}^{z=\max} [[CO(z) - \sum_{t=1}^N (G(z, t) * a(t))] / u_z]^2 \quad (2)$$

where u_z represents errors for the firm measurements, $z=\min$ corresponds to a depth where the weight of young gas (in the case of the 1-year step $G(z, t)$ that is one/two years old) is getting close to zero (for Berkner – 52.13 m and deeper) and $z=\max$ is a maximal measured depth. As we do not use a priori estimates, we eliminate the second term of Eq. (7) in (Trudinger et al., 2002) which relates to a deviation of a tested scenario from the prior estimate and errors of the latter.

By using Eq. (1) and minimizing Ψ in Eq. (2), the atmospheric trend $a(t)$ may be constrained based on measured $c(z)$ and modelled weights $G(z, t)$, i.e. without running the model. (That step may be done only for depths where the age distributions $G(z, t)$ modelled with a 1 year step become certain, in our case depths below 52 m, see above and Fig. 5). In this way, a family of atmospheric trends can be obtained which equally satisfy the criteria of Ψ being minimized (Eq. 2). Actually, the optimization was performed by changing the coefficient k_1 in Eq. (3) (a relationship factor between a year-to-year change in CO to that in CH₄) and the coefficient k_2 (a scaling factor between the CO scale of NOAA/CMDL and the scale of our laboratory; the factor required to introduce CO data from NOAA/CMDL in a consistent way). Finally, model runs based on selected atmospheric trends were performed, in order to visualize model generated values and to demonstrate a propagation of short term variations, e.g. seasonal cycle for depths below 52 m.

4.3. The attenuation of the CO seasonal cycle with depth and evaluation of the CO annual mean

In order to reconstruct the CO atmospheric trend, the influence of the seasonal variations has to be considered. The amplitude and phase of the CO seasonal cycle in the high latitudes of SH may be constrained using CO data obtained at three Antarctic stations (South Pole, Palmer and Syowa, NOAA/CMDL data archive at <http://www.cmdl.noaa.gov/info/ftpdata.html>, monthly means downloaded 5 July 2004). The three stations show nearly identical signals from 1994 to 2002 (Fig. 6). The amplitude of the CO seasonal cycle is 27% of the annual mean (the latter calculated from 1994 to 2002 is 48.6 ppbv on the NOAA/CMDL scale). We note the possible discrepancy between the NOAA/CMDL calibration and our calibration scale. Therefore we use the NOAA/CMDL data for a relative comparison – to evaluate the amplitude and phase of CO seasonal cycle, and year-to-year variations.

Having run the model with a series of scenarios (each scenario based on a zero atmospheric trend and a seasonal cycle being 27% of the annual mean, with each subsequent scenario shifted by one month), it was found that the CO seasonal cycle is effectively attenuated at a depth ~ 40 m and greater (Fig. 7). At these depths the residual of the annual cycle is $\sim 1/4$ of the CO determination error ($2\sigma = 1.3$ ppb). (This selection is arbitrary – simply because there are no samples between 19.94 m and 39.68 m.) Only CO signals below 39.68 m depth should be interpreted as records for the atmospheric trend. Thus, below 53.95 m depth, CO signals measured at Berkner show a consistent decrease (Fig. 2) which is evidence for lower CO levels in the past. From 47.93 to 53.95 m, measured CO signals show some scatter, without any clear trend (Table 1). In first instance, this range of depths may be used to evaluate an actual CO determination error ($2\sigma = 1.1$ ppb, blank-uncorrected CO values) as well as an annual CO mean in recent years. The signal averaged from 47.93 to 53.95 m is 50.7 ± 1.2 ppbv (blank-corrected CO values, 95% level). Values measured at 39.68 and 45.01 m show a negative excursion from this mean which in fact may indicate a relative

A reconstruction of the past trend of atmospheric CO

S. S. Assonov et al.

Title Page

Abstract

Introduction

Conclusions

References

Tables

Figures

◀

▶

◀

▶

Back

Close

Full Screen / Esc

Print Version

Interactive Discussion

**A reconstruction of
the past trend of
atmospheric CO**S. S. Assonov et al.

[Title Page](#)[Abstract](#)[Introduction](#)[Conclusions](#)[References](#)[Tables](#)[Figures](#)[◀](#)[▶](#)[◀](#)[▶](#)[Back](#)[Close](#)[Full Screen / Esc](#)[Print Version](#)[Interactive Discussion](#)

decrease of the recent year(s), being similar or maybe even more pronounced than that recorded at NOAA/CMDL stations in the year 2002 (Fig. 6). (The optimised families of CO reconstructions using the NOAA/CMDL observations appear to fail explaining these two samples, see below.) Next we note that because the contribution of different years to different depths is not equal and because CO in the past was lower, the annual mean for recent years should be evaluated only based on the reconstructed trends; the obtained mean of 50.7 ppbv may give an under-estimate of the actual value.

A question that needs to be briefly addressed is whether one can reconstruct the seasonal cycle of CO. Reconstruction of seasonal cycle for CH₃Cl and several NMHC based on firn air analyses and firn diffusion model was presented by Kaspers et al. (2004). In fact, these reconstructions have large error bands and reflect only the cycle in a year before sampling. Because CO in SH has a large seasonal cycle (Fig. 6) it would be of potential interest to get an accurate reconstruction of the CO seasonal cycle. However we argue that this task when based on a single firn profile at Berkner can be hardly solved. First, at high latitudes CO strongly decreases during summer (e.g. Novelli et al., 2003, see also Fig. 6). Thus, reconstructions based on firn samples taken in January would be extremely sensitive to the seasonal decrease. Indeed, during 2 weeks in January 2003, CO content in the ambient air at Berkner dropped from 46.4 ppbv to 39.5 ppbv (Table 1). Second, reconstructions of the seasonal cycle should be done with a time step much shorter than 1 month, taking into account actual sampling date for each sample. That is because seasonal changes in the atmosphere rapidly propagate to a few meter depth of firn. Third, one should consider wind and pressure-fluctuation pumping effects as well as thermo-diffusion in the upper meters of the firn (a well mixed zone may be of variable depth, depending on season). Besides, accurate calibration of diffusivity profile for upper 40 m depth – the depth affected by seasonal cycle – as well as an actual 3-D distribution of the area sampled by the large samples should be taken into account. This all renders reconstruction of CO seasonal cycle almost impossible.

A reconstruction of the past trend of atmospheric CO

S. S. Assonov et al.

Title Page

Abstract

Introduction

Conclusions

References

Tables

Figures

◀

▶

◀

▶

Back

Close

Full Screen / Esc

Print Version

Interactive Discussion

EGU

4.4. Reconstruction of the CO trend based on the trend of CH₄

We assume that changes of CO in the past have been proportional to the changes of other trace gases with known trend, namely CH₄ and CH₃Cl. These two gases both have natural sources and sources related to anthropogenic activity; CH₃Cl indirectly through biomass burning. There are clear reasons to use the past CH₄ trend as a proxy for CO:

1. oxidation of CH₄ is an important source of SH CO (Manning et al., 1997; Bergamaschi et al., 2000);
2. the atmospheric CH₄ trend is well known and methane nearly doubled during the 20th century (Etheridge et al., 1998);
3. the increase of CH₄ sources is mostly due to anthropogenic activity (e.g. Breas et al., 2001).

A possible complication comes from the fact that life-times of CO and CH₄ in the atmosphere are substantially different and these (mostly depending on atmospheric OH) might have been varied in the past. For this reason a ratio of CO and CH₄ in equilibrium could vary in some degree as well. However, we consider that as of a secondary importance.

The assumption that the year-to-year change of CH₄ was accompanied by a proportional change in CO may be written as follows:

$$[\text{CO}(t) - \text{CO}(t + 1)] = k_1 * [\text{CH}_4(t) - \text{CH}_4(t + 1)] \quad (3)$$

A CO scenario is then constructed as follows. Before 1994 when no CO measurements in Antarctic were performed, CO(*t*) is taken to be related to the known CH₄ trend (Fig. 8) by Eq. (3) in which the coefficient *k*₁ is taken as a variable. Seasonal variations are assumed to be absent prior to 1994. For the period prior to 1900 we assume a zero trend.

**A reconstruction of
the past trend of
atmospheric CO**

S. S. Assonov et al.

Title Page

Abstract

Introduction

Conclusions

References

Tables

Figures

◀

▶

◀

▶

Back

Close

Full Screen / Esc

Print Version

Interactive Discussion

EGU

Next, similar to Trudinger et al. (2002, 2004) we incorporate available atmospheric observations into the trend to be reconstructed. Because of a discrepancy between our CO scale and that of NOAA/CMDL (see above), we take the NOAA/CMDL data from 1994 to 2002 (Fig. 6) averaged over 3 stations with a scaling coefficient k_2 – that is the ratio of our laboratory scale relative to the CO scale of NOAA. This also gives us a realistic picture of seasonal variations. This scaling coefficient k_2 being another variable is then modified to get a best agreement.

The year 1993 where the CH₄-based part and the NOAA-based part (years 1994–2002) are connected is specific. As the CO life-time (about 2–3 months) is much shorter than that of CH₄ (about 10 y) and year-to-year changes in the CO life-time due to OH variations are possible (e.g. Manning et al., 2005), the value assigned to this year should represent a CH₄-based trend in general. CO in 1994 and 1995 appears to be elevated in comparison with subsequent years (Fig. 6), in contrast to the fact that in the 1990s the CH₄ increase slowed down and then levelled off (Dlugokencky et al., 2003). Instead of linking the year 1993 to the year 1994 by Eq. (3), for the year 1993 we take the mean of all the NOAA/CMDL data from 1994 to 2002 (Fig. 6) with the scaling coefficient k_2 .

CO atmospheric scenarios have been optimised by changing the two coefficients, k_1 and k_2 and minimizing the sum Ψ of differences (Eq. 2) between measured CO signals and those evaluated by using Eq. (1). That optimisation was done by numerical iterations. To smooth variations of CO measured from depths 52.13 m and 58.88 m (Table 1), we introduce the best-fit line for the observation points (Fig. 9, lower panel on the right). This line was used as a representative of the measured CO data. By varying the two coefficients we obtained the best scenario (Fig. 9, the right panel). The best scenario is obtained when assuming 52.5 ppbv ($k_2=1.08$) as a mean over 1994 to 2002 and ~38 ppbv for the early 1900s (Fig. 9). The coefficient k_1 corresponds to the CH₄-related CO source being ~55% for the present day CO burden. That value is in fact higher than 30% estimated for the modern CH₄-oxidation source in the SH (Manning et al., 1997) and higher than ~40% inferred for the modern CO at South

**A reconstruction of
the past trend of
atmospheric CO**

S. S. Assonov et al.

Title Page

Abstract

Introduction

Conclusions

References

Tables

Figures

◀

▶

◀

▶

Back

Close

Full Screen / Esc

Print Version

Interactive Discussion

EGU

Pole (Bergamaschi et al., 2000). Thus, the value of ~55% has a formal meaning and the CH₄ increase alone cannot explain the increase of CO; CO sources other than CH₄ oxidation must also have increased during the 20th century, with biomass burning being the most likely candidate.

To explore error envelopes of the reconstructed trend, a family of trend curves was obtained. First, the coefficient k_2 was varied so that the value for the mean from years 1994 to 2002 varied from 50.5 to 54 ppbv and second, the coefficient k_1 was additionally varied before the year 1968 (the mean age for the deepest sample). Because the contribution from years preceding 1968 is getting small, reconstructions for 1968 and beyond have a larger uncertainty.

To prove the validity of the CO trends reconstructed, they have being used as input for the firn diffusion model. The fact that model generated profiles deviate from the CO values predicted based on Eq. (1) by as little as 0.1 to 0.3 ppbv proves our constructions. These deviations might have arisen from the fact that the model runs used a 1-month step whereas the age distributions were obtained with a 1-year step and/or from numerical inaccuracy (due to rounding) of constructed $G(z, t)$.

Noticeably, both the CH₄-based reconstructions and CH₃Cl-based ones (see below) fail to explain the negative excursion of measured CO values at 45.01 and 47.93 m (Fig. 9 and Fig. 10). That deviation may in fact reflect a low value of CO in the year(s) preceding sampling or reflect an unrecognised problem. To quantitatively explain these deviations as well as CO measured at shallow depths, a CO seasonal cycle for the last few years should be known in detail. Alternatively, use of several firn profiles may help to constrain recent CO changes better.

4.5. Reconstruction of the CO trend based on the CH₃Cl trend

Another gas that may be used as a proxy for CO growth is CH₃Cl. We used a detailed reconstruction of the CH₃Cl trend given by Trudinger et al. (2004), assuming a zero trend before 1920. The CH₃Cl trend for 1920–2000 by Trudinger et al. (2004) is consistent with the reconstruction of Aydin et al. (2004). Similar to CO, CH₃Cl has

**A reconstruction of
the past trend of
atmospheric CO**S. S. Assonov et al.

[Title Page](#)[Abstract](#)[Introduction](#)[Conclusions](#)[References](#)[Tables](#)[Figures](#)[◀](#)[▶](#)[◀](#)[▶](#)[Back](#)[Close](#)[Full Screen / Esc](#)[Print Version](#)[Interactive Discussion](#)

EGU

both natural and anthropogenic sources, and the latter (mostly biomass burning) are discussed to have resulted in CH_3Cl increases during the 20th century. A difference compared to using CH_4 is that CH_3Cl has a shorter lifetime. Noteworthy the relationship between the CH_3Cl increase and biomass burning is not entirely clear – Aydin et al. (2004) reported a “sinusoidal” history of CH_3Cl , with two increases between 1720 and 1940. The reason of these fluctuations is not clear.

To construct a CO trend related to that of CH_3Cl , we have used the same approach as used for CH_4 . The obtained family of CO trends being presented on Fig. 10 is in fact very similar to the family based on the CH_4 trend (Fig. 9). The most likely mean in the years 1994 to 2002 is 52.5 ppb, the same as found for the CH_4 -based family of CO reconstructions. The most likely CO levels for the early 1900s are similar for the two families, being ~ 38 and ~ 37 ppbv respectively (Fig. 11).

4.6. Use of a proxy of CO trend – solution or additional problem?

One may ask why we need a proxy for the CO trend. CO age distributions at Berkner are rather wide and significantly overlap each other (Fig. 5), in contrast to the age distributions of CH_3Cl and CH_3Br (Trudinger et al., 2004). For this reason, inversion synthesis based on an a priori trend (the basic of the approach of Trudinger et al., 2002, 2004) could not be stable and robust. (As a priori estimate, Trudinger et al., 2002, used mixing ratios measured in firn assigning them means of model age distribution.) As the CO signals measured at Berkner have similar values of the age distribution means (Fig. 11) and the distributions significantly overlap each other (Fig. 5), such an a priori estimate would be rather uncertain. Some of the samples deviate from the two trends reconstructed in this study (Fig. 11), and they appear to have a none negligible contribution of lower CO in the past. We note that a width of an age distribution may serve as a certain indicator of a quality – the wider age distribution, the lower data quality and the lower the certainty of the atmospheric trend reconstruction.

Using methane as a proxy for CO appears to be reasonable – CO levels in the SH atmosphere directly relate to CH_4 (CH_4 oxidation), with the modern contributions

**A reconstruction of
the past trend of
atmospheric CO**

S. S. Assonov et al.

estimated to be from 30% (Manning et al., 1997) up to 40% (Bergamaschi et al., 2000). Given that both CH₄ and CO are destroyed by OH, possible variations in OH would give some variations of the CO lifetime (e.g. Manning et al., 2005), but these would be of second-order importance compared to the two-fold global increase of CH₄. To quantify the relationship between CH₄, CO and OH is beyond the scope of this reconstruction.

The use of CH₃Cl as a proxy explores the role of biomass burning, another source of CO that might have peaked recently. The fact that two reconstructions give two similar trends (Fig. 11) appears to prove our approach.

4.7. A comparison of our CO scale with the CO scale at NOAA/CMDL

Reliable and traceable calibration of CO scales is extremely important. The mean CO level of 52.5 ppbv obtained in two our reconstructions over 1994 to 2002 (Figs. 9 and 10) is higher than the average of 48.6 ppbv calculated for the same period using the NOAA/CMDL data at 3 Antarctic stations (Fig. 6). For optimal incorporation of the NOAA/CMDL data, these were scaled with the coefficient $k_2=1.08$. The observed discrepancy is in a reasonable agreement with previous inter-comparisons between our laboratory scale and that of NOAA/CMDL. Novelli et al. (2003) has noted that the upward time drift of CO standards is a serious analytical problem. The inter-comparison in 1993–1995 reported by these authors indicated that the CO content determined by absolute volumetric method corresponded to values on the revised NOAA/CMDL scale at ~50 ppbv level with a factor of ~1.04, and the revised NOAA/CMDL scale remains “on average 2–4 ppbv lower than the manometric measurements”. An inter-calibration test in 1998–1999 (Novelli et al., 2003) also demonstrated that the revised NOAA/CMDL scale is lower, with the same factor of 1.04 between the two scales. (Results of the later test reported by Brenninkmeijer et al. (2001) demonstrated that 51.8 ppbv on the absolute volumetric scale of the MPI-Chemistry corresponded to 45.0 ppbv on the NOAA/CMDL scale, the factor of ~1.15. However, the publication by Brenninkmeijer et al., 2001, preceded the NOAA/CMDL scale revision by Novelli et al., 2003). All the tests also indicated that the scale discrepancy being maximal at ~50 ppbv level is much

[Title Page](#)[Abstract](#)[Introduction](#)[Conclusions](#)[References](#)[Tables](#)[Figures](#)[◀](#)[▶](#)[◀](#)[▶](#)[Back](#)[Close](#)[Full Screen / Esc](#)[Print Version](#)[Interactive Discussion](#)

EGU

smaller at CO levels of 180 and 350 ppbv, in agreement with CO increase during storage discussed by (Novelli et al., 2003). All in all, the factor $k_2=1.08$ indirectly found in the present work is reasonable and indicates a calibration problem.

We also note that the calibration issue appears to be one of the possible reasons (besides background problems) why CO measured by Haan and Raynaud (1998) in Antarctic ice demonstrated a trend for 250 BC and 1900 AD from about 50 to 57 ppbv which is higher than our reconstructions for years 1900 to 2002 being from ~ 38 to 52.5 ppbv.

4.8. Reconstructing the $\delta^{13}\text{C}(\text{CO})$ trend and understanding other isotopes

Our reconstructions (Figs. 9 and 10) give evidence for a CO increase during the 20th century. Isotope variations in trace gases are well known to assist in better understanding source and sink processes, and for the precious firn air samples isotope analysis are considered useful. The important aspect of $\delta^{13}\text{C}(\text{CO})$ is that is a sensitive indicator for CO sources. However, it has to be borne in mind that the subtle isotope signals are affected by firn air processes, like gravitation effects and diffusion effects. Furthermore, the value of $\delta^{13}\text{C}(\text{CO})$ in firn is affected by the rapid CO growth in the atmosphere as the lighter molecule ^{12}CO diffuses faster downwards than ^{13}CO and thus $\delta^{13}\text{C}(\text{CO})$ is shifted in a negative direction. Running the model with the most likely CO scenario based on the CH_4 trend and CH_3Cl trend and a zero trend for $\delta^{13}\text{C}(\text{CO})$, the corrections of $\delta^{13}\text{C}(\text{CO})$ were evaluated. The largest correction is for the deepest sample, $\sim 0.7\text{‰}$. The corrected $\delta^{13}\text{C}(\text{CO})$ data show a weakly-constrained positive trend with depth (Fig. 12), implying isotopically heavier CO in the past. This agrees with our expectations – the contribution of isotopically light CO produced by CH_4 oxidation being 30% (Manning et al., 1997) or about 40% (Bergamaschi et al., 2000) for the modern CO burden in SH was lower in the past, by about 22 and 29%, respectively. (CH_4 is the most isotopically negative source of CO, e.g. Manning et al., 1997.) Although we cannot estimate the isotopic evolution of other CO sources, it is clear that $\delta^{13}\text{C}(\text{CH}_4)$ in the past was a few ‰ lower (Bräunlich et al., 2001; Craig et al., 1988; Sowers et

A reconstruction of the past trend of atmospheric CO

S. S. Assonov et al.

Title Page

Abstract

Introduction

Conclusions

References

Tables

Figures

◀

▶

◀

▶

Back

Close

Full Screen / Esc

Print Version

Interactive Discussion

al., 2005) relative to the modern value of $\sim -47\%$. This small effect must have been overridden by the lesser role CH_4 oxidation played as a CO source in the past.

The oxygen isotope composition of CO could shed light on the oxidative capacity in the atmosphere. All the samples at Berkner have low $\delta^{18}\text{O}(\text{CO})$ values which indicate high degree of CO degradation by OH. Indeed, the high SH latitudes are far away from direct CO sources (e.g. biomass and fossil fuel burning) having positive $\delta^{18}\text{O}(\text{CO})$ values. Still, the scarcity of $\delta^{18}\text{O}(\text{CO})$ data limits a present use. Because of concurrent changes in $\delta^{18}\text{O}(\text{CO})$ and $\Delta^{17}\text{O}(\text{CO})$ caused by OH (Röckmann et al., 1998), $\Delta^{17}\text{O}(\text{CO})$ is a promising tracer of the atmospheric oxidative capacity in the past. Thus although ^{14}C cannot be used (Assonov et al., 2005) we expect that $\delta^{18}\text{O}(\text{CO})$ and $\Delta^{17}\text{O}(\text{CO})$ analysed on CO extracted from ice cores may give invaluable information.

4.9. Possible firn based sources of CO

Chemical processes possibly affecting CO in firn air have to be considered. CO production due to photo-oxidation of VOC adsorbed on fresh snow has been found at Mt. Sonnblick, Austria (Haan et al., 2001) and photo-oxidation of formaldehyde was suggested as a primary CO source. For the high NH latitudes it has been proposed that formaldehyde is collected from polluted air by growing snow crystals, transported for a long distance from the polluted region to the area of precipitation and then released to the atmosphere during summer (e.g. Perrier et al., 2002; Sumner et al., 2002). Though air masses in the NH are more polluted than those in SH, the formaldehyde content in newly deposited Antarctic snow is up to 6 ppbw (Hutterli et al., 2002), with a sharp decline to 0.3–1.1 ppbw below 1 m depth.

Let us evaluate a possible CO production by photo-oxidation. Taking 5 ppbw of formaldehyde for the 30 cm firn depth at Berkner (30 cm is about a year accumulation) and assuming that all formaldehyde is photo-oxidised in firn (the latter agrees well with the photolysis rate of $3.3 \cdot 10^{-5} \text{ s}^{-1}$, e.g. Haan et al., 2001, and references therein), a total of ~ 2300 ppbv of CO would be produced within the upper 30 cm firn if the firn ventilation were zero. However, the upper firn is extremely well ventilated by

A reconstruction of the past trend of atmospheric CO

S. S. Assonov et al.

Title Page

Abstract

Introduction

Conclusions

References

Tables

Figures

◀

▶

◀

▶

Back

Close

Full Screen / Esc

Print Version

Interactive Discussion

**A reconstruction of
the past trend of
atmospheric CO**S. S. Assonov et al.

[Title Page](#)[Abstract](#)[Introduction](#)[Conclusions](#)[References](#)[Tables](#)[Figures](#)[◀](#)[▶](#)[◀](#)[▶](#)[Back](#)[Close](#)[Full Screen / Esc](#)[Print Version](#)[Interactive Discussion](#)

EGU

wind and pressure drops resulting from a rugged snow surface (“zastrugi”). The vertical air velocity estimated for ~30 cm depth at Siple Dome is up to 0.1 to 0.5 mm s⁻¹ (Albert, 2002) with similar values given by Neumann and Waddington (2004). Assuming a vertical air velocity of 0.1 mm s⁻¹, the 30 cm depth zone will be ventilated in ~1 h, or ~2900 times in 4 months. In other words, if photo-oxidation of formaldehyde were completely in situ, it would elevate CO in the upper 30 cm firn for less than 1 ppbv. In fact, a significant part of adsorbed formaldehyde is removed to the atmosphere without being photo-oxidised in firn (Hutterli et al., 2004).

All in all, we consider in situ photochemical CO production to be negligible. Alternatively, to better constrain the effect of CO production by photo-oxidation of adsorbed VOC, one should study several firn sites with different accumulation rates, different age distributions and different regimes of firn ventilation. Obviously, firn sites in the NH where amount of adsorbed organics is much higher are less suitable for CO reconstructions.

5. Summary and outlook

CO concentrations and isotope ratios in firn air samples from Berkner Island (Antarctic) taken in January 2003 have been measured. As these samples were found to be free from relevant contamination, the data were used to reconstruct the CO atmospheric trend in the high latitudes of the Southern Hemisphere. The most likely reconstruction corresponds to a CO increase from ~38 ppbv in 1900 to the level of 52.5 ppbv in the years 1994 to 2002. The fact that the latter value differs from the mean of 48.6 ppbv for NOAA/CMDL measurements in Antarctic for the same years reflects a persisting calibration problem. As all measurements of firn air at Berkner were performed on the same scale and with low value of overall blank, our conclusion on CO increase is beyond doubt.

CO age distributions at Berkner are broad and significantly overlap each other. Therefore, to reconstruct CO atmospheric history we considered a proxy of CO trend.

A reconstruction of the past trend of atmospheric CO

S. S. Assonov et al.

Title Page

Abstract

Introduction

Conclusions

References

Tables

Figures

◀

▶

◀

▶

Back

Close

Full Screen / Esc

Print Version

Interactive Discussion

EGU

As such a proxy we have used the well-known trend of methane. Methane oxidation is one of the important CO sources and the methane increase during the 20th century may be used as an approximate of anthropogenic CO-emission processes such as fossil fuel burning and biomass burning. These CO sources also have increased.

5 CH₃Cl was used as another proxy because the CH₃Cl increase is taken to be due to biomass burning. The CO reconstruction being based on the atmospheric CH₃Cl trend is very similar to the one based on the methane trend. To reconstruct the CO atmospheric trend better, its seasonal cycle should be accurately known at least for one year preceding firn air sampling. Besides this, to constrain or eliminate the effect of CO
10 production by VOC photo-oxidation, several firn sites are to be studied. The $\delta^{13}\text{C}(\text{CO})$ data obtained for Berkner Island suggest that CO was isotopically heavier in the past, in agreement with a lower contribution of methane oxidation in the past.

We finally conclude that our work gives a reasonably reliable picture of a SH increase in CO, and leaves a room for improvements, including the use of isotopes.

15 *Acknowledgements.* I. Levin kindly helped us with accurate SF₆ measurements. We thank the FIRETRACC and CRYOSTAT firn drilling expeditions in Antarctica for taking the samples and the LGGE team of the FIRETRACC and CRYOSTAT for calibrating firn diffusivity profiles. C. Koepfel kindly helped us by maintaining and running the CO extraction line. This work is a contribution to the European Commission project CRYOSTAT (EVK2-CT2001-ss00116)
20 funded under the Energy, Environment and Sustainable Development Programme, 1998–2002; S. Assonov acknowledges participation in the project.

References

- Albert, M. R.: Effects of snow and firn ventilation on sublimation rates, *Ann. Glaciol.*, 35, 52–56, 2002.
- 25 Assonov, S. S. and Brenninkmeijer, C. A. M.: A new method to determine the ¹⁷O isotopic abundance in CO₂ using oxygen isotope exchange with a solid oxide, *Rapid Commun. Mass Spectrom.*, 15, 2426–2437, 2001.

**A reconstruction of
the past trend of
atmospheric CO**S. S. Assonov et al.

[Title Page](#)[Abstract](#)[Introduction](#)[Conclusions](#)[References](#)[Tables](#)[Figures](#)[◀](#)[▶](#)[◀](#)[▶](#)[Back](#)[Close](#)[Full Screen / Esc](#)[Print Version](#)[Interactive Discussion](#)

Assonov, S. S., Brenninkmeijer, C. A. M., and Jöckel, P.: The ^{18}O isotope exchange rate between firn air CO_2 and the firn matrix at three Antarctic sites, *J. Geophys. Res.-Atmos.*, 110(D18), D18310, doi:10.1029/2005JD005769, 2005.

Aydin, M., Saltzman, E. S., De Bruyn, W. J., Montzka, S. A., Butler, J. H., and Battle, M.: Atmospheric variability of methyl chloride during the last 300 years from an Antarctic ice core and firn air, *Geophys. Res. Lett.*, 21(2), L02109, doi:10.1029/2003GL018750, 2004.

Bergamaschi, P., Hein, R., Heimann, M., and Crutzen, P. J.: Inverse modeling of the global CO cycle 1. Inversion of CO mixing ratios, *J. Geophys. Res.-Atmos.*, 105, 1909–1927, 2000.

Bräunlich, M., Aballain, O., Marik, T., et al.: Changes in the global atmospheric methane budget over the last decades inferred from ^{13}C and D isotopic analysis of Antarctic firn air, *J. Geophys. Res.-Atmos.*, 106(D17), 20465–20481, 2001.

Breas, O., Guillou, C., Reniero, F., and Wada, E.: The global methane cycle: Isotopes and mixing ratios, sources and sinks, *Isotopes Environ. Health Stud.*, 37, 257–379, 2001.

Brenninkmeijer, C. A. M.: Measurement of the abundance of ^{14}CO in the atmosphere and the $^{13}\text{C}/^{12}\text{C}$ and $^{18}\text{O}/^{16}\text{O}$ ratio of atmospheric CO with applications in New-Zealand and Antarctica, *J. Geophys. Res.-Atmos.*, 98, 10595–10614, 1993.

Brenninkmeijer, C. A. M., Koepfel, C., Röckmann, T., Scharffe, D. S., Bräunlich, M., and Gros, V.: Absolute measurement of the abundance of atmospheric carbon monoxide, *J. Geophys. Res.-Atmos.*, 106, 10003–10010, 2001.

Brenninkmeijer, C. A. M. and Röckmann, T.: A rapid method for the preparation of O_2 from CO_2 for mass spectrometric measurement of $^{17}\text{O}/^{16}\text{O}$ ratios, *Rapid Commun. Mass Spectrom.*, 12, 479–483, 1998.

Butler, J. H., Battle, M., Bender, M. L., et al.: A record of atmospheric halocarbons during the twentieth century from polar firn air, *Nature*, 399, 749–755, 1999.

Craig, H., Chou, C. C., Welhan, J. A., Stevens, C. M., and Engelkemeir, A.: The isotopic composition of methane in polar ice cores, *Science*, 242, 1535–1539, 1988.

Etheridge, D. M., Steele, L. P., Francey, R. J., and Langenfelds, R. L.: Atmospheric methane between 1000 AD and present: Evidence of anthropogenic emissions and climatic variability, *J. Geophys. Res.-Atmos.*, 103, 15979–15993, 1998.

Dlugokencky, E. J., Houweling, S., Bruhwiler, L., et al.: Atmospheric methane levels off: Temporary pause or a new steady-state?, *Geophys. Res. Lett.*, 30, doi:10.1029/2003GL018126, 2003.

**A reconstruction of
the past trend of
atmospheric CO**S. S. Assonov et al.

[Title Page](#)[Abstract](#)[Introduction](#)[Conclusions](#)[References](#)[Tables](#)[Figures](#)[◀](#)[▶](#)[◀](#)[▶](#)[Back](#)[Close](#)[Full Screen / Esc](#)[Print Version](#)[Interactive Discussion](#)

Fabre, A., Barnola, J. M., Arnaud, L., and Chappellaz, J.: Determination of gas diffusivity in polar firn: Comparison between experimental measurements and inverse modeling, *Geophys. Res. Lett.*, 27, 557–560, 2000.

Haan, D. and Raynaud, D.: Ice core record of CO variations during the last two millennia: atmospheric implications and chemical interactions within the Greenland ice, *Tellus Ser. B*, 50, 253–262, 1998.

Haan, D., Zuo, Y., Gros, V., and Brenninkmeijer, C. A. M.: Photochemical production of carbon monoxide in snow, *J. Atmos. Chem.*, 40, 217–230, 2001.

Hutterli, M. A., Bales, R. C., McConnell, J. R., and Stewart, R. W.: HCHO in Antarctic snow: Preservation in ice cores and air-snow exchange, *Geophys. Res. Lett.*, 29, 76-1–76-4, 2002.

Hutterli, M. A., McConnell, J. R., Chen, G., Bales, R. C., Davis, D. D., and Lenschow, D. H.: Formaldehyde and hydrogen peroxide in air, snow and interstitial air at South Pole, *Atmos. Environ.*, 38, 5439–5450, 2004.

Kaspers, K. A., van de Wal, R. S. W., and de Gouw, J. A.: Seasonal cycles of nonmethane hydrocarbons and methyl chloride, as derived from firn air from Dronning Maud Land, Antarctica, *J. Geophys. Res.-Atmos.*, 109, D02307, doi:10.1029/2003JD003950, 2004.

Mak, J. E. and Brenninkmeijer, C. A. M.: Compressed-air sample technology for isotopic analysis of atmospheric carbon-monoxide, *J. Atmos. Oceanic Technol.*, 11, 425–431, 1994.

Manning, M. R., Brenninkmeijer, C. A. M., and Allan, W.: Atmospheric carbon monoxide budget of the southern hemisphere: Implications of $^{13}\text{C}/^{12}\text{C}$ measurements, *J. Geophys. Res.-Atmos.*, 102, 10 673–10 682, 1997.

Manning, M. R., Lowe, D. C., Moss, R. C., Bodeker, G. E., and Allan, W.: Short term variations in the oxidising power of the atmosphere, *Nature*, 436, 1001–1004, 2005.

Mulvaney, R., Oerter, H., Peel, D. A., et al.: 1000 year ice-core records from Berkner Island, Antarctica, *Ann. Glaciol.*, 35, 45–51, 2002.

Neumann, T. A. and Waddington, E. D.: Effects of firn ventilation on isotopic exchange, *J. Glaciology*, 50, 183–194, 2004.

Novelli, P. C.: CO in the atmosphere: measurement techniques and related issues, *Chemosphere – Global Change Science*, 1, 115–126, 1999.

Novelli, P. C., Connors, V. S., Reichle, H. G., et al.: An internally consistent set of globally distributed atmospheric carbon monoxide mixing ratios developed using results from an intercomparison of measurements, *J. Geophys. Res.-Atmos.*, 103, 19 285–19 293, 1998a.

Novelli, P. C., Masarie, K. A., and Lang, P. M.: Distributions and recent changes of carbon

**A reconstruction of
the past trend of
atmospheric CO**S. S. Assonov et al.

[Title Page](#)[Abstract](#)[Introduction](#)[Conclusions](#)[References](#)[Tables](#)[Figures](#)[◀](#)[▶](#)[◀](#)[▶](#)[Back](#)[Close](#)[Full Screen / Esc](#)[Print Version](#)[Interactive Discussion](#)

EGU

- monoxide in the lower troposphere, *J. Geophys. Res.-Atmos.*, 103, 19 015–19 033, 1998b.
- Novelli, P. C., Masarie, K. A., Lang, P. M., Hall, B. D., Myers, R. C., and Elkins, J. W.: Reanalysis of tropospheric CO trends: Effects of the 1997–1998 wildfires, *J. Geophys. Res.-Atmos.*, 108, 4464, doi:10.1029/2002JD003031, 2003.
- 5 Perrier, S., Houdier, S., Domine, F., et al.: Formaldehyde in Arctic snow. Incorporation into ice particles and evolution in the snowpack, *Atmos. Environ.*, 36, 2695–2705, 2002.
- Röckmann, T., Brenninkmeijer, C. A. M., Saueressig, G., et al.: Mass-independent oxygen isotope fractionation in atmospheric CO as a result of the reaction CO+OH, *Science*, 281, 544–546, 1998.
- 10 Rommelaere, V., Arnaud, L., and Barnola, J. M.: Reconstructing recent atmospheric trace gas concentrations from polar firn and bubbly ice data by inverse methods, *J. Geophys. Res.-Atmos.*, 102, 30 069–30 083, 1997.
- Sowers, T., Bernard, S., Aballain, O., Chappellaz, J., Barnola, J.-M., and Marik, T.: Records of the $\delta^{13}\text{C}$ of atmospheric CH_4 over the last 2 centuries as recorded in Antarctic snow and ice, *Global Biogeochem. Cycles*, 19, GB2002, doi:10.1029/2004GB002408, 2005.
- 15 Sturges, W. T., McIntyre, H. P., Penkett, S. A., et al.: Methyl bromide, other brominated methanes, and methyl iodide in polar firn air, *J. Geophys. Res.-Atmos.*, 106, 1595–1606, 2001a.
- Sturges, W. T., Penkett, S. A., Barnola, J. M., Chappellaz, J., Atlas, E., and Stroud, V.: A long-term record of carbonyl sulfide (COS) in two hemispheres from firn air measurements, *Geophys. Res. Lett.*, 28, 4095–4098, 2001b.
- Sumner, A. L., Shepson, P. B., Grannas, A. M., et al.: Atmospheric chemistry of formaldehyde in the Arctic troposphere at Polar Sunrise, and the influence of the snowpack, *Atmos. Environ.*, 36, 2553–2562, 2002.
- 25 Trudinger, C. M., Etheridge, D. M., Rayner, P. J., Enting, I. G., Sturrock, G. A., and Langenfelds, R. L.: Reconstructing atmospheric histories from measurements of air composition in firn, *J. Geophys. Res.-Atmos.*, 107, doi:10.1029/2002JD002545, 2002.
- Trudinger, C. M., Etheridge, D. M., Sturrock, G. A., Fraser, P. J., Krummel, P. B., and McCulloch, A.: Atmospheric histories of halocarbons from analysis of Antarctic firn air: Methyl bromide, methyl chloride, chloroform, and dichloromethane, *J. Geophys. Res.-Atmos.*, 109, D22310 doi:10.1029/2004JD004932, 2004.
- 30 van de Wal, R. S. W., van Roijen, J. J., Raynaud, D., et al.: From $^{14}\text{C}/^{12}\text{C}$ measurements towards radiocarbon dating of ice, *Tellus*, 46B, 94–102, 1994.

A reconstruction of the past trend of atmospheric CO

S. S. Assonov et al.

Table 1. Location and characteristics of the three firn sites.

Site	Location	Altitude	Precipitation rate, cm H ₂ O*y ⁻¹	Annual mean temperature	Sampling dates
DML	77°02.39' S 10°30.08' W	2176 m	7	-39°C	January 1998
Dome C	75°06.1' S 123°23.7' E	3233 m	3	-54°C	Late December 1998 to early January 1999
Berkner	79°32.90' S 45°40.54' W	900 m	12	-26°C	January 2003

Title Page

Abstract

Introduction

Conclusions

References

Tables

Figures

◀

▶

◀

▶

Back

Close

Full Screen / Esc

Print Version

Interactive Discussion

EGU

Table 2. CO mixing and isotope ratios measured in firn air samples from Berkner Island. (All the values are blank corrected.)

Firn depth, m	Date, [dd/mm/yy]	CO ppbv, blank corrected*	$\delta^{13}\text{C}(\text{CO})^*$, ‰ VPDB	$\delta^{18}\text{O}(\text{CO})^*$ ‰
0.00	10/01/03	46.4±1.3	-28.2±0.5	-6.7
0.00	29/01/03	39.5±1.3	n.a.	n.a.
6.05	12/01/03	55.0±1.3	-28.1±0.5	-8.0
9.85	13/01/03	55.8±1.3	-27.9±0.5	-5.3
19.94	14/01/03	53.2±1.3	-28.7±0.5	-4.3
39.68	15/01/03	48.5±1.3	-28.2±0.5	-4.7
45.01	16/01/03	48.8±1.3	-28.1±0.5	-4.6
47.93	16/01/03	51.6±1.3	n.a.	n.a.
49.99	17/01/03	49.5±1.3	-28.2±0.5	-5.4
52.13	17/01/03	51.6±1.3	n.a.	n.a.
52.99	18/01/03	50.4±1.3	n.a.	n.a.
53.95	18/01/03	50.5±1.3	n.a.	n.a.
54.93	18/01/03	47.3±1.3	-27.5±0.5	-4.7
55.95	18/01/03	49.2±1.3	n.a.	n.a.
56.96	20/01/03	48.6±1.3	-27.0±0.5	n.a.
57.89	20/01/03	45.9±1.3	n.a.	n.a.
58.88	21/01/03	45.7±1.6**	n.a.	n.a.
58.88,	21/01/03	45.1±1.5**	-27.0±0.7	-4.5
large cylinder				
58.88,	21/01/03	45.5±1.6**	n.a.	n.a.
large cylinder, duplicate analysis				

* values are blank-corrected, assuming blank having $[\text{CO}] = 1.33 \pm 0.66$ ppbv and $\delta^{13}\text{C}(\text{CO}) = -50 \pm 15$ ‰. $\delta^{13}\text{C}(\text{CO})$ values have been corrected for gravitation as well as a difference in ^{13}C and ^{12}C diffusion rates and CO increase.

** values are corrected for contamination with ambient air being 15 ± 7.5 %. For this purpose, the lower value of 39.5 ppbv measured in the ambient air was used.

A reconstruction of the past trend of atmospheric CO

S. S. Assonov et al.

Title Page

Abstract

Introduction

Conclusions

References

Tables

Figures

◀

▶

◀

▶

Back

Close

Full Screen / Esc

Print Version

Interactive Discussion

**A reconstruction of
the past trend of
atmospheric CO**

S. S. Assonov et al.

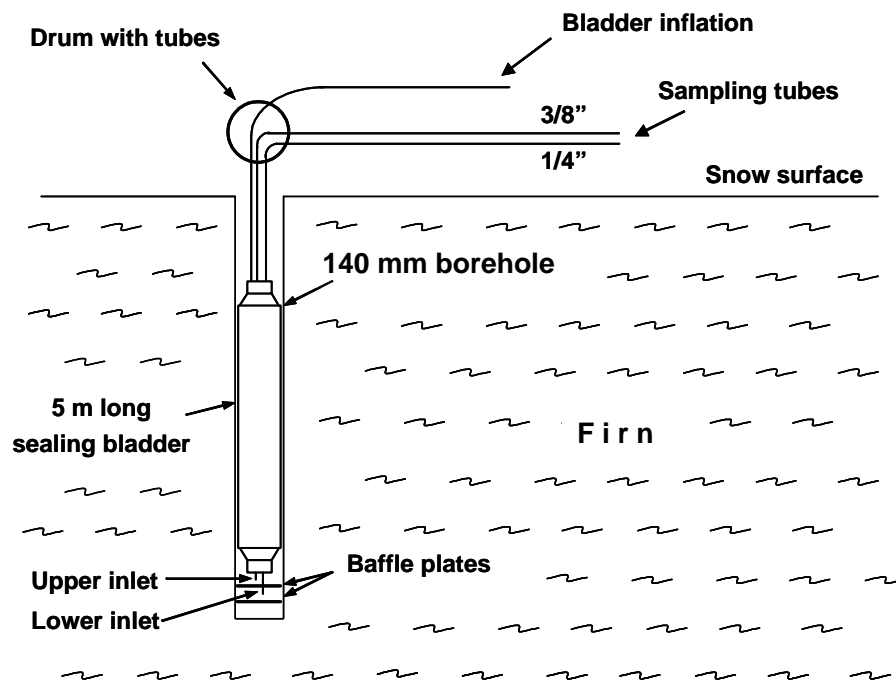

Fig. 1. A schematic of the firn air sampling system. The sections of the “Bender baffle” are 4.5 and 2.5 cm tall. Large air samples were collected from both the upper and lower sections.

[Title Page](#)[Abstract](#)[Introduction](#)[Conclusions](#)[References](#)[Tables](#)[Figures](#)[◀](#)[▶](#)[◀](#)[▶](#)[Back](#)[Close](#)[Full Screen / Esc](#)[Print Version](#)[Interactive Discussion](#)

EGU

**A reconstruction of
the past trend of
atmospheric CO**

S. S. Assonov et al.

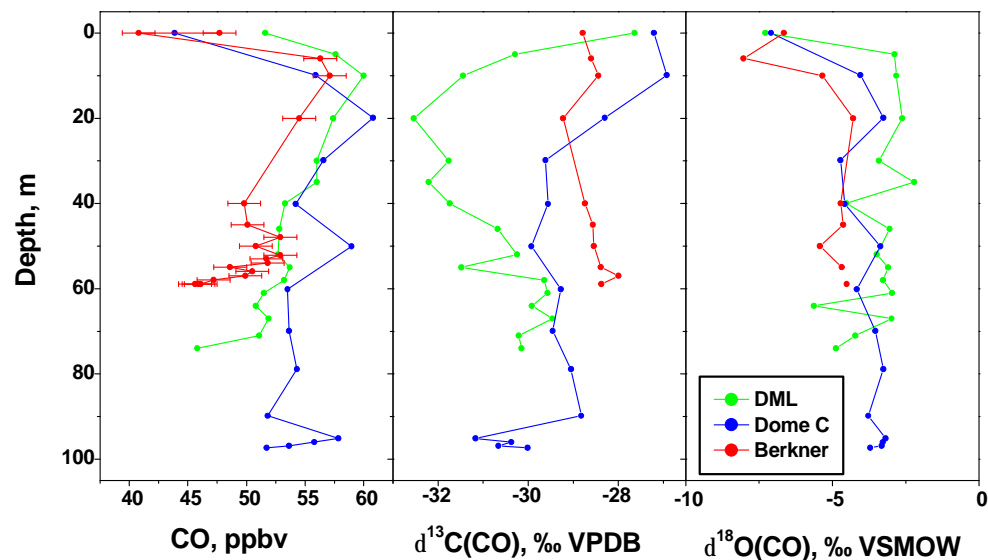

Fig. 2. CO mixing and isotope ratios measured at three sites in Antarctica. Data plotted here are not blank corrected. Blanks measured at Berkner demonstrated low CO values, at two other sites blanks were not measured.

[Title Page](#)[Abstract](#)[Introduction](#)[Conclusions](#)[References](#)[Tables](#)[Figures](#)[◀](#)[▶](#)[◀](#)[▶](#)[Back](#)[Close](#)[Full Screen / Esc](#)[Print Version](#)[Interactive Discussion](#)

EGU

**A reconstruction of
the past trend of
atmospheric CO**

S. S. Assonov et al.

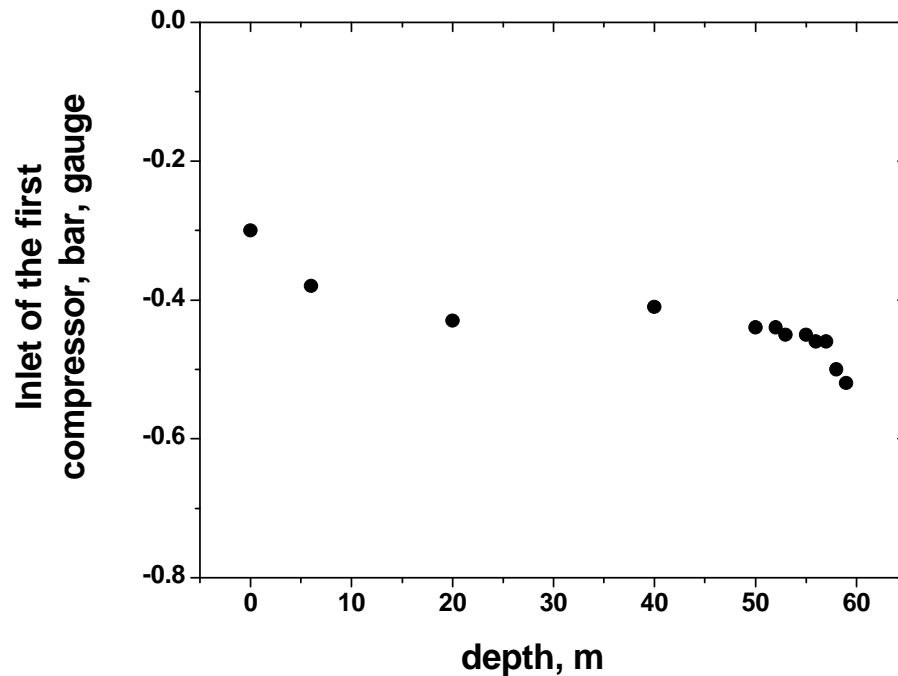
**Fig. 3.** Inlet pressure of the first compressor (metal bellows pump) during sampling.[Title Page](#)[Abstract](#)[Introduction](#)[Conclusions](#)[References](#)[Tables](#)[Figures](#)[◀](#)[▶](#)[◀](#)[▶](#)[Back](#)[Close](#)[Full Screen / Esc](#)[Print Version](#)[Interactive Discussion](#)

EGU

**A reconstruction of
the past trend of
atmospheric CO**

S. S. Assonov et al.

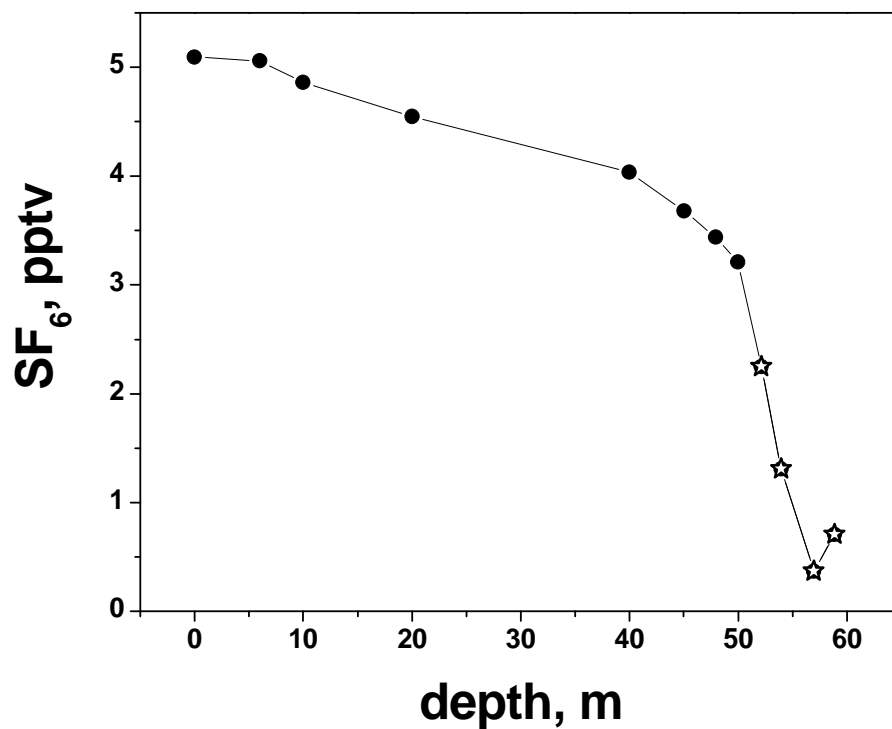

Fig. 4. Firm air samples from Berkner show an increase of SF₆ near COD. This indicates contamination with the ambient air, most likely due to a compressor leakage. Data obtained at MPI-Chemistry, Mainz are shown as circles, data obtained at University of Heidelberg – as stars. Error bars are smaller than the symbol size.

[Title Page](#)[Abstract](#)[Introduction](#)[Conclusions](#)[References](#)[Tables](#)[Figures](#)[◀](#)[▶](#)[◀](#)[▶](#)[Back](#)[Close](#)[Full Screen / Esc](#)[Print Version](#)[Interactive Discussion](#)

EGU

**A reconstruction of
the past trend of
atmospheric CO**

S. S. Assonov et al.

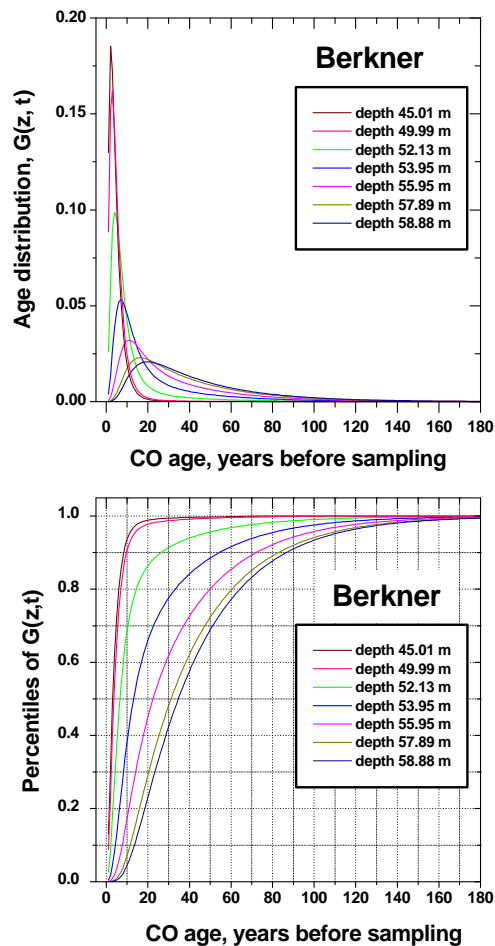

Fig. 5. CO age distributions modelled for several depth at Berkner (upper panel), and distribution percentiles (lower panel). For illustrative purpose, sets of discrete values $G(z, t)$ obtained for each depth are presented by a line.

[Title Page](#)[Abstract](#)[Introduction](#)[Conclusions](#)[References](#)[Tables](#)[Figures](#)[◀](#)[▶](#)[◀](#)[▶](#)[Back](#)[Close](#)[Full Screen / Esc](#)[Print Version](#)[Interactive Discussion](#)

**A reconstruction of
the past trend of
atmospheric CO**

S. S. Assonov et al.

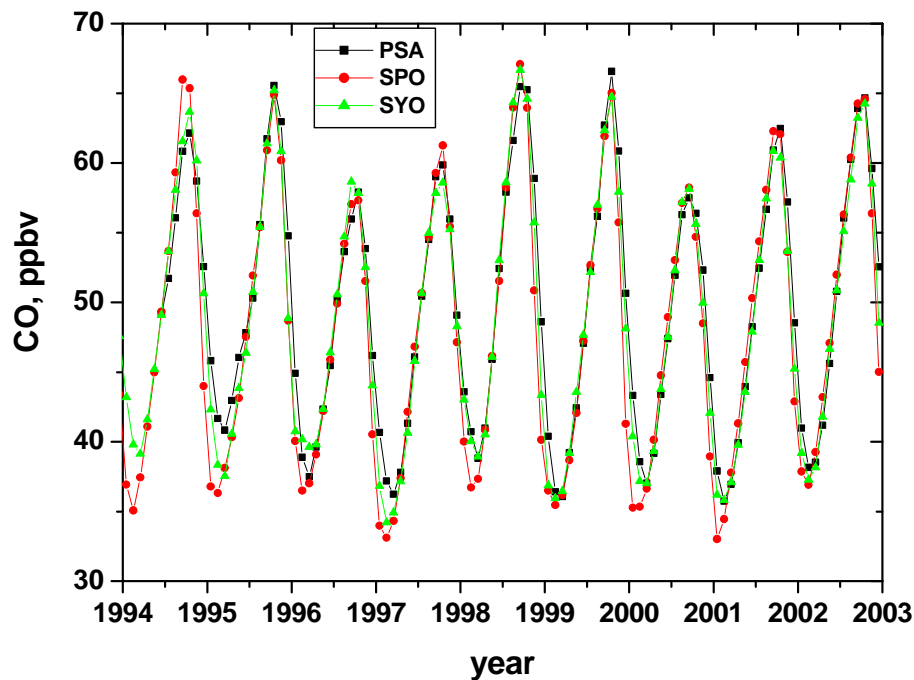

Fig. 6. CO observations by NOAA/CMDL at 3 Antarctic stations (Palmer, South Pole and Syowa stations, PSA, SPO and SYO), data from the NOAA/CMDL archive at <http://www.cmdl.noaa.gov/info/ftpdata.html> (downloaded on 5 July 2004). The year number stands for 1 January.

Title Page

Abstract

Introduction

Conclusions

References

Tables

Figures

◀

▶

◀

▶

Back

Close

Full Screen / Esc

Print Version

Interactive Discussion

EGU

**A reconstruction of
the past trend of
atmospheric CO**S. S. Assonov et al.

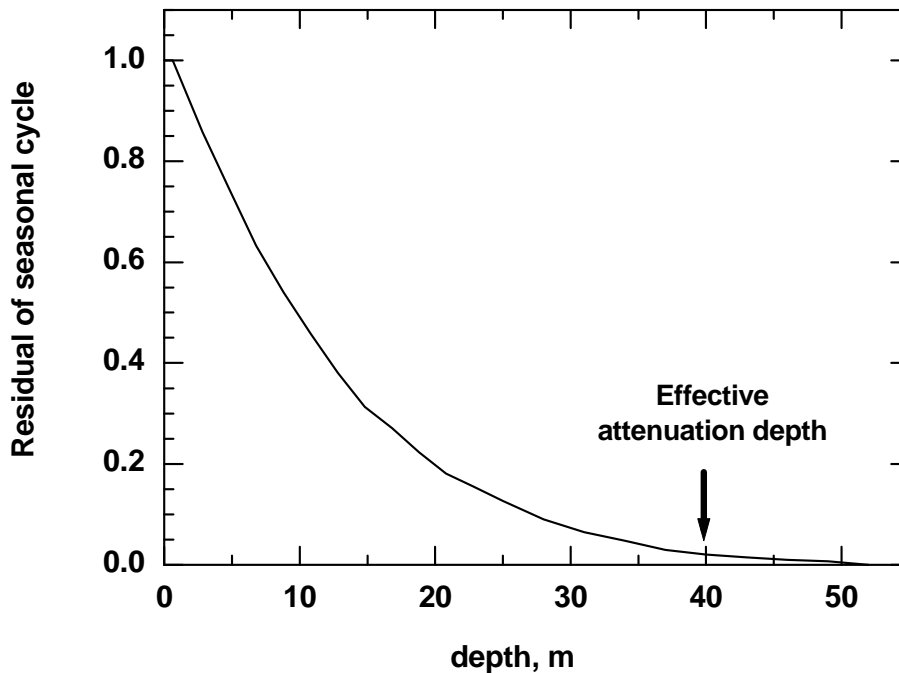

Fig. 7. To investigate the attenuation of the CO seasonal cycle at Berkner, model runs were performed using a number of scenarios, each next scenario having a seasonal cycle shifted by 1 month wrt to the preceding scenario. At depths of over 40 m the residuals of the attenuated cycle are smaller than $1/2\sigma$. This value is arbitrary as there are no samples between 19.94 and 39.68 m.

[Title Page](#)[Abstract](#)[Introduction](#)[Conclusions](#)[References](#)[Tables](#)[Figures](#)[◀](#)[▶](#)[◀](#)[▶](#)[Back](#)[Close](#)[Full Screen / Esc](#)[Print Version](#)[Interactive Discussion](#)

EGU

**A reconstruction of
the past trend of
atmospheric CO**S. S. Assonov et al.

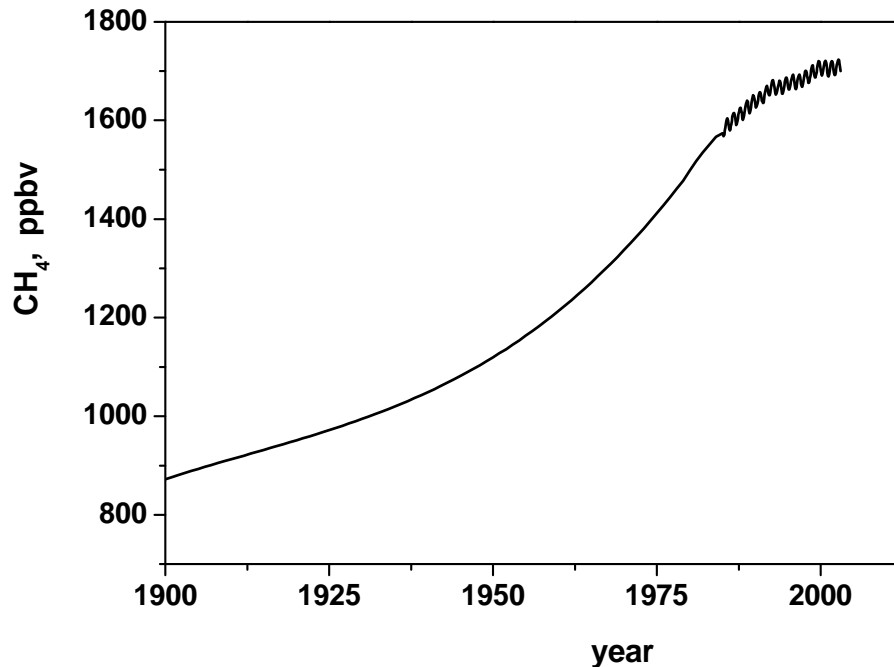

Fig. 8. A reconstruction of the atmospheric CH₄ trend using the Law Dome firn/ice core data (Etheridge et al., 1998) combined with NOAA/CMDL observations at three Antarctic stations starting in 1983 (South Pole, Halley, Palmer and Syowa, monthly means downloaded from <http://www.cmdl.noaa.gov/info/ftpdata.html> on 5 July 2004.)

[Title Page](#)[Abstract](#)[Introduction](#)[Conclusions](#)[References](#)[Tables](#)[Figures](#)[◀](#)[▶](#)[◀](#)[▶](#)[Back](#)[Close](#)[Full Screen / Esc](#)[Print Version](#)[Interactive Discussion](#)

EGU

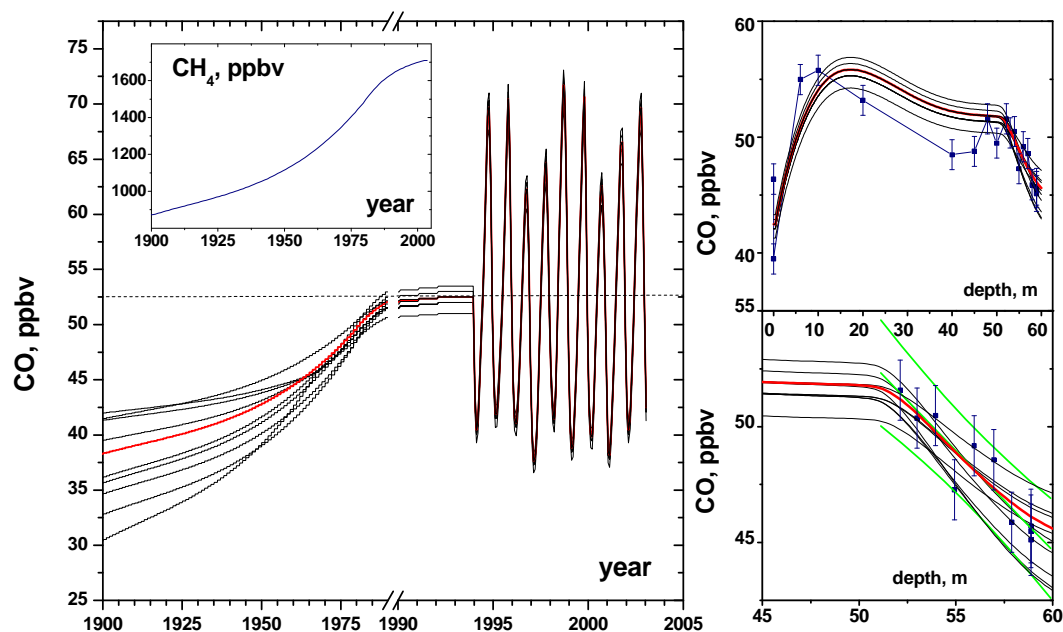

Fig. 9. A family of CO reconstructions based on modelled CO age distributions and the CH₄ year-to-year increase. The most plausible reconstruction is shown in red, other lines illustrate an uncertainty envelope. Two right panels show how well reconstructions reproduce observations. To visualise CO observations for the depth range from 52.13 to 58.88 m, the linear fit as well as its 95% certainty prediction are plotted (green lines, the right lower panel). Because the contribution from years preceding 1968 is small, reconstructions for 1968 and beyond have a larger uncertainty.

A reconstruction of the past trend of atmospheric CO

S. S. Assonov et al.

Title Page

Abstract

Introduction

Conclusions

References

Tables

Figures

◀

▶

◀

▶

Back

Close

Full Screen / Esc

Print Version

Interactive Discussion

EGU

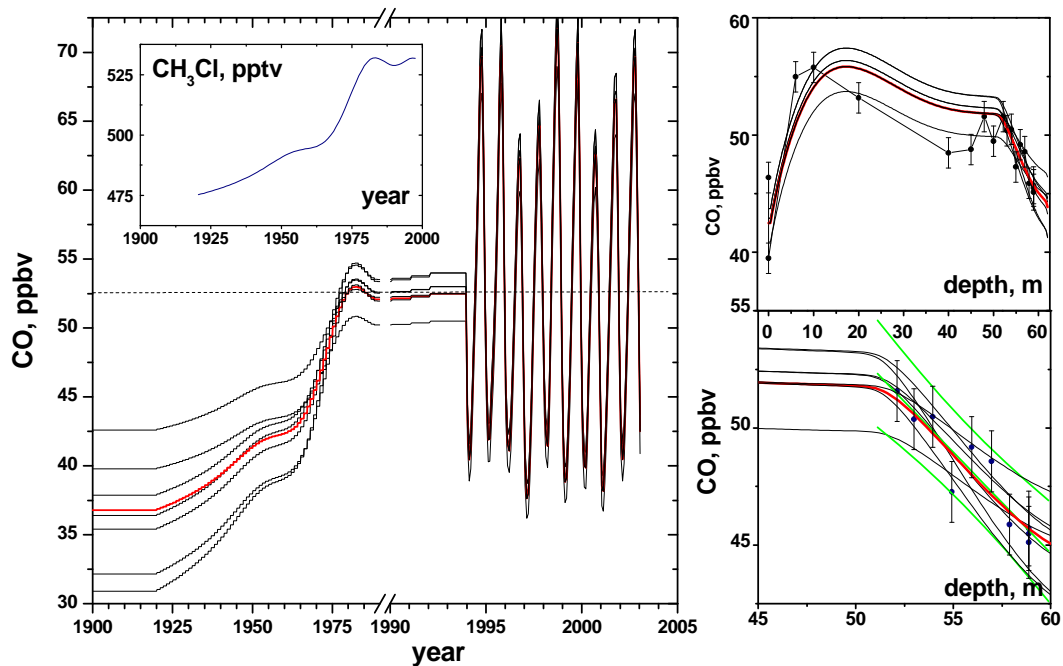

Fig. 10. A family of CO reconstructions based on modelled CO age distributions and the CH_3Cl year-to-year increase (data from Trudinger et al., 2004). This figure is constructed in the same way as Fig. 9.

A reconstruction of the past trend of atmospheric CO

S. S. Assonov et al.

Title Page

Abstract

Introduction

Conclusions

References

Tables

Figures

◀

▶

◀

▶

Back

Close

Full Screen / Esc

Print Version

Interactive Discussion

EGU

**A reconstruction of
the past trend of
atmospheric CO**

S. S. Assonov et al.

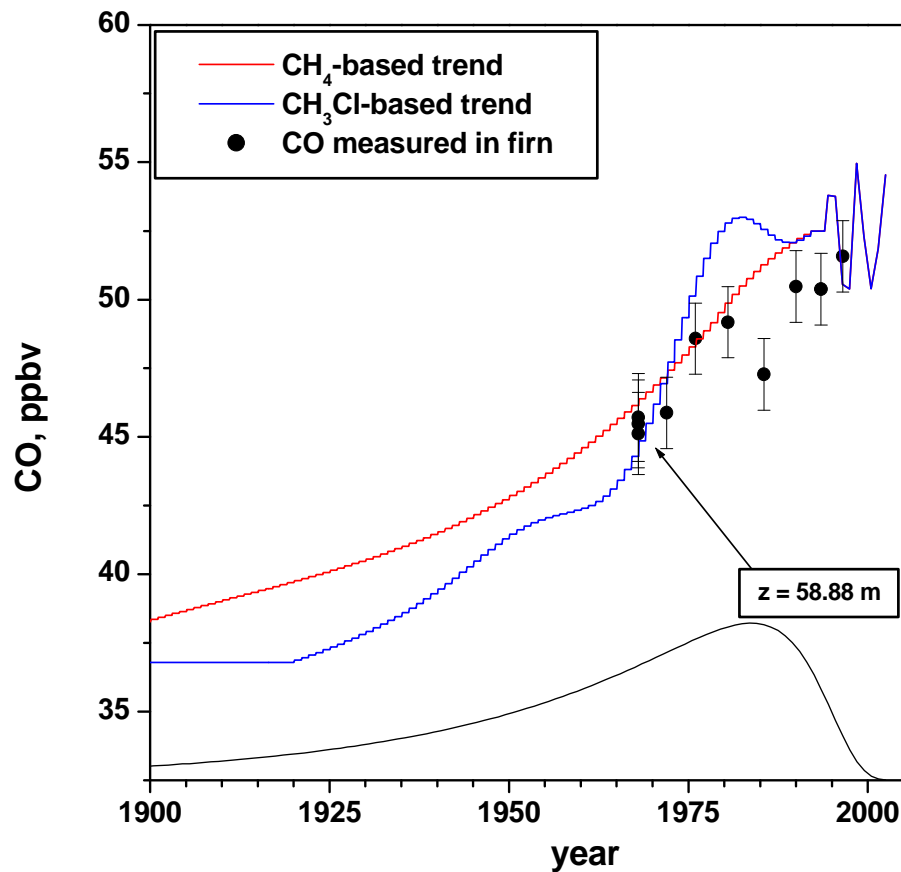

Fig. 11. CO reconstructions based on CH₄ and CH₃Cl trends and measured CO values plotted vs. respective means of model age distributions. Only annual means are presented, without seasonal cycle. Because the age distributions are rather broad (shown for the sample 58.88 m, not to scale), the measured points fall not necessarily on the reconstructed trends.

[Title Page](#)[Abstract](#)[Introduction](#)[Conclusions](#)[References](#)[Tables](#)[Figures](#)[◀](#)[▶](#)[◀](#)[▶](#)[Back](#)[Close](#)[Full Screen / Esc](#)[Print Version](#)[Interactive Discussion](#)

EGU

**A reconstruction of
the past trend of
atmospheric CO**

S. S. Assonov et al.

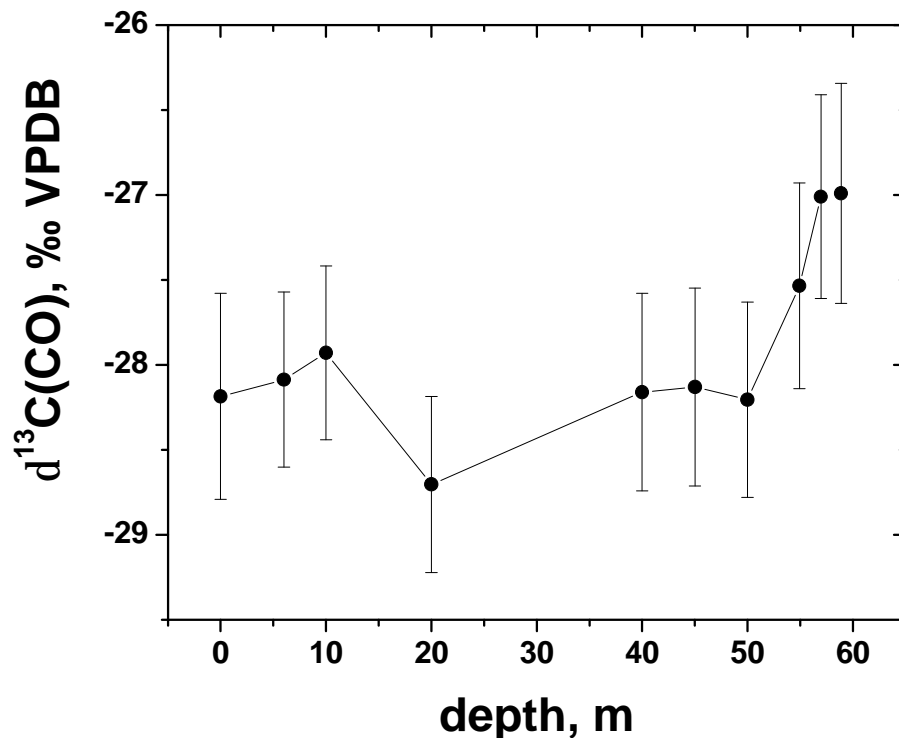

Fig. 12. $\delta^{13}\text{C}(\text{CO})$ trend with depth. Corrections were applied as following: (1) correction for the blank using the measured CO blank of 1.3 ± 0.7 ppbv and assuming $\delta^{13}\text{C}(\text{CO}) = -50 \pm 15\text{‰}$. This correction being $\sim 0.6\text{‰}$ is positive; (2) correction for $\delta^{13}\text{C}(\text{CO})$ due to gravitation effect and an interplay of CO increase and a difference in diffusion rates of ^{13}C and ^{12}C . The later correction was modelled by using the most probable CO scenario (Figs. 9 and 10) and zero trend of $\delta^{13}\text{C}(\text{CO})$. This correction (being -0.2‰ at 49.99 m) increases with depths, reaching $+0.7\text{‰}$ for the depth 58.88 m.

[Title Page](#)[Abstract](#)[Introduction](#)[Conclusions](#)[References](#)[Tables](#)[Figures](#)[◀](#)[▶](#)[◀](#)[▶](#)[Back](#)[Close](#)[Full Screen / Esc](#)[Print Version](#)[Interactive Discussion](#)

EGU