



HAL
open science

IEEE 802.11 Load balancing: an approach for QoS Enhancement

Issam Jabri, Nicolas Krommenacker, Thierry Divoux, Adel Soudani

► **To cite this version:**

Issam Jabri, Nicolas Krommenacker, Thierry Divoux, Adel Soudani. IEEE 802.11 Load balancing: an approach for QoS Enhancement. International Journal of Wireless Information Networks, 2008, 15 (1), pp.16-30. 10.1007/s10776-008-0072-y . hal-00326059

HAL Id: hal-00326059

<https://hal.science/hal-00326059>

Submitted on 8 Oct 2008

HAL is a multi-disciplinary open access archive for the deposit and dissemination of scientific research documents, whether they are published or not. The documents may come from teaching and research institutions in France or abroad, or from public or private research centers.

L'archive ouverte pluridisciplinaire **HAL**, est destinée au dépôt et à la diffusion de documents scientifiques de niveau recherche, publiés ou non, émanant des établissements d'enseignement et de recherche français ou étrangers, des laboratoires publics ou privés.

IEEE 802.11 Load balancing: an approach for QoS Enhancement

Issam JABRI^{1,2}, Thierry DIVOUX¹, Nicolas KROMMENACKER¹, Adel SOUDANI²

(1) Centre de Recherche en Automatique de Nancy (CRAN - UMR 7039),

Nancy-University, CNRS, BP239, 54506 Vandoeuvre, France

(2) Laboratoire Electronique et Micro Electronique (E μ E), Faculté des Sciences de

Monastir,

5019 Monastir, Tunisie

Abstract. With the 802.11 WLAN multimedia applications (Video, Audio, real-time voice over IP,...) increasing, providing Quality of Service (QoS) support becomes very important since the original standard doesn't take QoS into account. The standard offers access to the wireless users only regarding physical considerations. This can lead to overloaded access points (AP) and considerable degradation of the QoS. This paper deals with this problem. It focuses on the presentation of a QoS management solution for wireless communication systems. It mainly defends that a balanced distribution of mobile stations among the available Access Points leads to better performances of the Wireless LAN. Some OPNET simulations of the proposed approach are presented to show a better resources allocation and efficiency on QoS metrics. A protocol structure between mobiles and APs is also specified for the implementation of this approach. An SDL description and MSC simulation of this protocol is provided as a first step in its development.

Keywords. IEEE802.11, Load Balancing, Quality of Service, Protocol Specification, OPNET.

1 Introduction

In the last few years the IEEE 802.11 technology becomes very interesting. One of its popular uses is its cheap hardware infrastructure price promoting to provide practical and efficient Hotspots environment [1]. The research works [1], [2] carried in this context had proved that additional effort is yet required to build up a system with a high service quality. A specification of further interaction in the IEEE 802.11 protocol between APs and mobiles mainly during the call admission stage will help to ensure some QoS parameters such as load distribution and packet losses. The standard IEEE 802.11e [14] has been defined to ensure quality of service in Wireless LAN.

This paper presents the benefits of the load balancing approach to enhance the QoS support in the context of Hotspots communication environment. The first part presents an overview of the present quality of service mechanisms for the IEEE 802.11 wireless LAN. The second part presents the load balancing approach. We then focus on the description of the general hotspots environment architecture and the load balancing algorithm. The next part presents the definition of new protocol primitives between the mobile stations and the access points managing QoS metrics. Then we present the description of this protocol with the SDL language (Specification and Description Language) [5] and some MSC (Message Sequence Charts) simulation results of the behaviour of this protocol. The next part demonstrates some OPNET simulation results showing the enhancement of QoS parameters when applying the load balancing approach. We finish by highlighting future contributions in this field.

2 Overview of QoS Mechanisms for IEEE 802.11 Wireless LAN

2.1 QoS Limitations of IEEE 802.11 Wireless LAN

Channel access control, Quality of Service, and data security are the most important functions of a wireless MAC layer. Wireless links have specific characteristics such as large packet delay and jitter, high loss rate, bursts of frame loss and packet reordering. Furthermore, the wireless link characteristics are not constant and vary over time and place [7]. Mobility of users may cause the end-to-end path to change when users are roaming. Users expect to receive the same QoS once changing their point of attachment. This implies that the new path should also support the existing QoS, and problems may arise when the new path cannot support such requirements [7]. IEEE 802.11 networks are based on the Distributed Coordination Function (DCF) which is a best effort method and do not support QoS for time critical applications. All stations in a Basic Service Set (BSS) have the same priority to access the channel. There are no differentiation mechanisms to guarantee bandwidth, packet delay or jitter for high priority stations with times-bounded applications or multimedia flows. In [7], authors have made simulations on an ad hoc topology in which stations transmit three types of traffic (audio, video and background traffic) to each other. These simulations clearly show that there is no throughput or delay differentiation between different flows since only one queue is shared by all the three flows. So, there is no way to guarantee the QoS requirements for high-priority audio and video traffics unless admission control is used.

A Point Coordination Function (PCF) mode has been designed to support time-bounded multimedia applications, but it has many problems that lead to poor QoS performances [12], [13]. In this mode, wireless resources are wasted since all communications between stations in the same BSS have to go through the Access Point. This mode must be implemented with the

DCF mode. Cooperation between Contention Period and Contention Free Period may lead to unpredictable beacon delays [13]: to switch from DCF to PCF, the wireless channel must be idle. The access point is not authorised to stop an established communication to make on the PCF mode and then we have no guarantee on the DCF mode duration. With PCF mode, it is difficult to an access point to define time needed by each polled station to transmit data frames. The transmission time of polled stations is difficult to control since the physical rate can be changed according to the varying channel status.

All these limitations for both DCF and PCF led to a large number of research activities to enhance the performance of 802.11 MAC.

2.2 QoS Mechanisms for IEEE 802.11 Wireless LAN

Most existing QoS mechanism for 802.11 can be classified into three categories [15]:

Service Differentiation. Basically, service differentiation is achieved by two main methods: priority and fair scheduling [16]. While the former binds channel access to different traffic classes by prioritized contention parameters, the latter partitions the channel bandwidth fairly by regulating wait times of traffic classes in proportion according to given weights [15]. Used parameters for both approaches are Contention Window (CW) size, Backoff algorithm and Inter Frame Space (IFS). The main service differentiation mechanism is the 802.11e standard [22]. An access method called Hybrid Coordination Function (HCF) is introduced. It is a queue-based service differentiation that uses both DCF and PCF enhancements. HCF describes some enhanced QoS-specific functions, called contention-based HCF channel access and polling-based HCF access channel. These two functions are used during both contention and contention free periods to ensure QoS. Enhanced DCF (EDCF) is the contention-based HCF channel access. The goal of this scheme is to enhance DCF access mechanism of IEEE 802.11 and to provide a distributed access approach that can support

service differentiation. The proposed scheme provides capability for up to eight types of traffic classes. It assigns a short contention window to high priority classes in order to ensure that in most cases, high priority classes will be able to transmit before the low-priority ones. For further differentiation, 802.11e proposes the use of different IFS set according to traffic classes. Instead of a DCF IFS (DIFS), an Arbitration IFS (AIFS) is used. Classes with smallest AIFS will have the highest priority.

Admission Control and Bandwidth Reservation. Service differentiation is helpful in providing better QoS for multimedia data traffic under low to medium traffic load conditions. However, due to the inefficiency of the IEEE 802.11 MAC, service differentiation does not perform well under high traffic load conditions [12]. In this case admission control and bandwidth reservation become necessary in order to guarantee QoS of existing traffic. These two approaches are quite difficult to realise due to the nature of the wireless link and the access method. Admission control schemes can be broadly classified into measurement-based and calculation-based methods. In measurement-based schemes, admission control decisions are made based on the measurement of existing network status, such as throughput and delay. On the other hand, calculation-based schemes construct certain performance metrics or criteria for evaluating the status of the network [15].

Link Adaptation. 802.11 specifies multiple transmission rates but it intentionally leaves the rate adaptation and signalling mechanisms open. Since transmission rates differ with the channel conditions, an appropriate link adaptation mechanism is desirable to maximize the throughput under dynamically changing channel conditions [15]. Most link adaptation mechanisms focus on algorithms to switch among transmission rates specified in the Physical Layer Convergence Procedure.

These different mechanisms aiming to enhance the quality of service support in the IEEE 802.11 wireless LAN consider the network locally. For example parameters differentiations are made at the node level. Compared to [15], we identify several research initiatives focusing on load balancing wireless LAN to enhance its global performance.

Load Balancing. The work in [17] proposed a dynamic load balance algorithm to maximize the average Received Signal Strength and minimize the amount of associated stations per access point. An other work [11] proposed some packet level load balancing mechanisms based on the number of calls admitted in a cell. In [10], authors proposed a distributed load balancing architecture based on the access point's load. Over loaded access points are not authorized to associate new coming stations. The state of an access point (over loaded or not) is compared only to the neighbors AP. The defined algorithm can lead to a non optimized number of dissociations and associations. The authors of [2] describe a centralized load balancing algorithm which is not completely transparent to wireless users: stations have to explicitly change positions to get the required quality of service. A scheme proposed in [18] aims to fairly distribute load between access points by changing their coverage area. Some other works describe load balancing mechanisms for 802.11 wireless networks but are applied in particular contexts such as in [19] which study a routing connection admission control in ESS (Extended Service Set) mesh networks.

2.3 Our Proposal Regarding The Previous QoS Mechanisms

The keystone of our approach is to consider the wireless LAN as a whole, and not only locally, in order to fulfil an increasing number of accepted applications with guaranteed quality of service level. Contrarily to other methods, we choose to remain compatible with the IEEE 802.11 standard. we propose a new load balancing approach between wireless network access points. Our approach, mainly takes into account the quality of service requirements of

each mobile station. Compared to other works, our solution is completely transparent for the mobile stations. It's a global solution which enables a fair load distribution among all the access points of a public area network. In this general approach, which can be applied in all wireless public area networks, we propose a new load balancing algorithm but also new primitives enabling to implement the solution into a 802.11 wireless network. These primitives are not a substitution to the 802.11 standard but rather an extension.

3 General Presentation of Our Approach

The QoS management on hotspots environment becomes vital for many emerging applications such as mobile information access, real time multimedia communications, networked games, immersion worlds and cooperative work. These require a minimum level of QoS [7], [8], [13], [20] and [21]. The hotspots environment can be described as a set of access points covering overlapping cells and offering connection to a variable number of mobile stations. User's applications are not similar in terms of QoS requirements so that a fair distribution of the mobile stations among active access points can guarantee a minimum level of quality of service. The bandwidth effectively offered (C_{\max}) by an access point is given by the Shannon formula ($C_{\max} = BW \times \log_2(1 + \text{SNR})$ where BW is the bandwidth and SNR the signal-to-noise ratio). So, due to the wireless environments (interferences, obstacles...) bandwidth is scarce and channel conditions will be time-varying and sometimes highly lossy. Unfortunately, in the actual IEEE 802.11 protocol, a mobile station is associated to the access point offering the best SNR independently of the load being applied to the access point by other users. This can cause, in many cases, unbalanced load between access points. Some access points will be over loaded, others are under loaded. For the first ones applications requirements are not fulfilled. The keystone of our approach is to associate mobile station to access points with a minimum SNR threshold and offering the best QoS level.

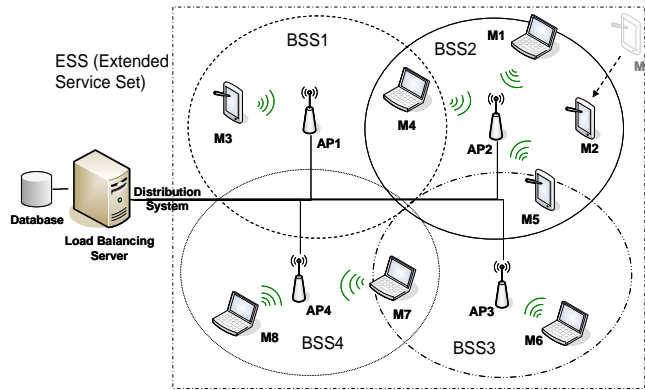

Fig. 1. IEEE 802.11 target architecture

The Figure 1 illustrates the idea that we develop in this paper. A new mobile station (M2) reaching the WLAN must be associated with an AP. The association procedure is always initiated by the station (mobile-controlled handover) and the station can be associated with only one AP. The new station must discover which APs are present and then requests to establish an association with one of them. Thus, first the station initiates a scanning process that can be either active or passive [3]. Once the scanning process has finished, the station updates its list of access points in range (AP2).

This information is used by the station to associate with the access point that provides the highest SNR. M2 have to associate with AP2. Supposing that all mobile stations generate the same data traffic, the load distribution across access points will be highly uneven [1]. This can cause a performance degradation perceived by the other stations attached to AP2. Quality of service contracts (bandwidth, loss rate...) may be violated. It will be attractive to redistribute mobile stations among APs even with lower SNR. A fair distribution of mobile stations among APs fulfills the QoS requirements of both old and recent associated stations: the available bandwidth of the WLAN link depends strongly on the number of active stations and their traffic. For example, in the topology presented in figure 1, it will be interesting to

reassociate M4 to AP1 or/and M5 to AP3 to be able to associate M2 with the quality of service requested while keeping the level of service offered to the other stations.

To achieve this balancing, in terms of quality of service offered to the stations (load, loss rate...) among APs, we have to compute a balancing algorithm each time a new event such as the arrival of new stations or the mobility of existing stations. This algorithm has to find the best state of associations between APs and mobile stations that offers the best quality of service level for user’s applications. Thus, we have to get information on associated stations, traffic coursed by APs and users quality of service requirements (Figure 2). This information has to be exchanged between WLAN entities and stored in an updated data base.

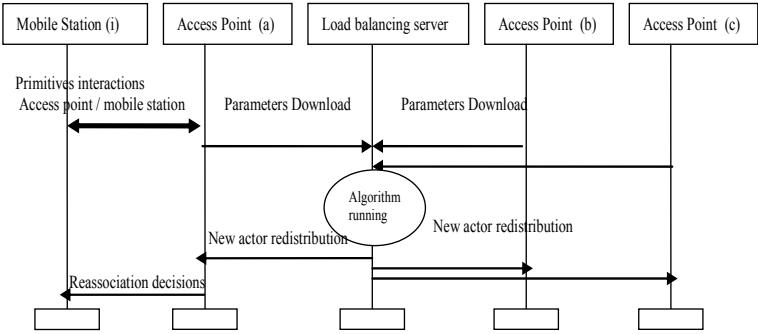

Fig. 2. System protocol interactions

In this architecture the load balancing server should periodically download a set of specific parameters from each access point. It executes the balancing algorithm in order to find the best mobile station distribution among access points. The result will be broadcasted in the system. Then, we have defined for this architecture a set of new metrics to quantify the quality of service and primitives to exchange these parameters for association and disassociation between mobile station and access point. These primitives that should be inserted into the MAC layer to improve the IEEE 802.11 standard [14] define a new MAC quality of service policy for wireless LANs.

4 The New Load Balancing Algorithm

4.1. Load Balancing Algorithm Description

The use of a load balancing algorithm has been also proposed by [10] and [11]. Our original proposed algorithm [9] is computed by the load balancing server every time a new distribution is needed in the wireless LAN. This will take place (i) when a new mobile station enters the wireless LAN and aims to associate with an access point, (ii) when an associated station is moving from one to another BSS and (iii) when the applications requirements in a mobile station are changing. The downloaded parameters from the access points and mobile station applications will be useful to find the best distribution of mobile stations among wireless LAN access points. This algorithm checks if the new distribution is balanced mainly by computing a balance index β . The balance index appeared in the first time in [6] and it is used in [2], [10] as a performance measure. The balance index reflects the used capacity in each access point. We compute the balance index in each overlapping zone between two or more APs in the WLAN Extended Service Set.

Let T_i be the total traffic of the AP_i . Then, the balance index β_j of an overlapping zone Z_j is:

$$\beta_j = (\sum_i T_i)^2 / (n * \sum_i T_i^2)$$

With T_i is the total traffic of an AP_i overlapping with other access points in the zone j and n is the number of access points overlapping in the zone j .

The proposed distribution of mobile stations is balanced if the balance indexes of all the overlapping cells converge to 1. At this step, overlapping Access Points in the Wireless LAN are fairly loaded. We use a tolerance parameter α that defines the balancing zone width. An AP is considered overloaded if its load exceeds a certain threshold $\delta_1 = ANL + \alpha.ANL$, where

ANL is the Average Network Load. It is balanced when its load is in the interval $[\delta_1, \delta_2]$, $\delta_2 = \text{ANL} - \alpha \cdot \text{ANL}$. An AP is under loaded if its load is under δ_2 . To have more balanced APs, a smaller value of the parameter α must be chosen. This can increase the load balancing algorithm execution time.

The load balancing algorithm is computed according to the general diagram presented in Figure 3. When a new event occurs in the wireless LAN the load balancing algorithm calculates the average network load and the δ_1 and δ_2 balancing thresholds. If there is some overloaded access point, the algorithm has to seek for a new distribution of mobile stations to have balanced load among access points. Mobile stations have to be moved from overloaded access points to less loaded ones overlapping in the zone_{\min} . Zone_{\min} is the overlapping zone which has the minimum balance index value. The load balancing algorithm computes the difference between the load of the most loaded AP and the average network load. The station to move is the one with the load nearest to this difference (we suppose negligible the effect of handover on the station applications running).

Then, the algorithm has to send the new load distribution to the access points which will dissociate, associate and reassociate mobile stations.

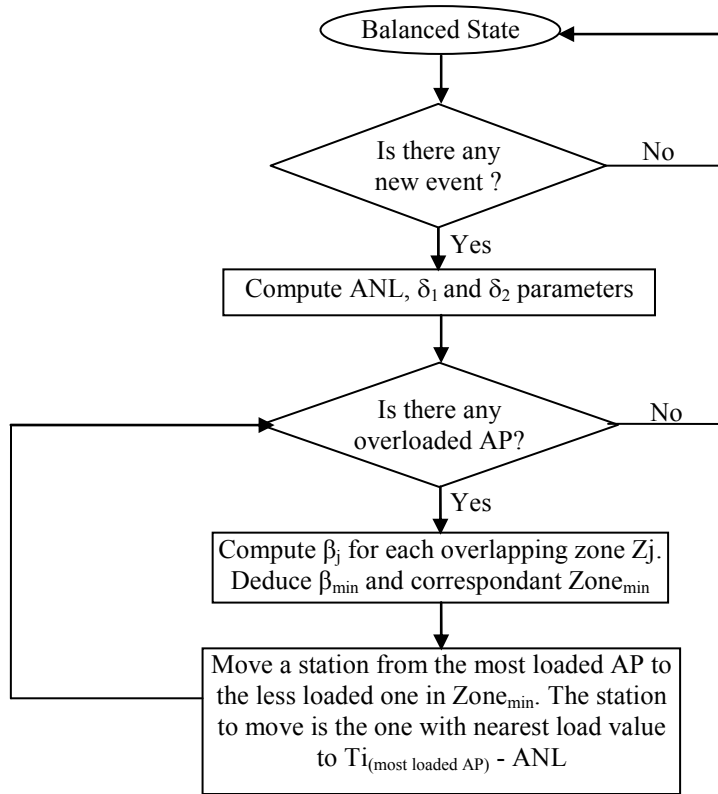

Figure 3 General diagram of the Load Balancing Algorithm

4.2. Example

In this section, we present (Figure 4) a Wireless LAN with 3 Access Points AP1, AP2 and AP3. The communication range of each access point is about 311 meters. We define three application types, Data, Video and Voice. Packet generation for each application profile are illustrated in table 1. For each mobile station, a single type of traffic is specified. We set names to each station according to the traffic coursed in it. All applications sent their data to a Destination_server which is connected to the access points across a 100 Mbps Ethernet LAN.

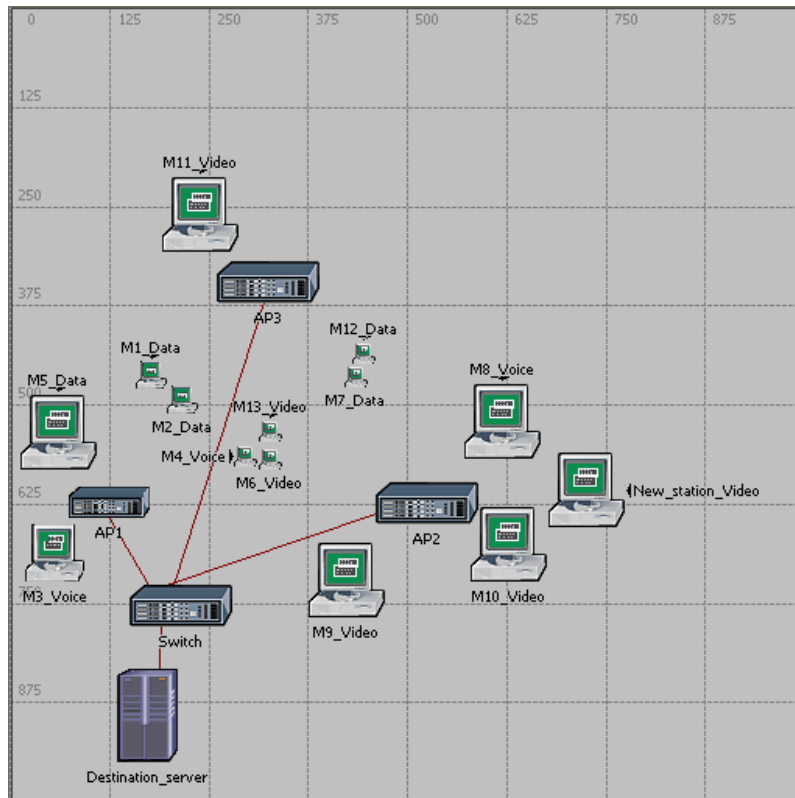

Figure 4 Wireless LAN Topology (OPNET screen)

Table 1 Application Profiles

Application profile	Packet Arrival time (sec)	Inter (sec)	Packets Length (Byte)	Fragmentation threshold (Byte)	Transmission rate (kbps)
Data	Exponential (0,05)		Constant (3750)	1500	600
Video		Constant (0,1)	Constant (12520)	1500	1000
Voice		Constant (0,02)	Constant (96)	1500	38,4

Distances between mobile stations and access points are given by table 2. The asterisk indicate the access point to which a mobile station is actually associated.

Table 2 Association Map

	Distance to AP1 (m)	Distance to AP2 (m)	Distance to AP3 (m)	Overlapping Zone
M1_Data	*169	382	189	Zone 1
M2_Data	*159	333	184	Zone 1
M3_Voice	*93	472	434	
M4_Voice	*181	236	222	Zone 3
M5_Data	*109	472	326	
M6_Video	209	*205	225	Zone 3
M7_Data	348	*182	163	Zone 2
M8_Voice	505	*139	344	
M9_Video	315	*141	390	
M10_Video	505	*115	449	
M11_Video	380	461	*120	
M12_Data	371	204	*150	Zone 2
M13_Video	221	217	*189	Zone 3
New_Station_Video	600	201	479	

In addition to stations in the range of only one access points (no overlapping zone), stations are distributed within three overlapping zone: Zone1 between AP1 and AP3, Zone2 between AP2 and AP3 and Zone3 between AP1, AP2 and AP3.

The arrival of the New_station_Video which is only in the range of AP2 activates the load balancing algorithm. This one calculates ANL, δ_1 and δ_2 parameters ($\alpha=20\%$). The total loads coursed by access points are $T_{AP1} = 1876,8$ kbps, $T_{AP2} = 4638,4$ kbps and $T_{AP3} = 2600$ kbps.

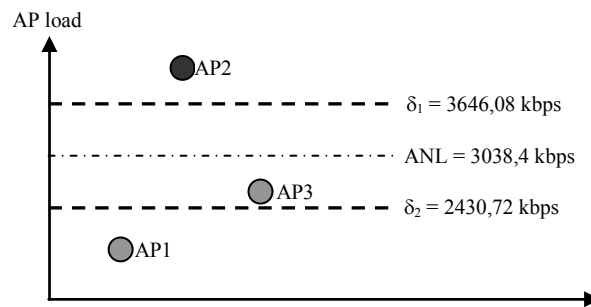

Figure 5 AP loads

AP2 is overloaded (Figure 5). The load balancing algorithm has to redistribute mobile stations associations. It calculates the load balance indexes in each overlapping zone ($\beta_1 = 0,9745$, $\beta_2 = 0,9265$ and $\beta_3 = 0,874$). So, we have to reassociate a mobile station in the zone3 from the most loaded AP (here AP2) to the less loaded one (here AP1). Among the stations located in Zone3 (M4_Voice, M6_Video and M13_Video), we have to choose the one with the nearest load value to $T_{AP2}-ANL=1600$ kbps. That's mean we have to reassociate M6_Video from AP2 to AP1.

When recalculating the total load coursed by each access point ($T_{AP1} = 2876,8$ kbps, $T_{AP2} = 3638,4$ kbps and $T_{AP3} = 2600$ kbps) we can see that there is no overloaded AP. We can also see that we have better values for the different balance indexes ($\beta_1 = 0,9974$, $\beta_2 = 0,9730$ and $\beta_3 = 0,9795$).

The load balancing algorithm has now to broadcast the new distribution (balanced state) to the APs. For that, new primitives have to be define to extend the 802.11 MAC protocol.

5 Protocol Specification

5.1 QoS Protocol Parameters

In this approach, the QoS management is based on the idea that some added primitives must be ensured at the MAC level between the mobile stations and the access points. Then, each mobile in the wireless LAN may be able to propose some QoS parameters and to modify them when needed. Here, we propose to use two QoS parameters which are Bandwidth (BW) and Packet Loss Rate (PLR). Other QoS parameters such as Transmission Delay (TD) can be also taken into account. Here, we are not interested in the methods put to collect the whole of these parameters.

5.2 Device Identification

To ensure QoS management in the WLAN some identifiers should be joined to the parameters describing the quality of service requirements in each mobile station. These identifiers are maintained in specific databases at the load balancing server, the access point and the mobile station. Each mobile station will then discuss the attachment attempt responses of the access point according to its own QoS parameters. Table 3 sums up the parameters used in our approach.

Table 3. New wireless entities parameters

Parameters	Function
ID_M	The mobile station identifier
ID_{AP}	The Access Point identifier

ID _{APOld}	Defines the old Access Point identifier when making redistribution
ID _{APNew}	Defines the New Access Point identifier when making redistribution
M/F	Describes the moving state of the a mobile station
Y/N	Describes if other Access Points are in the range of a mobile station
List	Gives the list of access points in range if Y/N parameter is set to Y

These parameters have to be saved in a specific data base managing the whole environment of the wireless devices. This database communicates with the other layers defined in the IEEE 802.11 model to ensure coordination during the call admission processes.

5.3 QoS Protocol Primitives

The IEEE 802.11 suffers from lack of specific QoS primitives. The only parameter on which is based the connection negotiation between the AP and the mobile station is the SNR ratio. The satisfaction of only this parameter at the connection phase doesn't meet necessary the QoS requirements of the application. So it appears crucial to specify new protocol primitives to enable the integration of other communication parameters for the connection decision (here the Bandwidth and the Packet Loss Rate) and then during the load redistribution. We have then defined a set of new primitives expressing general requirements.

Table 4. Quality of service primitives

Primitives	Access Point	Mobile Station	Load balancing server	Parameters	Description
Connect_req		*		ID _M , ID _{AP} , BP, PLR, M/F, Y/N, List	Station connection request
Connect_ack	*			ID _M , ID _{AP} , BP, PLR	AP answering positively for a station connection request
Server_update	*			ID _M , ID _{AP} , BP, PLR	AP updating server about its current state
New_distr_req	*			ID _M , ID _{AP} , BP, PLR, M/F, Y/N, List	AP asking the server for stations redistribution
Distr_neg_ack			*		Negative acknowledgement for a new distribution request
New_distr_notif			*	(ID _M , ID _{APOld} , ID _{APNew}) ⁿ	Notification of a new distribution to apply
Wait	*		*	ID _M , ID _{AP}	A request for waiting

6 Scenario Description

The primitives that we defined in the last section are used to manage the access of the mobile stations to the wireless LAN via access points. We have checked the extended protocol with many communications scenarios. Communications scenarios vary from simple to much complex situations. In this paragraph we describe one of the scenarios. We take as example the wireless topology described in Figure 4. Once New_Station_Video arriving to the AP2 cell, the load balancing algorithm is computed. The load balancing server broadcasts the new distribution of mobile stations onto the access points. As a result, AP2 have to dissociate the mobile station M6_Video. This mobile will be associated to AP1 which is able to give it the required quality of service level. Finally New_Station_Video and AP2 complete the association procedure to obtain the balanced wireless network topology.

The scenario that we have defined will be described and verified with the SDL and MSC languages in the following sections.

6.1 SDL Protocol Description

The SDL pattern is an efficient design language for the development of a communication system. It enables a formal description system by defining a static modular architecture and interactions between different blocks [4]. Systems in SDL language are structured into interconnected entities (system, block, process, and channel) where process system description provides dynamic behaviour for internal task execution. It is based on the model of Extended Finite State Machines (EFSMs) [5]. In its dynamic behaviour, each state is reached after asynchronous signal exchange between blocks.

New primitives and exchanges defined in our approach have been described and validated with SDL. Figure 6 shows the SDL model of a hotspot. It represents exchanges between access points and the load balancing server.

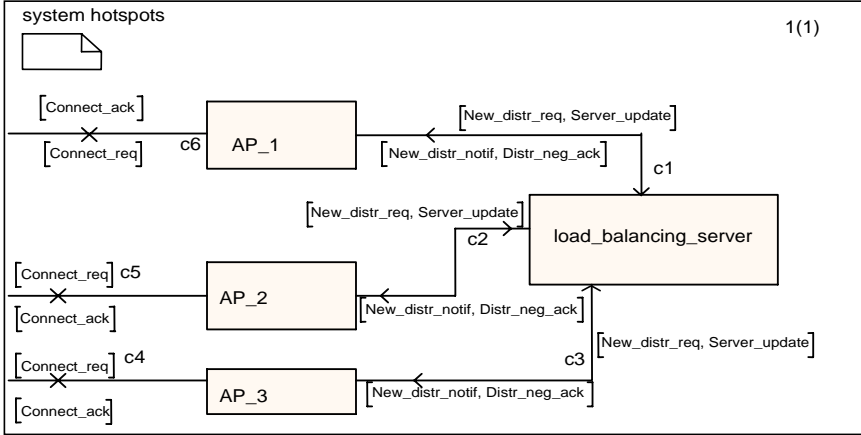

Fig. 6. SDL model of a hotspot topology

6.2 MSC Verification and Simulation

To check the QoS protocol behaviour based on the defined communication scenario (§4.2) we have used the ObjectGeode tool based on SDL and MSC. With SDL, we have validated the new primitives’ exchanges between access points and mobile stations. The Figure 7 brings out a part of simulation results of a QoS negotiation between the New_Station_Video, access points and the load balancing server. QoS requirements have to be set in the exchanges between the set of wireless entities.

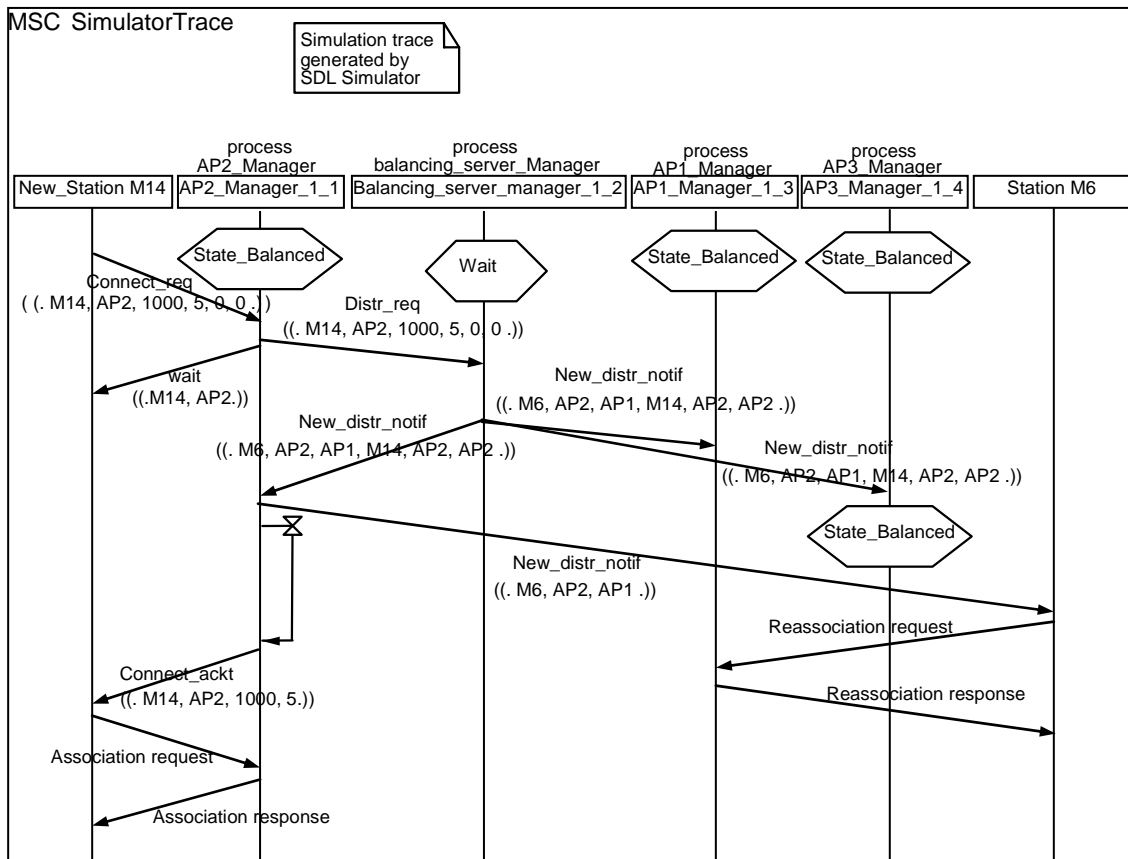

Fig. 7. MSC simulation of an example of exchange between wireless entities

The new station (M14) sends a *connect_req* frame to AP2 asking for a connection with 1000kbps as throughput and 5% as packet loss rate (this latter parameter is not yet considered in the load balancing). In this frame we can see that M14 is immobile and that AP2 is the only access point in range of M14. Since AP2 is not able to satisfy these QoS requirements, it sends a *wait* request to M14 and asks (*Distr_req*) the load balancing server for a new distribution of mobile stations among the available network access points. After running the load balancing algorithm, the server broadcasts a notification to access points with the new distribution of mobile stations. In this scenario, M6 has to reassociate from AP2 to AP1, so that M14 can associate to AP2. Access points have to inform their concerned stations that must start an 802.11 reassociation procedure. AP2 sends a *Connect_ack* frame to M14. This one starts an 802.11 association procedure.

With such MSC simulations we conclude that the elaborated SDL model is error free working and it can be tested with either a network simulator such as OPNET or in a real 802.11 network completed with our protocol.

7 Simulation Results

In order to study the performance of the load distribution approach we simulate the wireless LAN architecture described in section 4.2 using the OPNET Modeler 11.5. The simulated network topology contains 3 fixed AP, an Ethernet Switch, an application server and 14 mobile stations.

This wireless topology is simulated two times: with and without using the load balancing approach. Simulations lasted 180 seconds of simulated time. In the first simulation, M6_Video is associated to AP2. In this case the wireless LAN is then unbalanced. We run the load balancing algorithm to get a balanced load between access points. M6_Video should be now associated to AP1. In the second simulation, we simulate the wireless LAN with balanced access points loads.

In a first time, we try to monitor the global performances of the wireless LAN. Figure 8 plots the total size of higher layer data packets (in kbits/sec) dropped by all the WLAN MACs in the network due to full higher layer data buffer. The amount of global data dropped when the wireless LAN is not balanced is 6 times higher than when the wireless LAN is balanced.

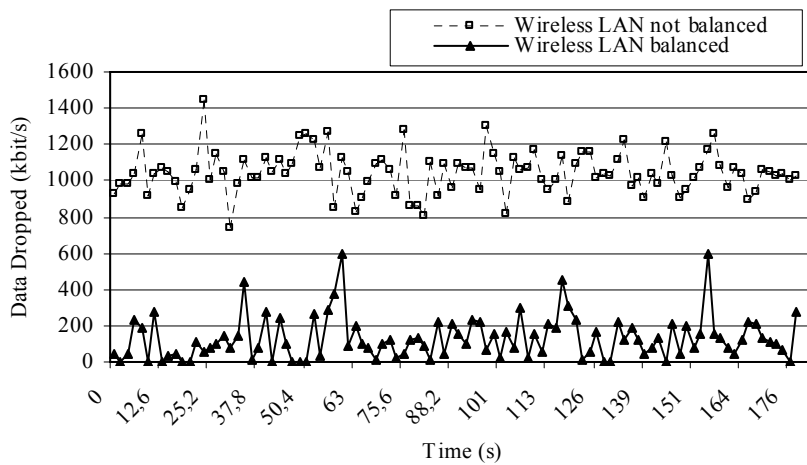

Figure 8 Global Data Dropped

Figure 9 shows that the global media access delay is better when the wireless LAN is balanced. Global media access delay represents the global statistic for the total of queue and contention delays of data packets received by all WLAN MACs in the network from higher layer. For each packet, the delay is recorded when the packet is sent to the physical layer for the first time.

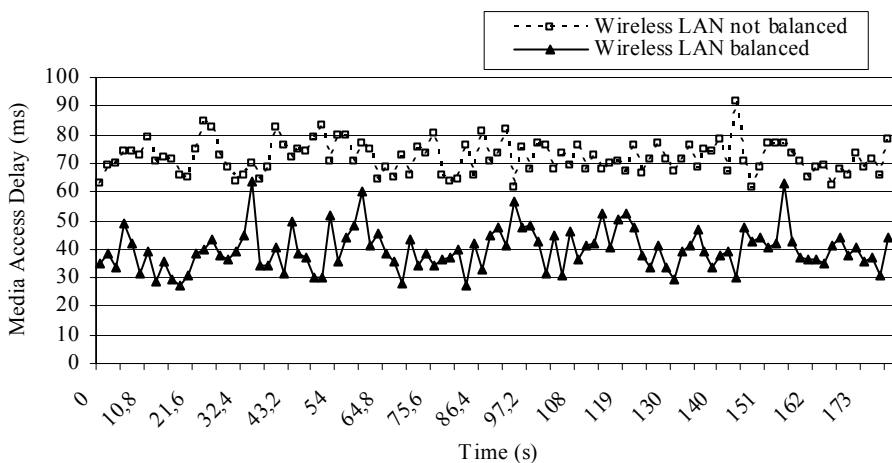

Figure 9 Global Media Access Delay

Figure 10 represents the total number of bits (in kbits/sec) forwarded from wireless LAN

layers to higher layers in all WLAN nodes of the network. We can observe that the load that has been routed by AP1, AP2 and AP3 to the destination server is greater when the wireless LAN is balanced.

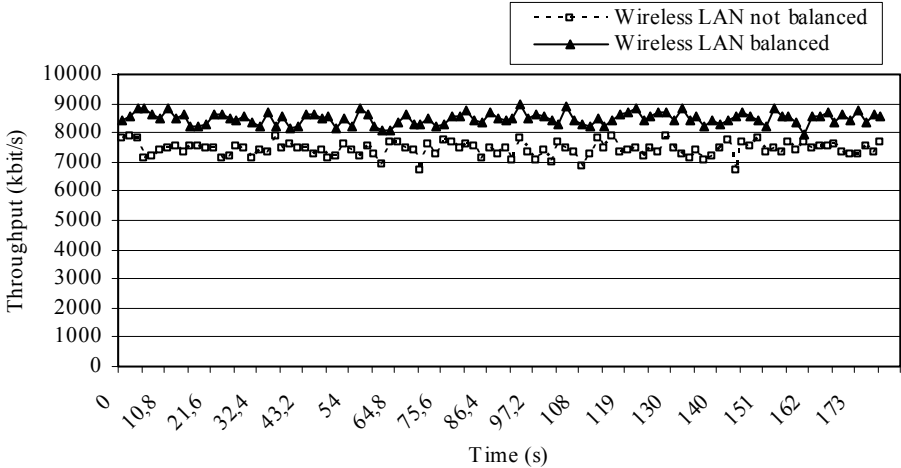

Figure 10 Global Throughput

We can conclude that using load balancing approach provides better global performances in the wireless LAN. With a load balanced wireless LAN, it is possible to associate a higher number of wireless stations and enhance the global QoS parameters in the same time.

We have also tried to monitor some parameters locally at the level of the two access points AP1 and AP2. Figures 11 and 12 illustrate the average delay respectively at access points AP1 and AP2. This delay includes queueing and medium access delays at the source MAC, reception of all the fragments individually, and the relay of the frame via AP, if the source and destination MACs are non-AP MACs of the same infrastructure BSS. When the wireless LAN is not balanced, we observe that the average delay for packets successfully received by AP2 is

always greater than 0,12 seconds where it is less then 0,01 second in the Basic Service Set covered by AP1. By balancing the load among access points, the delays corresponding to the two BSS became comparable with a mean value almost equal to 45 ms. While avoiding violating the “contracts” of QoS of the stations associated with AP1, it was interesting to balance the loads in order to have reasonable delays for the stations attached to AP2.

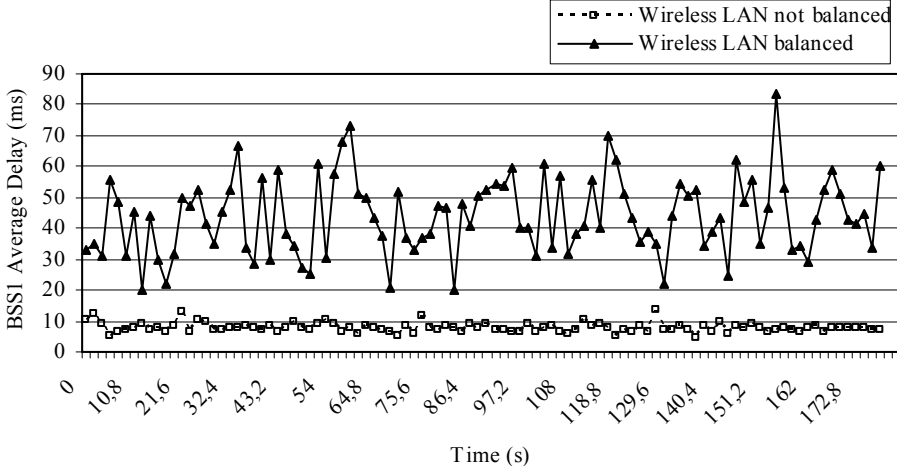

Figure 11 BSS1 Average Delay

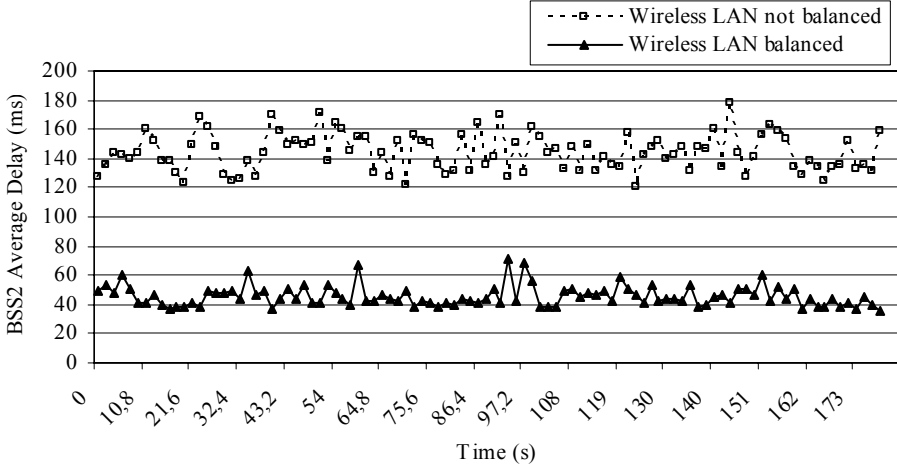

Figure 12 BSS2 Average Delay

We can also observe that by balancing access points loads their respective SNR become comparable (Figures 13 and 14). SNR represents the ratio of the average power of a packet segment being received at a receiver channel and the combined average power of all relevant interference sources. According to the simulations parameters (Transmit power and Packet Reception-power threshold) carried out we know that it is possible to have a communication between two entities of the wireless network only if the SNR of the received packets is higher than 10,64 dbm. In spite of the fall of this parameter on the level of the access point AP1, we see well that the values obtained after load balancing are always acceptable to have a communication with the set of mobile stations.

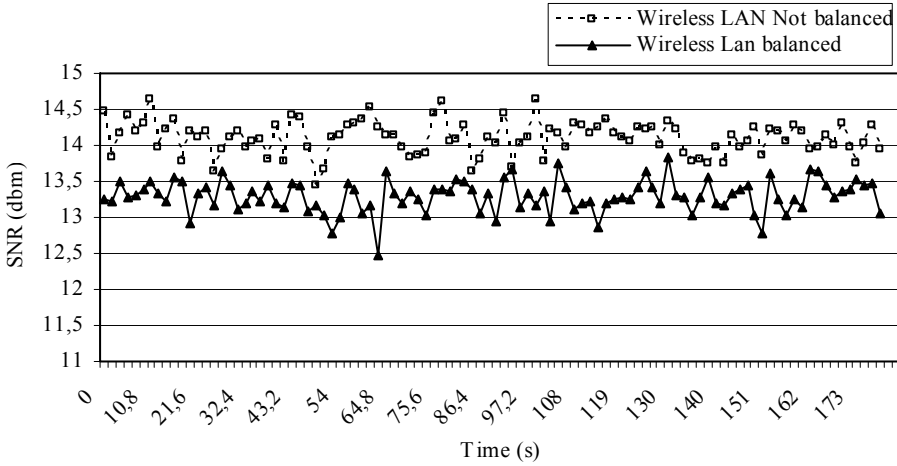

Figure 13 AP1 SNR

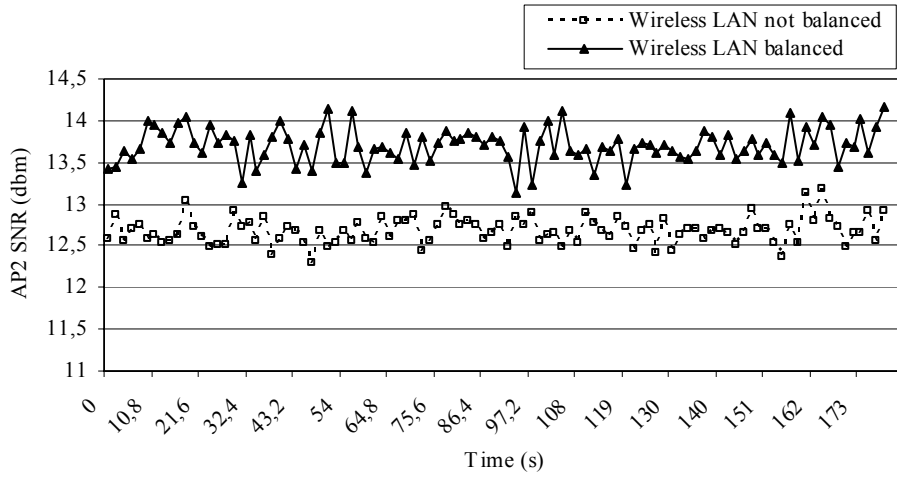

Figure 14 AP2 SNR

We also recovered some QoS parameters on the level of the mobile stations. Figures 15, 16 and 17 illustrate the media access delay for New_station_Video, M6_Video and M3_Voice stations.

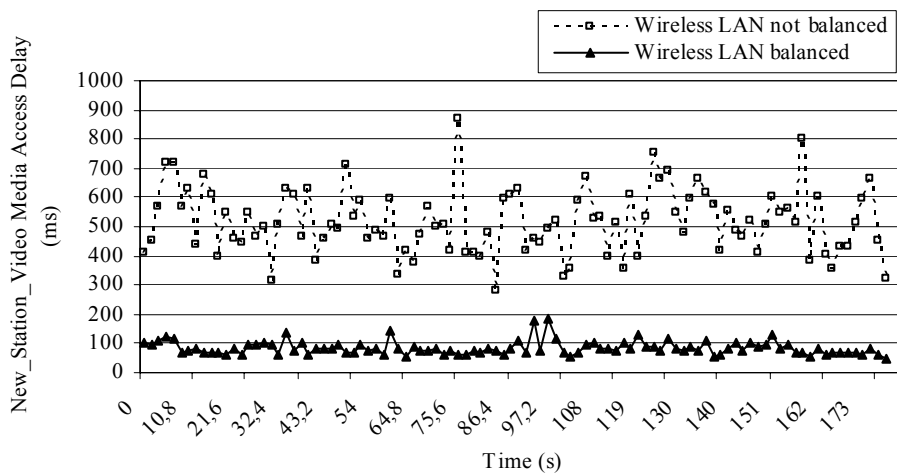

Figure 15 New_Station_Video Media Access Delay

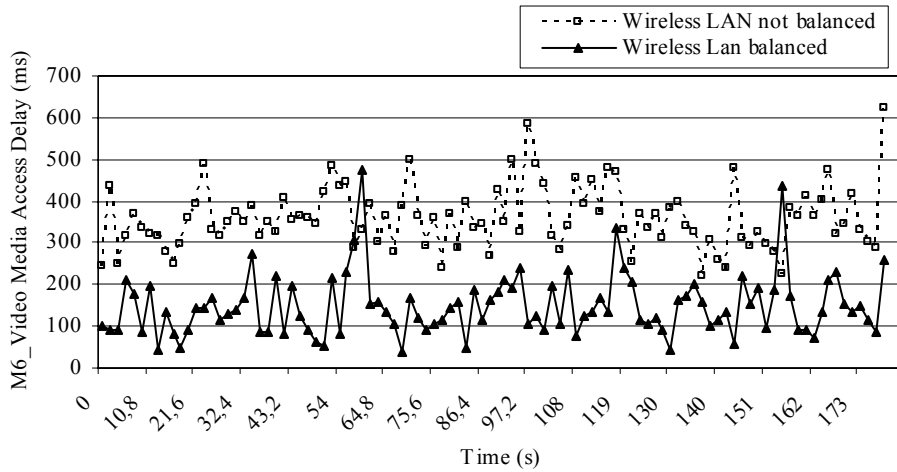

Figure 16 M6_Video Media Access Delay

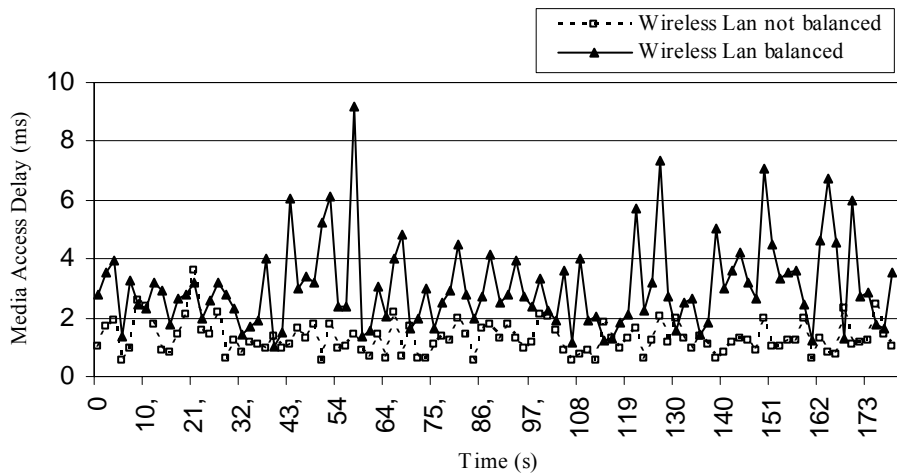

Figure 17 M3_Voice Media Access Delay

We observe that load balancing has reduced almost 7 times the media access delay for the new associated station. It's in the neighbourhoods of 90 ms which seems acceptable for video traffic. We can also see that media access delay is also reduced for M6_Video station which is reassociated from AP2 to AP1.

For the station M3_Voice which always remained associated to AP1 before and after the load balancing, the media access delay slightly increased. It's in the neighbourhoods of 3 ms with a peak of 9 ms. These values remain always adequate for a voice transmission.

8 Conclusion and Future Works

This paper addresses the problem of QoS management in the WLAN. It presents a new load balancing approach to enhance the QoS perceived by the 802.11 wireless users. We used the OPNET simulator to show the better performances of the global wireless LAN when this approach is applied to a hotspot environment. By fairly distributing mobile stations among different access points according to their load, individual QoS parameters are also enhanced for wireless users. In this paper, we also present a protocol specification between mobile stations and access points to negotiate QoS requirements during the mobile station attachment. This protocol defines some new primitives related to the QoS management that must operate with the IEEE 802.11. The specification of these protocol primitives has been carried out. An SDL description with MSC simulations shows the behavior verification of this protocol.

Further works will focus on the study of constraints and possibilities to implant the load balancing algorithm and new specified exchanges between the different wireless entities into a real IEEE 802.11 platform. Some values of the *Type* and *Sub_type* fields of the generic 802.11 management frame are not used and may be assigned to include the new defined primitives.

Acknowledgement

This work has been performed with the finance support of the CMCU project: an integrated action between Tunisian and French research Ministries. This project aims the study of QoS management in distributed systems.

References

1. Balachandran, A., Voelker, G.M., Bahl, P., Rangan, P.V.: Characterizing User Behavior and Network Performance in a Public Wireless LAN. ACM SIGMETRICS Int. Conference on Measurement and Modelling of Computer Systems. Marina Del Rey, California (2002)
2. Balachandran, A., Voelker, G.M., Bahl, P.: Hot Spot Congestion Relief in Public-Area Wireless Networks. 4th Workshop on Mobile Computing Systems and Applications. Callicoon, New York, USA (2002) 70-80
3. Matthew, S. G.: 802.11 Wireless Networks : The Definitive Guide. 1st edn. O'Reilly and associates Inc (2002)
4. Gotzhein, R., Schaible, P.: Pattern-based Development of Communication Systems. Annales Télécommunication, N° 54 (1999)
5. Probert, R.L., Ural, H., Williams, A.W.: Rapid Generation of Functional Tests Using MSCs, SDL and TTCN. Computer Communications, Vol. 24 No. 3-4. Elsevier (2001) 374–393
6. Chiu, Dah-Ming, Jain, : Analysis of the Increase and Decrease Algorithms for Congestion Avoidance in Computer Networks. Journal of Computer Networks and ISDN, Vol. 17, N. 1. (1989) 1-14
7. Ni, Q., Romdhani, L., Tureletti, T.: A Survey of QoS Enhancements for IEEE 802.11 Wireless LAN. Journal of Wireless Communications and Mobile Computing, Vol. 4, Issue 5. John Wiley and Sons Ltd (2004) 547-566
8. Lin, C. R., Gerla, M.: Real Time Support in Multihop Wireless Networks. ACM Wireless Networks, Vol. 5, N. 2. ACM (1989) 125-135
9. I. Jabri, N. Kromenacker, A. Soudani and T. Divoux, Load Balancing Approach for wireless IEEE 802.11 QoS Enhancement, Personal Wireless Communications, Lecture Notes in Computer Science, ISBN 978-3-540-45174-7, 2006, pp 88-99.

10. Velayos, H., Aleo, V., Karlsson, G.: Load Balancing in Overlapping Wireless Cells. International Conference on Communications. IEEE, Paris, France (2004)
11. Bianchi, G., Tinnirello, I.: Improving Load Balancing Mechanisms in Wireless Packet Networks. Int. Conference on Communications. IEEE, New York, USA (2002) 891-895
12. Lindgren, A., Almquist, A., Schelen, O.: Quality of Service Schemes for IEEE 802.11 Wireless LANs – An Evaluation. Mobile Networks and Applications, Vol. 8, N°. 3, Springer (2003) 223-235.
13. Mangold, S., S. Choi, G. R. Hiertz, O. Klein, B. Walke. Analysis of IEEE 802.11e for QoS support in wireless LANs. Wireless Communications, Vol. 10, N°. 6, IEEE (2003) 40-50.
14. IEEE 802.11 - Part 11: Wireless Medium Access Control (MAC) and Physical Layer (PHY) specifications: Medium Access Control (MAC) Enhancements for Quality of Service (QoS), IEEE 802.11e/Draft 4.2. (2003)
15. Zhu, H., Li, M., Chlamtak, I., Prabhakaran, B.: A survey of Quality of Service in IEEE 802.11 Networks. Wireless Communications, Vol. 11, No. 4. IEEE (2004) 6-14
16. Pattara-Atikom, W., Krishnamurthy, P., Banerjee, S.: Distributed Mechanisms for Quality of Service in Wireless LAN. Wireless Communications, Vol. 10. IEEE (2003) 26-34
17. Sheu, S. T., Wu, C. C.: Dynamic Load Balance Algorithm (DLBA) for IEEE 802.11 wireless LAN. Tamkang Journal of Science and Engineering, Vol. 2, No. 1, (1999) 45-52.
18. Brickley, O., Rea, S., Pesch, D.: Load balancing for QoS enhancement in IEEE802.11e WLANs using cell breathing techniques. 7^{ème} IFIP International Conference on Mobile and Wireless Communications Networks, Maroc (2005).
19. Zhao, D., Zou J., Todd, T. D.: Admission control with load balancing in IEEE 802.11-based ESS mesh networks. Wireless Networks, Vol. 13, Springer (2007) 351-359.

20. Gallardo, J. R., Medina, P., Zhuang, W.: QoS Mechanisms for the MAC protocol of 802.11 WLANs. *Wireless Networks*, Vol. 13, Springer (2007) 335-349.
21. Cali, F., Conti, M., Gregori, E.: Dynamic IEEE 802.11: design, modeling and performance evaluation. *Journal of Selected Areas in Communications*, Vol. 18, No. 9, IEEE (2000) 1774-1786.
22. Xiao, Y.: Performance analysis of priority schemes for IEEE 802.11 and IEEE 802.11e wireless LANs. *Transactions on Wireless Communications*, Vol. 5, N°. 4, IEEE (2005) 1506-1515.