



HAL
open science

Estimation of Direction of Arrival (DoA) of DVB T signals in mobile receiving configuration

Franck Nivole, Christian Brousseau, Stéphane Avrillon, Dominique Lemur,
Louis Bertel

► **To cite this version:**

Franck Nivole, Christian Brousseau, Stéphane Avrillon, Dominique Lemur, Louis Bertel. Estimation of Direction of Arrival (DoA) of DVB T signals in mobile receiving configuration. Communications 2008 - 7th IEEE International Conference on Communications, Jun 2008, Bucarest, Romania. pp.203-206. hal-00322936

HAL Id: hal-00322936

<https://hal.science/hal-00322936>

Submitted on 19 Sep 2008

HAL is a multi-disciplinary open access archive for the deposit and dissemination of scientific research documents, whether they are published or not. The documents may come from teaching and research institutions in France or abroad, or from public or private research centers.

L'archive ouverte pluridisciplinaire **HAL**, est destinée au dépôt et à la diffusion de documents scientifiques de niveau recherche, publiés ou non, émanant des établissements d'enseignement et de recherche français ou étrangers, des laboratoires publics ou privés.

ESTIMATION OF DIRECTION OF ARRIVAL (DOA) OF DVB-T SIGNALS IN MOBILE RECEIVING CONFIGURATION

F. Nivole, C. Brousseau, S. Avrillon, D. Lemur, L. Bertel

IETR, Institut d'Electronique et de Télécommunications de Rennes , Université de Rennes 1
 Campus de Beaulieu, 35042, RENNES Cedex, FRANCE
 phone: + (33) 2 23 23 62 31, fax: + (33) 2 23 23 56 16, email: christian.brousseau@univ-rennes1.fr
 web: www.ietr.org

ABSTRACT

To improve the quality of the mobile reception of DVB-T (Digital Video Broadcasting on Terrestrial networks) signal, the knowledge of the propagation channel characteristics is necessary. In this aim, this paper presents sounding methods and results for the estimation of Direction of Arrival (DoA) of DVB-T signals in mobile receiving configuration. The mobile passive sounder is presented, including post-processing and radio direction finding tools. Then several results in three kinds of environment are given.

1. INTRODUCTION

The aim of the CAVITE project [1] is to improve the reception of DVB-T signal in mobile conditions (car, train ...) characterized by important propagation effects (Doppler, delay spread ...). The first step of this project is to evaluate the spatial and time propagation channel characteristics, to ensure that diversity exists and that it could be exploited to increase the quality of received images on vehicular board.

DVB-T (Digital Video Broadcasting on Terrestrial networks) system uses COFDM transmission. This modulation is suitable to high numerical data rate transmission but is very sensitive to Doppler frequency shift, noise and fading effects. One way to improve the DVB-T reception for mobile application, like car, train..., is to use heterogeneous antennas array. The choice of these antennas is critical and it is necessary to have a good knowledge of the propagation channel effect. In particular, the estimation of the Direction of Arrival (DoA) allows to define the features of the antennas [2] and their location on the vehicle.

2. MULTI-ANTENNA MOBILE SOUNDER AND SIGNAL PROCESSING

2.1 DVB-T French Broadcast System

The COFDM DVB-T system in France uses the parameters [3] described in table 1, with a sampling rate equals to $7/64 \mu s$.

The parameters are done for static reception. The guard interval is not suitable to great time delay between DVB multipaths, and the 64 QAM modulation needs a high SNR level to provide a good reception quality.

Mode	8 k
Guard interval	256 x sampling rate
Symbol duration	8192 x sampling rate
Total symbol duration	8448 x sampling rate
Modulation	64 QAM

Table 1: List of COFDM DVB-T parameters.

The network is a Multi-Frequency Network (MFN) with large distance between transmission stations and with different frequency plans for the same TV program in each part of country.

2.2 Description of multi-antenna passive sounder

The diversity receiving system uses four coherent super heterodyne receivers built in the laboratory. The phase coherence is necessary for direction finding algorithms, because they use the geometric phases of the antenna array to estimate the Direction of Arrival (DoA).

The first stage is shown in figure 1. Each input uses a RF band pass filter and a Low Noise Amplifier (LNA) to ensure good conditions of reception.

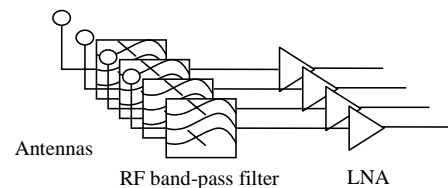

Figure 1: Input RF first stage.

Following the first stage, a mixer and a RF generator used as local oscillator down-convert the RF frequency to an intermediate frequency of 36.125 MHz (figure 2). The interferences and analog TV are cut-off by a SAW filter.

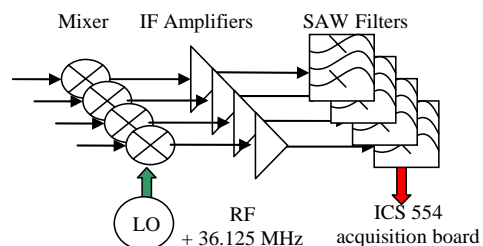

Figure 2: Input RF second stage.

Then, an amplifier in each channel matches the output signal level to the desired input level of the ICS 554 data acquisition board. Finally, a quadrature down conversion is done to ensure complex data processing. The down converter has a sampling rate of 100 Ms/s. The used decimation ensures a rate of 25 Ms/s (a resampling to the DVB-T FFT sampling rate is done by software to get about 9.145 Ms/s of sampling rate). Photo of the RF front-end and acquisition systems are shown in the figure 3.



Figure 3: Receiving and acquisition system.

Many antennas have been developed and tested [4]: big wheel, patch and patch array, wideband dipole, pie-shaped, halo and printed halo antenna array, and loop antenna. Regarding the channel sounding requirements, an array of 2 halo printed antennas has been chosen because:

- Features can be kept between each realized antenna,
- Gain of array allows good reception,
- Omni-directionality is ensured,
- Antennas size is suitable for multi-antenna array.

Halo dimension features are described in figure 4 and the figure 5 shows the twice coupled antenna.

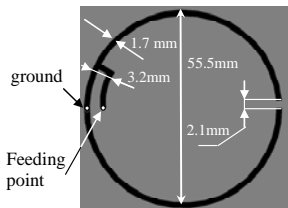

Figure 4: Halo Antenna on FR4 substrate.

To characterize the DVB-T propagation channel, a circular array of 4 pairs of printed halo antenna is used (figure 5). The figure 6 shows the azimuth and elevation configuration regarding network and antenna input number.

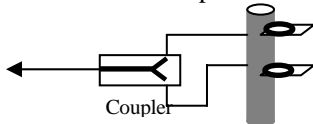

Figure 5: Twice printed halo antenna with coupler.

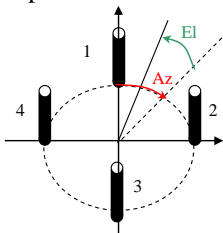

Figure 6: Array configuration.

2.3 Acquisition and post-processing software

The input signals are obtained from DVB-T broadcasted signal in mobile configuration. The system uses ICS554 acquisition card that gives several snapshots of broadcasted symbols. The post processing is performed with software developed by laboratory [4], according to the recommendations of [5]. Figure 7 shows the man machine interface done to simplify the use of the post-processing software.

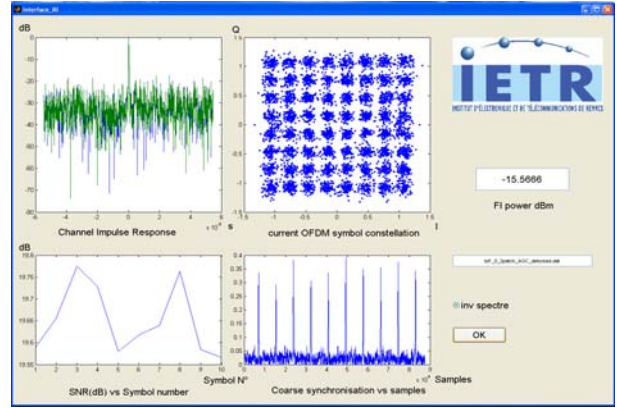

Figure 7: IETR tools for DVB-T demodulation.

The data which appear in this interface are:

- Measured channel impulse response,
- Measured OFDM constellation,
- SNR as a function of symbol,
- Coarse synchronization as a function of sample.

Then, the tools give the number of paths that can be found inside OFDM DVB-T signal. To improve the reception of DVB-T signal, analysis is then done by a radio direction finding estimation (DoA) to select the suitable antennas and their best locations and orientations. DoA analysis is done with two algorithms, first is the Capon method and the second is the MUSIC high resolution algorithm.

2.4 Radio direction finding tools

2.2.1 Capon method

The Capon method algorithm [6] uses the covariance matrix of samples vectors X:

$$R_{XX} = \frac{1}{N} \sum_{n=1}^N X(n)X(n)^T \quad (1)$$

Where n is the sample number, N, the number of samples, and \cdot^T , the transposition.

Then, the Capon spectrum is given by:

$$P_{capon}(Az, El) = \frac{1}{a(Az, El)^T \cdot R_{XX} \cdot a(Az, El)} \quad (2)$$

Where Az is the azimuth angle, El, the elevation angle, and a, the steering vector of the antenna array.

2.2.1 MUSIC high resolution algorithm

This algorithm [7] uses an eigen-decomposition of the covariance matrix R_{XX} (Eq. 1). The aim is to separate the samples in two orthogonal subspaces. The first is the noise subspace and the second is the signal one.

After the decomposition, the number of sources NSE is evaluated by the most important Eigen values. Then, a pseudo spectrum PSSP is determined using the normalized steering vector $b(Az, El)$ of antenna array. It is given by:

$$PSSP(Az) = \frac{1}{\sum_{k=NSE+1}^{NC} |v_k^T \cdot b(Az, El)|} \quad (3)$$

Where NC is the number of sensors, k, the sensor number, v_k^T , the eigenvector and $b = a/(NC)^{1/2}$, the normalized steering vector.

The maximum as a function of azimuth and elevation angles gives the DoA of DVB-T propagation paths.

3. FIELD TESTS

For the measurements, a car was equipped with the 4 inputs diversity receiver and the antennas were mounted on the vehicle in a roof box. Figure 8 shows the embedded mobile system inside the car. The diversity sounder uses broadcasted DVB-T received signals from the "Rennes-Saint Pern" TDF (Télédiffusion De France) transmitter in Brittany (France), to measure channel propagation characteristics. It is an MFN network with no cellular condition because only one transmitter is used in this part of the country.



Figure 8: Photo of the embedded system inside the car.

By using a GPS receiver, the routes of mobile tests are recorded. In order to provide useful measurements, some different routes have been selected like motorway, rural and town center. Figure 9 shows the route recorded by the GPS receiver and the direction of the vehicle along these routes.

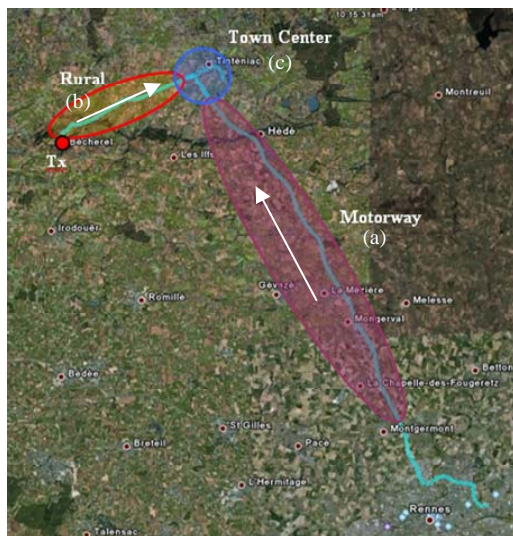

Figure 9: Measurements routes recorded by the GPS receiver.

4. RESULTS OF ESTIMATION OF DOA

The results are given for each method (Capon and MUSIC), with a polar histogram which shows the number of redundancies that are obtained during each snapshot. Figure 10 and 11 give the reference azimuth and elevation regarding the vehicle orientation.

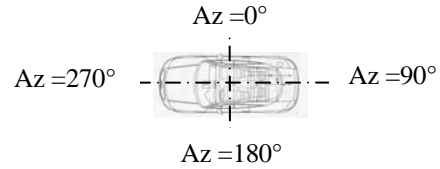

Figure 10: Car representation in azimuth plan.

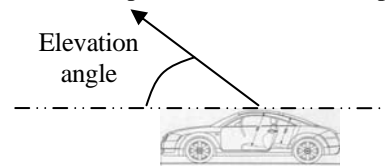

Figure 11: Car representation in elevation plan.

The angles of arrival are analyzed in the three cases (figure 9):

- Motorway with a speed limit of 110 km/h: figures 12 and 13,
- Rural road (speed limit of 90 km/h): figures 14 and 15,
- Town center (speed limit of 50 km/h): figures 16 and 17.

5. RESULTS COMMENTS

The angular distribution is concentrated around the predominant line of sight. In other cases, the demodulation is not possible, because the signal is often shadowed, and the signal to noise ratio is too weak. The most important reflections are not seen in this diagram because they are arriving in the same mean angle of the direction. One dominant path is observed with many diffused paths around the main angle of arrival.

So to have good reception in all the azimuth space, one antenna with omnidirectional radiation pattern, or several directional antennas located in each side of the vehicle can be used. In all cases, antennas must have a high radiation pattern gain to have a sufficient signal to noise ratio to demodulate COFDM signal, which is not a compatible constraint with omnidirectional antenna feature, and an aperture over the 20° of elevation angle.

6. CONCLUSION

A passive channel sounder has been developed to measure the Direction of Arrival (DoA) of DVB-T signals in mobile receiving configuration. Distribution of the angles of arrival in three kinds of areas (motorway, rural and town center) is concentrated around a main direction with a low angular spread. In this case, omnidirectional reception is not suitable. One solution is to use several high gain directional antennas which have to be distributed in all 360° direction.

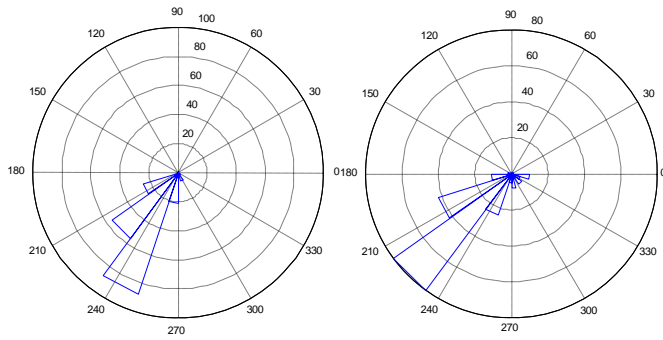

Capon Music

Figure 12: Azimuth angle results in motorway area.

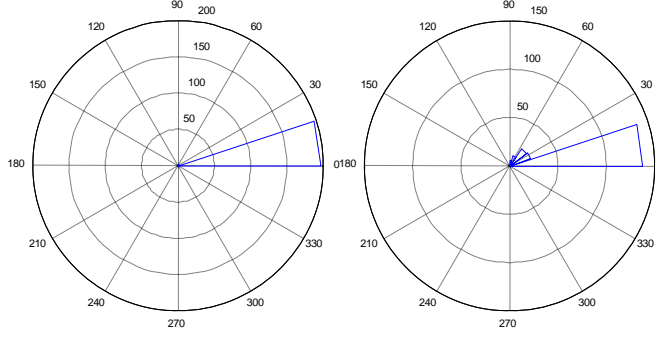

Capon Music

Figure 13: Elevation angle results in motorway area.

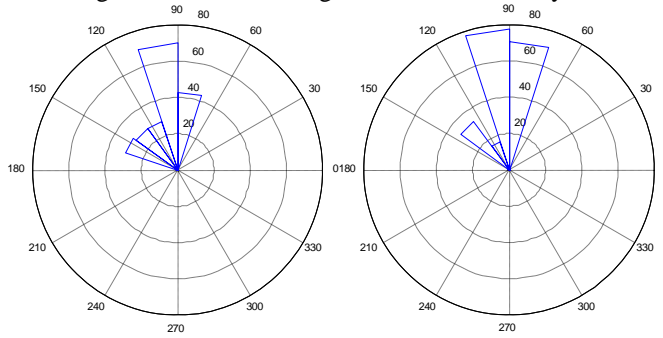

Capon Music

Figure 14: Azimuth angle results in rural area.

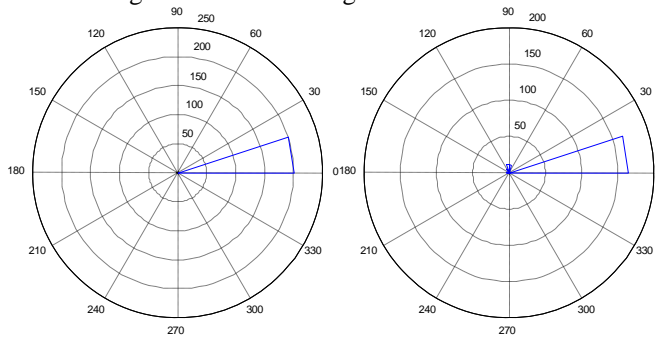

Capon Music

Figure 15: Elevation angle results in rural area.

Regarding this fact, the receiver does not need to use several synthesizers at the same time, because paths are not distributed in the all azimuth space at the same time. The consumption can be reduced but a regular scan to get quality of signal has to be done to choose the antenna which has to be used.

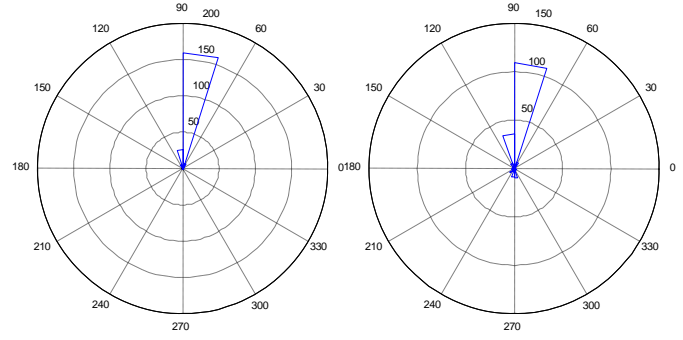

Capon Music

Figure 16: Azimuth angle results in town center.

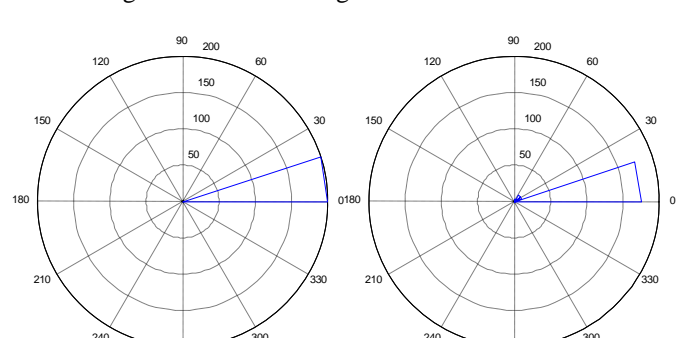

Capon Music

Figure 17: Elevation angle results in town center.

ACKNOWLEDGEMENTS

The authors thank the Council of Brittany - France (Conseil Régional de Bretagne) and the FNADT (Fonds National d'Aménagement et de Développement du Territoire) for their supports to this project.

REFERENCES

- [1] C. Brousseau, S. Avrillon, F. Nivole, L. Bertel, "Vectorial characterization of DVB-T propagation channel – Application to radio-Mobile communications: the "CAVITE" Project", in *Proc. EUCAP2007*, Edinburgh, UK, Nov. 2007.
- [2] Y. Erhel, D. Lemur, L. Bertel, F. Marie, "H.F. radio direction finding operating on a heterogeneous array: principles and experimental validation", *Radio-Science*, n°1, 2004.
- [3] ETSI, "Digital Video Broadcasting system for television, sound and data services: Draft ETS 300 744", March 1997.
- [4] F. Nivole, C. Brousseau, S. Avrillon, D. Lemur, F. Marie, L. Bertel, "Comparison of antennas performances for COFDM DVB-T system – Application to channel sounding", in *Proc. EUCAP2007*, Edinburgh, UK, Nov. 2007.
- [5] P. Combelles, C. Del Toso, D. Hepper, D. Legoff, J-J. Ma, P. Roberston, F. Scalise, L. Soyer, M. Zamboni, "A receiver architecture conforming to the OFDM based digital video broadcasting standard for terrestrial transmission (DVB-T)", in *Proc. ICC'98*, Torino, Italy, June 1998.
- [6] J. Capon, "Maximum-likelihood spectral estimation", Springer-Verlag, 1979.
- [7] R.O. Schmidt, "Multiple Emitter Location and Signal Parameter Estimation", *IEEE Transactions on Antennas and Propagation*, Vol. AP-34, N°3, March 1986.