



HAL
open science

A micro-macro and parallel computational strategy for highly heterogeneous structures

Pierre Ladevèze, Olivier Loiseau, David Dureisseix

► **To cite this version:**

Pierre Ladevèze, Olivier Loiseau, David Dureisseix. A micro-macro and parallel computational strategy for highly heterogeneous structures. *International Journal for Numerical Methods in Engineering*, 2001, 52 (1-2), pp.121-138. 10.1002/nme.274 . hal-00322459

HAL Id: hal-00322459

<https://hal.science/hal-00322459>

Submitted on 18 May 2015

HAL is a multi-disciplinary open access archive for the deposit and dissemination of scientific research documents, whether they are published or not. The documents may come from teaching and research institutions in France or abroad, or from public or private research centers.

L'archive ouverte pluridisciplinaire **HAL**, est destinée au dépôt et à la diffusion de documents scientifiques de niveau recherche, publiés ou non, émanant des établissements d'enseignement et de recherche français ou étrangers, des laboratoires publics ou privés.

A micro-macro and parallel computational strategy for highly-heterogeneous structures

P. Ladevèze*, O. Loiseau and D. Dureisseix

LMT-Cachan (ENS Cachan / CNRS / Université Paris VI), 61 Avenue Président Wilson, F-94235 Cachan CEDEX, France

Abstract

A new micro-macro computational strategy is proposed for the analysis of structures which are described up to the micro level, such as composite structures. The description of micro and macro quantities is performed on the interface arising from the decomposition of the structure into an assembly of substructures and interfaces. A traction-based version of the micro-macro strategy is described and the influence of the numerical parameters as well as the performance of the approach are discussed.

This is the post-print accepted version of the following article: D. Dureisseix, P. Ladevèze, B. Schrefler, A LATIN computational strategy for multiphysics problems: Application to poroelasticity. *International Journal for Numerical Methods in Engineering* 56(10):1489-1510, Wiley-Blackwell, 2003, DOI: 10.1002/nme.622, which has been published in final form at <http://http://onlinelibrary.wiley.com/doi/10.1002/nme.622/abstract>

Keywords: homogenization; domain decomposition; multilevel; LATIN method

1 INTRODUCTION

When analyzing heterogeneous structures, such as reinforced or composite structures, and when a refined solution is required, the computation must involve a fine discretization of the structure (at the micro-level). Since the constituents often exhibit very different mechanical characteristics, the resulting structure is highly heterogeneous and the local solution displays high gradient areas, effects with a short length of variation, *etc.* This situation leads to problems with a large number of degrees of freedom. Computational strategies have been developed in order to the resolution costs for such problems low. The theory of periodic media homogenization [1] is one such strategy. Further developments for associated computational approaches can be found in [2, 3, 4]. The macro-level solution yields the effective values of the unknowns; the micro-level solution must be recomputed with a specific treatment of the boundary areas as distinct from the interior areas. Of course, the fundamental assumption in the use of this method lies in the fact that the ratio of the small-scale length to the large-scale length has to be small. Moreover, these techniques are not really suited to non-linear problems of evolution, in which they are applied to linear problems arising from successive linearizations related to the computational strategy.

The objective of the micro-macro approaches developed herein, following previous developments [5, 6], is to avoid several of the limitations in classical homogenization techniques and to accommodate the most powerful computing resources used today, *i.e.* parallel architecture computers. This iterative strategy has a strong mechanical basis; it is built upon characteristic properties which are satisfied by structural models described up to the micro-scale.

The first step is the decomposition of the structure into an assembly of simple constituents: substructures and interfaces. For instance, a substructure may contain one or several cells of a composite structure. Each of these components possesses its own variables and equations. An interface transfers both a distribution of displacements and a distribution of forces.

The novelty, with respect to our earliest work [7], is the splitting of the unknowns (displacements, forces, stress, strain) into the form:

$$s = s^M + s^m$$

*Corresponding author

where s^M is the set of the macroscopic quantities and s^m is the additive “micro” complement. Several descriptions are conceivable. Here, we consider descriptions related to a “continuum-medium” point of view, and we feature a general method for homogenization and local re-analysis. A first description, which is displacement-based, has been introduced in [5, 6]. We introduce here a new traction-based description.

The second step of this micro-macro strategy is the use of the so-called LATIN Method on the problem expressed as an assembly of substructures and interfaces to be solved. The LATIN Method is a non-incremental iterative computational strategy applied over the entire studied time interval [7]. The resultant micro-macro strategy displays convergence for stable materials under standard assumptions. In order to focus on the main concepts, this method will be described herein only for linear elasticity.

At each iteration, one has to solve a “macro” problem, defined on the entire structure, along with a family of linear problems, each one of which has independent substructure and interfaces. These are the “micro” problems, whereas the “macro” problem is related to the entire homogenized structure. For linear problems, this strategy involves numerical parameters that can be interpreted as interface stiffnesses. A study of the influence of these numerical parameters on both the displacement-based and traction-based micro-macro asymptotical strategies is reported. The conclusion is remarkable: the two approaches are identical for the best values of the numerical parameters. Moreover, only one numerical parameter remains, which can be interpreted as the micro stiffness of the interface. Several numerical examples for composite structures illustrate the possibilities of the present approach.

This overall scheme is well suited to parallel architecture computers. It can be considered as a mixed domain decomposition method. An initial version, adapted to slightly heterogeneous structures, has been reported in [8]. This version is *a priori* less efficient than the present micro-macro computational strategy, yet remains comparable to the FETI domain decomposition method [9], which today is the reference within the field of parallelism. This use of two scales or two grids pertains to other methods as well, such as multigrid methods, in which the basis is essentially numerical and quite distinct from the “homogenization” orientation of the field of mechanics.

2 THE REFERENCE PROBLEM AND ITS RE-FORMULATION

The reference problem is related to the quasi-static behavior of a structure, denoted by Ω , for small perturbations and isothermal evolution. The loadings are:

- a prescribed displacement \underline{U}_d on an initial part of the boundary $\partial_1\Omega$,
- a prescribed traction force \underline{F}_d on the complementary part of the boundary $\partial_2\Omega$,
- a prescribed body force \underline{f}_d on Ω .

For the sake of simplicity, only the case of linear elasticity will be discussed herein. Therefore, only the final configuration is of interest, and time is no longer taken into account. The non-linear case is discussed in [10].

The current state of the structure is given by the stress field $\boldsymbol{\sigma}$ and the displacement field \underline{U} at each point \underline{M} of Ω . $\boldsymbol{\sigma}$ is searched in the corresponding space \mathcal{S} , while \underline{U} is searched in \mathcal{U} . The problem to be solved then is to find $s = (\underline{U}, \boldsymbol{\sigma})$ in $\mathcal{U} \times \mathcal{S}$ which satisfies:

- kinematic admissibility equations:

$$\begin{aligned} \underline{U} &\in \mathcal{U} \\ \boldsymbol{\varepsilon} &= \boldsymbol{\varepsilon}(\underline{U}), \quad \underline{U}|_{\partial_1\Omega} = \underline{U}_d \end{aligned}$$

where $\boldsymbol{\varepsilon}$ is the strain field.

- equilibrium equations:

$$\begin{aligned} \boldsymbol{\sigma} &\in \mathcal{S} \\ \forall \underline{U}^* \in \mathcal{U}_0, \quad \int_{\Omega} \text{Tr} [\boldsymbol{\sigma} \boldsymbol{\varepsilon}(\underline{U}^*)] d\Omega &= \int_{\Omega} \underline{f}_d \cdot \underline{U}^* d\Omega + \int_{\partial_2\Omega} \underline{F}_d \cdot \underline{U}^* |_{\partial_2\Omega} \end{aligned}$$

where \mathcal{U}_0 is the set of kinematically-admissible displacement fields with null conditions on $\partial_1\Omega$.

- the constitutive relation:

$$\boldsymbol{\sigma} = \mathbf{K}\boldsymbol{\varepsilon}$$

where $\mathbf{K}(\underline{M})$ is the Hooke’s tensor, characterizing the local material behavior.

The first step of the micro-macro strategy is the re-formulation of the problem in terms of a decomposition of the structure into an assembly of simple constituents: substructures and interfaces [7] (see Figure 1). Each of these components possesses its own variables and equations.

A substructure Ω_E , $E \in \mathbf{E}$, is submitted to the action of its environment (its neighboring interfaces): a traction field \underline{F}_E and a displacement field \underline{W}_E on its boundary $\partial\Omega_E$.

An interface $\Gamma_{EE'}$ between substructures E and E' transfers both the displacement field and traction field on each side: $\underline{W}_E, \underline{W}_{E'}$ and $\underline{F}_E, \underline{F}_{E'}$. The corresponding spaces are then $\mathcal{W}_{EE'}$ and $\mathcal{F}_{EE'}$. Extended to all the interfaces, they become \mathcal{W} and \mathcal{F} . Since both the displacement and forces on the interfaces

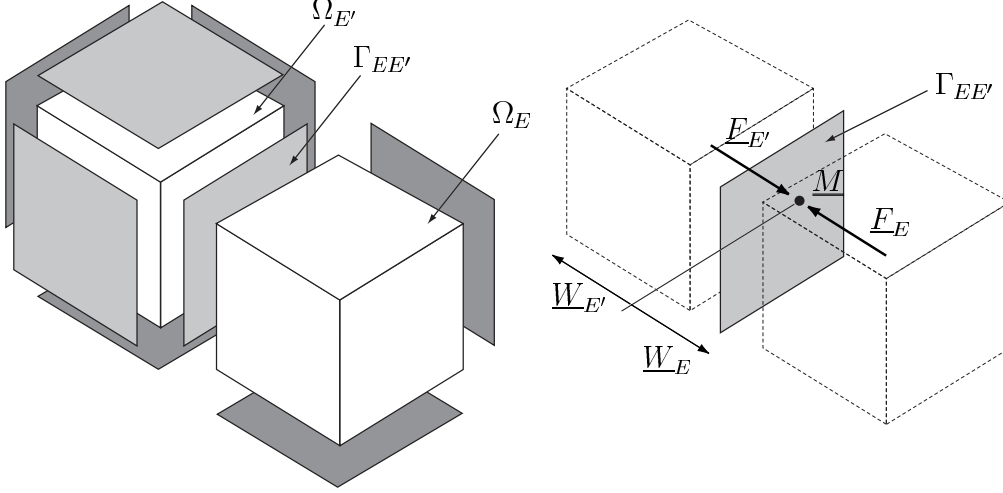

Figure 1: Substructures and interfaces.

are the unknowns, the resulting approach is a “mixed” domain decomposition method, as opposed to the primal substructuring [11, 12] or dual approach [9].

The solution to the reference problem,

$$\mathbf{s} = \bigcup_{E \in \mathbf{E}} \mathbf{s}_E \quad \text{with} \quad \mathbf{s}_E = (\underline{U}_E, \underline{W}_E, \underline{\sigma}_E, \underline{F}_E)$$

with the corresponding space being \mathbf{S} , must satisfy an initial set of equations, \mathbf{A}_d , in order to be admissible, *i.e.*:

- kinematic admissibility equations:

$$\begin{aligned} \underline{U}_E &\in \mathcal{U}_E \\ \underline{\varepsilon}_E &= \underline{\varepsilon}(\underline{U}_E), \quad \underline{U}_E|_{\partial\Omega_E} = \underline{W}_E \end{aligned}$$

- equilibrium equations:

$$\begin{aligned} \underline{\sigma}_E &\in \mathcal{S}_E \\ \forall \underline{U}^* \in \mathcal{U}_E, \quad \int_{\Omega_E} \text{Tr}[\underline{\sigma}_E \underline{\varepsilon}(\underline{U}^*)] d\Omega &= \int_{\Omega_E} \underline{f}_d \cdot \underline{U}^* d\Omega + \int_{\partial\Omega_E} \underline{F}_E \cdot \underline{U}^*|_{\partial\Omega_E} d\Gamma \end{aligned}$$

In addition, s must also satisfy a second set of equations, $\mathbf{\Gamma}$, in order to verify the material and interface behaviors:

- constitutive relation:

$$\underline{\sigma}_E = \mathbf{K}\underline{\varepsilon}_E$$

- interface behavior:

$$\underline{F}_E = -\underline{F}_{E'} = A_{\Gamma_{EE'}}(\underline{W}_E, \underline{W}_{E'})$$

where $A_{\Gamma_{EE'}}$ is the interface behavior operator. For instance, with a perfect interface, the transmission conditions are $\underline{W}_E = \underline{W}_{E'}$; with boundary interfaces, the transmission conditions are the boundary conditions. Various other interface behaviors are conceivable, *e.g.* unilateral contact interface [13].

The regularity required for displacement field \underline{U}_E and stress field $\boldsymbol{\sigma}_E$ is the classical one; for instance, with a three-dimensional analysis, $\mathcal{U}_E = [H^1(\Omega_E)]^3$ and $\mathcal{S}_E = [L^2(\Omega_E)]^6$.

Such a substructuring technique is well-suited to the case of periodic structures [14], but with this approach, boundary areas and interior areas are treated in the same way.

3 DESCRIPTION ON THE MICRO AND MACRO SCALES

3.1 General description

The set of state variables of the structure is expected to possess two parts: one related to the micro-scale, denoted by m , and one related to the macro-scale M , each one with a different characteristic variation length [8].

Here, we define forces and displacements for both scales, on the interfaces. This splitting involves the following quantities: $\underline{F}_{E|\Gamma_{EE'}}$, the restriction to the interface $\Gamma_{EE'}$ of the traction force field \underline{F}_E , and $\underline{W}_{E|\Gamma_{EE'}}$, the restriction to the interface $\Gamma_{EE'}$ of the displacement field \underline{W}_E . Then, on every interface forces and displacements are split into:

$$\begin{aligned}\underline{F}_{E|\Gamma_{EE'}} &= \underline{F}_{E|\Gamma_{EE'}}^M + \underline{F}_{E|\Gamma_{EE'}}^m \\ \underline{W}_{E|\Gamma_{EE'}} &= \underline{W}_{E|\Gamma_{EE'}}^M + \underline{W}_{E|\Gamma_{EE'}}^m\end{aligned}$$

There are two ways to obtain this separation

- First way, the displacement-based strategy: the definition of the macro displacement is given by a projection on the displacement

$$\underline{W}_{E|\Gamma_{EE'}}^M = \mathbf{\Pi}_{\Gamma_{EE'}}^W(\underline{W}_{E|\Gamma_{EE'}})$$

where $\mathbf{\Pi}_{\Gamma_{EE'}}^W$ is a displacement field projector defined on the interface $\Gamma_{EE'}$. Then the corresponding macro part of the forces arises with duality on contribution work:

$$\langle \underline{F}_E, \underline{W}_E \rangle_{\Gamma_{EE'}} = \langle \underline{F}_E^m, \underline{W}_E^m \rangle_{\Gamma_{EE'}} + \langle \underline{F}_E^M, \underline{W}_E^M \rangle_{\Gamma_{EE'}} \quad (1)$$

with

$$\langle \underline{F}_E, \underline{W}_E \rangle_{\Gamma_{EE'}} = \int_{\Gamma_{EE'}} \underline{F}_{E|\Gamma_{EE'}} \cdot \underline{W}_{E|\Gamma_{EE'}} \, d\Gamma$$

- Second way, the traction-based strategy: the definition of the macro traction field is given by a projection on the interface traction force

$$\underline{F}_{E|\Gamma_{EE'}}^M = \mathbf{\Pi}_{\Gamma_{EE'}}^F(\underline{F}_{E|\Gamma_{EE'}})$$

where $\mathbf{\Pi}_{\Gamma_{EE'}}^F$ is a traction field projector defined on the interface $\Gamma_{EE'}$. Then the corresponding macro part of the force arises with duality on contribution work (1).

The first way is related to the initial approach developed in [5, 6]. A subsequent approach which we are developing herein uses the second way. But, for both approaches, the state of the structure is described by micro and macro interface quantities

$$\begin{aligned}(\underline{W}^M, \underline{F}^M) &\in \mathcal{W}_{ad}^M \times \mathcal{F}_{ad}^M \\ (\underline{W}^m, \underline{F}^m) &\in \mathcal{W}^m \times \mathcal{F}^m\end{aligned}$$

It has to be noted that the micro-macro splitting is done at the "continuum medium" level, it involves no discretization.

A major point for both approaches is that micro forces and micro displacements do not have to satisfy transmission conditions across an interface. On the contrary the macro quantities are chosen in order to satisfy these conditions in a weak sense: $(\underline{W}^M, \underline{F}^M) \in \mathcal{W}_{ad}^M \times \mathcal{F}_{ad}^M$. The choice for \mathcal{W}_{ad}^M and \mathcal{F}_{ad}^M depends on the approach used. In the following section, we will discuss an example of a description associated with a traction oriented projector, then \mathcal{W}_{ad}^M and \mathcal{F}_{ad}^M will be specified.

3.2 A traction-based micro-macro description: A continuum mechanics point of view

Let us consider an interface $\Gamma_{EE'}$ between two substructures E and E' . The macro traction force distribution on the interface is obtained from the original force field using a projector $\Pi_{\Gamma_{EE'}}^F$ (chosen as orthogonal with respect to work on $\Gamma_{EE'}$):

$$\underline{F}_{E|\Gamma_{EE'}}^M = \Pi_{\Gamma_{EE'}}^F (\underline{F}_{E|\Gamma_{EE'}})$$

For instance, one can choose to extract the resultant and moment of the field \underline{F}_E on $\Gamma_{EE'}$, as a projector. Then, the micro-level distribution can be deduced:

$$\underline{F}_{E|\Gamma_{EE'}}^m = [\mathbf{Id} - \Pi_{\Gamma_{EE'}}^F] (\underline{F}_{E|\Gamma_{EE'}})$$

and from the duality on the contribution work, the displacement fields can be obtained as follows:

$$\begin{aligned} \underline{W}_{E|\Gamma_{EE'}}^M &= \Pi_{\Gamma_{EE'}}^F (\underline{W}_{E|\Gamma_{EE'}}) \\ \underline{W}_{E|\Gamma_{EE'}}^m &= [\mathbf{Id} - \Pi_{\Gamma_{EE'}}^F] (\underline{W}_{E|\Gamma_{EE'}}) \end{aligned}$$

In this description, \mathcal{F}_{ad}^M is chosen to be the subspace of traction force fields in \mathcal{F}^M which satisfy the transmission conditions on every interface and which are balanced with \underline{f}_d on each substructure. For the displacements, we only have: $\mathcal{W}_{ad}^M = \mathcal{W}^M$, that is to say macro displacement fields do not have to satisfy the transmission conditions between two substructures. Due to that point, this traction-based approach gives priority to the forces whereas in the displacement-based approach, displacements have to be continuous whereas macro traction forces can be discontinuous.

4 COMPUTATIONAL MICRO-MACRO STRATEGY: BASIC ASPECTS

In order to solve the problem related to the assembly of substructures and interfaces, a strategy is developed within the framework of the LATIN Method [7]. For the linear elastic case treated herein, the duality used is a work-based duality and no longer a dissipative one.

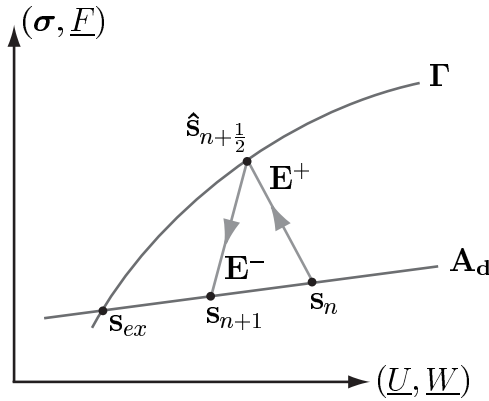

Figure 2: One iteration of the LATIN Method.

The LATIN Method is a non-incremental iterative strategy [7]. It successively builds an element \mathbf{s} of the space of admissible fields \mathbf{A}_d (kinematic and equilibrium equations on each substructure), and an element of the second set Γ (constitutive relation and interface behavior) at each iteration. Iteration n starts with \mathbf{s}_n , an element of \mathbf{A}_d . Then, the local stage is performed from this element to an element $\hat{\mathbf{s}}_{n+\frac{1}{2}}$ of Γ , using the upward search direction \mathbf{E}^+ . Next, the linear stage is performed, leading from $\hat{\mathbf{s}}_{n+\frac{1}{2}}$ to an element \mathbf{s}_{n+1} of \mathbf{A}_d using the downward search direction (see Figure 2). The two search directions represent the parameters of the method.

4.1 Local stage at iteration n

At this stage, the material behavior as well as the interface behavior are satisfied. The problem consists of finding $\hat{\mathbf{s}}_{n+\frac{1}{2}} \in \mathbf{\Gamma}$, given $\mathbf{s}_n \in \mathbf{A}_d$. Moreover, $\hat{\mathbf{s}}_{n+\frac{1}{2}} - \mathbf{s}_n$ has to belong to the upward search direction \mathbf{E}^+ . The upward search direction is given for every substructure E :

$$(\hat{\boldsymbol{\sigma}}_{E,n+\frac{1}{2}} - \boldsymbol{\sigma}_{E,n}) + \mathbf{K}(\hat{\boldsymbol{\varepsilon}}_{E,n+\frac{1}{2}} - \boldsymbol{\varepsilon}_{E,n}) = 0$$

and for every interface $\Gamma_{EE'}$:

$$\begin{aligned} \forall \underline{F}^{m*} \in \mathcal{F}_{EE'}^m \\ \left\langle \frac{1}{k^m} (\hat{\underline{F}}_{E,n+\frac{1}{2}}^m - \underline{F}_{E,n}^m), \underline{F}^{m*} \right\rangle_{\Gamma_{EE'}} - \left\langle \hat{\underline{W}}_{E,n+\frac{1}{2}}^m - \underline{W}_{E,n}^m, \underline{F}^{m*} \right\rangle_{\Gamma_{EE'}} = 0 \end{aligned}$$

as well as:

$$\begin{aligned} \forall \underline{F}^{M*} \in \mathcal{F}_{EE'}^M \\ \left\langle \frac{1}{k^M} (\hat{\underline{F}}_{E,n+\frac{1}{2}}^M - \underline{F}_{E,n}^M), \underline{F}^{M*} \right\rangle_{\Gamma_{EE'}} - \left\langle \hat{\underline{W}}_{E,n+\frac{1}{2}}^M - \underline{W}_{E,n}^M, \underline{F}^{M*} \right\rangle_{\Gamma_{EE'}} = 0 \end{aligned}$$

and similar relations for quantities on $\Gamma_{EE'}$ related to the neighboring substructure $\Omega_{E'}$ of Ω_E .

\mathbf{K} is Hooke's tensor. k^m and k^M are two positive scalar parameters of the method. k^m is related only to micro-quantities and to interface characteristics [8], while the choice for k^M will be discussed later in this paper.

For a perfect interface, $\mathbf{\Gamma}$ contains the transmission conditions for forces:

$$\begin{aligned} \underline{F}_{E'}^m + \underline{F}_E^m &= 0 \\ \underline{F}_{E'}^M + \underline{F}_E^M &= 0 \end{aligned}$$

and for displacements:

$$\begin{aligned} \forall \underline{F}^{m*} \in \mathcal{F}_{EE'}^m, \quad \langle \underline{W}_E^m - \underline{W}_{E'}^m, \underline{F}^{m*} \rangle_{\Gamma_{EE'}} = 0 \\ \forall \underline{F}^{M*} \in \mathcal{F}_{EE'}^M, \quad \langle \underline{W}_E^M - \underline{W}_{E'}^M, \underline{F}^{M*} \rangle_{\Gamma_{EE'}} = 0 \end{aligned}$$

$\mathbf{\Gamma}$ also contains the boundary conditions for boundary interfaces included in $\partial_1\Omega$ or $\partial_2\Omega$.

4.2 Linear stage at iteration n

The problem here consists of finding $\mathbf{s}_{n+1} \in \mathbf{A}_d$, given $\hat{\mathbf{s}}_{n+\frac{1}{2}} \in \mathbf{\Gamma}$. For each substructure E , the stress field has to balance forces on the interfaces:

$$\begin{aligned} \boldsymbol{\sigma}_E \in \mathcal{S}_E, \quad \underline{F}^M \in \mathcal{F}_{ad}^M, \quad \underline{F}^m \in \mathcal{F}^m \\ \forall \underline{U}^* \in \mathcal{U}_E, \\ \int_{\Omega_E} \text{Tr} [\boldsymbol{\sigma}_E \boldsymbol{\varepsilon}(\underline{U}^*)] d\Omega = \int_{\Omega_E} \underline{f}_d \cdot \underline{U}^* d\Omega + \int_{\partial\Omega_E} (\underline{F}_E^M \cdot \underline{U}^*|_{\partial\Omega_E} + \underline{F}_E^m \cdot \underline{U}^*|_{\partial\Omega_E}) d\Gamma \end{aligned}$$

The displacement field has to be compatible with interface displacement fields:

$$\begin{aligned} \underline{U}_E \in \mathcal{U}_E, \quad \underline{W}^M \in \mathcal{W}_{ad}^M = \mathcal{W}^M, \quad \underline{W}^m \in \mathcal{W}^m \\ \underline{U}_E|_{\partial\Omega_E} = (\underline{W}_E^M + \underline{W}_E^m)|_{\partial\Omega_E} \end{aligned}$$

Under the previous conditions, note that we imposed $(\underline{W}^M, \underline{F}^M)$ to belong to $\mathcal{W}_{ad}^M \times \mathcal{F}_{ad}^M$.

The downward search direction \mathbf{E}^- is added to the equations defining \mathbf{s}_{n+1} ; for every substructure, we have:

$$(\boldsymbol{\sigma}_{E,n+1} - \hat{\boldsymbol{\sigma}}_{E,n+\frac{1}{2}}) - \mathbf{K}(\boldsymbol{\varepsilon}_{E,n+1} - \hat{\boldsymbol{\varepsilon}}_{E,n+\frac{1}{2}}) = 0 \quad (2)$$

and for every interface $\Gamma_{EE'}$, we have:

$$\begin{aligned} \forall \underline{F}^{m*} \in \mathcal{F}_{EE'}^m \\ \left\langle \underline{F}_{E,n+1}^m - \hat{\underline{F}}_{E,n+\frac{1}{2}}^m, \underline{F}^{m*} \right\rangle_{\Gamma_{EE'}} + \left\langle k^m (\underline{W}_{E,n+1}^m - \hat{\underline{W}}_{E,n+\frac{1}{2}}^m), \underline{F}^{m*} \right\rangle_{\Gamma_{EE'}} = 0 \end{aligned} \quad (3)$$

and:

$$\begin{aligned} \forall \underline{F}^{M*} \in \mathcal{F}_{ad,0}^M \\ \sum_{\Gamma_{EE'}} \left\langle \frac{1}{k^M} (\underline{F}_{E,n+1}^M - \hat{\underline{F}}_{E,n+\frac{1}{2}}^M), \underline{F}^{M*} \right\rangle_{\Gamma_{EE'}} + \left\langle \underline{W}_{E,n+1}^M - \hat{\underline{W}}_{E,n+\frac{1}{2}}^M, \underline{F}^{M*} \right\rangle_{\Gamma_{EE'}} = 0 \end{aligned} \quad (4)$$

Note that the macro search direction is global due to the choice for \mathcal{F}_{ad}^M in section 3.2.

The resulting problem is then split into two kinds of sub-problems: a global macro problem, and a micro problem on each substructure. In the following discussion, subscripts $n + \frac{1}{2}$ and $n + 1$ will be omitted.

5 A TRACTION-BASED MICRO-MACRO COMPUTATIONAL STRATEGY: A CONTINUUM MECHANICS PRESENTATION

In this section, we will provide details about the problem to be solved at the linear stage (section 4.2). The solution to the local stage problem can be found in [7]. No details will be given here because no specificity has been introduced into the solution of this problem due to the micro-macro splitting.

5.1 Micro-scale problem

Let us consider a substructure E . The stress field $\boldsymbol{\sigma}_E$ is balanced with a boundary field \underline{F}_E and body forces \underline{f}_d . The interface traction force field \underline{F}_E has been split on $\partial\Omega_E$ into micro and macro parts. Due to duality, the displacement field has been split as well. In particular, we have $\underline{W}_{E|\Gamma_{EE'}}^m = [\mathbf{Id} - \boldsymbol{\Pi}_{\Gamma_{EE'}}^F](\underline{W}_{E|\Gamma_{EE'}})$, thus the micro search direction (3) may be written (in the following $\boldsymbol{\Pi}_{\Gamma_{EE'}}^F$ is simply denoted by $\boldsymbol{\Pi}$) as:

$$\begin{aligned} \forall \underline{W}^{m*} \in \mathcal{W}_{EE'}^m \\ \langle \underline{F}_E^m, \underline{W}^{m*} \rangle_{\Gamma_{EE'}} = \langle \hat{\underline{F}}_E^m + k_m \hat{\underline{W}}_E^m - k_m [\mathbf{Id} - \boldsymbol{\Pi}](\underline{U}_{E|\Gamma_{EE'}}), \underline{W}^{m*} \rangle_{\Gamma_{EE'}} \end{aligned}$$

We also take into account the search direction (2) to express the following formulation: find $\underline{U}_E \in \mathcal{U}_E$ such that:

$$\begin{aligned} \forall \underline{U}^* \in \mathcal{U}_E, \\ \int_{\Omega_E} \text{Tr} [\boldsymbol{\varepsilon}(\underline{U}_E) \mathbf{K} \boldsymbol{\varepsilon}(\underline{U}^*)] d\Omega + \int_{\partial\Omega_E} k_m (\mathbf{Id} - \boldsymbol{\Pi}) \underline{U}_{E|\partial\Omega_E} \cdot (\mathbf{Id} - \boldsymbol{\Pi}) \underline{U}^*_{|\partial\Omega_E} = \\ \int_{\Omega_E} \underline{f}_d \cdot \underline{U}^* d\Omega + \int_{\partial\Omega_E} \underline{F}_E^M \cdot \underline{U}^*_{|\partial\Omega_E} d\Gamma + \int_{\partial\Omega_E} (\hat{\underline{F}}_E^m + k_m \hat{\underline{W}}_E^m) \cdot \underline{U}^*_{|\partial\Omega_E} d\Gamma \end{aligned} \quad (5)$$

For the projectors chosen in this paper, resultant and moment are preserved; hence, $k_m (\mathbf{Id} - \boldsymbol{\Pi}) \underline{U}_{E|\partial\Omega_E}$ is a null resultant and moment traction force field, as is $(\hat{\underline{F}}_E^m + k_m \hat{\underline{W}}_E^m)$.

Property 1 *The micro-scale problem admits a solution with an undefined additive rigid body mode displacement field for each substructure if \underline{F}_E^M is balanced with $\underline{f}_{d,E}$.*

Proof. Let us consider a substructure and a traction force field \underline{F}_E leading *a priori* to two different solutions $\underline{U}_E^{(1)}$ and $\underline{U}_E^{(2)}$. With (5) and the particular choice for $\underline{U}^* = \underline{U}_E^{(1)} - \underline{U}_E^{(2)}$, the difference between these two solution fields satisfies:

$$\begin{aligned} \int_{\Omega_E} \text{Tr} \left[\boldsymbol{\varepsilon}(\underline{U}_E^{(1)} - \underline{U}_E^{(2)}) \mathbf{K} \boldsymbol{\varepsilon}(\underline{U}_E^{(1)} - \underline{U}_E^{(2)}) \right] + \\ \int_{\partial\Omega_E} k_m (\mathbf{Id} - \boldsymbol{\Pi})(\underline{U}_E^{(1)} - \underline{U}_E^{(2)}) \cdot (\mathbf{Id} - \boldsymbol{\Pi})(\underline{U}_E^{(1)} - \underline{U}_E^{(2)}) = 0 \end{aligned}$$

Due to the strict positiveness of both \mathbf{K} and k_m and to the choice for $\boldsymbol{\Pi}$, $(\underline{U}_E^{(1)} - \underline{U}_E^{(2)})$ contains the null energy modes for the energy potential, *i.e.* the rigid body modes. One can notice that in the case where $(\underline{U}_E^{(1)} - \underline{U}_E^{(2)})$ is a rigid body mode, $(\mathbf{Id} - \boldsymbol{\Pi})(\underline{U}_E^{(1)} - \underline{U}_E^{(2)}) = 0$ anyway. \square

The condition that \underline{F}_E^M be balanced with \underline{f}_d is fulfilled due to the definition of \mathcal{F}_{ad}^M , according to which \underline{F}_E^M is chosen.

Since the micro-problem defined with (5) is linear, its right-hand side can be separated into a micro-scale contribution ($\underline{f}_d, \hat{\underline{F}}_E^m + k_m \hat{\underline{W}}_E^m$) and a macro-scale contribution \underline{F}_E^M . Therefore, the solution to the micro linear stage problem and in particular its macro-level projection can be written separately on the boundary:

$$\underline{W}_E^M = \mathbf{\Pi} \underline{U}_{E|\partial\Omega_E} = \hat{\underline{U}}_d(\underline{f}_d, \hat{\underline{F}}_E^m + k_m \hat{\underline{W}}_E^m) + \mathbf{L}_E(\underline{F}_E^M) \quad (6)$$

where $\hat{\underline{U}}_d$ is a boundary displacement field to be computed knowing $(\underline{f}_d, \hat{\underline{F}}_E^m + k_m \hat{\underline{W}}_E^m)$. \mathbf{L}_E is an operator that can be interpreted as a homogenized behavior operator of the cell E . \mathbf{L}_E is a finite dimension operator ($6 \times$ number of interfaces, in 3D) defined on $\mathcal{F}_{E,ad}^M$ into \mathcal{W}_E^M ($\mathcal{F}_{E,ad}^M$ is the set of boundary traction force fields balanced with \underline{f}_d on E).

Property 2 The bilinear form $(\underline{F}_E^{M(1)}, \underline{F}_E^{M(2)}) \mapsto \int_{\partial\Omega_E} \mathbf{L}_E(\underline{F}_E^{M(1)}) \cdot \underline{F}_E^{M(2)} d\Gamma$ is symmetric positive definite on $\mathcal{F}_{E,ad,0}^M \times \mathcal{F}_{E,ad,0}^M$.

Proof. Let us consider two macro traction fields $\underline{F}_E^{M(1)}$ and $\underline{F}_E^{M(2)}$ taken in $\mathcal{F}_{E,ad}^M$. Then, the difference $\delta\underline{F}_E^M = \underline{F}_E^{M(1)} - \underline{F}_E^{M(2)}$ belongs to $\mathcal{F}_{E,ad,0}^M$; from equation (5), a displacement field $\delta\underline{U}_E$ can be associated with $\delta\underline{F}_E^M$:

$$\begin{aligned} \forall \underline{U}^* \in \mathcal{U}_E, \int_{\Omega_E} \text{Tr} [\varepsilon(\delta\underline{U}_E) \mathbf{K} \varepsilon(\underline{U}^*)] d\Omega + \\ \int_{\partial\Omega_E} k_m (\mathbf{Id} - \mathbf{\Pi}) \delta\underline{U}_{E|\partial\Omega_E} \cdot (\mathbf{Id} - \mathbf{\Pi}) \underline{U}^*|_{\partial\Omega_E} = \int_{\partial\Omega_E} \delta\underline{F}_E^M \cdot \underline{U}^*|_{\partial\Omega_E} d\Gamma \end{aligned} \quad (7)$$

Using the same formula, we can associate another difference $\Delta\underline{F}_E^M = \underline{F}_E^{M(3)} - \underline{F}_E^{M(4)}$ with another displacement field $\Delta\underline{U}_E$. In the previous equation, we replace \underline{U}^* with $\Delta\underline{U}_E$. Moreover, on the boundary of a substructure, due to the definition of the macro part of the displacement from duality arguments, we obtain:

$$\int_{\partial\Omega_E} \delta\underline{F}_E^M \cdot \Delta\underline{U}_{E|\partial\Omega_E} d\Gamma = \int_{\partial\Omega_E} \delta\underline{F}_E^M \cdot \Delta\underline{W}_E d\Gamma = \int_{\partial\Omega_E} \delta\underline{F}_E^M \cdot \Delta\underline{W}_E^M d\Gamma$$

Recalling that from the definition of \mathbf{L}_E , $\Delta\underline{W}_E^M = \mathbf{L}_E(\delta\underline{F}_E^M)$, we finally obtain:

$$\begin{aligned} \int_{\Omega_E} \text{Tr} [\varepsilon(\delta\underline{U}_E) \mathbf{K} \varepsilon(\Delta\underline{U}_E)] d\Omega + \int_{\partial\Omega_E} k_m (\mathbf{Id} - \mathbf{\Pi}) \delta\underline{U}_{E|\partial\Omega_E} \cdot (\mathbf{Id} - \mathbf{\Pi}) \Delta\underline{U}_{E|\partial\Omega_E} \\ = \int_{\partial\Omega_E} \delta\underline{F}_E^M \cdot \mathbf{L}_E(\Delta\underline{F}_E^M) d\Gamma \end{aligned}$$

for any $(\delta\underline{F}_E^M, \Delta\underline{F}_E^M) \in \mathcal{F}_{E,ad,0}^M \times \mathcal{F}_{E,ad,0}^M$. This allows being conclusive on the positiveness and symmetry of the studied bilinear form.

In order to prove the bilinear form to be definite, let us now assume that $\delta\underline{F}_E^M = \Delta\underline{F}_E^M$ satisfies:

$$\int_{\partial\Omega_E} \delta\underline{F}_E^M \cdot \mathbf{L}_E(\delta\underline{F}_E^M) d\Gamma = 0$$

which immediately leads to the following:

$$\int_{\Omega_E} \text{Tr} [\varepsilon(\delta\underline{U}_E) \mathbf{K} \varepsilon(\delta\underline{U}_E)] d\Omega + \int_{\partial\Omega_E} k_m (\mathbf{Id} - \mathbf{\Pi}) \delta\underline{U}_{E|\partial\Omega_E} \cdot (\mathbf{Id} - \mathbf{\Pi}) \delta\underline{U}_{E|\partial\Omega_E} = 0$$

Thus, $\delta\underline{U}_E$ is a rigid body displacement field of substructure E . From equation (7), we obtain:

$$\begin{aligned} \forall \underline{U}^* \in \mathcal{U}_E, \int_{\partial\Omega_E} \delta\underline{F}_E^M \cdot \underline{U}^*|_{\partial\Omega_E} d\Gamma = 0 \\ \Rightarrow \forall \underline{W}_E^* \in \mathcal{W}_E^M, \int_{\partial\Omega_E} \delta\underline{F}_E^M \cdot \underline{W}_E^* d\Gamma = 0 \\ \Rightarrow \delta\underline{F}_E^M = 0 \end{aligned}$$

This allows us to conclude that the bilinear form is definite. \square

Lastly, \mathbf{L}_E can be computed by solving a small number of micro-scale-like problems (5). The micro-scale problem in (5) can be definitely solved once the macro-forces \underline{F}_E^M are known. This computation is performed within the macro-scale problem.

5.2 Macro-scale problem

The macro-scale problem consists of verifying the macro search direction (4) by taking into account the results obtained at the micro-scale (6): find $\underline{F}^M \in \mathcal{F}_{ad}^M$ such that:

$$\begin{aligned} \forall \underline{F}^{M*} \in \mathcal{F}_{ad,0}^M \\ \sum_{\Gamma_{EE'}} \langle \mathbf{L}_E(\underline{F}_E^M), \underline{F}^{M*} \rangle_{\Gamma_{EE'}} + \left\langle \frac{1}{k_M} \underline{F}_E^M, \underline{F}^{M*} \right\rangle_{\Gamma_{EE'}} = \sum_{\Gamma_{EE'}} \left\langle \frac{\hat{\underline{F}}_E^M}{k_M} + \hat{W}_E^M - \hat{U}_d, \underline{F}^{M*} \right\rangle_{\Gamma_{EE'}} \end{aligned}$$

Property 3 *The macro-scale problem admits a unique solution if $k_M \geq 0$.*

Proof. Property 2 is extended to all interfaces, hence the left-hand side of the macro-scale problem is symmetric and positive definite. The macro-scale problem is a finite dimension problem; consequently, the uniqueness and existence of a solution to this problem is obtained. \square

The macro-traction \underline{F}^M has to be admissible; a typical way of taking into account such a relation is to introduce Lagrange multipliers. In our case, the Lagrange multipliers are the rigid body modes of each substructure; equation (6) thus becomes:

$$\underline{W}_E^M = \mathbf{\Pi} \underline{U}_{-E}|_{\partial\Omega_E} = \hat{U}_d(\underline{f}_d, \hat{\underline{F}}_E^m + k_m \hat{W}_E^m) + \mathbf{L}_E(\underline{F}_E^M) + (\underline{u}_E^{(0)} + \underline{\omega}_E^{(0)} \wedge \underline{OM})|_{\partial\Omega_E}$$

The macro-problem then becomes: find $\underline{F}^M \in \mathcal{F}_{ad}^M$ such that:

$$\begin{aligned} \forall \underline{F}^{M*} \in \mathcal{F}_{ad,0}^M \\ \sum_{\Gamma_{EE'}} \langle \mathbf{L}_E(\underline{F}_E^M), \underline{F}^{M*} \rangle_{\Gamma_{EE'}} + \left\langle \frac{1}{k_M} \underline{F}_E^M, \underline{F}^{M*} \right\rangle_{\Gamma_{EE'}} \\ + \left\langle \frac{1}{k_M} (\underline{u}_E^{(0)} + \underline{\omega}_E^{(0)} \wedge \underline{OM})|_{\partial\Omega_E}, \underline{F}^{M*} \right\rangle_{\Gamma_{EE'}} = \sum_{\Gamma_{EE'}} \left\langle \frac{\hat{\underline{F}}_E^M}{k_M} + \hat{W}_E^M - \hat{U}_d, \underline{F}^{M*} \right\rangle_{\Gamma_{EE'}} \end{aligned} \quad (8)$$

which is statically admissible:

$$\begin{aligned} \forall (\underline{u}_E^{(0)*} + \underline{\omega}_E^{(0)*} \wedge \underline{OM}) \\ \int_{\Omega_E} \underline{f}_d \cdot (\underline{u}_E^{(0)*} + \underline{\omega}_E^{(0)*} \wedge \underline{OM}) \, d\Omega + \int_{\partial\Omega_E} \underline{F}_E^M \cdot (\underline{u}_E^{(0)*} + \underline{\omega}_E^{(0)*} \wedge \underline{OM}) \, d\Gamma = 0 \end{aligned} \quad (9)$$

The solution to the macro problem (8,9) (which does not depend on the micro unknowns, once \hat{U}_d has been calculated up to the micro-scale) leads to the macro force field \underline{F}^M at iteration n , as well as to additive rigid body modes. The micro-scale problem can then be completed to obtain the micro contributions at iteration n .

5.3 Convergence

Following the convergence proof for the one-level strategy given in [7], with standard assumptions for elasticity, convergence is reached if the search directions are framed by two constants k_1 and k_2 , such that:

$$\begin{aligned} \infty > k_2 \geq k_m \geq k_1 > 0 \\ \infty \geq k_M \geq 0 \end{aligned}$$

In particular, if \mathbf{s}_{ex} denotes the solution to the reference problem (*i.e.* the intersection between \mathbf{A}_d and $\mathbf{\Gamma}$ on Figure 2), we have:

$$\lim_{n \rightarrow \infty} \|\mathbf{s}_n - \mathbf{s}_{ex}\| = 0 \quad \text{and} \quad \lim_{n \rightarrow \infty} \|\hat{\mathbf{s}}_{n+\frac{1}{2}} - \mathbf{s}_{ex}\| = 0$$

with:

$$\begin{aligned} \|\mathbf{s}\|^2 &= \sum_E \int_{\Omega_E} \text{Tr} [\boldsymbol{\sigma}_E \mathbf{K}^{-1} \boldsymbol{\sigma}_E + \boldsymbol{\varepsilon}_E \mathbf{K} \boldsymbol{\varepsilon}_E] d\Omega \\ &+ \sum_{\Gamma_{EE'}} \int_{\Gamma_{EE'}} (\underline{F}_E^m \cdot \frac{1}{k_m} \underline{F}_E^m + \underline{W}_E^m \cdot k_m \underline{W}_E^m + \underline{F}_E^M \cdot \frac{1}{k_M} \underline{F}_E^M + \underline{W}_E^M \cdot k_M \underline{W}_E^M) d\Gamma \end{aligned}$$

6 OPTIMIZATION OF THE ALGORITHM PARAMETERS

From a continuum mechanics point of view, two scalar parameters appear in the traction-based strategy: the search direction parameters. The micro-level parameter k_m appears in equation (3) and the macro-level parameter k_M in equation (4). In all examples treated herein, the macro part of interface traction fields consists of the linear part of these fields.

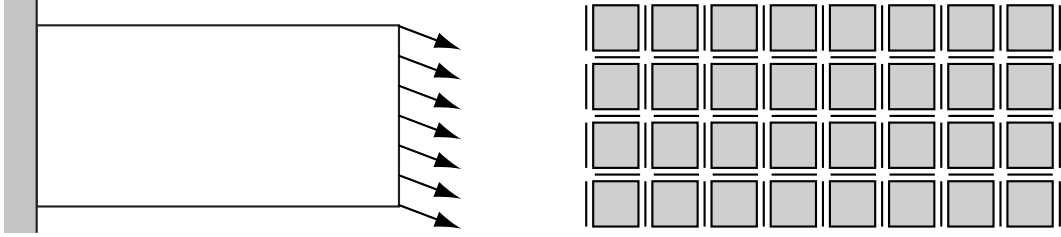

Figure 3: Cantilever structure clamped to one end and submitted to a flexion-tension loading at the other end.

The first test example proposed is a cantilever structure. It is solved in 2D under a plane strain assumption. The structure is clamped at one extremity and submitted to a non-axial force distribution at the other extremity. The structure under study has been split into 32 substructures (see Figure 3). Each substructure has been discretized with 512 3-node triangular finite elements. The influences of both discretization and substructuring are not discussed in this paper. For the sake of simplicity, in order to focus on the numerical parameters' optimal values, the material constituting the structure is linear elastic, homogeneous and isotropic.

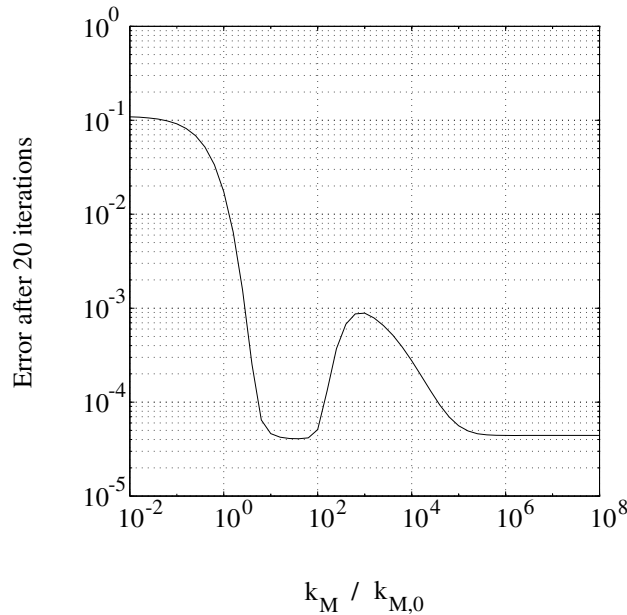

Figure 4: Traction-based micro-macro LATIN strategy: Error after 20 iterations.

Iterative solutions were computed using the traction-based strategy. For each element of a test-value sample for k_M , we performed 20 iterations of the method. k_m remains constant and equal to $E/25L_m$,

with L_m being the characteristic length of a substructure. The direct solution of the finite element problem was taken as a reference. The error relative to this reference solution was compared versus the value of $k_M/k_{M,0}$ in Figure 4. This error has been measured with a global energy norm on the displacement difference between the two solutions. (The starting value $k_{M,0}$ is classically related to the whole structure's characteristic dimension [8]: $k_{M,0} = E/L_M$, where E is the Young's modulus of the material and L_M is the length of the structure.)

An optimal value for k_M then appears (see Figure 4):

$$k_M \rightarrow \infty$$

The macro-problem can thus be rewritten taking this result into account.

Concerning the displacement-based approach described in [6], a similar result is obtained. Performing the same test as previously discussed, and considering the linear part of interface displacement as macro-displacement, the resulting chart is shown in Figure 5. Using this strategy, the optimal value is found:

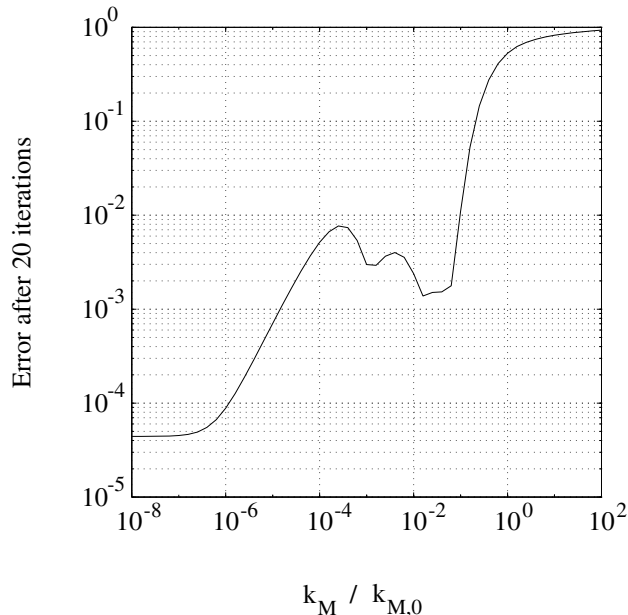

Figure 5: Displacement-based micro-macro LATIN strategy: Error after 20 iterations.

$k_M = 0$. The macro-scale problem therefore has to be rewritten as well.

Remarkable result. One can note that the previous two optimal versions coincide (as soon as the macro projectors for the displacement-based approach and for the traction-based approach are conjugate). In particular, in this unified approach both macro-displacements and macro-forces verify the transmission conditions at any iteration, not only when convergence is reached. The major point lies in the fact that a parameter has been deleted: *only k_m remains*. This last parameter is related to the characteristic dimensions of a substructure. A first evaluation of k_m has already been proposed in [8].

7 AN EXAMPLE OF HIGHLY-HETEROGENEOUS STRUCTURAL CALCULATIONS

The iterative strategy proposed herein has been specially created to treat heterogeneous structures with optimal efficiency. This approach can be used to analyze composite structures, by taking directly into account the microstructure of the considered material. The unified version is of course used here.

In order to demonstrate the possibilities of this method, we will present some examples of finite element calculation. These examples are performed in 2D under the assumption of plane strains. The material is heterogeneous, yet every component displays an elastic isotropic behavior. Two elementary cells are proposed: (A) a fiber-reinforced composite, and (B) honeycomb (see Figure 6). For these two heterogeneous material cells, the heterogeneity ratio is 10^3 : for cell (A), the fiber inclusions are 10^3

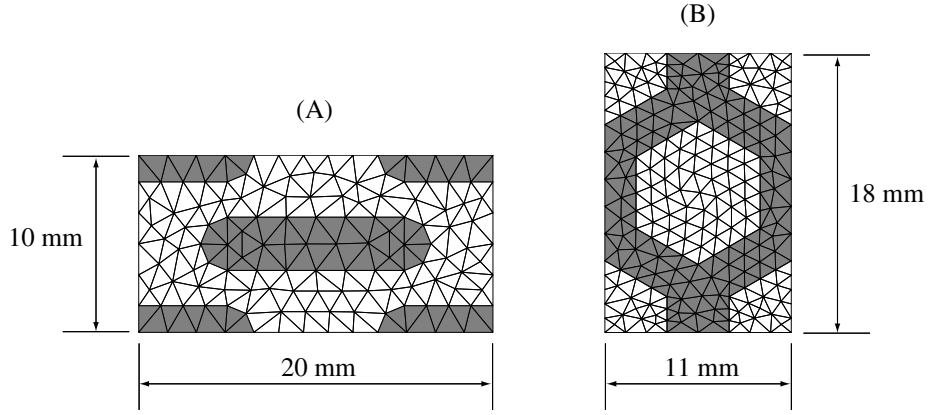

Figure 6: (A) fiber-reinforced composite cell; (B) honeycomb cell.

times stiffer than the matrix; for cell (B), the honeycomb structural parts are 10^3 times stiffer than the material in the cavities. The Young's modulus is taken as equal to 2.10^5 MPa, and the Poisson's ratio 0.3.

This strategy has been tested on cantilever structures containing various numbers of elementary cells (A) and (B) (see Figure 7). The whole structure is decomposed into as many substructures as elementary cells: hence, each substructure is constituted of 1 elementary cell. The cantilever structures are clamped at one end and submitted to a flexion-shear force distribution at the other end. These structures are under a global flexion loading. Figure 7 shows the configurations of these different structures for the two proposed cell types.

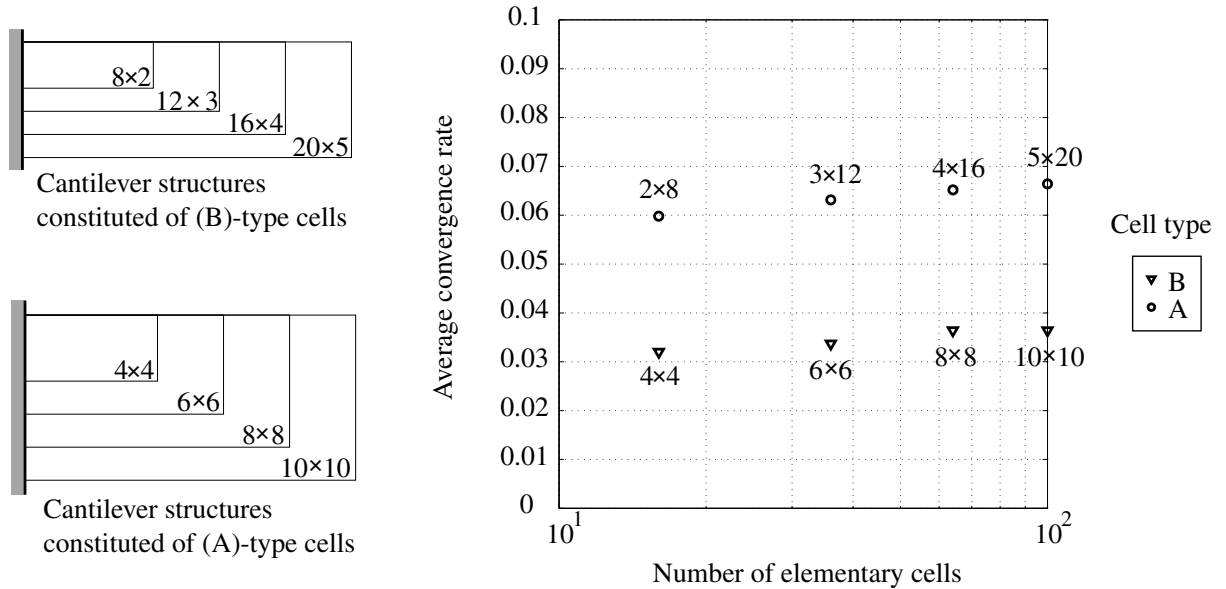

Figure 7: Average convergence rate after 30 iterations: (1) for the two cells proposed, (A) fiber-reinforced composite and (B) honeycomb; and (2) for different numbers of substructures: 16, 36, 64 and 100.

Concerning the calculation results, we have reported the average convergence rate after 30 iterations of the method for different numbers of elementary cells in Figure 7 and Table 1. This average convergence rate is computed using the following formula:

$$\tau_{avg} = -\frac{1}{29} \log\left(\frac{e_{30}}{e_1}\right)$$

Table 1: Average convergence rate after 30 iterations.

Number of substructures	16	36	64	100
(A)	$6.0 \cdot 10^{-2}$	$6.3 \cdot 10^{-2}$	$6.5 \cdot 10^{-2}$	$6.6 \cdot 10^{-2}$
(B)	$3.2 \cdot 10^{-2}$	$3.4 \cdot 10^{-2}$	$3.6 \cdot 10^{-2}$	$3.6 \cdot 10^{-2}$

where e_{30} and e_1 represent the energy norm of the error between the iteratively-calculated solution and the reference solution (result of the direct finite element problem) after 30 iterations and after the first iteration, respectively. This value remains constant for the 4 tests performed on both cell types. As a consequence, due to the optimal choice for the parameter k_M in the previous section, the method seems to be numerically scalable *i.e.* independent of the number of substructures. The convergence result is only dependent only on the complexity of the local substructure problem.

In Figure 8, is reported the energy norm of the error between the iterative solution and the reference solution (result of the direct finite element problem without substructuring) for the problem of 64 substructures of (A)-type cells, for which the proposed approach yields the best results. 30 iterations have been performed. As a reference, we have also performed 30 iterations of the original FETI Method for two different preconditioners [9] (without heterogeneous improved scaling [15]). It should be pointed out that no preconditioner has been used in the LATIN micro-macro approach.

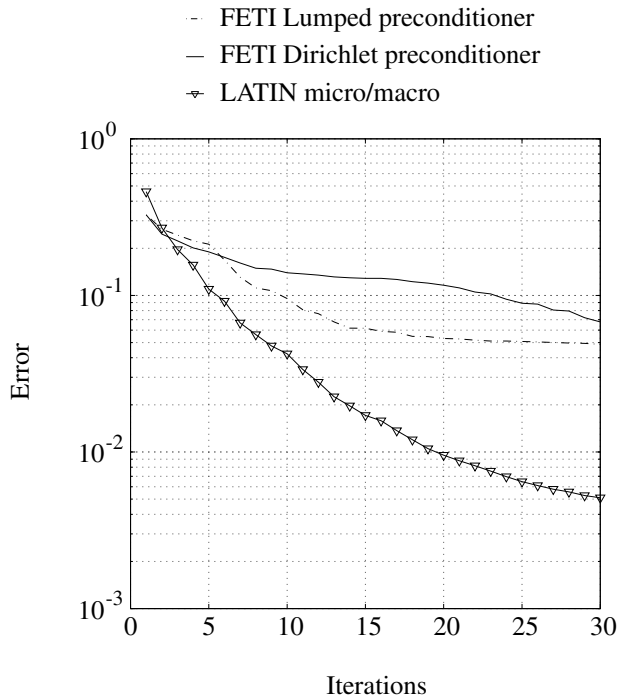

Figure 8: Evolution of the error for 30 iterations of the method applied to the problem of 64 (A)-type cells.

In order to obtain information on the costs of the different approaches, the major trends can be estimated by the complexity analysis of the algorithms. We have used a band storage, Crout factorization as a linear solver and an arrow pattern of rigidity matrices with Schur condensation for the micro-macro approach. For the previous example, the initialization stage (initial factorizations and condensation for all the substructures and for the macro problems) leads to the following results: (a) the FETI Method with a Dirichlet preconditioner cost is 40% that of the LATIN micro-macro approach, and (b) the FETI Method with a lumped preconditioner cost is 20% that of the LATIN micro-macro approach. Concerning one single iteration (dot products, forward and back substitution, also cumulated on all substructures), the costs are: (a) the FETI Method with a Dirichlet preconditioner is equivalent to the LATIN micro-macro approach, and (b) the FETI Method with a lumped preconditioner is half of the previous cost. These results have been obtained on a small 2D problem. Because the global problem in a LATIN micro-macro approach is always large when compared to the corresponding problem in FETI, the same

estimations tend to position the micro-macro close to the FETI lumped complexity, as the size of the local problems increases. Concerning the synchronization between processes, the FETI method needs to solve 2 global problems at each iteration and thus to synchronize twice all the processors with one of them. The micro-macro approach as previously described, requires only 1 such synchronization per iteration.

In Figures 9 and 10, we present the calculated solutions after the 1st and 28th iterations. The information given by the macro and micro scales on the interfaces have also been indicated. One substructure on the first left-hand column of substructures is magnified in order to focus on the macro and micro projections of the interface displacements.

As a conclusion, we can say, roughly speaking, that the cost of a micro-macro iteration is similar to the cost of a FETI iteration. Moreover, the cost of preliminary calculations becomes similar for both methods, as the problem size increases. As a consequence, if the convergence rate observed on the last example is preserved, the micro-macro computational strategy can be much more efficient for highly heterogeneous structure calculations. However, for weakly heterogeneous structures, the cost should be the same, as observed in [8].

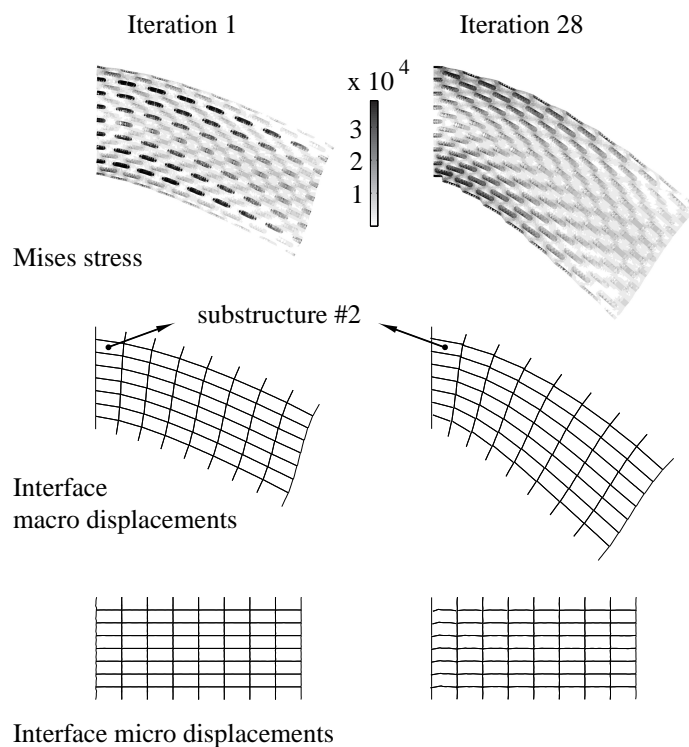

Figure 9: Representation of the solution calculated after the 1st and 28th iterations.

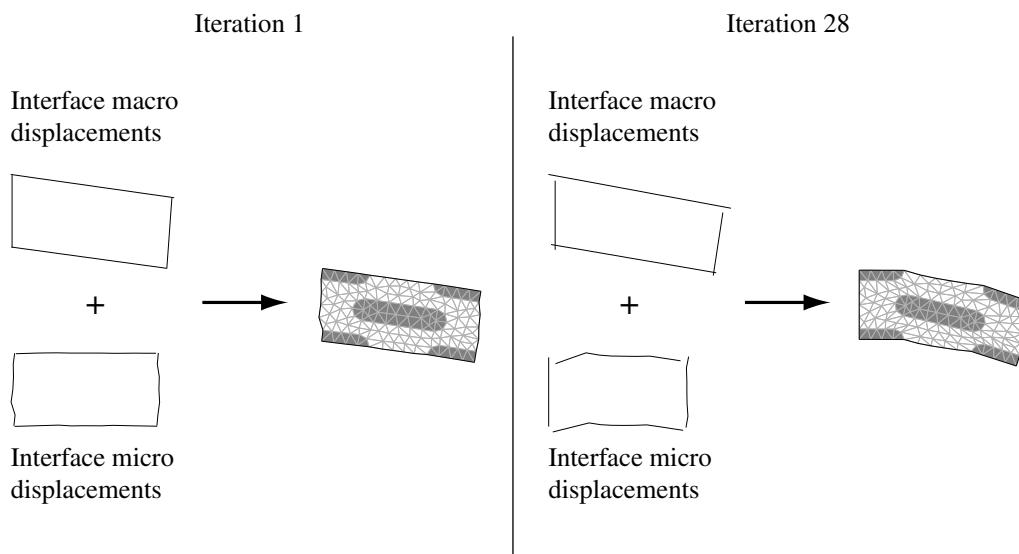

Figure 10: Displacement solution after the 1st and 28th iterations. Contributions of the macro and micro scales to the interface displacements for substructure #2.

8 CONCLUSION

Both the optimal displacement-based and traction-based micro-macro strategies form a unique strategy characterized by only one parameter, interpreted as a micro-stiffness.

Moreover, this approach leads to a parallel and mechanical approach, which is related to domain decomposition methods and well-suited to parallel architecture computers; the underlying algorithm can be interpreted as a “mixed” and 2-level domain decomposition method. It leads to a numerically-scalable and efficient domain decomposition method.

In certain cases, using 3 scales could be of interest from a modelling point of view and/or for a computational efficiency issue. For instance laminate composite structures usually involve a micro scale (fiber, matrix level), a meso scale (ply and interface level), a macro scale (the whole structure level). Hence we can imagine a 3-level approach involving 2 homogenization procedures close to the one proposed in this paper. Another way to introduce a third scale is to use a discretization on the macro scale. In that case, a patch of cells is replaced by a super-element in order to reduce the computational cost of the macro problem. This last approach is currently under testing.

Further work is also in progress to extend this computational strategy to contact problems as well as to plasticity and visco-plasticity problems.

References

- [1] E. Sanchez-Palencia. Non homogeneous media and vibration theory. *Lectures Notes in Physics*, 127, 1980.
- [2] J. Fish, V. Belsky. Multigrid method for periodic heterogeneous media (part 1,2). *Computer Methods in Applied Mechanics and Engineering*, 32:1–38, 1995.
- [3] J.T. Oden, K. Vemaganti, N. Moës. Hierarchical modelling of heterogeneous solids. to appear in a special issue *Computational Advances in Modelling Composites and Heterogeneous Materials*.
- [4] J.T. Oden, T.I. Zohdi. Analysis and adaptive modelling of highly heterogeneous structures. *Computer Methods in Applied Mechanics and Engineering*, 148:367–392, 1997.
- [5] P. Ladevèze, D. Dureisseix. A new micro-macro computational strategy for structural analysis. *Comptes-Rendus de l'Académie des Sciences*, 327:1237–1244, 1999. (partially in english).
- [6] P. Ladevèze, D. Dureisseix. A micro-macro approach for parallel computing of heterogeneous structures. to appear in *Journal of Computational Civil and Structural Engineering*.
- [7] P. Ladevèze. *Nonlinear Computational Structural Mechanics - New Approaches and Non-Incremental Methods of Calculation*. Springer Verlag, 1999.
- [8] D. Dureisseix, P. Ladevèze. A multi-level and mixed domain decomposition approach for structural analysis. In *Domain Decomposition Methods 10*, pages 246–253. Contemporary Mathematics, 1998.
- [9] C. Farhat, F.-X. Roux. A method of finite element tearing and interconnecting and its parallel solution algorithm. *International Journal for Numerical Methods in Engineering*, 32:1205–1227, 1991.
- [10] P. Ladevèze, D. Dureisseix. Une nouvelle stratégie de calcul parallèle et micro/macro en mécanique non-linéaire. Technical Report 188, Laboratoire de Mécanique et Technologie, Cachan, 1997.
- [11] J. Mandel. Balancing domain decomposition. *Communications in Applied Numerical Methods*, 9:233–241, 1993.
- [12] P. Le Tallec. Domain decomposition methods in computational mechanics. *Computational Mechanics Advances*, 1, 1994.
- [13] L. Champaney, J.-Y. Cognard, D. Dureisseix, and P. Ladevèze. Large scale applications on parallel computers of a mixed domain decomposition method. *Computational Mechanics*, (19):253–263, 1997.
- [14] A. El Hami, B. Radi. Some decomposition methods in the analysis of repetitive structures. *Computers and Structures*, 58(5):973–980, 1996.

- [15] D. Rixen and C. Farhat. A simple and efficient extension of a class of substructure based preconditioners to heterogeneous structural mechanics problems. *International Journal for Numerical Methods in Engineering*, 46:501–534, 1998.