



HAL
open science

Simulation of the long-term carbon and nitrogen dynamics in Dutch forest soils under Scots pine

B.-J. Groenenberg, W. de Vries, H. Kros

► **To cite this version:**

B.-J. Groenenberg, W. de Vries, H. Kros. Simulation of the long-term carbon and nitrogen dynamics in Dutch forest soils under Scots pine. *Hydrology and Earth System Sciences Discussions*, 1998, 2 (4), pp.439-449. hal-00304568

HAL Id: hal-00304568

<https://hal.science/hal-00304568>

Submitted on 18 Jun 2008

HAL is a multi-disciplinary open access archive for the deposit and dissemination of scientific research documents, whether they are published or not. The documents may come from teaching and research institutions in France or abroad, or from public or private research centers.

L'archive ouverte pluridisciplinaire **HAL**, est destinée au dépôt et à la diffusion de documents scientifiques de niveau recherche, publiés ou non, émanant des établissements d'enseignement et de recherche français ou étrangers, des laboratoires publics ou privés.

Simulation of the long-term carbon and nitrogen dynamics in Dutch forest soils under Scots pine

Bert-Jan Groenenberg, Wim de Vries and Hans Kros

DLO-Winand Staring Centre for Integrated Land, Soil and Water Research, P.O. Box 125, 6700 AC Wageningen, Netherlands.

Abstract

Dynamics of C and N in forest soils in the Nutrient Cycling and Soil Acidification Model (NUCSAM) are described by the transformation and decomposition of three organic matter compartments, litter, fermented material and humic material. These three compartments are allocated to the morphological distinguishable L, F and H horizons of the organic layer. Changes in the pools of these organic compartments are described with first order equations for decomposition and transformation. Rate constants for decomposition and transformation were derived by calibrating the model to measured organic matter pools in organic layers of a chronosequence of five first succession Scots pine stands between 15 and 120 years old.

Simulated pools of organic matter in the organic layers were in agreement with measured pools in the five pine stands, except for the first thirty years of the H-horizon. During this period, an increase in organic matter in the H horizon was simulated while no H horizons were observed in the field. The simulated total pool of organic matter in the organic layer agreed well with values from a field inventory in 20 other Scots pine stands, but the simulated distribution over the three horizons differed from the field measurements which varied among sites. For the Scots pine stands the model was able to simulate the organic matter accumulation in the top 40-cm of the mineral soil; derived almost completely from fine root turnover. The accumulated pool of nitrogen in the organic layer was in agreement with measured pools for the oldest Scots pine stand but was too high for the younger stands. Especially, the accumulation of N in the F-horizon was too fast, presumably due to an overestimated retention of nitrogen.

Introduction

Carbon (C) dynamics in forest ecosystems are of interest in the perspective of global change, soil acidification and eutrophication by nitrogen. Furthermore, the production of dissolved organic carbon (DOC), which may mobilise heavy metals such as Cu and Pb, is strongly related to the mineralisation of organic matter. Elevated levels of nitrogen (N) deposition may cause ecosystems to become N 'saturated' (e.g. Ågren and Bossata, 1988 and Aber *et al.*, 1989). 'Saturation' occurs when the input of N together with the mineralisation or fixation exceeds the uptake requirements of the vegetation. This will lead to leaching losses of inorganic N in streamflow or groundwater discharge. Leaching of the strong acid anion nitrate (NO_3) also causes soil acidification. Leaching to surface waters may increase levels of N and hence lead to eutrophication. Leaching of N to groundwater is a potential threat to human health if this water is to be used as drinking water. In the Netherlands, high concentrations of NO_3 often occur especially in areas with intensive animal husbandry. Concentrations in shallow groundwater underneath forests range between 0 and 200 mg l^{-1} NO_3 (Boumans and Beltman, 1991), often exceeding the EC drinking water

standard of 50 mg l^{-1} NO_3 . Mathematical models of C and N dynamics are indispensable tools both for a better scientific understanding of the dynamics of these elements and for development of scientifically based emission abatement policies for N.

Repeated soil inventories of C (organic matter) and N pools over a period of several decades have shown that the N dynamics of forest soils is determined mainly by changes in the organic pool (e.g. Bredemeier *et al.*, 1995 for the Solling spruce site in Germany; Van Breemen *et al.*, 1988 for the Hackfort site in the Netherlands). The dominant influence of the organic layer on C and N dynamics in Dutch forest soils has also been illustrated by input-output budgets and mineralisation experiments (Tietema, 1992). The importance of the organic layer on N dynamics is further illustrated by the empirical relationship between NO_3 leaching in forest ecosystems and organic layer C/N ratios (Gundersen *et al.*, 1998). On long time scales, soil organic matter is also expected to be important for C and N dynamics because C and N pools in mineral soils, in general, exceed those in the organic layer.

The aim was to design a simple model, able to simulate C and N dynamics from short to long time scales.

Therefore (i) it should account for differences in mineralisation rates of organic matter compartments with a different degree of decomposition, and (ii) should be able to simulate the changing pools of N in each organic matter compartment. A second requirement was that it should be possible to calibrate C and N pools for all organic matter compartments distinguished on field measurements. Several models, such as SOM (Jenkinson and Rayner, 1977); CENTURY (Parton *et al.*, 1987); NICCE (Van Dam and Van Breemen, 1995) and MERLIN (Cosby *et al.*, 1997), distinguish two or more organic matter compartments with different decay rates. The SOM and Century models distinguish five organic matter compartments and the MERLIN model two compartments. A commonality of the models is that the organic matter compartments distinguished are conceptual, i.e. they cannot be separated chemically or physically. A drawback of the use of such conceptually defined organic compartments is that pools of organic matter and N in the compartments distinguished are not separately measurable, although some progress has been made to relate particle size fractions in organic matter to different compartments (Balesdent, 1996). It is, therefore, not possible to calibrate these models on measured pools of organic matter and N in their corresponding organic matter compartments. Therefore, organic matter was divided from the organic layer and mineral soil over three organic matter compartments i.e. litter, fermented material and humified material. For the organic layer, the three organic matter compartments were allocated to the morphologically distinguishable L, F and H horizons. This makes it possible to calibrate and validate the model directly on measured pools in the L, F and H horizons of the organic layer.

To be able to simulate changes in N contents for the compartments distinguished, the N contents for the different compartments were modelled dynamically and fixed C/N ratios for the different compartments were not used, as in some other models (e.g. CENTURY, Parton *et al.*, 1987). Whereas the three organic matter compartments were chosen here on an empirical basis because of the requirement that the model should be calibrated on these compartments, Chertov and Komarov (1997) developed a model for soil organic matter dynamics (SOMM) with the same three organic matter compartments. They based their compartments, however, on the role of different decomposers (i.e. fungi, bacteria, micro- and meso- fauna) in the different decomposition stadia of organic matter.

This paper describes a model for C and N dynamics, which is a submodel of the Nutrient Cycling and Soil Acidification Model (NUCSAM). NUCSAM (Groenenberg *et al.*, 1995; Kros *et al.*, 1996) is an integrated soil acidification model, which simulates the major hydrological and biogeochemical processes in the forest canopy, organic layer and mineral soil. The model accounts for tree growth (forcing functions for stem and branches, roots and leaves), litter fall, root death, canopy interactions, miner-

alisation, nitrification, denitrification, hydrological processes, solute transport, adsorption of sulphur (S) and phosphorus (P), weathering of aluminium (Al) and base cations, cation exchange and complexation reactions in soil solution. Earlier publications regarding NUCSAM were focussed on the application of the model on intensively monitored sites (Groenenberg *et al.*, 1995; Tiktak *et al.*, 1997) and most emphasis was given to changes in the soil solution chemistry. A brief description of the organic matter dynamics within NUCSAM is given in Kros *et al.* (1996) and Tiktak *et al.* (1997). This is the first complete description of the submodel for C and N dynamics in NUCSAM.

The main aim of this study was to test whether this submodel was able to simulate changes of organic matter and N in the L, F and H horizons of the organic layer in time by comparing simulated and measured pools in a chronosequence of Scots pine stands in the Netherlands. Furthermore, it tested whether the model concept for organic matter dynamics could also be used to simulate the change of organic matter in the mineral top soil.

Description of carbon and nitrogen dynamics in NUCSAM

GENERAL APPROACH

To describe the accumulation and decay of organic matter, a concept with more than one organic matter compartment was chosen. Models with only one compartment are not able to describe the long-term dynamics of mineralisation because the apparent decay constant changes with time. In NUCSAM, organic matter is divided over three compartments i.e. a litter compartment (fresh organic matter), a compartment with fermented material and a humus compartment. Litter, fermented material and humic material were assigned to three morphologically distinguishable compartments i.e. the L, F and H horizons of the organic layer. These morphologically distinguishable compartments can be sampled in the field separately to measure pools of organic matter and contents of nutrients. The compartments represent successive stadia in the decomposition of organic matter, of which the litter compartment is the most easily decomposable compartment and humus, the most refractory compartment. Besides litter input from above ground material, the F and H horizon also derive organic matter by the turnover of fine roots. Decomposition of roots is described analogous to the decomposition of above ground litter. Fig. 1 gives a schematic presentation of the organic matter pathways in NUCSAM. Fresh organic material (leaf fall and root death) is added to the litter compartment. Material from the litter compartment is mineralised to carbon dioxide CO₂ and DOC (mi_l) and transformed into fermented material (tr_l). Fermented material is mineralised to CO₂

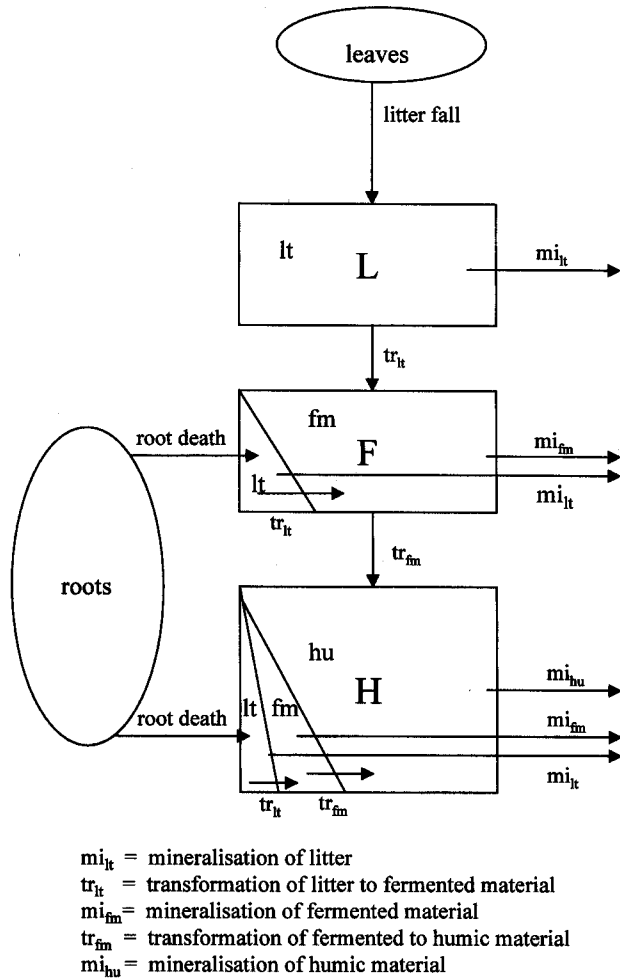

Fig. 1. Schematic presentation of organic matter model within NUCSAM. L, F and H denote the organic horizons, lt is litter, fm is fermented material and hu is humic material.

and DOC (mi_{fm}) and transformed into humic material (tr_{fm}). Humic material is the final stadium of organic matter decay and therefore is only mineralised (mi_{hu}). Part of the humic material from the organic layer may be translocated to the mineral soil as a result of bio-turbation. Organic matter in living biomass is lumped with dead organic material because living biomass is only a small fraction of organic matter in soils.

MASS BALANCES OF CARBON

Mass balances of C in the various organic compartments are determined by the input to the compartment either by addition of fresh organic material (litter compartment) or by transformation of organic matter (fermented and humus compartment) and by the output due to mineralisation and further transformation (see Fig. 1). Mineralisation and transformation of the organic carbon compartments are modelled as first order processes. For the litter compartment, the mass balance thus equals:

$$\frac{dC_{lt}}{dt} - (F_{in,om}(t) - (k_{mi,lt} + k_{tr,lt})Am_{lt}(t)) \cdot ctC_{om} \quad (1)$$

with: C_{lt} the amount of organic C in litter (kg m^{-2}); Am_{lt} is the amount of organic matter in the litter fraction (kg m^{-2}); $F_{in,om}(t)$ is the input flux of fresh organic material (leaf fall and root death) ($\text{kg m}^{-2} \text{a}^{-1}$); $k_{mi,lt}$ is the mineralisation rate of the litter compartment (a^{-1}); $k_{tr,lt}$ is the transformation rate of litter to fermented material (a^{-1}) and ctC_{om} the C content in organic matter ($\text{kg}^{-1} \text{kg}^{-1}$). In the model, the C content of organic matter does not change with ongoing decomposition, i.e. $ctC_{om} = ctC_{lt} = ctC_{fm} = ctC_{hu}$, according to the similar C content found in bulked samples of the L and F horizons compared to H horizons as determined in a field inventory of 150 forest stands (De Vries and Leeters, 1998). The input flux of fresh organic material (root death and leaf fall) depends on the amount of leaves and roots according to:

$$F_{in,om}(t) = kr_{lf} \cdot Am_{lv}(t) + kr_{rd} \cdot Am_{rt}(t) \quad (2)$$

where kr_{lf} and kr_{rd} are respectively the rate constants for leaf fall and root death and $Am_{lv}(t)$ and $Am_{rt}(t)$ are the amounts of leaves and roots (kg m^{-2}): the latter increase in time according to an exponential function to a maximum:

$$Am_{lv}(t) = (1 - e^{-k_{gr,lv}t}) Am_{lv,max} \quad (3a)$$

$$Am_{rt}(t) = (1 - e^{-k_{gr,rt}t}) Am_{rt,max} \quad (3b)$$

with: $Am_{lv/rt,max}$ the maximum amount of leaves/roots (kg m^{-2}); $k_{gr,lv}$ and $k_{gr,rt}$ the exponential leaf and root growth constants respectively (a^{-1}) and t the tree age in years.

For fermented and humus material the mass balances equal:

$$\frac{dC_{fm}}{dt} - (k_{tr,lt}Am_{lt}(t) - (k_{mi,fm} + k_{tr,fm})Am_{fm}(t)) \cdot ctC_{om} \quad (4)$$

and

$$\frac{dC_{hu}}{dt} - (k_{tr,fm}Am_{fm}(t) - (k_{mi,hu}Am_{hu}(t))) \cdot ctC_{om} \quad (5)$$

with: Am_{fm} the pool of organic material in the fermented compartment (kg m^{-2}); Am_{hu} the pool of organic material in the humus compartment; $k_{mi,fm}$ the mineralisation rate of the fermented compartment (a^{-1}); $k_{tr,fm}$ the transformation rate of fermented to humic material (a^{-1}) and $k_{mi,hu}$ the mineralisation rate of the humic compartment (a^{-1}). Part of the organic matter from the humus compartment may be translocated to the mineral soil by bio-turbation. Bio-turbation is modelled with a constant fraction of newly formed humus transferred to the mineral soil.

Mineralisation and transformation rates depend on temperature and moisture content. In NUCSAM, rate constants are corrected for temperature and moisture effects by multiplying the rate constants with correction factors.

MASS BALANCES FOR NITROGEN

Similar to the balances for organic C, for each compartment N balances can be defined according to:

$$\frac{dN}{dt} - FN_{in}(t) - FN_{out}(t) \quad (6)$$

Where FN_{in} is the flux of N entering an organic matter compartment and FN_{out} is the flux of N leaving the compartment. Input fluxes are coupled directly to the input fluxes of organic matter by:

$$FN_{in} = C/N_{in} \cdot FC_{in} \quad (7)$$

Where C/N_{in} is the C/N ratio of the incoming organic material and FC_{in} is the influx of C by leaf fall, root death or transformation of the litter or fermented compartment. Mineralisation of N in each organic matter compartment was coupled with C mineralisation. At low N contents, the rate of N mineralisation is reduced to account for N immobilisation (Janssen, 1984; de Vries *et al.*, 1994) according to:

$$fN_{mi} = 1 + \frac{1}{RDA_{mo}} \cdot \left(\frac{C/N_{mo} - C/N_s}{C/N_{mo}} \right) \quad (8)$$

for $C/N_{mo} < C/N_s(1 + RDA_{mo}) \cdot C/N_{mo}$

where fN_{mi} is the reduction factor by which the mineralisation constants are multiplied, C/N_{mo} is the C/N ratio of the micro-organisms decomposing the substrate, C/N_s is the C/N ratio of the substrate (litter compartment, fermented compartment and humus compartment), fermented material and humic material) and RDA_{mo} is the dissimilation to assimilation ratio of the decomposing microbes. The outgoing flux of each compartment by mineralisation thus equals:

$$FN_{mi} = F_{mi,om} \cdot ctN_{om} \cdot fN_{mi} \quad (9)$$

Where FN_{mi} is the flux of N from mineralisation of organic matter from the litter, fermented or humus compartment and $F_{mi,om}$ is the mineralisation flux of organic matter from the litter, fermented or humus compartment. N contents in the different compartments are, thus, determined by the N content of the incoming organic material, the dissimilation to assimilation ratio and the C/N ratio of the decomposing microbes and the rate of decomposition.

The flux of N in litter fall / root death is calculated as:

$$FN_{lf} = (1 - frN_{re,lv}) \cdot k_{lf} \cdot Am_{lv} \cdot ctN_{lv} \quad (10a)$$

$$FN_{rd} = (1 - frN_{re,rt}) \cdot k_{rd} \cdot Am_{rd} \cdot ctN_{rt} \quad (10b)$$

where $frN_{re,lv/rt}$ is the reallocation fraction of N in leaves/roots.

Element contents in leaves and roots depend on the total (wet and dry) deposition of N according to:

$$\frac{dctN_{lv}}{dt} = k(ctN_{lv,dep} - ctN_{lv}) \quad (11a)$$

$$\frac{dctN_{rt}}{dt} = k(ctN_{rt,dep} - ctN_{rt}) \quad (11b)$$

where ctN_{lv} and ctN_{rt} are the N contents in leaves and roots ($mg\ kg^{-1}$), $ctN_{lv,dep}$ and $ctN_{rt,dep}$ are the N contents of leaves and roots in equilibrium with deposition ($mg\ kg^{-1}$) and k is a rate constant (a^{-1}). The N content in leaves in equilibrium with deposition was assumed to vary linearly between the minimum and maximum N content according to:

$$ctN_{lv,dep} = ctN_{lv,min} + (ctN_{lv,max} - ctN_{lv,min}) \cdot \left[\frac{FN_{ld} - FN_{ld,min}}{FN_{ld,max} - FN_{ld,min}} \right] \quad (12)$$

Where $ctN_{lv,min/max}$ is the equilibrium N content of leaves at deposition $FN_{ld,min/max}$

Nutrient uptake by the vegetation is calculated from the demand of nutrients for growth, litter fall and root turnover. Growth of stems is modelled with a logistic growth curve (Kros *et al.*, 1996). The parameters for the growth function, i.e. the maximum amount of stem mass ($kg\ ha^{-1}$), the growth rate constant (a^{-1}) and the time at which the amount of stems is half of the maximum amount were derived by de Vries for several soil-tree combinations. The element contents in branches and stem wood are model input and constant in time. The nutrient demand needed for growth for the tree compartments is calculated as the product of changes in biomass with nutrient contents.

Model calibration and application

CALIBRATION OF ORGANIC MATTER DYNAMICS

Model parameters which determine the flow of organic matter were optimised by calibration of the model on a chronosequence of Scots pine (*Pinus sylvestris*) stands in the Hulshorsterzand, Veluwe, the Netherlands (Van Berghem *et al.*, 1986; Emmer, 1995). This chronosequence comprised five primary succession forest stands on drift sand of 15, 30, 59, 95 and 124 years old (reference year 1989). Soils were classified as Haplic or Cambic Arenosols according to FAO-UNESCO (1988). The organic layer was classified as Mor type humus. The three oldest stands are plantations thinned to 650 trees ha^{-1} , the two youngest stands are established naturally.

To calibrate the model, the mass balance equations for organic matter (Eqns 1, 4 and 5) were solved analytically (see Annex A). Parameters were optimised using a simplex algorithm for non-linear curve fitting (Freijer, 1990). Fig. 2 gives the scheme in which order the parameters were optimised. Firstly, the model was calibrated to the pools of organic matter in the L-horizon, to obtain an optimised value of the sum of $k_{mi,lt}$ and $k_{tr,lt}$. Further calibration of the parameters to fit the pools in the F-horizon yielded

optimised values for $k_{tr,lt}$ and the sum of $k_{mi,lm}$ and $k_{tr,lm}$, while calibration to the H-horizon yielded optimised values for $k_{tr,lm}$ and $k_{mi,hu}$. The optimised values for $k_{mi,lt}$ and $k_{mi,lm}$ were calculated by subtracting $k_{tr,lt}$ and $k_{tr,lm}$ from the sums of $k_{mi,lt} + k_{tr,lt}$ and $k_{mi,lm} + k_{tr,lm}$, respectively.

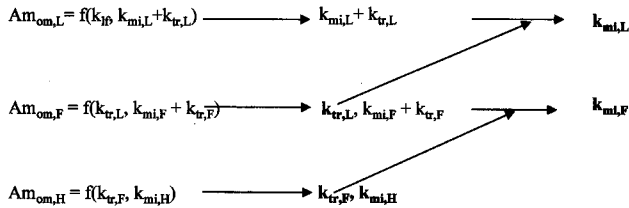

Fig. 2. Calibration scheme.

Maximum litter input from leaves and roots was treated as model input with an estimated maximum leaf litter input of $3025 \text{ kg ha}^{-1} \text{ a}^{-1}$ (De Vries, 1994). This value was calculated from the total maximum amount of leaves of 5500 kg ha^{-1} and a constant leaf-fall rate of 0.55 a^{-1} . Extrapolating the data of Berg *et al.* (1995) to a latitude of 52° and assuming that needle fall is 75% of (fine) litter fall gives a somewhat higher litter fall rate of $3700 \text{ kg ha}^{-1} \text{ a}^{-1}$. From litter fall measurements (Emmer, 1995) during one year at three of the five sites (the 59, 95 and the 124-year-old stand), a litter fall rate of $5000 \text{ kg ha}^{-1} \text{ a}^{-1}$ was calculated. These values are expected to be higher than the average litter fall rate due to relatively dry weather during the growing season in the year of measurements (Emmer, 1995). The model was calibrated for both the lowest ($3025 \text{ kg ha}^{-1} \text{ a}^{-1}$) and highest ($5000 \text{ kg ha}^{-1} \text{ a}^{-1}$) estimated litter fall rate. The exponential leaf growth rate ($k_{gr,lv}$) was set to 0.1 a^{-1} ; this will result in almost 90% of the maximum amount of leaves when the trees are 20 years old.

The maximum mass of fine roots, set at 5000 kg ha^{-1} and the turnover rate of roots at 1.4 a^{-1} yield a maximum annual input of 7000 kg ha^{-1} . Of the roots, 30–50% is assumed to be present in the litter layer and 70–50% in the mineral soil (De Vries, 1994). Model calibrations were carried out for 30 and 50% of roots in the litter layer. Roots in the litter layer were evenly distributed over the F and H-layer. The exponential rate constant for root growth ($k_{gr,rt}$) was set to 0.1 a^{-1} in the F-layer and mineral soil such that after 20 years the root mass is at 90% of its maximum. According to De Vries *et al.* (1990), root litter input is quite constant for stands older than 20 years. Because of the later appearance of the H-layer the exponential root growth constant ($k_{gr,rt}$) in the H-layer, was set to 0.05 a^{-1} .

For the calibration, it was assumed that no organic matter from the organic layer was translocated to the mineral soil because bio-turbation was absent (Emmer, 1995). Decomposition rates of root material were assumed to be equal to decomposition rates of needle litter. This assumption is based both on the good correlation between and the

almost equal average values for first year's mass loss rates as measured with litterbags for leaf and root material for Scots pine (Johansson, 1982).

For this calibration, it was assumed that rate constants were constant during the whole calibration period (i.e. up to 124 years). Stand properties may change during the development of a forest stand but Berg and Staaf (1980a) concluded that, rather than stand environment, it is the inherent properties of needle litter which govern the decomposition rate in four pine stands of different ages. Because temperature and moisture effects were not taken into account in the calibration, optimised parameter values represent yearly average values.

SIMULATION OF ORGANIC MATTER POOLS IN THE MINERAL SOIL

For the simulation of organic matter in the mineral soil, the optimised parameters for mineralisation and transformation of calibration 1 were used on the assumption that bio-turbation was absent. This implies that organic matter input to the mineral soil is only because of the turnover of roots. Estimates of total litter input by root turnover were 7000 kg ha^{-1} , of which 2100 kg ha^{-1} is added to the organic layer and 4900 kg ha^{-1} is added to the mineral soil layer. Roots are distributed over the soil profile according to a fixed distribution function. The root growth exponent $k_{gr,rt}$ for the mineral soil was set at 0.1 a^{-1} .

MODEL APPLICATION TO SIMULATE NITROGEN DYNAMICS

To compare simulated and measured pools of N in the three horizons of the organic layer, simulations with NUCSAM were carried out for all five stands. Simulations were started when the vegetation was five years old (i.e. in 1979, 1964, 1935, 1899 and 1870 for the stands of 15, 30, 59, 95 and 124 years old, respectively) and continued until the end of 1989. Table 1 gives the most relevant model input. N contents in leaves at the start of the simulation were assumed to be equal to those measured for the 15-year-old stand, which was also used as the minimum N content in leaves. N contents in the organic layer at the start of the simulations were set equal to the minimum N content in leaves.

Deposition of NO_x , NH_x and SO_x from 1870 onwards had to be estimated. For the period from 1950–1990, the deposition data used were calculated for Scots pine in the Veluwe region (Tiktak *et al.*, 1997). For the period 1920–1950, deposition data were estimated from emissions in the period 1920–1980. Firstly, linear regression equations were derived between deposition and emission for the period 1950–1980. These regression equations were used to estimate the deposition from emission data for the period 1920–1950. For the period 1870–1900, a background

Table 1. Overview of relevant model input.

Parameter	Description	Value	Unit	Derivation
$Am_{st,max}$	maximum amount of stem mass	105060	kg.ha ⁻¹	De Vries <i>et al.</i> (1990)
$kr_{gr,l}$	logistic growth rate	0.085	a ⁻¹	De Vries <i>et al.</i> (1990)
$Am_{lv,max}$	maximum amount leaves	5500	kg.ha ⁻¹	De Vries <i>et al.</i> (1994)
$kr_{gr,lv}$	leaf growth rate	0.10	a ⁻¹	this paper
$Am_{rt,max}$	maximum amount roots	5000	kg.ha ⁻¹	De Vries <i>et al.</i> (1994)
$kr_{gr,rt}$	root growth rate	0.1	a ⁻¹	this paper
t_{50}	time at which stems are at 50% of $Am_{st,max}$	34	a ⁻¹	De Vries <i>et al.</i> (1990)
$ctN_{lv,min}$	minimum N content leaves	0.8	%	this paper
$ctN_{lv,max}$	maximum N content leaves	3.0	%	De Vries <i>et al.</i> (1994)
$ctN_{rt,min}$	minimum N content roots	0.4	%	De Vries <i>et al.</i> (1994)
$ctN_{rt,max}$	maximum N content roots	0.8	%	De Vries <i>et al.</i> (1994)
ctN_{br}	N content branches	0.3	%	De Vries <i>et al.</i> (1990)
CtN_{st}	N content stems	0.08	%	De Vries <i>et al.</i> (1990)

deposition for NO_x, NH_x and SO_x of respectively 200, 300 and 300 mol ha⁻¹ a⁻¹ was used and, for the period 1900–1920, a linear increase of the deposition from the levels of 1900 to the levels of 1920 was assumed. Fig. 3 shows the deposition as used for the model simulations.

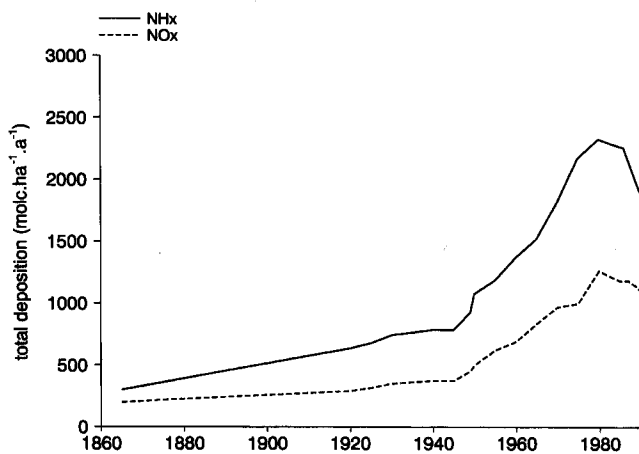

Fig. 3. Estimated trends in NO_x and NH_x deposition between 1860 and 1990 in the Veluwe region in the Netherlands.

Results and discussion

MEASURED AND SIMULATED TRENDS IN ORGANIC MATTER POOLS IN THE ORGANIC LAYER

Fig. 4 shows the measured and simulated pools of organic matter in time for the calibration (calibration run 1, see Table 2) with a maximum above ground litter input of 3025 kg ha⁻¹ a⁻¹ and a root litter input of 2100 kg ha⁻¹ a⁻¹. Simulated pools of organic matter in the L and F horizon agree very well with the pools measured. However, simu-

lated pools of organic matter in the H horizon are much too high for at least the first thirty years. In the 15 and 30 years old stands, no H horizon was identified in the field but the model simulated already considerable pools (almost 20 tons ha⁻¹ at 30 years) of organic matter in the H horizon. Changes in litter and root input rates did not improve the simulation results with respect to the first 30 years of organic matter in the H-horizon. Lowering the growth rate of roots in the organic layer improved model results slightly but considerable pools of organic matter are still simulated after 30 years (13 tons ha⁻¹). Furthermore, calibration with this low growth rate for roots resulted in almost equal mineralisation rates for fermented and humic material (0.03 and 0.02 a⁻¹ respectively); this would make differentiation between fermented and humic material unnecessary and has the consequence that there is no stable organic matter compartment.

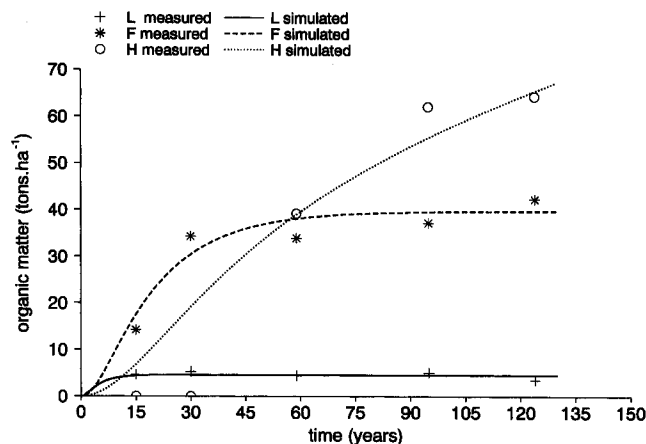

Fig. 4. Comparison between measured and simulated organic matter pools in the organic layer of a chronosequence of five Scots pine stands in the Netherlands.

Table 2. Optimised parameter values of the calibrations.

	calibration 1	calibration 2	calibration 3
leaf litter input (kg.ha ⁻¹ .a ⁻¹)	3025	5000	3025
root turnover (kg.ha ⁻¹ .a ⁻¹)	2000	2000	3000
k _{mi,lt} (a ⁻¹)	0.29	0.76	0.35
k _{tr,lt} (a ⁻¹)	0.37	0.33	0.31
k _{mi,fm} (a ⁻¹)	0.046	0.046	0.051
k _{tr,fm} (a ⁻¹)	0.013	0.013	0.007
k _{mi,hu} (a ⁻¹)	0.005	0.005	0.005

Table 2 gives the optimised values of the decomposition parameters for the three calibration runs. For all three calibrations, there was a pronounced decline in mineralisation rates with increasing stage of decomposition. For all three calibration runs, the value of the mineralisation rate of humus ($k_{mi,hu}$) was fixed at a value of 0.005 a⁻¹; otherwise optimisation resulted in negative values for this parameter. A value of around 0.005 a⁻¹ corresponds with turnover times of several hundred years as reported for stable organic matter (Balesdent, 1996). Compared to calibration 1, the calibration 2, with a higher leaf litter input, resulted in higher mass loss rate constants ($k_{mi,lt}+k_{tr,lt}$) for litter material; especially, the mineralisation rate for litter material (0.76 a⁻¹) increased markedly, whereas parameters for fermented and humic material remained unchanged. Such a value is most likely too high for mineralisation rates determined for fresh litter in a temperate climate (Janssen, 1984 and De Vries *et al.*, 1990). When the input of organic matter by root turnover in the F and H-horizons is increased (calibration 3 in Table 1), the optimised values for the mineralisation rate of fermented material increases slightly whereas the transformation rate of fermented to humic material decreases slightly (compare calibration 3 with calibration 1). However, the goodness of fit, as determined by the sum of squares of errors, decreased compared to the calibration with lower root turnover rates (calibration 1). Especially, the pools of the humus compartment after 15 and 30 years increased when compared with calibration 1, which already overestimated the pool of organic matter in the H horizon during the first thirty years. Because calibration 1 gave reasonable results and calibrations 2 and 3 did not give any improvement, the values from the first calibration are used in the further analysis.

MEASURED AND SIMULATED TRENDS IN ORGANIC MATTER POOLS IN THE MINERAL LAYER

Besides the organic layer, the mineral soil is also an important store of organic matter and nutrients. Litter input by the turnover of roots in the mineral soil can be as high as above ground litter input (de Vries 1994). Total maximum litter input (leaves and roots) amounts 10025 kg ha⁻¹ of

which almost 50% is added to the mineral soil. It is, therefore, important to compare simulated and measured pools of organic matter not only in the litter layer but also in the mineral layer. Emmer (1995) measured the organic matter contents in the mineral soil horizons of five Scots pine stands when they were 23, 38, 63, 99 and 128 years old (reference year 1993). Furthermore, the thickness of each horizon was measured, but the depth to which the C-horizon was sampled is not indicated. It was assumed that measurements of C contents in the C-horizon could be extrapolated from the depth at which the horizon begins to 40 cm depth below the soil surface. From the measured C contents and the bulk densities estimated by Emmer (1995), from a regression between bulk density and organic matter content, the pools of organic matter in each horizon were calculated. These pools are a rough estimate only, because of the uncertainty in bulk density and because of the assumption that measured contents in the deepest horizon are valid to a depth of 40 cm.

Fig. 5 shows the simulated and 'measured' pools of organic matter to a depth of 40 cm in the pine stands with different ages. Simulated pools of organic matter agree well with measured pools except for the stand of 99 years, which seems to be an outlier. In the simulations, however,

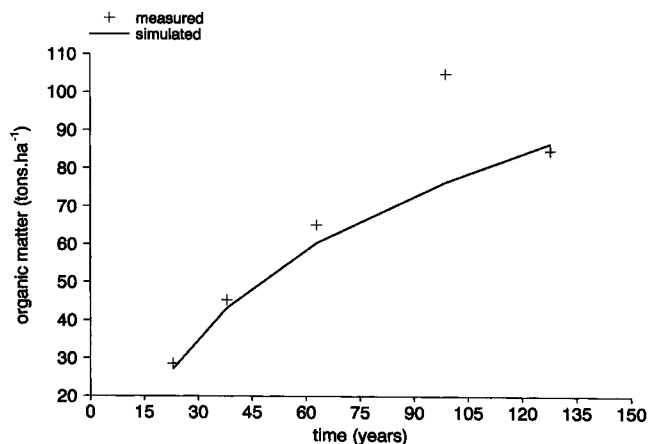

Fig. 5. Comparison between measured and simulated organic matter in the mineral layer (0–40 cm) of a chronosequence of five Scots pine stands in the Netherlands.

organic matter already present in the soil in the year of afforestation was not taken into account. Although C contents in bare sand were very low, it must be concluded that, for the mineral soil also, simulated pools of total C are too high during the first thirty years. After that period, much of the original C will be mineralised and will be a negligible fraction compared to the newly formed organic matter.

The accumulation of organic matter in the mineral soil for these sites could be described with the model parameters which were optimised by calibration on organic matter pools in the organic layer. Obviously, these poor sandy soils, which contain almost no clay or oxides, are not able to protect organic matter chemically or physically from decay.

According to the simulations, accumulation of organic matter in the topsoil (40 cm) could be attributed solely to the input of organic matter by roots. Because bio-turbation in this system is absent, above ground organic matter can only be transported within water as DOC and some particulate organic matter. Transport of DOC is expected to play only a minor role for organic matter accumulation in the top soil because the input of organic matter by DOC is small compared to that of root turnover. From an average water flux of 500 mm a⁻¹ and an average DOC concentration of 100 g m⁻³ at the soil surface and a flux of 200 mm a⁻¹ and concentration of 20 g m⁻³ at the bottom of the root zone, a retention is estimated to be around 500 kg ha⁻¹ a⁻¹ DOC. This value lies between the estimated fluxes of DOC into the mineral soil of 300 kg ha⁻¹ a⁻¹ (Guggenberger and Zech, 1993) and 800 kg ha⁻¹ a⁻¹ by (Qualls *et al.*, 1991) and is only 10% of the input by root turnover. Furthermore, studies of DOC budgets show that the upper horizon does not retain significant amounts of DOC which is retained mainly in the B horizon of the soil (Guggenberger *et al.*, 1998)

COMPARISON WITH ORGANIC MATTER POOLS IN THE ORGANIC LAYER OF OTHER SCOTS PINE STANDS

Within an inventory of 150 forest stands in the Netherlands (De Vries and Leeters, 1998), the pools of organic matter in the L+F horizon (sampled together) and H horizon were determined. Simulated and measured total pools of organic C (L+F+H) in the organic layer compared well (see Fig. 6). Fig. 7 compares the simulated pools with those measured in the inventory for Scots pine stands on several soils. Fig. 7 shows that, in the pools of organic matter for the different stands, there is a large variation; this is caused by differences in stand properties (i.e. succession, stand density, management), soil properties and differences in activity of soil fauna. Simulated pools for L+F are low compared to measured pools. Larger pools in the field may be due either to lower mineralisation rates of litter and fermented material or to

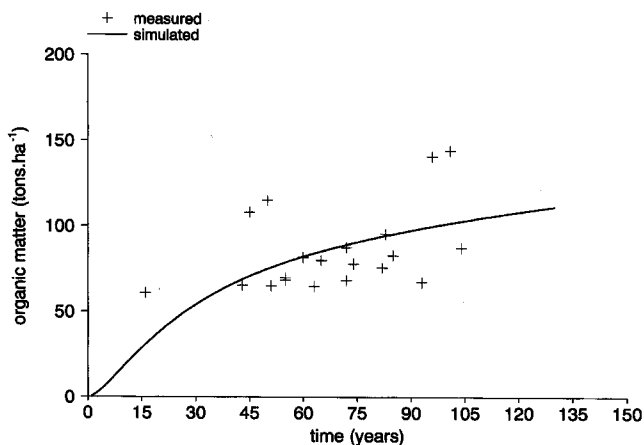

Fig. 6. Comparison between the sum of simulated pools of organic matter in LF and H horizons with field measurements for 20 Scots pine stands.

higher litter input. Furthermore, differences in sampling (e.g. separation of the three organic horizons) may have resulted in different estimates for the pools in the L, F and H horizons. According to Federer (1982), separating F and H horizons of the organic layer is very subjective. Comparison of the data from Emmer (1995) with those of Van Berghem *et al.* (1986) for the same stands shows large differences between measured organic matter pools in the compartments. In the simulation the development of the organic H horizon starts too early. Field measurements show that it starts to appear after more than 30 years. In contrast to the L+F horizon simulated pools, the simulated H horizon pool is high compared to measured pools. This may be due to a greater translocation of humified material to the mineral soil by soil organisms, which were absent or negligible in the stand used for calibration.

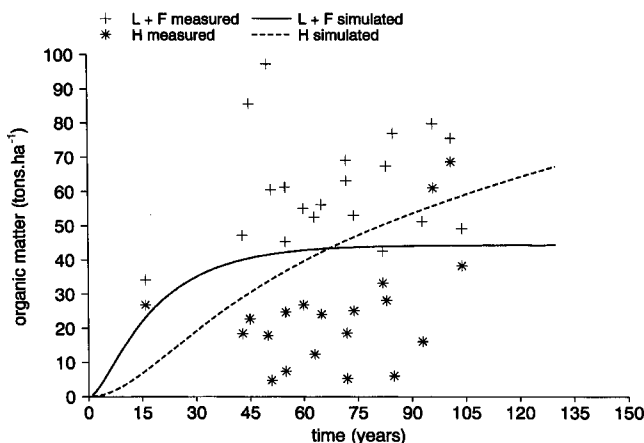

Fig. 7. Comparison between simulated pools of organic matter in LF and H horizons with field measurements for 20 Scots pine stands.

MEASURED AND SIMULATED TRENDS IN NITROGEN POOLS IN THE ORGANIC LAYER

NUCSAM had difficulty in simulating the N dynamics of organic matter as the N demand calculated by the model exceeded the N supply by deposition. Also, initial pools of N in the mineral soil were very low. The problem of N shortage was also recognised by Tietema (1997) who calculated N budgets for (almost) the same chronosequence of Scots pine stands. Despite the N shortage, model results for N contents were compared with measured N contents in the organic layer. The simulated and measured N contents of the organic horizons are highlighted in Table 3 and Fig. 8 shows the simulated and measured pools of N.

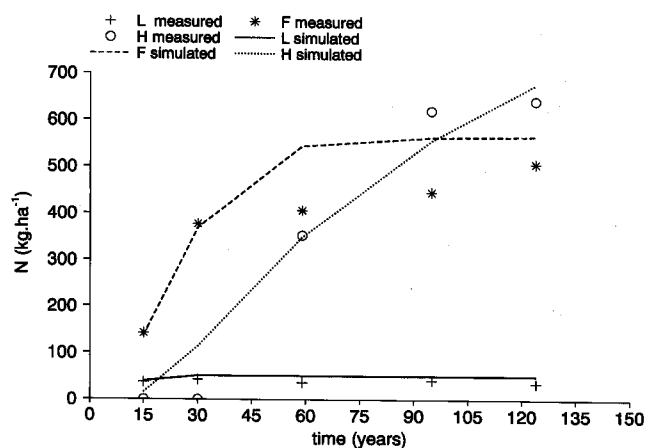

Fig. 8. Comparison between measured and simulated nitrogen pools in the organic layer of a chronosequence of five Scots pine stands in the Netherlands.

N contents in the L horizon are overestimated by approximately 20% for all ages. The measured trend of an increase in N content with increasing stand age is, however, simulated adequately in the model, although, in the model, N increases slightly too fast. The overestimation of N contents in the L horizon may be due to the simulation of too high an N content in freshly fallen litter. In NUCSAM, the N content in leaves and roots depends solely on the deposition of N while a low N availability in the soil will influence N content in leaves as well. The minimum N content in leaves was set equal to the N content in the freshly fallen litter of the 15-year-old stand, i.e. 0.8%

Table 3. Simulated and measured N contents in the organic layer.

horizon	stand age									
	15		30		59		95		124	
	meas.	sim.	meas.	sim.	meas.	sim.	meas.	sim.	meas.	sim.
L	0.8	0.9	0.8	1.1	0.8	1.1	0.8	1.1	1.0	1.2
F	1.0	0.8	1.1	1.2	1.2	1.4	1.2	1.4	1.2	1.4
H	—	0.5	—	0.9	0.9	1.0	1.0	1.0	1.0	1.0

which is low compared to nitrogen content reported in the literature (De Vries *et al.*, 1990). Simulated N contents in litter were too high which may also result from too high a retention of N in the litter component of the model.

N contents in the F horizon are overestimated as well. The model simulates the observed increase of N content in the F horizon compared to the L horizon which can be attributed to the slower mineralisation of N compared to the mineralisation of C. Fig. 8 shows, however, a rapid increase of the N pool in the F-horizon which results from the high N content simulated for the L horizon. Furthermore, retention of N in the F horizon may be overestimated. Nitrogen retention depends on the C/N ratio and on the dissimilation to assimilation ratio of the decomposing organisms. For the simulations, equal C/N and dissimilation to assimilation ratios are used for the decomposers of the three organic matter compartments.

Simulated N contents in the H horizon agree with the measured content of the stands ≥ 60 years. The model simulates the observed phenomenon that N content in the H horizon is lower than in the F horizon. Low decomposition rates in the H horizon slow down the increase in N content.

Conclusions

The model concept with three successive decay stadia is able to simulate the accumulation of organic matter in the L and F horizons of the organic layer. However, irrespective of the values used for model parameters, the model, simulates too early a development of an H horizon. Organic matter pools in H horizons of forest stands of ≥ 60 years are appropriate.

The results of the simulation of organic matter accumulation in the mineral top soil using model parameters optimised for the organic layer suggest that decay of organic matter in the soil does not differ from that in the organic layer of poor sandy soils. Physical and chemical protection against decay is very low in these soils as a result of low clay and oxide contents. According to the model results, accumulation of organic matter in the top mineral soil can be explained fully by root turnover. This is consistent with the absence of bio turbation in these soils and with the fact that DOC does not contribute to organic matter accumulation in the mineral top soil. The importance of roots in the

dynamics of soil organic matter has received too little attention in both experimental research and modelling.

The model is only partly successful in simulating N dynamics although. It is able to simulate the increase with N content in time in all three organic layers. This reflects the increase in N content of leaves and roots with time and the reduced mineralisation of N compared to C. Furthermore, the model simulates, correctly, the trend of differences in the N content of the distinguishable organic horizons which also supports the model concept in which N mineralisation is reduced compared to C mineralisation. N contents in the L and F horizon, however, increase too rapidly and simulated levels are subsequently too high. This may arise from errors in the empirical description of increasing N contents in foliage with increased deposition, or result from a too high retention of N in the litter compartment. The modelling of the N content in leaves and roots should be changed to a description in which N contents are related to N uptake by roots and foliage.

Acknowledgements

This work is supported by the Commission of European Communities (DYNAMO project ENV4-CT95-0030).

References

- Aalst, R.M. van, 1984. *Verzuring door atmosferische depositie. Atmosferische processen en depositie*. Ministerie van Landbouw Natuurbeheer en Visserij, Ministerie van Ruimtelijke Ordening en Milieu, Den Haag (Netherlands). PublikatierEEKS in milieubeheer 84. (in Dutch)
- Aber, J.D., Nadelhoffer, K.J., Steudler, P. and Mellilo, J.M., 1989. Nitrogen saturation in northern forest ecosystems. *Bioscience*, **39**, 378–386.
- Ågren, G.I. and Bossata, E., 1988. Nitrogen saturation of terrestrial ecosystems. *Environ. Pollut.*, **54**, 185–197.
- Balesdent, J., 1996. The significance of organic separates to carbon dynamics and its modelling in some cultivated soils. *European J. Soil Sci.*, **47**, 485–493.
- Berg, B., 1984. Decomposition of root litter and some factors regulating the process: long-term root litter decomposition in a Scots pine forest. *Soil Biol. Biochem.*, **16**, 609–617.
- Berg, B. and Staaf, H., 1980. Decomposition and chemical changes of scots pine needle litter. I. Influence of stand age. *Ecol. Bull. (Stockholm)*, **32**, 363–372.
- Berg, B., McLaugherty, C., Virzo de Santo, A., Johansson, M.B. and Ekbohm, G., 1995. Decomposition of litter and soil organic matter—can we distinguish a mechanism for soil organic matter buildup? *Scand. J. For. Res.*, **10**, 108–119
- Boumans, L.J.M. and Beltman, W., 1991. *Kwaliteit van het bovenste freatisch grond water in de zandgronden van Nederland onder bos- en heidevelden*. Bilthoven, Rijks Instituut voor Volksgezondheid en Milieuhygiene, Rapport 724901001, 65 pp.
- Bredemeier, M., Tiktak, A. and van Heerden, K., 1995. The Solling Norway spruce site. *Ecol. Model.*, **83**, 7–15.
- Chertov, O.G. and Komarov, A.S., 1997. SOMM: A model of soil organic matter dynamics. *Ecol. Model.*, **94**, 177–189.
- Cosby, B.J., Ferrier, R.C., Jenkins, A., Emmett, B.A., R.F. Wright and Tietema, A., 1997. Modelling the ecosystem effects of nitrogen deposition: Model of Ecosystem Retention and Loss of Inorganic Nitrogen (MERLIN). *Hydrol. Earth System Sci.*, **1**, 137–158.
- De Vries, W., Hol, A., Tjalma, S. and Voogd, J.C.H., 1990. *Literatuurstudie naar voorraden en verblijftijden van elementen in bosecosystemen*. Wageningen, DLO Winand Staring Centre, Report 94. (in Dutch).
- De Vries, W., 1994. *Soil response to acid deposition at different regional scales. Field and laboratory data, critical loads and model predictions*. Doctoral thesis. Agricultural University, Wageningen, the Netherlands; 487pp.
- De Vries, W. and Leeters, E.E.J.M., 1998. *1. Chemical composition of the humus layer, mineral soil and soil solution*. Wageningen. DLO Winand Staring Centre, Report 69.1.
- De Vries, W. de, Kros, J. and van der Salm, C., 1995. Modelling the impact of acid deposition and nutrient cycling in forest soils. *Ecol. Model.*, **79**, 231–254.
- Emmer, I.M., 1995. *Humus form and soil development during a primary succession of monoculture Pinus sylvestris forests on poor sandy substrates*. Ph. D. thesis, University of Amsterdam.
- Emmer, I.M. and Sevink, J., 1994. Temporal and vertical changes in the humus form profile during a primary succession of Pinus sylvestris. *Plant Soil.*, **167**, 281–295.
- FAO-UNESCO, 1988. *Soil Map of the World (Revised legend)*. ISRIC technical paper 20.
- Freijer, J.I., 1990. *SIMPLEX: Non-linear curve fitting algorithm*. Computer documentation Simplex Program Package version 1.0 4-1-1990. University of Amsterdam, Laboratory of Physical Geography and Soil Science report 39. 17 pp.
- Groenenberg, B.-J., Kros, H., van der Salm, C. and de Vries, W., 1995. Application of the model NUCSAM to the Solling spruce site. *Ecol. Model.*, **83**, 97–107.
- Guggenberger, G. and Zech, W., 1993. Zur Dynamik gelöster organischer Substanzen (DOM) in Fichtenokosystemen—Ergebnisse analytischer DOM-Fraktionierung. *Z. Pflanzenernah. Bodenk.*, **156**, 341–347
- Guggenberger, G., Kaiser, K. and Zech, W., 1998. Mobilization and immobilization of dissolved organic matter in forest soils. *Z. Pflanzenernah. Bodenk.*, **161**, 401–408.
- Gundersen, P., Emmett, B.A., Kjonaas, O.J., Koopmans, C.J., Tietema, A., Wright, R.F. and Rasmussen, L., 1998. Impact of nitrogen deposition on nitrogen cycling in forests: a synthesis of NITREX data. *For. Ecol. Manage.*, **101**, 37–55.
- Janssen, B.H., 1984. A simple method for calculating decomposition and accumulation of young organic matter. *Plant Soil*, **76**, 297–304.
- Jenkinson, D.S. and Rayner, J.H., 1977. The turnover of soil organic matter in some of the Rothamsted classical experiments. *Soil Sci.*, **123**, 298–305.
- Johansson, M.B., 1982. *Decomposition of leaf and root litters from some coniferous and broad-leaved trees at sites located in different parts of Sweden*. Swedish Agricultural University, Uppsala. Reports in Forest Ecology and Forest Soils, **42**, 28 p.
- Kros, J., Groenenberg, J.E., van der Salm, C., de Vries, W. and Reinds, G.J., 1996. *Validation and application of soil acidification models at local, national and European scale*. Wageningen, DLO Winand Staring Centre Report 98. 125 pp.
- McLaugherty, C.A., Aber, J.D. and Melillo, J.M., 1984.

Decomposition dynamics of fine roots in forested ecosystems. *Oikos*, 42, 378–386.

Parton, W.J., Schimel, D.S., Cole, C.V. and Ojima, D.S., 1987. Analysis of factors controlling soil organic matter levels in Great Plains Grasslands. *Soil Sci. Soc. Am. J.*, 51, 1173–1179.

Qualls, R.G., Haines, B.L. and Swank, W.T., 1991. Fluxes of dissolved organic nutrients and humic substances in a deciduous forest. *Ecology*, 72, 254–266.

Tiktak, A., van Grinsven, J.J.M., Groenenberg, J.E., van Heerden, C., Janssen, P.H.M., Kros, J., Mohren, G.M.J., van der Salm, C., van de Veen, J.R. and de Vries, W., 1997. Application of three forest soil-atmosphere models to the Speuld experimental forest. In: *Acid Atmospheric Deposition and its Effects on Terrestrial Ecosystems in The Netherlands* (G.J. Heij and J.W. Erisman (Eds.)). Elsevier Science, Amsterdam, p 455–606.

Tietema, A., 1992. *Nitrogen cycling and soil acidification in forest ecosystems in the Netherlands*. Ph.D. thesis, University of Amsterdam, 139 pp.

Tietema, A., 1997. *Meten en modelleren van nitraatuitspoeling vanuit bossen op de Veluwe*. Amsterdam, Rapport Nr. 68, Fysische Geografie en Bodemkunde, Universiteit van Amsterdam (in Dutch).

Van Berghem, J.W., Mettievier Meyer, H.J.B., Sevink, J. and Verstraten, J. M., 1986. Studies on organic soil profiles II: succession of organic matter profiles in the Hulshorsterzand. In: *Forest dynamics research in Western and Central Europe* (J. Fanta (Ed.)). Proceedings of the workshop held 17–20 September in Wageningen, The Netherlands. Pudoc Wageningen.

Van Dam, D. and Van Breemen, N., 1995. NICCCE: a model for cycling of nitrogen and carbon isotopes in coniferous forest ecosystems. *Ecol. Model.*, 79, 255–275.

Van Breemen, N., Visser, W.J.F. and Pape, Th., 1988. *Biogeochemistry of an oak-wood land system in the Netherlands affected by acid atmospheric deposition*. Agricultural Research Report 930. Pudoc Wageningen, 197 pp.

$$Am_{om,H} = Am_{li,H} + Am_{fm,H} + Am_{hu,H} \quad (A3)$$

The pools of organic matter in the different compartments are calculated according to:

$$Am_{li,L} = \frac{k_{lf} \cdot Am_{lv,max}}{p} \left[1 - \frac{pe^{-s \cdot t}}{(p-s)} + \frac{se^{-p \cdot t}}{(p-s)} \right] \quad (A4)$$

$$Am_{li,F} = \frac{k_{rd} \cdot Am_{rt,max} \cdot frrt_F}{p} \left[1 - \frac{pe^{-s \cdot t}}{(p-s)} + \frac{se^{-p \cdot t}}{(p-s)} \right] \quad (A5)$$

$$Am_{fm,F} = \frac{k_{lf} \cdot Am_{lv,max} \cdot k_{rd} \cdot Am_{rt,max} \cdot fvrt_F \cdot k_{tr,lt}}{p} \left[1 - \frac{qse^{-p \cdot t}}{(p-q) \cdot (p-s)} + \frac{pse^{-q \cdot t}}{(p-q)(q-s)} \right. \\ \left. \frac{pqe^{-s \cdot t}}{(p-s) \cdot (q-s)} \right] \quad (A6)$$

$$Am_{li,H} = \frac{k_{rd} \cdot Am_{rt,max} \cdot frrt_H}{p} \left[1 - \frac{pe^{-v \cdot t}}{(p-v)} + \frac{se^{-p \cdot t}}{(p-v)} \right] \quad (A7)$$

$$Am_{fm,H} = \frac{k_{rd} \cdot Am_{rt,max} \cdot frrt_H \cdot k_{tr,fm}}{pq} \left[1 - \frac{qse^{-p \cdot t}}{(p-q) \cdot (p-s)} + \frac{pse^{-q \cdot t}}{(p-q) \cdot (q-s)} \right. \\ \left. \frac{pqe^{-s \cdot t}}{(p-s) \cdot (q-s)} \right] \quad (A8)$$

$$Am_{hu,H} = \frac{k_{tr,lt} \cdot k_{tr,fm}}{pqr} \left[\frac{qr \left((k_{lf} \cdot Am_{lv,max} + k_{rd} \cdot Am_{rt,max} \cdot frrt_F) \cdot s(p-v) + k_{rd} \cdot Am_{rt,max} \cdot frrt_H \cdot r(p-s) \right) e^{-p \cdot t}}{(p-q) \cdot (p-r) \cdot (p-s) \cdot (p-v)} \right. \\ + \frac{pr \left((k_{lf} \cdot Am_{lv,max} + k_{rd} \cdot Am_{rt,max} \cdot frrt_F) \cdot s(p-v) + k_{rd} \cdot Am_{rt,max} \cdot frrt_H \cdot v(q-s) \right) e^{-q \cdot t}}{(p-q) \cdot (p-r) \cdot (p-s) \cdot (p-v)} \\ + \frac{pq \left((k_{lf} \cdot Am_{lv,max} + k_{rd} \cdot Am_{rt,max} \cdot frrt_F) \cdot s(r-v) + k_{rd} \cdot Am_{rt,max} \cdot fvrt_H \cdot v(r-s) \right) e^{-r \cdot t}}{(p-q) \cdot (p-r) \cdot (p-s) \cdot (p-v)} \\ \left. \frac{(k_{lf} \cdot Am_{lv,max} + k_{rd} \cdot Am_{rt,max} \cdot frrt_F) \cdot pqre^{-s \cdot t}}{(p-s) \cdot (q-s) \cdot (r-s)} - \frac{k_{rd} \cdot Am_{rt,max} \cdot frrt_H \cdot pqre^{-v \cdot t}}{(p-v) \cdot (q-v) \cdot (r-v)} \right] \quad (A9)$$

Annex A

The amount of organic matter in the L, F and H horizons of the organic layer are described with equations A1–A3:

$$Am_{om,L} = Am_{li,L} \quad (A1)$$

$$Am_{om,F} = Am_{li,F} + Am_{fm,F} \quad (A2)$$

with: $p = k_{mi,lt} + k_{tr,lt}$
 $q = k_{mi,fm} + k_{tr,fm}$
 $r = k_{mi,hu}$
 $s = k_{gs,lv} = k_{gr,rt,F}$
 $v = k_{gr,rt,H}$
 $frrt_F =$ fraction of roots in F-layer
 $frrt_H =$ fraction of roots in H-layer