



**HAL**  
open science

# Mixing ratios and eddy covariance flux measurements of volatile organic compounds from an urban canopy (Manchester, UK)

B. Langford, B. Davison, E. Nemitz, C. N. Hewitt

► **To cite this version:**

B. Langford, B. Davison, E. Nemitz, C. N. Hewitt. Mixing ratios and eddy covariance flux measurements of volatile organic compounds from an urban canopy (Manchester, UK). *Atmospheric Chemistry and Physics Discussions*, 2008, 8 (1), pp.245-284. hal-00303238

**HAL Id: hal-00303238**

**<https://hal.science/hal-00303238>**

Submitted on 18 Jun 2008

**HAL** is a multi-disciplinary open access archive for the deposit and dissemination of scientific research documents, whether they are published or not. The documents may come from teaching and research institutions in France or abroad, or from public or private research centers.

L'archive ouverte pluridisciplinaire **HAL**, est destinée au dépôt et à la diffusion de documents scientifiques de niveau recherche, publiés ou non, émanant des établissements d'enseignement et de recherche français ou étrangers, des laboratoires publics ou privés.

**Eddy covariance flux  
measurements of  
VOC from a city**

B. Langford et al.

# Mixing ratios and eddy covariance flux measurements of volatile organic compounds from an urban canopy (Manchester, UK)

B. Langford<sup>1</sup>, B. Davison<sup>1</sup>, E. Nemitz<sup>2</sup>, and C. N. Hewitt<sup>1</sup>

<sup>1</sup>Lancaster Environment Centre, Lancaster University, Lancaster, LA1 4YQ, UK

<sup>2</sup>Centre for Ecology & Hydrology (CEH) Edinburgh, Bush Estate, Penicuik, EH26 0QB, UK

Received: 13 November 2007 – Accepted: 5 December 2007 – Published: 8 January 2008

Correspondence to: C. N. Hewitt (n.hewitt@lancaster.ac.uk)

Title Page

Abstract

Introduction

Conclusions

References

Tables

Figures

◀

▶

◀

▶

Back

Close

Full Screen / Esc

Printer-friendly Version

Interactive Discussion

## Abstract

Concentrations and fluxes of six volatile organic compounds (VOC) were measured above the city of Manchester (UK) during the summer of 2006. A proton transfer reaction-mass spectrometer was used for the measurement of concentrations, and fluxes were calculated using both the disjunct and the virtual disjunct eddy covariance techniques. The two flux systems, which operated in alternate half hours, showed reasonable agreement, with  $R^2$  values ranging between 0.2 and 0.8 for the individual analytes. On average, fluxes measured in the disjunct mode were lower than those measured in the virtual mode by approximately 19%, of which at least 8% can be attributed to the differing measurement frequencies of the two systems and the subsequent attenuation of high frequency flux contributions. Observed fluxes are thought to be largely controlled by anthropogenic sources, with vehicle emissions the major contributor. However both evaporative and biogenic emissions may account for a fraction of the isoprene present. Fluxes of the oxygenated compounds were highest on average, ranging between  $60\text{--}89\ \mu\text{g m}^{-2}\ \text{h}^{-1}$ , whereas the fluxes of aromatic compounds were lower, between  $19\text{--}42\ \mu\text{g m}^{-2}\ \text{h}^{-1}$ . The observed fluxes of benzene were up-scaled to give a city wide emission estimate which was found to be significantly lower than that of the National Atmospheric Emissions Inventory (NAEI).

## 1 Introduction

The compilation of spatially and temporally detailed inventories for the emission of anthropogenic volatile organic compounds (VOCs) from urban areas is a necessary requirement for air quality regulatory purposes, effects assessment and research. Current emission estimates are associated with large degrees of uncertainty (Friedrich and Obermeier, 1999) which may limit their usefulness. Much of this uncertainty can be attributed to the large variety of different source categories which contribute to urban VOC emissions, which can be difficult to characterise and validate. Rather than

### Eddy covariance flux measurements of VOC from a city

B. Langford et al.

Title Page

Abstract

Introduction

Conclusions

References

Tables

Figures

◀

▶

◀

▶

Back

Close

Full Screen / Esc

Printer-friendly Version

Interactive Discussion

taking a “bottom-up” inventory approach, an alternative is to make direct micrometeorologically based measurements which can integrate observations of wind speed and scalar concentrations to give a city-wide flux estimate of pollutant emissions (Nemitz et al., 2002; Dorsey et al., 2002; Velasco et al., 2005).

5 Currently, the eddy covariance (EC) technique is considered the most direct micrometeorological method available for estimating surface / atmosphere exchange fluxes, as it measures the turbulent flux directly, without reliance on any empirical parameterisations. This approach requires high frequency measurements (typically in the order of 5–20 Hz) of both vertical wind speed and concentration to resolve all eddies that  
10 contribute to vertical transport (Lenschow, 1995). Although this technique is now well established for the measurement of some trace gases, such as CO<sub>2</sub> and H<sub>2</sub>O (Aubinet et al., 2001), its application to VOC fluxes has been restricted because of the slow response times of most VOC sensors.

A number of alternative micrometeorological approaches have been developed  
15 which relax the demands placed upon instrument response times. The technique most commonly applied to VOCs is the relaxed eddy accumulation method (REA), a conditional sampling technique where samples of air are directed into an up or down draught reservoir according to the sign of the vertical wind velocity at the time of sampling (Businger and Oncley, 1990). Air from each reservoir is subsequently analysed  
20 off-line and a flux is calculated from the difference in concentration generated between the two reservoirs. Unlike the eddy covariance method, REA is not a direct measure of the flux as it relies on empirical parameterisation. Furthermore, there is no scope for retrospective corrections to the coordinate frame (Bowling et al., 1998). Despite these drawbacks, the REA method has been successfully applied to a range of vegetation  
25 types including grass land (Olofsson et al., 2003) and forests (Greenberg et al., 2003; Ciccioli et al., 2003; Friedrichs et al., 1999).

More recently a second technique, disjunct eddy covariance (DEC), has been developed for “relaxed” flux measurement. Rather than measuring at high frequencies as in EC, in DEC the flux is calculated using a sub-set of a continuous time series. In

---

**Eddy covariance flux measurements of VOC from a city**B. Langford et al.

---

[Title Page](#)[Abstract](#)[Introduction](#)[Conclusions](#)[References](#)[Tables](#)[Figures](#)[⏪](#)[⏩](#)[◀](#)[▶](#)[Back](#)[Close](#)[Full Screen / Esc](#)[Printer-friendly Version](#)[Interactive Discussion](#)

order to retain the flux contributions carried by small scale eddies, DEC utilises near instantaneous grab samples of air which are aspirated into a storage reservoir at regular intervals. The “dead” time between the sampling periods is then used to analyse the air at a rate suitable for the gas analyser. Provided the interval between samples is kept to less than the integral time scale, then the discontinuous dataset can be used to give high precision flux information, which is numerically similar to the EC approach, but with reduced statistics (Grabmer et al., 2006). The DEC approach is particularly useful for sensors with a response time of 1 to 20 s.

With the advent of quadrupole mass spectrometers (QMS) for the use of atmospheric composition measurements, a range of analysers is now becoming available that can provide fast measurements (as determined by the dwell time on a given  $m/z$ ), which is nevertheless discontinuous (as the QMS scans through a range of  $m/z$ 's). One such instrument is the proton transfer reaction-mass spectrometer (PTR-MS) which allows for the measurement of most VOCs with good sensitivity (10 ppt) and fast response times (10 Hz).

The quadrupole mass spectrometer in the PTR-MS can be programmed to scan over a small suite of masses in what is termed a duty cycle. Although in theory the instrument has a sufficient response time to be compatible with the eddy covariance method, in reality the quadrapole can only scan one mass at a time; therefore the data set returned on completion of each duty cycle is in effect disjunct.

To optimise flux measurement approaches for these kind of data, the DEC concept has been developed further to calculate fluxes from the discontinuous time-series at each  $m/z$  by pairing up each concentration measurement with the associated wind measurement in software, a process known as virtual disjunct eddy covariance (vDEC) (Karl et al., 2001, 2002; Spirig et al., 2005; Lee et al., 2006; Ammann et al., 2006; Brunner et al., 2007). The advantage of this technique is that air can be sampled directly into the instrument, as individual masses are measured at a sufficiently fast rate, therefore no additional sampling system is required. Furthermore, analysis times are shorter than in DEC, allowing more data to be collected during each averaging

---

**Eddy covariance flux measurements of VOC from a city**B. Langford et al.

---

[Title Page](#)[Abstract](#)[Introduction](#)[Conclusions](#)[References](#)[Tables](#)[Figures](#)[⏪](#)[⏩](#)[◀](#)[▶](#)[Back](#)[Close](#)[Full Screen / Esc](#)[Printer-friendly Version](#)[Interactive Discussion](#)

period; consequently the resultant flux estimates are statistically more robust.

The vDEC method has been successfully applied to give VOC flux estimates over vegetation canopies, including grassland (Karl et al., 2001; Ammann et al., 2006; Brunner et al., 2007), forests (Karl et al., 2002; Spirig et al., 2005; Lee et al., 2006), and over an urban environment (Velasco et al., 2005).

In the current study we deployed both the DEC and vDEC techniques for the measurement of a range of VOCs above the city of Manchester (UK). The recorded data were then used to calculate a city-wide emission flux, and in the case of benzene this was compared to the UK National Atmospheric Emission Inventory (NAEI) for Manchester ([http://www.naei.org.uk/datachunk.php?f\\_datachunk\\_id=174](http://www.naei.org.uk/datachunk.php?f_datachunk_id=174)).

The NAEI is compiled using a bottom-up approach, where combinations of reported and estimated emissions across numerous source sectors are used to provide a spatially disaggregated (1×1 km) emission inventory. The uncertainty associated with these estimates is dependant on the ratio of reported to estimated (modelled) data and hence for compounds such as VOCs, where reported emissions are limited and uncertainty levels are high, micrometeorological methods offer a useful alternative.

## 2 Methods

### 2.1 Measurement site and general setup

The work presented here formed part of the UK CityFlux project, which aimed to (i) directly measure pollutant emissions from urban areas, (ii) investigate controls of these emissions, (iii) derive emission factors relative to CO<sub>2</sub> and CO and (iv) study pollutant transformation by comparing fluxes at the plume, street canyon and urban canopy scale. During the summer of 2006, micrometeorological measurements of VOC emissions were made over the city of Manchester, together with measurements of fluxes and concentrations of VOCs, aerosols, O<sub>3</sub>, CO<sub>2</sub> and H<sub>2</sub>O, as well as mobile measurements with a mobile laboratory, measurements in a street canyon, tracer releases and

## Eddy covariance flux measurements of VOC from a city

B. Langford et al.

Title Page

Abstract

Introduction

Conclusions

References

Tables

Figures

◀

▶

◀

▶

Back

Close

Full Screen / Esc

Printer-friendly Version

Interactive Discussion

aircraft-borne measurements. The VOC flux measurements were taken from the roof of Portland Tower (53°28'41" N; 2°14'18" W), an 80 m tall office block, which is located in central Manchester. The building is situated on Portland Street, which is approximately 600 m distance from the Arndale centre, (the city's principal shopping district) 475 m from Piccadilly railway station, (the north-west's busiest station), and 100 m from China Town (a concentrated area of restaurants). The building is surrounded by trafficked streets on three sides and a multi-storey car park on the other.

The roof of Portland Tower is not uniformly flat but has three levels. On the lowest level a small shed was erected which housed the PTR-MS. The second level, 2 m above, contained a utility substation which was used to house the sonic anemometer signal box. The roof of the substation was used as the foundation for a 15 m mast which was fitted with a sonic anemometer (Solent Research R3, Gill Instruments Ltd, Lympington, Hants, UK) and Teflon gas inlet line (1/2" OD). The mast was erected to get above the wake effects generated from both the edges of the building and the inhomogeneous roof surface and increased the effective measurement height to 95 m above street level.

Fluxes were measured between the 5 and 20 June 2006. During the first few days of measurements (5th–10th) a high pressure system was centred over Northern Ireland which dominated the weather during this period, with mostly dry conditions, clear skies and temperatures between 16–30°C. Between the 13th–16th a cold front slowly moved across southern England and during this time temperatures at the measurement tower dropped to a maximum of 24°C and a minimum of 14°C on the 16th. For the later part of the campaign, temperatures slowly increased as a high pressure ridge moved in behind the cold front, increasing the average temperature to 21°C. Throughout the campaign the wind direction shifted between SW and NNE, but also came from the SEE at certain times. The wind speed ranged between 0.4 and 11.2 m s<sup>-1</sup>, with an average of 3.3 m s<sup>-1</sup>

---

**Eddy covariance flux measurements of VOC from a city**B. Langford et al.

---

[Title Page](#)[Abstract](#)[Introduction](#)[Conclusions](#)[References](#)[Tables](#)[Figures](#)[⏪](#)[⏩](#)[◀](#)[▶](#)[Back](#)[Close](#)[Full Screen / Esc](#)[Printer-friendly Version](#)[Interactive Discussion](#)

## 2.2 The proton transfer reaction mass spectrometer (PTR-MS)

A standard PTR-MS instrument (Ionicon Analytik, Austria) was used for the measurement of VOC concentrations as it offered the desired sensitivity and response times required for both flux systems. Detailed descriptions of this instrument can be found elsewhere (Lindinger et al., 1998; Hayward et al., 2003; de Gouw and Warneke, 2007), therefore only a brief account of the instrument setup will be given here.

The PTR-MS was optimised to an E/N ratio of 125 Td and programmed to sequentially scan a suite of six protonated target compounds: methanol ( $m/z$  33), acetaldehyde ( $m/z$  45), acetone ( $m/z$  59), isoprene/furan ( $m/z$  69), benzene ( $m/z$  79) and toluene ( $m/z$  93). In addition to these compounds, the  $\text{H}_3\text{O}^+$  primary ion count and two reagent cluster ions were also recorded at  $m/z$  21,  $m/z$  39 and  $m/z$  55, respectively. A further mass,  $m/z$  25, was used at the start of each measurement cycle as a spacer to ensure the monitored air did not contain residues from the previous sample.

The mass detection system of the PTR-MS can only record VOC (ion counts per second) in atomic mass units (amu); therefore it is difficult to attribute ion counts to individual VOC species. Interference from other ions at amu 33, 45, 79 and 93 has been shown to be insignificant in previous studies (de Gouw et al., 2007), but both acetone and propanal have been detected at amu 59. Although this can generate some uncertainty in the measurement of acetone, the signal of acetone is always dominant in ambient air (Kato et al., 2004), therefore ion counts recorded at  $m/z$  59 were ascribed solely to acetone in the present study. Similarly  $m/z$  69 may be isoprene and/or furan, although the latter is normally present at very low concentrations in ambient air (Christian et al., 2004). Mass  $m/z$  69 was therefore solely attributed to isoprene.

The VOC concentrations were calculated using reaction rate constants ( $k$ ) from Zaho and Zhang (2004) and transmission numbers (the time taken for each mass to traverse the drift tube) calculated using  $t=L/v_d$ , where  $L$  is the length of the drift tube and  $v_d$  is the drift velocity (Lindinger et al., 1998).

### Eddy covariance flux measurements of VOC from a city

B. Langford et al.

Title Page

Abstract

Introduction

Conclusions

References

Tables

Figures

◀

▶

◀

▶

Back

Close

Full Screen / Esc

Printer-friendly Version

Interactive Discussion



## 2.3 Flux measurements

During the campaign, two flux measurement techniques (DEC and vDEC) were employed to measure surface layer fluxes of VOCs from the urban canopy. As both techniques utilised a single PTR-MS instrument to give VOC concentrations, it was not possible to operate the systems simultaneously, and therefore fluxes were measured by the two methods in alternate half hours. A Teflon 3-way solenoid valve (001-0017-900, Parker Hannifin) sat in line and enabled the PTR-MS to switch freely between the two systems. Flux measurements in each mode were averaged over a 25 min period and the remaining 5 min of each half hour were used to scan the entire mass spectrum ( $m/z$  21–146) to give basic ambient concentration information on a wide range of VOCs. Figure 1 shows a typical PTR-MS operating sequence during 1 h of measurements and includes the PTR-MS duty cycles for each flux mode.

### 2.3.1 Virtual disjunct eddy covariance sampling system (vDEC)

During the first period of each hour, the 3-way solenoid valve was triggered to enable the PTR-MS to sub-sample directly from the main sample line in a virtual disjunct eddy covariance mode. The quadrapole was set to scan each mass at a rate of 20 ms, allowing sample air to be purged directly into the instrument without the use of an additional sampling system. The inlet for the sample line was mounted a short distance below the sonic anemometer, as vertical displacement has been shown to result in the smallest flux losses (Kristensen et al., 1997). In order to maintain a turbulent flow through the sample line, and thus avoid dampening of the VOC signal, a flow rate of  $60 \text{ l min}^{-1}$  was used. Upon the completion of each PTR-MS duty cycle, data were exported to a LabVIEW logging programme using the Microsoft Windows “dynamic data exchange” (DDE) protocol, which stored the data alongside those from the sonic anemometer.

## Eddy covariance flux measurements of VOC from a city

B. Langford et al.

Title Page

Abstract

Introduction

Conclusions

References

Tables

Figures

◀

▶

◀

▶

Back

Close

Full Screen / Esc

Printer-friendly Version

Interactive Discussion

### 2.3.2 Disjunct flux sampling system (DFS)

A disjunct flux sampling system was deployed on the roof of the building to monitor the VOC fluxes for the second period of each hour. The schematic and operating sequence of the DFS are depicted in Fig. 2. The sampler comprised two one litre stainless steel canisters, which act as intermediate storage reservoirs (ISR) for sampled air. Fast switching high flow conductance valves (Lucifer E121K45) were mounted to the inlet of each canister, enabling the ISR to take a fast grab sample once activated. Each ISR was coiled with heater cable and insulated with aluminium foil to maintain an internal temperature of 40°C. This, combined with the cylindrical shape of the canisters which reduced surface area, helped to minimise losses of VOC to walls, and minimised condensation and the formation of liquid water, which can remove soluble compounds such as methanol.

Before grab samples of air were taken, each ISR was first evacuated to a pressure of 250 mbar. The time taken to evacuate the canister, 12 s, was the limiting factor in determining the length of time between sampling. By contrast, the time taken to fully pressurise the ISRs, 0.5 s, proved to be the limiting factor in determining sampling times. Therefore the overall effective response time of the DFS setup is about 0.5 s, which is sufficient to resolve turbulent fluctuations of up to 2 Hz.

Grab samples of air acquired by the DFS were analysed for VOCs using the PTR-MS, which was connected to the DFS via a 4 m length of 1/8" PFA tubing. The rate at which the PTR-MS draws air from the ISR is important as a vacuum is gradually generated as air is sampled. This back-pressure can affect the pressure in the drift tube, which can lead to small changes in the  $E/N$  ratio of the instrument. In order to prevent this problem, the flow rate of the PTR-MS was reduced from 300 ml min<sup>-1</sup> to 150 ml min<sup>-1</sup>.

The PTR-MS was housed some distance from the sonic anemometer. Thus the sampling line between ISRs and PTR-MS would have been too long for the DFS to be mounted on the anemometer mast. Instead it was located at the base of the tower,

## Eddy covariance flux measurements of VOC from a city

B. Langford et al.

Title Page

Abstract

Introduction

Conclusions

References

Tables

Figures

◀

▶

◀

▶

Back

Close

Full Screen / Esc

Printer-friendly Version

Interactive Discussion

## Eddy covariance flux measurements of VOC from a city

B. Langford et al.

Title Page

Abstract

Introduction

Conclusions

References

Tables

Figures

◀

▶

◀

▶

Back

Close

Full Screen / Esc

Printer-friendly Version

Interactive Discussion

with each sample valve connected via a “T-piece” into the  $1/2$ ” OD sampling line. As a drawback of this setup, the sample line is subject to a pressure drop of approximately 200 mbar, caused by the high flow rates used. Consequently, upon activation of sample valves each ISR could only pressurise to 800 mbar, increasing their effective carryover between samples from 25% under normal operating conditions (at 1000 mbar) to ~31%. The carryover was corrected using the following equation:

$$\chi_{\text{cor}} = (\chi \times P_1 - \chi_{\text{old}} \times P_2) / (P_1 - P_2) \quad (1)$$

where  $\chi$  is the VOC concentration within the ISR,  $\chi_{\text{old}}$  is the previous concentration of the same ISR,  $P_1$  is the ISR pressure when full and  $P_2$  is the ISR pressure after evacuation.

The sequence of valve switching used to control both the sample and analysis phases of the DFS, which combined with valve switching, pressure recording, sonic anemometer and PTR-MS data recording, were all coordinated using LabVIEW software (National Instruments – v 6.1). The valves were controlled through a multifunction IO card (6071E, National Instruments), which also recorded the analogue signals from the pressure sensors of the ISR (OMEGA, Stamford, Connecticut, PX137-015DV).

### 2.3.3 Flux calculations

In the eddy covariance technique, the flux of an atmospheric scalar is calculated using the covariance between continuous time series of vertical wind speed and scalar concentration at a fixed point in space over a statistically representative time period. Since the data generated by the disjunct flux systems are simply a sub-set of the continuous time series, the flux may be calculated in the same way; thus observations of vertical wind velocity ( $w$ ) were paired with the corresponding PTR-MS data ( $\chi$ ) to give a flux as follows:

$$F \chi_{\text{lag}} = \overline{w' \chi'} \quad (2)$$

where primes indicate instantaneous fluctuations about the mean and over-bars denote time averaging (i.e.  $w' = w - \bar{w}$ ). The only difference between this and direct eddy covariance measurements is the reduced number of data points used for the flux calculation, which results in an increase in the statistical uncertainty of the measurement.

5 Before the flux can be calculated it is first necessary to correct for the time lag that exists between the two data sets, which occurs because of the  $\sim 25$  m separation between the sonic anemometer and the PTR-MS. This time lag was calculated from the maximum value in a cross correlation function between  $w$  and  $\chi$  within a 5 s time window. This value was then used to realign the time series of  $w'$  and  $\chi'$  and calculate the  
10 flux. Typically the peak in the cross correlation was noted between 3 and 5 s, which compared closely with the theoretically calculated lag time of  $\sim 3$  s.

Standard rotations of the coordinate frame were applied to correct for tilting of the sonic anemometer. The vertical rotation angle showed a clear relationship with wind direction, with maximum values of up to  $15^\circ$ . This is similar to other flux measurements in the urban environment (e.g. Nemitz et al., 2002) and suggests that, although  
15 the mean airflow at the anemometer is affected by the building, the influence can be compensated by standard rotational corrections.

Calculated fluxes were subject to a post-processing algorithm which filtered and removed data that failed to meet specified quality controls. These included removal of  
20 large spikes in vertical wind speed or VOC concentration and the omission of data where the average wind speed dropped below  $1 \text{ m s}^{-1}$ . This latter QA procedure resulted in the loss of 7% of the flux data.

In addition, during post-processing of the data, it was found that the inlet pump was occasionally shut down by its thermal trip. The affected time periods were filtered  
25 and the spikes removed, affected averaging periods were not included in the final flux analysis. This meant approximately 31% of measured flux data was deemed unusable and are not shown here.

---

## Eddy covariance flux measurements of VOC from a city

B. Langford et al.

---

[Title Page](#)[Abstract](#)[Introduction](#)[Conclusions](#)[References](#)[Tables](#)[Figures](#)[⏪](#)[⏩](#)[◀](#)[▶](#)[Back](#)[Close](#)[Full Screen / Esc](#)[Printer-friendly Version](#)[Interactive Discussion](#)

### 3 Results and discussion

#### 3.1 VOC concentrations

Concentrations of VOCs are summarised in Table 1 and the 25 min average values are plotted alongside temperature and wind direction in Fig. 3. The oxygenated compounds, methanol, acetone and acetaldehyde, were the most abundant (methanol 1.3–8 ppbv; acetone 0.3–4.4 ppbv; acetaldehyde 0.44–3.2 ppbv). The larger concentrations of methanol compared with the other analytes are typical for urban VOC measurements and can be attributed to its relatively low photochemical reactivity (Atkinson, 2000) and the numerous anthropogenic/biogenic sources which contribute to its emissions both in and outside of the city (de Gouw et al., 2003). Comparisons of methanol concentrations with previous studies shows the values observed here to be within the lower range of concentrations measured in Barcelona (Filella and Penuelas, 2006) and within the range of values recorded in Innsbruck (Holzinger et al., 2001). The concentrations of the other two oxygenated compounds, acetone and acetaldehyde, both lie within the range of data reported from other major conurbations such as Rome (Possanzini et al., 1996), Los Angeles (Grosjean et al., 1996) and Rio de Janeiro (Grosjean et al., 2002).

Concentrations of isoprene ranged between 0.07–0.75 ppbv, which is consistent with values obtained from the national air quality monitoring network ([http://www.airquality.co.uk/archive/reports/cat13/0602011042\\_q3\\_2005\\_rat\\_rep\\_issue1\\_v5.pdf](http://www.airquality.co.uk/archive/reports/cat13/0602011042_q3_2005_rat_rep_issue1_v5.pdf)) for other UK cities, including Bristol and London. The aromatic compounds, benzene and toluene, were the least abundant of the VOCs measured, ranging between 0.02–0.2 and 0.03–0.73 ppbv, respectively. These values also compared well with data obtained from the National network ([www.airquality.co.uk](http://www.airquality.co.uk)) automatic monitoring station on Marylebone Road, London, although, on average, concentrations from the London site were higher, presumably due to the kerbside location of the sampler, compared with a sampling height of 95 m for the concentrations reported here.

Strong linear relationships were observed between the concentrations of each of the measured VOCs, with  $R^2$  values ranging between 0.24 and 0.85, suggesting some

## Eddy covariance flux measurements of VOC from a city

B. Langford et al.

Title Page

Abstract

Introduction

Conclusions

References

Tables

Figures

◀

▶

◀

▶

Back

Close

Full Screen / Esc

Printer-friendly Version

Interactive Discussion

commonality between the sources of emission for each of the compounds.

Clear day-night trends in mixing-ratios were not apparent, with maxima occasionally observed at night time (Thursday 8th, Saturday 11th), whereas on other days (Saturday 17th–Tuesday 20th) they tended to peak during the late afternoon. Spikes were frequently observed in the concentration of methanol during the early morning. This often corresponded to low temperatures and low wind speed in the early morning and is consistent with previous urban VOC studies which have attributed this increase to condensation processes (Fiella and Penuelas, 2006). The nocturnal increase in concentrations for the other compounds is unclear, but is likely a combination of small night-time emissions accumulating in the shallow nocturnal boundary layer, the dynamics of which differed between the different nights. These emissions may include combustion and fugitive emissions from industrial activity outside the flux footprint, on the outskirts of the city.

Additional spikes in VOC concentrations can be observed in Fig. 3. While some of these can be ascribed to changes in wind direction, such as those observed in  $m/z$  59 on the 14th, others, as seen in  $m/z$  93 on the 16th cannot.

Figure 4 shows scatter plots of VOC mixing ratios measured during the vDEC mode between the 5 and 20 June. These plots are useful for the interpretation and source apportionment of data. For example, strong linear relationships, as seen in panel (I), may suggest a similar source contributing to the emission of the two compounds, whereas in panel (K), where a bimodal distribution is evident, it is possible that there are two separate sources contributing to the observed VOC concentrations. Further information can be obtained from these plots by differentiating data points by a  $z$  axis, in this case temperature, which in some instances (panel (E)) can reveal what appears to be a temperature dependency in the measured concentration of the VOC. To help with the further interpretation of the data shown in Fig. 4, Table 2 lists some of the known anthropogenic, biogenic and chemical sources of the measured compounds and also includes atmospheric lifetimes with respect to OH, NO<sub>3</sub>, O<sub>3</sub> and photolysis.

Figure 4, panel (A), shows the correlation between isoprene ( $m/z$  69) and benzene

---

**Eddy covariance flux measurements of VOC from a city**B. Langford et al.

---

[Title Page](#)[Abstract](#)[Introduction](#)[Conclusions](#)[References](#)[Tables](#)[Figures](#)[◀](#)[▶](#)[◀](#)[▶](#)[Back](#)[Close](#)[Full Screen / Esc](#)[Printer-friendly Version](#)[Interactive Discussion](#)

( $m/z$  79). Both these compounds are known constituents of petrol fuel (Borbon et al., 2001), and consequently they are emitted to the atmosphere by the same two anthropogenic sources: direct emissions from vehicle exhausts and evaporative emissions from petroleum products, hence the strong linear relationship ( $R^2=0.87$  ( $p<0.0001$ )) observed between the two compounds during this study. Despite the apparent clarity of this relationship, more detailed analysis of the data with respect to temperature, as shown in Fig. 5, indicates the observed isoprene concentrations to be strongly influenced by the ambient air temperature, with higher concentrations relative to those of benzene observed during warmer conditions. It is reasonable to presume that the composition of vehicle exhaust is unlikely to vary significantly with changes in the observed ambient air temperature (16–30°C), therefore it must be assumed that this increase occurs either due to increased evaporative emissions, as isoprene is more volatile than benzene, or that there are emissions of isoprene from a third source, independent of that of benzene. Biogenic emissions of isoprene are an obvious candidate, as isoprene emission rates from plants have been shown to be both temperature and light dependant (Guenther et al., 1995). Yet, analysis of an isoprene inventory for Great Britain (Stewart et al., 2003) shows few biogenic sources of isoprene within the city centre. Analysis of the meteorology during the period, when the ambient air temperature was at its highest, shows the average wind speed to be approximately 8 m s<sup>-1</sup>. Although isoprene has a short atmospheric lifetime in the daytime, typically on the order of 1 h (Atkinson, 2000), due to reactions with the OH radical, at such wind speeds, air masses containing isoprene emitted from rural areas, outside of the city could have reached the tower before removal by OH. Consequently it is assumed that the temperature-dependent fraction of isoprene observed during this study was a combination of both evaporative and biogenic emissions. The percentage contribution of temperature-dependent isoprene is shown in Fig. 6. This plot suggests that at 30°C as much as 32% of the observed isoprene within the city centre could be due to a combination of evaporative and biogenic emissions. Separation of these two sources to obtain the biogenic fraction is not possible.

**Eddy covariance flux measurements of VOC from a city**

B. Langford et al.

Title Page

Abstract

Introduction

Conclusions

References

Tables

Figures

◀

▶

◀

▶

Back

Close

Full Screen / Esc

Printer-friendly Version

Interactive Discussion

Toluene was the least volatile of the compounds measured during this study and the ratios of its concentration against those of benzene, isoprene, acetone, acetaldehyde and methanol did not vary with temperature (Fig. 4: panels (B), (C), (E), (H) and (K), respectively). However, in each of these plots, bimodal distributions were observed and each of the aforementioned compounds appeared to demonstrate some degree of temperature dependency with respect to toluene, although this varied between compounds. Acetone appearing to be highly temperature dependant, whereas benzene showed only a slight variation with temperature. In the case of benzene, the observed temperature dependence may be coincidental and due to the prevailing wind direction and increased wind speeds which accompanied the elevated temperatures. This point can be highlighted by investigation of the ratio of benzene to toluene concentrations in Fig. 7. As both of these compounds are known to be present in primary vehicle exhaust emissions (Jobson et al., 2005), and have differing atmospheric lifetimes with respect to the OH radical, analysis of the benzene to toluene ratio (B/T) can be used to gauge the age of an air mass (Warneke et al., 2001). Previous studies have shown the B/T ratio in primary exhaust emissions to typically lie in the range of 0.41–0.83 (Heeb et al., 2000), but this ratio increases as toluene reacts with the OH radical faster than benzene and is preferentially removed over time in the atmosphere. In the present study the average B/T ratio was approximately 0.55 (Fig. 7), suggesting the observed concentrations were typically originating from sources close to the measurement site. However, during the period of elevated temperatures (9–12 June), the ratio increased to approximately 0.67, which suggests slightly older, photochemically processed, air was being advected from outside of the city. In the days before this period (6–9 June), the wind direction was from the SW. As the temperatures increased between the 9th and 12th, the wind direction rotated 180° and the air that had left the city in the days previously was transported back across Manchester. The atmospheric lifetime of toluene with respect to OH is approximately 2 days (Atkinson, 2000), which corresponds to an advection distance of ~1300 km under the prevailing average wind speed. Taking this into account, the returning air mass would be depleted in toluene and therefore the

**Eddy covariance flux measurements of VOC from a city**

B. Langford et al.

Title Page

Abstract

Introduction

Conclusions

References

Tables

Figures

◀

▶

◀

▶

Back

Close

Full Screen / Esc

Printer-friendly Version

Interactive Discussion



ratio of benzene to toluene in the air mass would increase, which can be seen occurring in Fig. 7. In addition, the removal rate of toluene may have been increased due to higher concentrations of the OH radical corresponding to the increase in temperature. Therefore it can be concluded that, although some temperature dependency may be observed due to increased evaporative emissions and OH concentrations, the bimodal distributions observed in Fig. 4 panels (B), (C), (E), (H) and (K) are, in part, a result of an older air mass being advected back across the city, in which the toluene has been removed through reaction with the OH radical. Fig. 7 also demonstrates the diurnal cycle in the B/T ratio due to changes of OH concentrations over the day.

Acetone ( $m/z$  59) appeared to show the greatest degree of temperature dependence out of all the measured VOCs. Like acetaldehyde, acetone can be formed in the atmosphere as a product of the photooxidation of hydrocarbons, including propane, isobutene and isopentane (Singh and Zimmerman, 1992). These are primary vehicle exhaust pollutants (Hwa, 2002; Chiang et al., 2007); however, the atmospheric lifetime of each is typically on the order of tens of days, therefore temperature-dependant photooxidation is unlikely to be a major source of acetone within the city. Both acetone and acetaldehyde are themselves found in vehicle exhaust emissions (Sigsby et al., 1987; Caplain et al., 2006), which accounts for the close relationship observed with benzene concentrations. Again, the apparent temperature dependency of these compounds, seen in Fig. 4 panels (D) and (G), could be related to the high volatilities of these compounds, leading to fugitive evaporative emissions at higher temperatures. Although acetaldehyde is more volatile than acetone, and therefore should demonstrate the greatest tendency to evaporate at higher temperatures, acetone has a wider distribution of potential sources as it is not only found in petrol but also in a wide range of solvents and cleaning fluids (Table 2).

### 3.2 VOC fluxes

Averaged diurnal fluxes for the period 5–20 June 2006, as measured by both the DEC and vDEC techniques, are shown in Fig. 8. Despite some variability between the two

## Eddy covariance flux measurements of VOC from a city

B. Langford et al.

Title Page

Abstract

Introduction

Conclusions

References

Tables

Figures

⏪

⏩

◀

▶

Back

Close

Full Screen / Esc

Printer-friendly Version

Interactive Discussion

---

**Eddy covariance flux measurements of VOC from a city**B. Langford et al.

---

[Title Page](#)[Abstract](#)[Introduction](#)[Conclusions](#)[References](#)[Tables](#)[Figures](#)[⏪](#)[⏩](#)[◀](#)[▶](#)[Back](#)[Close](#)[Full Screen / Esc](#)[Printer-friendly Version](#)[Interactive Discussion](#)

systems, both techniques show VOC fluxes to have a clear diurnal trend, with fluxes at their largest in the mid to late afternoon and lowest in the early hours of the morning. On average, fluxes were positive for most of the day, indicating the city to be acting as a net source of VOC to the atmosphere, although deposition was observed for short periods in the night. Typically, emissions rose sharply just after sunrise between 06.00 and 10.00 h, peaking at around midday for most compounds. This morning rise coincided with the peak in traffic counts which were taken on Oxford Road, a busy street adjacent to Portland Street, which provides a good proxy of the relative change of the diurnal traffic pattern in the area.

On average, fluxes of acetone were the largest ( $88 \mu\text{g m}^{-2} \text{h}^{-1}$ ) followed by methanol, ( $79 \mu\text{g m}^{-2} \text{h}^{-1}$ ) and acetaldehyde, ( $60 \mu\text{g m}^{-2} \text{h}^{-1}$ ), whereas fluxes of the aromatic compounds benzene and toluene were lower ( $19 \mu\text{g m}^{-2} \text{h}^{-1}$  and  $42 \mu\text{g m}^{-2} \text{h}^{-1}$ , respectively). Isoprene fluxes were omitted from the final analysis, as significant differences were observed between the two techniques, indicating a possible source of contamination in one or other of the systems.

Panel B, Fig. 9, shows the average daily flux of methanol. Typically, fluxes of methanol started to increase at around 08:00, rising steadily until an early evening maximum between 17:00 and 19:00 h. At this time fluxes dropped off sharply before levelling and reaching a minimum during the early morning.

Panel C shows the flux of acetaldehyde, which tended to have two afternoon maxima, the first and largest at around 13:00 h, and the second coinciding with that of methanol at 19:00 h. Similarly, both benzene (panel E) and toluene (panel F) demonstrated a two peak trend. In the case of benzene, the first peak, which occurred typically around 13:00 h was higher than the second, which occurred at 19:00 h. For toluene the reverse was true, with the second peak, again occurring at 19:00 h, being larger than the first at 11:00 h. Acetone (panel D) did not follow the same pattern of emission; instead, it demonstrated a clear single peak (13:00 h) which was not dissimilar to that of the sensible heat flux shown in panel A. Unlike the other compounds, acetone had no peak at around 19:00 h, which may suggest a shift in emission sources at this time.

---

**Eddy covariance flux measurements of VOC from a city**B. Langford et al.

---

[Title Page](#)[Abstract](#)[Introduction](#)[Conclusions](#)[References](#)[Tables](#)[Figures](#)[⏪](#)[⏩](#)[◀](#)[▶](#)[Back](#)[Close](#)[Full Screen / Esc](#)[Printer-friendly Version](#)[Interactive Discussion](#)

These diurnal trends suggest that toluene, benzene and acetaldehyde are primarily derived from direct traffic emissions as they follow the traffic pattern most closely. Acetone shows a different pattern which may be due to emission from other anthropogenic activities such as solvent use. Methanol emissions are broader over the day, consistent with a large contribution from fugitive sources that are coupled to a combination of temperature and anthropogenic activity.

Despite the indirect nature of this comparison, the two flux measurement systems showed reasonable agreement, with measured fluxes falling within the range of the calculated uncertainty (standard error of hourly fluxes). The highest observed correlations between the DEC and vDEC techniques were observed in the fluxes of toluene and acetone, which had  $R^2$  values of 0.79 ( $p < 0.0001$ ;  $N=48$ ) and 0.72 ( $p < 0.0001$ ), respectively. Methanol ( $R^2=0.2$   $p < 0.0288$ ) and acetaldehyde ( $R^2=0.45$   $p < 0.0003$ ) compared less well, as did benzene ( $R^2=0.36$   $p < 0.0001$ ), which, during the mid to late afternoon showed discrepancies between the two techniques. During this time the DEC system underestimated fluxes measured by the vDEC technique in a trend that was noticeable in all measured fluxes with the exception of methanol.

On average fluxes recorded by the vDEC system were 19% (absolute error) larger than those measured by the DEC system, although this value varied significantly between the individual masses, with no observed underestimation for methanol and approximately 40% underestimation for benzene. The most likely cause of this discrepancy is the difference in the effective response times of the two systems, as the vDEC system was able to resolve turbulent fluctuations of up to 20 Hz as opposed to 2 Hz for the DEC system. The slower sampling resolution of the DEC system meant high frequency flux contributions may have been attenuated and lost and therefore the total flux was underestimated.

The portion of the flux attenuated by the slower measurement resolution can be estimated theoretically using wind and temperature data [20 Hz] to calculate the sensible heat flux. Extracting data points to correspond with the activation of DEC sampling valves generates a disjunct time series which can be compared to the original EC

sensible heat flux. Reducing the effective sampling times of the data from 0.05 s to 0.5 s is achieved by simply extracting ten temperature measurements instead of one and using the average value for the flux calculation. When this technique was applied to the sensible heat data (Fig. 9, panel A), the simulated DEC fluxes typically underestimated the EC fluxes by approximately 8%. This suggests that some of the underestimation observed between the two systems is caused by the slower resolution of the DEC system but not all; therefore there are other sources of error which have yet to be quantified. One possible explanation is that the sampling response of the DFS is <2 Hz, possibly because of adsorption / desorption effects in the ISRs for more “sticky” compounds. In addition, the differences between the two techniques seemed to be inversely proportional to VOC concentrations, hence benzene, which was the least abundant compound measured, demonstrated the largest deviation between the two data sets. This suggests the measurements of benzene were close to the detection limit of the instrument. In future this could be improved by increasing the integration time of the vDEC measurement from a dwell time of 20 ms to 0.1 or 0.2 s.

### 3.3 Comparison of measured benzene fluxes with NAEI estimates

Measured fluxes of benzene were up-scaled and compared against the most recent (2005) emission estimate for Manchester taken from the National Atmospheric Emission Inventory ([http://www.naei.org.uk/datachunk.php?f\\_datachunk\\_id=174](http://www.naei.org.uk/datachunk.php?f_datachunk_id=174)). The flux estimates from the vDEC system were used for the comparison as they did not suffer from the attenuation of high frequency flux contributions. In order to compare the up-scaled fluxes with the inventory it was first necessary to calculate the flux foot print (surface area contributing to the flux) so that the appropriate NAEI grid(s) could be selected for comparison.

Footprints were calculated using a simple parameterisation model developed by Kljun et al. (2004) which was run using typical urban meteorology to give footprints under stable, neutral and convectively unstable atmospheric conditions. This model is designed for dynamically homogenous terrain, therefore its application to the urban

## Eddy covariance flux measurements of VOC from a city

B. Langford et al.

Title Page

Abstract

Introduction

Conclusions

References

Tables

Figures

◀

▶

◀

▶

Back

Close

Full Screen / Esc

Printer-friendly Version

Interactive Discussion

environment is not ideal; however there are few if any operational footprint models designed for this type of environment. Therefore the flux footprints obtained are treated as a first-order estimate only. The following parameters were used in the model: standard deviation of vertical wind velocity  $\sigma_w=0.3 \text{ m s}^{-1}$ ; friction velocity  $u^*=0.3 \text{ m s}^{-1}$ ; measurement height  $z_m=95 \text{ m}$ ; roughness length  $z_0=0.4 \text{ m}$ ; and boundary layer height  $h=250 \text{ m}$  (stable),  $1000 \text{ m}$  (neutral) and  $2000 \text{ m}$  (unstable). The results are shown in Fig. 9 and list the distance at which the maximum contribution to the flux can be expected ( $X_{max}$ ) and the distance at which 80% of the flux is contained ( $X_r$ ).

In order to calculate an emission estimate for the city using these data, it was assumed that the observed average fluxes were representative of the benzene emission rates occurring throughout the year (although the emission rates of benzene are likely to show some seasonal variation, with increased vehicle use during the winter months causing higher direct emissions, this may be balanced by the increased fugitive emissions in the summer months). Therefore the measured average total daily flux of benzene ( $454 \mu\text{g m}^{-2} \text{ d}^{-1}$ ) was extrapolated to give an annual emission estimate of  $0.17 (\pm 0.12) \text{ t km}^{-2} \text{ yr}^{-1}$ . This value is six times lower than that predicted by the NAEI ( $0.98 \text{ t km}^{-2} \text{ yr}^{-1}$ ) for Manchester city centre in 2005.

Since the implementation of both the Geneva VOC (UN ECE, 1991) and the Gothenburg multi-pollutant Protocols (UN ECE, 1999) annual average mean benzene concentrations have declined in the UK at a rate of approximately  $-20\%$  per year (Dollard et al., 2007). This decrease has been brought about largely through the implementation of three way catalysts to control vehicle emissions and the use of canisters to control the evaporative emissions. Taking this decline into consideration and readjusting the 2005 NAEI emission estimate accordingly, a revised emission estimate of  $0.78 \text{ t km}^{-2} \text{ yr}^{-1}$  for 2006 is realised. However this figure is still significantly higher than the measured fluxes. Reasons for this large discrepancy are uncertain, but are likely to involve either poorly characterised VOC sources and/or activity statistics within the NAEI, or a statistically unrepresentative measurement of benzene fluxes by the vDEC technique, or a combination of both.

**Eddy covariance flux measurements of VOC from a city**

B. Langford et al.

Title Page

Abstract

Introduction

Conclusions

References

Tables

Figures

◀

▶

◀

▶

Back

Close

Full Screen / Esc

Printer-friendly Version

Interactive Discussion

---

**Eddy covariance flux  
measurements of  
VOC from a city**B. Langford et al.

---

[Title Page](#)[Abstract](#)[Introduction](#)[Conclusions](#)[References](#)[Tables](#)[Figures](#)[◀](#)[▶](#)[◀](#)[▶](#)[Back](#)[Close](#)[Full Screen / Esc](#)[Printer-friendly Version](#)[Interactive Discussion](#)

Measured flux estimates for the remaining five compounds are shown in Table 3, but the NAEI does not explicitly estimate their emission rates, so further comparisons were not possible. Published VOC fluxes from the urban environment are limited, but fluxes have been measured above Mexico City using a vDEC approach as part of the Mexico City Metropolitan Area 2003 field campaign. Average fluxes of methanol ( $1044 \mu\text{g m}^{-2} \text{h}^{-1}$ ), toluene ( $828 \mu\text{g m}^{-2} \text{h}^{-1}$ ) and acetone ( $396 \mu\text{g m}^{-2} \text{h}^{-1}$ ) were found between four and nineteen times higher than those observed in Manchester. This is unsurprising given the much older vehicle fleet, less dominance of catalytic converters and poorer fuel quality in Mexico City, where vehicle emissions are not regulated by the aforementioned protocols.

#### 4 Conclusions

In the past the virtual and disjunct eddy covariance techniques have been successfully applied to give flux information from a range of vegetation canopies. In the present study we have shown that these techniques can be extended to the urban environment provided a measurement site with suitable elevation above street level can be found. We have also demonstrated the effectiveness and limitations of each approach. The vDEC technique is thought to be more suited for urban flux work due to its relative simplicity and fast response time. However, the DEC technique has also been shown to be effective and, with improvements to the system design, such as increased measurement frequency and tower mounting capabilities, could become an important tool in increasing our understanding of both anthropogenic and biogenic VOC emissions.

Emission estimates derived using flux data from the vDEC technique demonstrate the potential of using VOC flux measurements in determining emission estimates on a city wide scale. Although emission estimates obtained in this study are based on a “snap shot” of the total yearly emission, they demonstrate the potential of the technique, which, if deployed on a longer time scale such as a year could give very detailed information on urban-scale emissions, including both spatial and, more importantly,

temporal trends, which are currently not accounted for in the NAEI emission estimates.

Finally, we have demonstrated that ambient air temperature plays an important role in the relative concentrations of VOCs in urban air. While some compounds are solely governed by their volatility and increased evaporation rates at higher temperatures, others such as isoprene, can also be influenced by increased biogenic emissions occurring both in, and outside of the city.

*Acknowledgements.* We thank Bruntwood Estates Ltd for allowing access to Portland Tower and for the cooperation and support of their staff. The work was funded by the UK Natural Environmental Research Council through the “CityFlux” grant and an NCAS studentship and by the ESF VOCBAS programme. We thank I. Longley (Manchester University) who was responsible for the organisation and logistics of the campaign, G. Phillips (CEH Edinburgh) for his help transporting the instrumentation and M. Possell (Lancaster University) for helpful discussion.

## References

- Ammann, C., Brunner, A., Spirig, C., and Neftel, A.: Technical note: Water vapour concentration and flux measurements with PTR-MS, *Atmos. Chem. Phys.*, 6, 4643–4651, 2006, <http://www.atmos-chem-phys.net/6/4643/2006/>.
- Anderson, L. G., Lanning, J. A., Barrell, R., Miyagishima, J., Jones, R. H., and Wolfe, P.: Sources and sinks of formaldehyde and acetaldehyde: An analysis of Denver’s ambient concentration data, *Atmos. Environ.*, 30, 2113–2123, 1996.
- Atkinson, R.: Atmospheric chemistry of VOC and NO<sub>x</sub>, *Atmos. Environ.*, 34, 2063–2101, 2000.
- Aubinet, M., Chermanne, B., Vandenhaute, M., Longdoz, B., Yernaux, M., and Laitat, E.: Long term carbon dioxide exchange above a mixed forest in the Belgian Ardennes, *Agr. Forest Meteorol.*, 108, 293–315, 2001.
- Borbon, A., Fontaine, H., Veillerot, M., Locoge, N., Galloo, J. C., and Guillermo, R.: An investigation into the traffic-related fraction of isoprene at an urban location, *Atmos. Environ.*, 35, 3749–3760, 2001.
- Bowling, D. R., Turnipseed, A. A., Delany, A. C., Baldocchi, D. D., Greenberg, J. P., and Monson, R. K.: The use of relaxed eddy accumulation to measure biosphere-atmosphere exchange of isoprene and of other biological trace gases, *Oecologia*, 116, 306–315, 1998.

## Eddy covariance flux measurements of VOC from a city

B. Langford et al.

Title Page

Abstract

Introduction

Conclusions

References

Tables

Figures

◀

▶

◀

▶

Back

Close

Full Screen / Esc

Printer-friendly Version

Interactive Discussion

- Brunner, A., Ammann, C., Neftel, A., and Spirig, C.: Methanol exchange between grassland and the atmosphere, *Biogeosciences*, 4, 395–410, 2007, <http://www.biogeosciences.net/4/395/2007/>.
- Businger, J. A. and Oncley, S. P.: Flux measurement with conditional sampling, *J. Atmos. Ocean Tech.*, 7, 349–352, 1990.
- Caplain, I., Cazier, F., Nouali, H., Mercier, A., Dechaux, J. C., Nollet, V., Journard, R., Andre, J. M., and Vidon, R.: Emissions of unregulated pollutants from European gasoline and diesel passenger cars, *Atmos. Environ.*, 40, 5954–5966, 2006.
- Chiang, H. L., Hwu, C. S., Chen, S. Y., Wu, M. C., Ma, S. Y., and Huang, Y. S.: Emission factors and characteristics of criteria pollutants and volatile organic compounds (VOCs) in a freeway tunnel study, *Sci. Total Environ.*, 381, 200–211, 2007.
- Christian, T. J., Kleiss, B., Yokelson, R. J., Holzinger, R., Crutzen, P. J., Hao, W. M., Shirai, T., and Blake, D. R.: Comprehensive laboratory measurements of biomass-burning emissions: 2. First intercomparison of open-path FTIR, PTR-MS, and GC-MS/FID/ECD, *J. Geophys. Res.-Atmos.*, 109, D02311, doi:10.1029/2003JD003874, 2004.
- Ciccioli, P., Brancaleoni, E., Frattoni, M., Marta, S., Brachetti, A., Vitullo, M., Tirone, G., and Valentini, R.: Relaxed eddy accumulation, a new technique for measuring emission and deposition fluxes of volatile organic compounds by capillary gas chromatography and mass spectrometry, *J. Chromatogr. A*, 985, 283–296, 2003.
- de Gouw, J. and Warneke, C.: Measurements of volatile organic compounds in the Earth's atmosphere using proton-transfer-reaction mass spectrometry, *Mass. Spectrom. Rev.*, 26, 223–257, 2007.
- de Gouw, J., Warneke, C., Karl, T., Eerdekens, G., van der Veen, C., and Fall, R.: Sensitivity and specificity of atmospheric trace gas detection by proton-transfer-reaction mass spectrometry, *Int. J. Mass. Spectrom.*, 223, 365–382, 2003.
- de Gouw, J. A., Howard, C. J., Custer, T. G., Baker, B. M., and Fall, R.: Proton-transfer chemical-ionization mass spectrometry allows real-time analysis of volatile organic compounds released from cutting and drying of crops, *Environ. Sci. Technol.*, 34, 2640–2648, 2000.
- Dollard, G. J., Dumitrean, P., Telling, S., Dixon, J., and Derwent, R. G.: Observed trends in ambient concentrations of C-2-C-8 hydrocarbons in the United Kingdom over the period from 1993 to 2004, *Atmos. Environ.*, 41, 2559–2569, 2007.
- Dorsey, J. R., Nemitz, E., Gallagher, M. W., Fowler, D., Williams, P. I., Bower, K. N., and Beswick, K. M.: Direct measurements and parameterisation of aerosol flux, concentration

---

**Eddy covariance flux measurements of VOC from a city**B. Langford et al.

---

Title Page

Abstract

Introduction

Conclusions

References

Tables

Figures

◀

▶

◀

▶

Back

Close

Full Screen / Esc

Printer-friendly Version

Interactive Discussion



- and emission velocity above a city, *Atmos. Environ.*, 36, 791–800, 2002.
- Filella, I. and Penuelas, J.: Daily, weekly, and seasonal time courses of VOC concentrations in a semi-urban area near Barcelona, *Atmos. Environ.*, 40, 7752–7769, 2006.
- Friedrich, R. and Obermeier, A.: *Anthropogenic Emissions of Volatile Organic Compounds, Reactive Hydrocarbons in the Atmosphere*, Hewitt, C. N. Academic Press, California, 1–39, 1999.
- Grabmer, W., Graus, M., Lindinger, C., Wisthaler, A., Rappengluck, B., Steinbrecher, R., and Hansel, A.: Disjunct eddy covariance measurements of monoterpene fluxes from a norway spruce forest using PTR-MS, *International Journal of Mass Spectrometry*, 239, 111–115, 2004.
- Greenberg, J. P., Guenther, A., Harley, P., Otter, L., Veenendaal, E. M., Hewitt, C. N., James, A. E., and Owen, S. M.: Eddy flux and leaf-level measurements of biogenic VOC emissions from mopane woodland of Botswana, *J. Geophys. Res.-Atmos.*, 108(D13), 8466, doi:10.1029/2002JD002317, 2003.
- Grosjean, D., Grosjean, E., and Moreira, L. F. R.: Speciated ambient carbonyls in Rio de Janeiro, Brazil, *Environ. Sci. Technol.*, 36, 1389–1395, 2002.
- Grosjean, E., Grosjean, D., Fraser, M. P., and Cass, G. R.: Air quality model evaluation data for organics .2. C-1-C-14 carbonyls in Los Angeles air, *Environ. Sci. Technol.*, 30, 2687–2703, 1996.
- Guenther, A., Geron, C., Pierce, T., Lamb, B., Harley, P., and Fall, R.: Natural emissions of non-methane volatile organic compounds; carbon monoxide, and oxides of nitrogen from north america, *Atmos. Environ.*, 34, 2205–2230, 2000.
- Guenther, A., Hewitt, C. N., Erickson, D., Fall, R., Geron, C., Graedel, T., Harley, P., Klinger, L., Lerdau, M., McKay, W. A., Pierce, T., Scholes, B., Steinbrecher, R., Tallamraju, R., Taylor, J., and Zimmerman, P.: A global model of natural volatile organic-compound emissions, *J. Geophys. Res.-Atmos.*, 100, 8873–8892, 1995.
- Hayward, S., Hewitt, C. N., Sartin, J. H., and Owen, S. M.: Performance characteristics and applications of a proton transfer reaction-mass spectrometer for measuring volatile organic compounds in ambient air, *Environ. Sci. Technol.*, 36, 1554–1560, 2002.
- Heeb, N. V., Forss, A. M., Bach, C., Reimann, S., Herzog, A., and Jackle, H. W.: A comparison of benzene, toluene and C-2-benzenes mixing ratios in automotive exhaust and in the sub-urban atmosphere during the introduction of catalytic converter technology to the Swiss car fleet, *Atmos. Environ.*, 34, 3103–3116, 2000.

---

**Eddy covariance flux measurements of VOC from a city**B. Langford et al.

---

[Title Page](#)[Abstract](#)[Introduction](#)[Conclusions](#)[References](#)[Tables](#)[Figures](#)[◀](#)[▶](#)[◀](#)[▶](#)[Back](#)[Close](#)[Full Screen / Esc](#)[Printer-friendly Version](#)[Interactive Discussion](#)

- Holzinger, R., Jordan, A., Hansel, A., and Lindinger, W.: Methanol measurements in the lower troposphere near Innsbruck (047°16' N; 011°24' E), Austria, *Atmos. Environ.*, 35, 2525–2532, 2001.
- Hurst, D. F., Griffith, D. W. T., and Cook, G. D.: Trace gas emissions from biomass burning in tropical Australian savannas, *J. Geophys. Res.-Atmos.*, 99, 16 441–16 456, 1994.
- Hwa, M. Y., Hsieh, C. C., Wu, T. C., and Chang, L. F. W.: Real-world vehicle emissions and VOCs profile in the Taipei tunnel located at Taiwan Taipei area, *Atmos. Environ.*, 36, 1993–2002, 2002.
- Jobson, B. T., Alexander, M. L., Maupin, G. D., and Muntean, G. G.: On-line analysis of organic compounds in diesel exhaust using a proton transfer reaction mass spectrometer (PTR-MS), *Int. J. Mass. Spectrom.*, 245, 78–89, 2005.
- Karl, T. G., Spirig, C., Rinne, J., Stroud, C., Prevost, P., Greenberg, J., Fall, R., and Guenther, A.: Virtual disjunct eddy covariance measurements of organic compound fluxes from a subalpine forest using proton transfer reaction mass spectrometry, *Atmos. Chem. Phys.*, 2, 279–291, 2002,  
<http://www.atmos-chem-phys.net/2/279/2002/>.
- Karl, T., Guenther, A., Lindinger, C., Jordan, A., Fall, R., and Lindinger, W.: Eddy covariance measurements of oxygenated volatile organic compound fluxes from crop harvesting using a redesigned proton-transfer-reaction mass spectrometer, *J. Geophys. Res.-Atmos.*, 106, 24 157–24 167, 2001.
- Kato, S., Miyakawa, Y., Kaneko, T., and Kajii, Y.: Urban air measurements using PTR-MS in Tokyo area and comparison with GC-FID measurements, *Int. J. Mass. Spectrom.*, 235, 103–110, 2004.
- Kljun, N., Calanca, P., Rotachhi, M. W., and Schmid, H. P.: A simple parameterisation for flux footprint predictions, *Bound.-Lay. Meteorol.*, 112, 503–523, 2004.
- Kreuzwieser, J., Scheerer, U., and Rennenberg, H.: Metabolic origin of acetaldehyde emitted by Poplar (*Populus tremula* x *P-alba*) trees, *J. Exp. Bot.*, 50, 757–765, 1999.
- Kristensen, L., Mann, J., Oncley, S. P., and Wyngaard, J. C.: How close is close enough when measuring scalar fluxes with displaced sensors?, *J. Atmos. Ocean Tech.*, 14, 814–821, 1997.
- Lee, A., Schade, G. W., Holzinger, R., and Goldstein, A. H.: A comparison of new measurements of total monoterpene flux with improved measurements of speciated monoterpene flux, *Atmos. Chem. Phys.*, 5, 505–513, 2005,

---

**Eddy covariance flux measurements of VOC from a city**B. Langford et al.

---

Title Page

Abstract

Introduction

Conclusions

References

Tables

Figures

◀

▶

◀

▶

Back

Close

Full Screen / Esc

Printer-friendly Version

Interactive Discussion

<http://www.atmos-chem-phys.net/5/505/2005/>.

Lenschow, D. H.: Micrometeorological techniques for measuring biosphere-atmosphere trace gas exchange.[IN] Biogenic Trace Gases: Measuring Emissions from Soil & Water, P. A. Matson, London, Blackwell, 126–163, 1995.

5 Lindinger, W., Hansel, A., and Jordan, A.: Proton-transfer-reaction mass spectrometry (PTR-MS): On-line monitoring of volatile organic compounds at pptv levels, Chem. Soc. Rev., 27, 347–354, 1998.

Lipari, F., Dasch, J. M., and Scruggs, W. F.: Aldehyde emissions from wood-burning fireplaces, Environ. Sci. Technol., 18, 326–330, 1984.

10 Nemitz, E., Hargreaves, K. J., McDonald, A. G., Dorsey, J. R., and Fowler, D.: Meteorological measurements of the urban heat budget and CO<sub>2</sub> emissions on a city scale, Environ. Sci. Technol., 36, 3139–3146, 2002.

Olofsson, M., Ek-Olausson, B., Ljungstrom, E., and Langer, S.: Flux of organic compounds from grass measured by relaxed eddy accumulation technique, J. Environ. Monitor., 5, 963–970, 2003.

15 Possanzini, M., Dipalo, V., Petricca, M., Fratarcangeli, R., and Brocco, D.: Measurements of lower carbonyls in Rome ambient air, Atmos. Environ., 30, 3757–3764, 1996.

Sigsby, J. E., Tejada, S., Ray, W., Lang, J. M., and Duncan, J. W.: Volatile organic-compound emissions from 46 in-use passenger cars, Environ. Sci. Technol., 21, 466–475, 1987.

20 Singh, H. B., Ohara, D., Herlth, D., Sachse, W., Blake, D. R., Bradshaw, J. D., Kanakidou, M., and Crutzen, P. J.: Acetone in the atmosphere - distribution, sources, and sinks, J. Geophys. Res.-Atmos., 99, 1805–1819, 1994.

Spirig, C., Neftel, A., Ammann, C., Dommen, J., Grabmer, W., Thielmann, A., Schaub, A., Beauchamp, J., Wisthaler, A., and Hansel, A.: Eddy covariance flux measurements of biogenic VOCs during Echo 2003 using proton transfer reaction mass spectrometry, Atmos. Chem. Phys., 5, 465–481, 2005,

<http://www.atmos-chem-phys.net/5/465/2005/>.

25 Stewart, H. E., Hewitt, C. N., Bunce, R. G. H., Steinbrecher, R., Smiatek, G., and Schoenemeyer, T.: A highly spatially and temporally resolved inventory for biogenic isoprene and monoterpene emissions: Model description and application to Great Britain, J. Geophys. Res.-Atmos., 108(D20), 4644, doi:10.1029/2002JD002694, 2003.

30 Velasco, E., Lamb, B., Pressley, S., Allwine, E., Westberg, H., Jobson, B. T., Alexander, M., Prazeller, P., Molina, L., and Molina, M.: Flux measurements of volatile organic compounds

---

**Eddy covariance flux  
measurements of  
VOC from a city**

B. Langford et al.

---

Title Page

Abstract

Introduction

Conclusions

References

Tables

Figures

◀

▶

◀

▶

Back

Close

Full Screen / Esc

Printer-friendly Version

Interactive Discussion

from an urban landscape, *Geophys. Res. Lett.*, 32, L20802, doi:10.1029/2005GL023356, 2005.

Warneke, C., van der Veen, C., Luxembourg, S., de Gouw, J. A., and Kok, A.: Measurements of benzene and toluene in ambient air using proton-transfer-reaction mass spectrometry: Calibration, humidity dependence, and field intercomparison, *Int. J. Mass. Spectrom.*, 207, 167–182, 2001.

Warneke, C., Karl, T., Judmaier, H., Hansel, A., Jordan, A., Lindinger, W., and Crutzen, P. J.: Acetone, methanol, and other partially oxidized volatile organic emissions from dead plant matter by abiological processes: Significance for atmospheric HO<sub>x</sub> chemistry, *Global Biogeochem. Cy.*, 13, 9–17, 1999.

UN ECE: Protocol to the 1979 Convention on Long-Range Transboundary Air Pollution Concerning the Control of Emissions of Volatile Organic Compounds on their Transboundary Fluxes. ECE/EB.AIR/30. United Nations Economic Commission for Europe, Geneva, Switzerland, 1991.

UN ECE: Protocol to the 1979 Convention on Long-range Transboundary Air Pollution to Abate Acidification, Eutrophication and Ground-level Ozone. United Nations Economic Commission for Europe, Geneva, Switzerland, 1999.

Zhao, J. and Zhang, R. Y.: Proton transfer reaction rate constants between hydronium ion (H<sub>3</sub>O<sup>+</sup>) and volatile organic compounds, *Atmos. Environ.*, 38, 2177–2185, 2004.

**Eddy covariance flux measurements of VOC from a city**

B. Langford et al.

Title Page

Abstract

Introduction

Conclusions

References

Tables

Figures

◀

▶

◀

▶

Back

Close

Full Screen / Esc

Printer-friendly Version

Interactive Discussion

**Table 1.** Summary of VOC concentration and flux measurements between the 5 and 20 June 2006, in Manchester (U.K).

Concentrations [ppb]	Methanol ( <i>m/z</i> 33)	Acetaldehyde ( <i>m/z</i> 45)	Acetone ( <i>m/z</i> 59)	Isoprene ( <i>m/z</i> 69)	Benzene ( <i>m/z</i> 79)	Toluene ( <i>m/z</i> 93)
Mean	3.10	1.20	1.10	0.30	0.10	0.20
Median	2.92	1.14	1.00	0.29	0.08	0.14
Range						
- 5th	1.77	0.63	0.52	0.13	0.03	0.06
- 95th	5.25	1.83	1.94	0.50	0.14	0.35
SD	1.15	0.41	0.48	0.12	0.04	0.10
Geo SD	1.40	1.40	1.50	1.60	–	1.70
N	354	354	354	353	353	354
Fluxes [ $\mu\text{g m}^{-2} \text{h}^{-1}$ ]						
Mean	78.8	59.6	87.8	–	18.9	42.4
Median	80.3	49.5	63.1	–	16.3	39.2
Range						
- 5th	–143.6	–85.1	–111.7	–	–47.0	–67.3
- 95th	327.8	241.3	356.5	–	89.3	160.6
SD	159.8	105.6	152.1	–	42.8	67.8
N	200	200	195	–	186	200

## Eddy covariance flux measurements of VOC from a city

B. Langford et al.

Title Page

Abstract

Introduction

Conclusions

References

Tables

Figures

◀

▶

◀

▶

Back

Close

Full Screen / Esc

Printer-friendly Version

Interactive Discussion

**Table 2.** List of biogenic, anthropogenic VOC sources, including atmospheric lifetimes with respect to OH, NO<sub>3</sub>, O<sub>3</sub> and photolysis. The temperature dependency (TD) of each source is listed, where 5 stars represent a very high dependency and 1 star a very low dependency.

Sources	Methanol [m/z 33]	TD?	Acetaldehyde [m/z 45]	TD?	Acetone [m/z 59]	TD?	Isoprene [m/z 69]	TD?	Benzene [m/z 79]	TD?	Toluene [m/z 93]	TD?	
Biogenic	Direct emissions from plants:  -Plant defence - Cut and drying of vegetation (Guenther et al., 2000)	*	Biomass burning (Lipari et al., 1984; Hurst et al., 1994).  Direct emissions from plants: - leakage from stomata during oxidation of ethanol (Kreuzwieser et al., 1999). - Leaf decomposition (Fall, 2003; Warneke et al., 1999). -Leaf wounding (de Gouw et al., 2000). -Light dark transition emission (Holzinger et al., 2000; Karl et al., 2002). -Plant defence - Cut and drying of vegetation (Guenther et al., 2000)	**	Wetting of dried leaf litter which has been subjected to high daytime temperatures (Warneke et al., 1999)  -Plant defence - Cut and drying of vegetation (Guenther et al., 2000)	***	Emission from plants	*****	No known sources		No known sources		
Anthropogenic	Primarily used as an industrial solvent – inks, adhesives, dyes, paint and varnish remover.  Ingredient of gasoline where it is used as an antifreeze and octane booster. Likely to become an important source in the future.  Antifreeze.	***	Fossil fuel combustion (Anderson et al., 1996) Tail pipe emissions ~0.5% of carbon is emitted as Acetaldehyde. (Sigstby et al., 1987)	*	Produced in industry for use as a solvent, Tail pipe emissions (Sigstby et al., 1987) estimated total emission ~1% of total pipe total exhaust.  Evaporative Emissions	****	Tail pipe emissions (Borbon et al., 2001) 1.6–15.3 mg km <sup>-1</sup> (Chiang et al., 2007)	*	Tail pipe emissions (Borbon et al., 2001) 5.87–12.2 mg km <sup>-1</sup> (Chiang et al., 2007; Hwa, 2002)	*	Tail pipe emissions (Borbon et al., 2001) 29 mg km <sup>-1</sup> (Chiang et al., 2007; Hwa, 2002)	*	Solvents – cleaning operations Paint thinners  Ink and Paint manufacture Printing and publishing Evaporative emissions – petrol forecourts

† Atmospheric lifetimes of VOCs are taken from Atkinson (2000).

## Eddy covariance flux measurements of VOC from a city

B. Langford et al.

Title Page

Abstract

Introduction

Conclusions

References

Tables

Figures

⏪

⏩

◀

▶

Back

Close

Full Screen / Esc

Printer-friendly Version

Interactive Discussion

## Eddy covariance flux measurements of VOC from a city

B. Langford et al.

Table 2. Continued.

Sources	Methanol [ <i>m/z</i> 33]	TD?	Acetaldehyde [ <i>m/z</i> 45]	TD?	Acetone [ <i>m/z</i> 59]	TD?	Isoprene [ <i>m/z</i> 69]	TD?	Benzene [ <i>m/z</i> 79]	TD?	Toluene [ <i>m/z</i> 93]	TD?
Atmospheric Chemistry			Oxidation of Hydrocarbons (Grosjean et al., 2003)		Oxidation of propane (which has an atmospheric lifetime with respect to OH of 10 days), isobutene and isopentane (Singh et al., 1994)		****					
			>C1 alkanes (e.g. ethane, propane, <i>n</i> -butane) and >C2 alkenes (propene, 2-butene) form acetaldehyde as an intermediate oxidation product.		[Propane 0.2–2.4 mg km <sup>-1</sup> (Hwa, 2002; Chiang et al., 2007), isobutene (5.6 mg km <sup>-1</sup> (Hwa, 2002) and isopentane (40.1 mg km <sup>-1</sup> (Chiang et al., 2007) have all been shown to be emitted in vehicle exhaust.							
Atmospheric lifetime with respect to OH <sup>†</sup>	12 day		8.8 h		53 days		1.4 h		9.4 day		1.9 day	
NO <sub>3</sub> <sup>†</sup>	1 yr		17 day		>11 yr		50 min		>4 years		1.9 yr	
O <sub>3</sub> <sup>†</sup>	–		>4.5 yr		–		1.3 day		>4.5 years		>4.5 yr	
Photolysis <sup>†</sup>	–		6 day		–		–		–		–	
Vapour Pressures at 25 [C]	16.9 [kPa]		98.7 [kPa]		53 [kPa] (15C)		33 [kPa]		12.6 [kPa]		3.73 [kPa]	

<sup>†</sup> Atmospheric lifetimes of VOCs are taken from Atkinson (2000).

Title Page

Abstract

Introduction

Conclusions

References

Tables

Figures

◀

▶

◀

▶

Back

Close

Full Screen / Esc

Printer-friendly Version

Interactive Discussion

## Eddy covariance flux measurements of VOC from a city

B. Langford et al.

**Table 3.** VOC emission estimates for Manchester city centre based on micrometeorological flux measurements from Portland Tower.

	Methanol	Acetaldehyde	Acetone	Benzene	Toluene
Emission Estimate [t km <sup>-2</sup> yr <sup>-1</sup> ]	0.69 (±0.44)	0.52 (±0.29)	0.77 (±0.41)	0.17 (±0.12)	0.37 (±0.18)
NAEI Emission Estimate (2005) [t km <sup>-2</sup> yr <sup>-1</sup> ]	–	–	–	0.98 (±0.02)	–

Title Page

Abstract

Introduction

Conclusions

References

Tables

Figures

◀

▶

◀

▶

Back

Close

Full Screen / Esc

Printer-friendly Version

Interactive Discussion



## Eddy covariance flux measurements of VOC from a city

B. Langford et al.

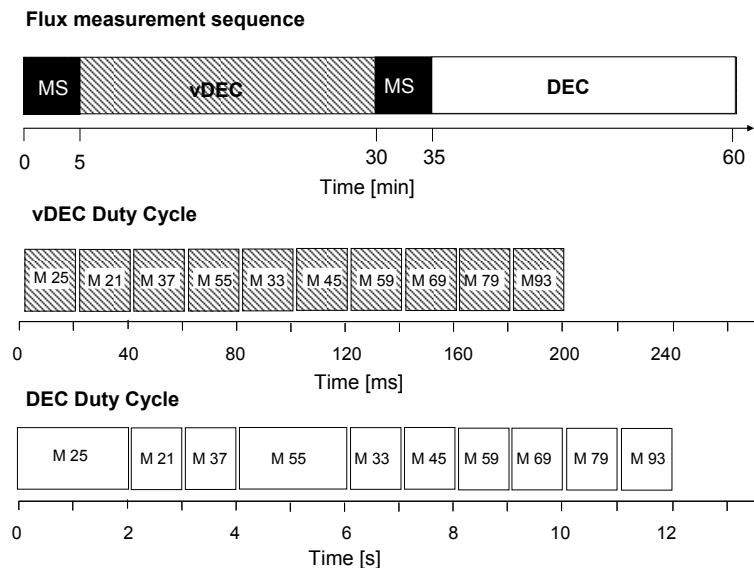
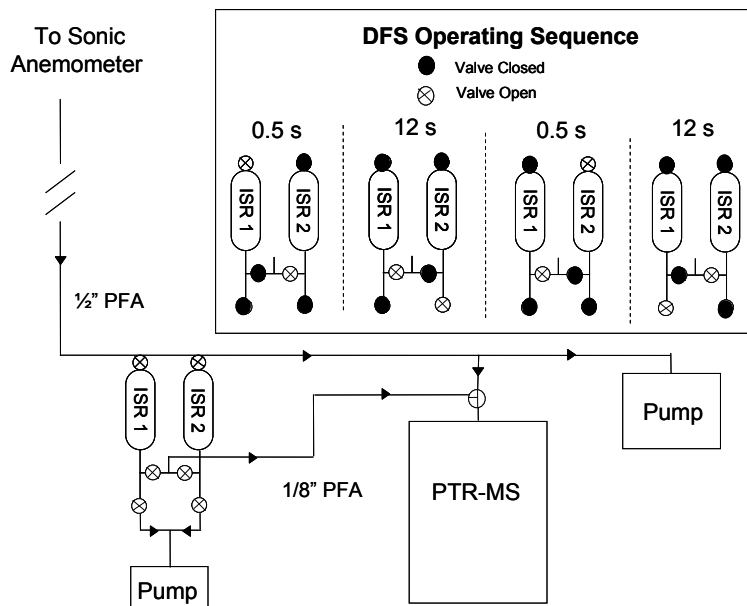

**Fig. 1.** Representation of the PTR-MS measurement sequence used at Portland Tower. When operating in vDEC mode the duty cycle lasted for a total of 200 ms, whereas in DEC mode dwell times were increased and a 12 s duty cycle was used.

[Title Page](#)[Abstract](#)[Introduction](#)[Conclusions](#)[References](#)[Tables](#)[Figures](#)[◀](#)[▶](#)[◀](#)[▶](#)[Back](#)[Close](#)[Full Screen / Esc](#)[Printer-friendly Version](#)[Interactive Discussion](#)

## Eddy covariance flux measurements of VOC from a city

B. Langford et al.



**Fig. 2.** Schematic of the experimental setup used at Portland tower. The inset diagram shows the operating sequence of solenoid valves which controlled the sample and analysis phase of the disjunct flux sampler (DFS). ISR=Intermediate storage reservoir.

Title Page

Abstract

Introduction

Conclusions

References

Tables

Figures

◀

▶

◀

▶

Back

Close

Full Screen / Esc

Printer-friendly Version

Interactive Discussion

## Eddy covariance flux measurements of VOC from a city

B. Langford et al.

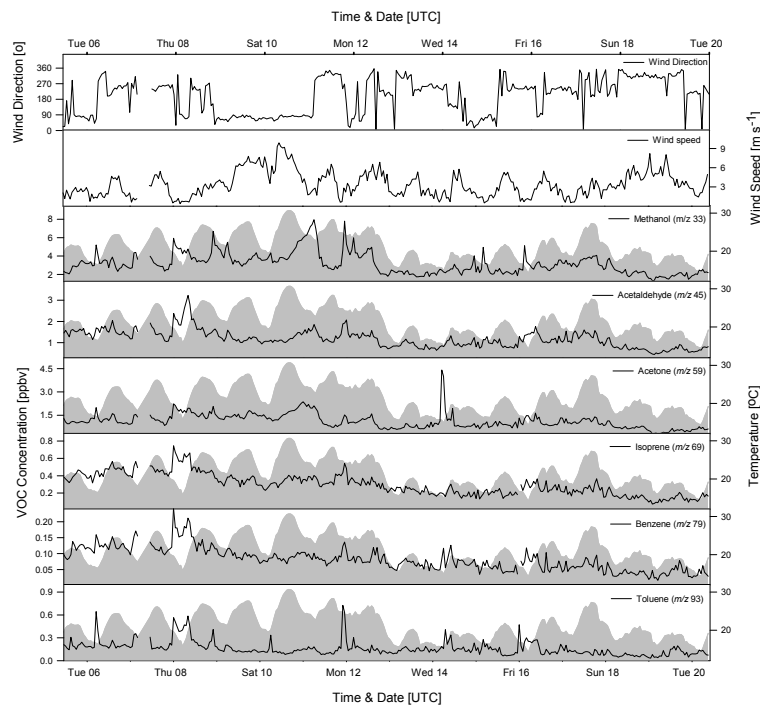

**Fig. 3.** Plot showing 30 min average wind direction and the 25 min average concentrations of VOCs measured by the PTR-MS between 5 and 20 June 2006. Shaded areas represent the 30 min average temperature as recorded by the sonic anemometer.

Title Page

Abstract

Introduction

Conclusions

References

Tables

Figures

◀

▶

◀

▶

Back

Close

Full Screen / Esc

Printer-friendly Version

Interactive Discussion

## Eddy covariance flux measurements of VOC from a city

B. Langford et al.

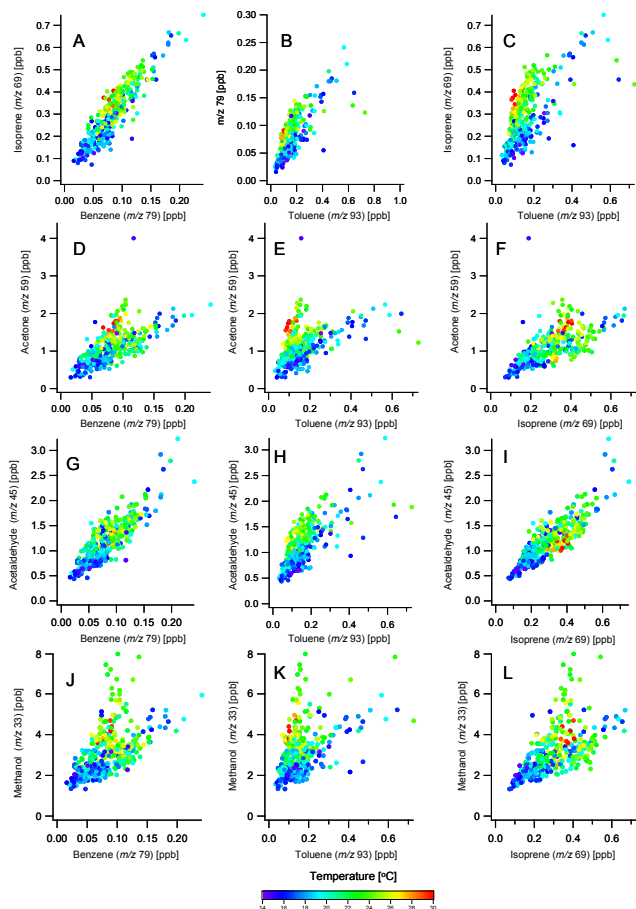
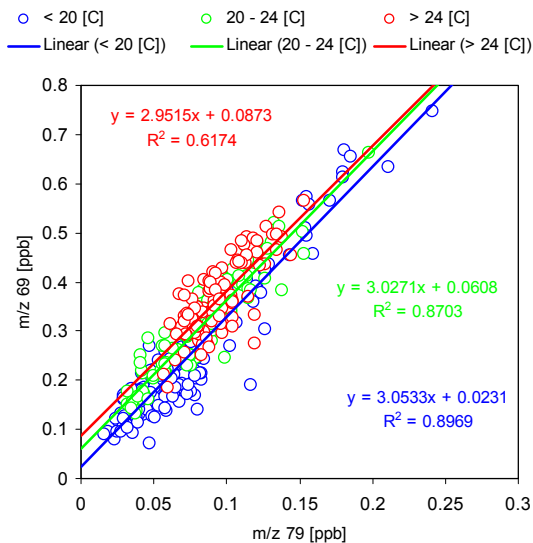

**Fig. 4.** Scatter plots of VOC concentrations measured at Portland Tower, Manchester. Colour bar corresponds to ambient air temperature at the time of sampling.

[Title Page](#)[Abstract](#)[Introduction](#)[Conclusions](#)[References](#)[Tables](#)[Figures](#)[◀](#)[▶](#)[◀](#)[▶](#)[Back](#)[Close](#)[Full Screen / Esc](#)[Printer-friendly Version](#)[Interactive Discussion](#)

**Eddy covariance flux measurements of VOC from a city**

B. Langford et al.

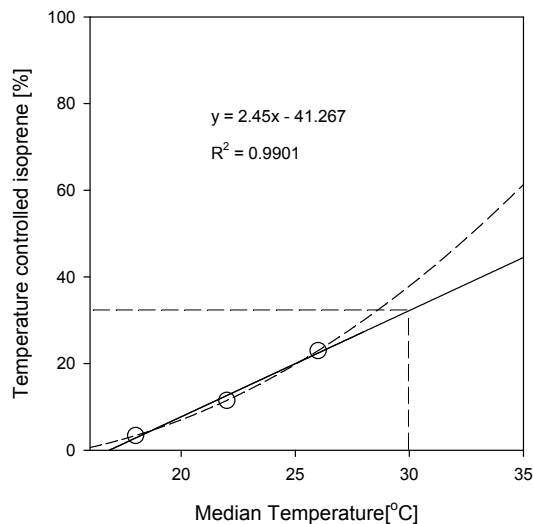

**Fig. 5.** Plot of isoprene concentration ( $m/z$  69) against benzene ( $m/z$  79) at Portland Tower, Manchester. Red circles correspond to data points above 24°C, green circles correspond to data in the range of 20–24°C and blue data points represent data below 20°C.

[Title Page](#)[Abstract](#)[Introduction](#)[Conclusions](#)[References](#)[Tables](#)[Figures](#)[◀](#)[▶](#)[◀](#)[▶](#)[Back](#)[Close](#)[Full Screen / Esc](#)[Printer-friendly Version](#)[Interactive Discussion](#)

**Eddy covariance flux measurements of VOC from a city**

B. Langford et al.

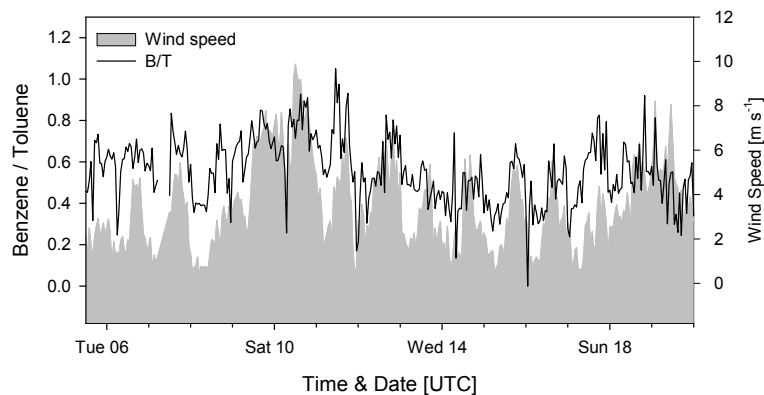

**Fig. 6.** Plot showing the percentage contribution of temperature controlled isoprene at 18, 22 and 26°C. Dashed line indicates the percentage of temperature controlled isoprene that might be expected at 30°C.

[Title Page](#)[Abstract](#)[Introduction](#)[Conclusions](#)[References](#)[Tables](#)[Figures](#)[◀](#)[▶](#)[◀](#)[▶](#)[Back](#)[Close](#)[Full Screen / Esc](#)[Printer-friendly Version](#)[Interactive Discussion](#)

**Eddy covariance flux measurements of VOC from a city**

B. Langford et al.

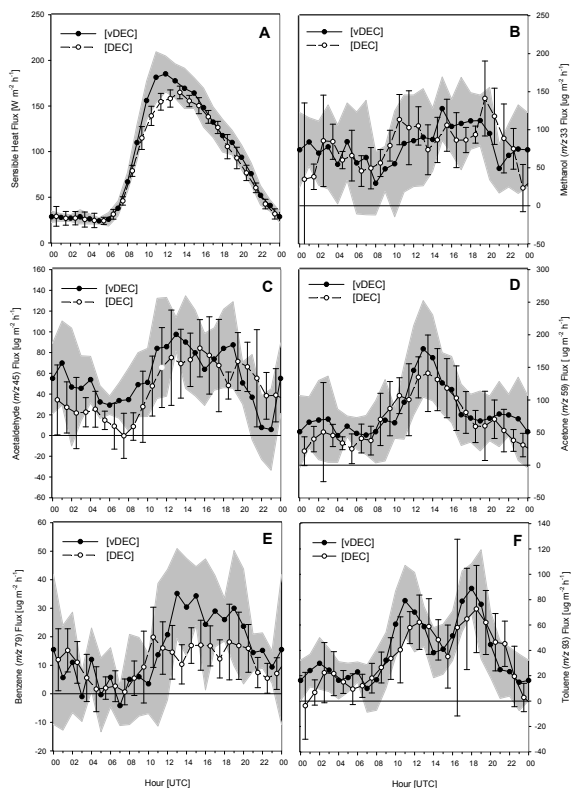

**Fig. 7.** Graph of the ratio of benzene to toluene (solid line) and average wind speed (greyed area).

[Title Page](#)[Abstract](#)[Introduction](#)[Conclusions](#)[References](#)[Tables](#)[Figures](#)[◀](#)[▶](#)[◀](#)[▶](#)[Back](#)[Close](#)[Full Screen / Esc](#)[Printer-friendly Version](#)[Interactive Discussion](#)

## Eddy covariance flux measurements of VOC from a city

B. Langford et al.



**Fig. 8.** Panel A shows the effect of the reduced measurement resolution on simulated disjunct eddy covariance sensible heat fluxes. Panels B–F show the averaged daily fluxes of methanol, acetaldehyde, acetone, benzene and toluene respectively between the 5 and 20 June 2006. Black circles represent measurements from the vDEC system, white circles show DEC measurements, greyed areas represent 1 standard error for the EC fluxes and error bars denoted 1 standard error for DEC fluxes.

Title Page

Abstract

Introduction

Conclusions

References

Tables

Figures

◀

▶

◀

▶

Back

Close

Full Screen / Esc

Printer-friendly Version

Interactive Discussion



## Eddy covariance flux measurements of VOC from a city

B. Langford et al.

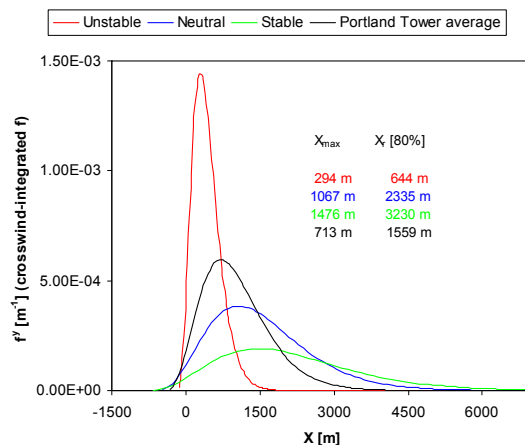

**Fig. 9.** Predicted one-dimensional flux footprint from Portland Tower, Manchester, where the red, blue and green lines represent unstable, neutral and stable atmospheric conditions respectively and the black line indicates the average conditions experienced during the campaign.

Title Page

Abstract

Introduction

Conclusions

References

Tables

Figures

◀

▶

◀

▶

Back

Close

Full Screen / Esc

Printer-friendly Version

Interactive Discussion