



**HAL**  
open science

## A TGA/FT-IR study for OC and EC quantification applied to carbonaceous aerosol collected in Milan (Italy)

P. Fermo, A. Piazzalunga, R. Vecchi, G. Valli, M. Ceriani

► **To cite this version:**

P. Fermo, A. Piazzalunga, R. Vecchi, G. Valli, M. Ceriani. A TGA/FT-IR study for OC and EC quantification applied to carbonaceous aerosol collected in Milan (Italy). *Atmospheric Chemistry and Physics Discussions*, 2005, 5 (4), pp.4335-4371. hal-00301600

**HAL Id: hal-00301600**

**<https://hal.science/hal-00301600>**

Submitted on 18 Jun 2008

**HAL** is a multi-disciplinary open access archive for the deposit and dissemination of scientific research documents, whether they are published or not. The documents may come from teaching and research institutions in France or abroad, or from public or private research centers.

L'archive ouverte pluridisciplinaire **HAL**, est destinée au dépôt et à la diffusion de documents scientifiques de niveau recherche, publiés ou non, émanant des établissements d'enseignement et de recherche français ou étrangers, des laboratoires publics ou privés.

**A TGA/FT-IR study for  
OC and EC  
quantification**

P. Fermo et al.

# **A TGA/FT-IR study for OC and EC quantification applied to carbonaceous aerosol collected in Milan (Italy)**

**P. Fermo<sup>1</sup>, A. Piazzalunga<sup>1</sup>, R. Vecchi<sup>2</sup>, G. Valli<sup>2</sup>, and M. Ceriani<sup>2</sup>**

<sup>1</sup>Dipartimento di Chimica Inorganica, Metallorganica e Analitica, University of Milan, Via Venezian 21, 20133 Milan, Italy

<sup>2</sup>Istituto di Fisica Generale Applicata, University of Milan, via Celoria 16, 20133 Milan, Italy

Received: 7 March 2005 – Accepted: 23 April 2005 – Published: 4 July 2005

Correspondence to: P. Fermo (paola.fermo@unimi.it)

© 2005 Author(s). This work is licensed under a Creative Commons License.

Title Page

Abstract

Introduction

Conclusions

References

Tables

Figures

◀

▶

◀

▶

Back

Close

Full Screen / Esc

Print Version

Interactive Discussion

EGU

## Abstract

Carbon analysis consists in the evaluation of the carbonaceous content of the aerosol (TC) but, more importantly, of its distribution between the two components EC (Elemental Carbon) and OC (Organic Carbon) that are characterized by different physical-chemical properties. In spite of the numerous studies focused on this topic, nowadays, a universal methodology for the determination of the two components EC and OC is not available. In fact OC and EC (also known as black carbon or soot) are operationally defined by the method of analysis and, as a consequence, different methods can produce different results.

In this paper we present results on the application of TGA/FT-IR (Thermogravimetric Analysis/Fourier Transformed Infrared Spectroscopy) to the characterization of carbonaceous aerosols. The analytical methodology was applied to PM10 four-hour time resolution samples collected in Milan urban area. The method is a two-steps thermal one and bases itself on the different thermal behaviour of OC and EC. It has been set up analyzing suitable standards containing both organic and elemental carbon. Carbon quantification is achieved by on-line, continuous monitoring of CO<sub>2</sub> infrared absorption at 2361 cm<sup>-1</sup>. A good separation between OC and EC on particulate matter samples has been obtained. Ranges and average values were respectively 12–70 μg/m<sup>3</sup> and 20 μg/m<sup>3</sup> for OC and 0.2–6 μg/m<sup>3</sup> and 2 μg/m<sup>3</sup> for EC. On average OC and EC made up respectively 29.3 (±12.8) % and 2.5 (±1.8) % of PM10 fraction. The method reliability has been verified by comparison with TOT (Thermal Optical Transmission) technique. OC and EC values determined for ambient samples of PM10 were also correlated with meteorological parameters as well as with Radon concentrations.

## 1. Introduction

The overall composition of the particulate matter (PM) has become one of the fundamental topics in the field of environmental chemistry. One of the main topics is

## A TGA/FT-IR study for OC and EC quantification

P. Fermo et al.

Title Page

Abstract

Introduction

Conclusions

References

Tables

Figures

◀

▶

◀

▶

Back

Close

Full Screen / Esc

Print Version

Interactive Discussion

represented by carbonaceous fraction quantification since this component makes up about the 50% of the particulate mass concentration.

The total carbon content (TC) includes elemental carbon (EC) and organic carbon (OC) as well as a small percentage (less than 5%) of inorganic carbon mainly present as carbonate.

EC is essentially a primary pollutant (Seinfeld and Pandis, 1998) emitted during incomplete combustion of fossil and biomass carbonaceous fuels. In urban area diesel emissions are one of the main sources for black carbon which is often used as an indicator of urban pollution (Delumyea et al., 1980; Salma et al., 2004); furthermore its temporal pattern could be related to traffic intensity (Ruellan and Cachier, 2001).

OC has both primary and secondary origin. Primary OC is mainly formed during combustion processes such as unleaded gasoline combustion in urban area or biomass and field agricultural burning (Duan et al., 2004). It is also directly emitted as plant spores, pollens and soil organic matter. Secondary OC can originate from different processes such as gas to particle conversion of low vapour pressure volatile organic compounds, condensation and physical and chemical adsorption. The presence of secondary organic aerosol (SOA) is suggested by an increasing of OC/EC ratio. Secondary organic aerosol can be easily estimated using EC as tracer of OC primary emission (Turpin and Huntzicker, 1995; Salma et al., 2004). As for OC chemical composition, this fraction contains a large amount of organic substances belonging to different classes (aliphatic or aromatic compounds, acids, etc.) the majority of which has not yet been identified.

EC is also indicated as black carbon (BC) because of its color. It has a graphitic-like structure with the presence of some functional groups containing elements such as oxygen, sulphur, hydrogen and nitrogen, which are able to enhance catalytic processes. EC is also referred as “soot” when carbon to oxygen ratio during the combustion process is less than 1. Indeed, soot, that represents the dark component of the carbonaceous aerosol, is a very complex mixture of both elemental carbon and highly polymerized organic substances.

---

**A TGA/FT-IR study for  
OC and EC  
quantification**P. Fermo et al.

---

[Title Page](#)[Abstract](#)[Introduction](#)[Conclusions](#)[References](#)[Tables](#)[Figures](#)[◀](#)[▶](#)[◀](#)[▶](#)[Back](#)[Close](#)[Full Screen / Esc](#)[Print Version](#)[Interactive Discussion](#)

---

**A TGA/FT-IR study for  
OC and EC  
quantification**P. Fermo et al.

---

[Title Page](#)[Abstract](#)[Introduction](#)[Conclusions](#)[References](#)[Tables](#)[Figures](#)[◀](#)[▶](#)[◀](#)[▶](#)[Back](#)[Close](#)[Full Screen / Esc](#)[Print Version](#)[Interactive Discussion](#)

EGU

The large concern on elemental carbon (EC) concentrations in PM samples is due to the adverse health effects (Summerhays, 1991; Oberdörster and Yu, 1990) and soiling of surfaces. At a global scale, EC might also play a role in radiative forcing effects, as it is the dominant light absorbing component of atmospheric aerosols. As regards to the organic carbon (OC) the increasing awareness has to be attributed to the fact that it typically constitutes up to 70% of the total dry fine particle mass in atmosphere. Moreover, OC is an aggregate of hundreds of individual compounds which can modify the thermodynamic and chemical properties of the atmosphere (Turpin et al., 2000).

The large number of studies carried out in the last years and directed to OC and EC quantification, have demonstrated that, because of the carbonaceous aerosol complex nature, it is difficult to compare results produced by means of different techniques (Schmid et al., 2001; Chow et al., 2001, 2004). In fact these methods gave results in fairly good agreement just with respect to TC concentration while difficulties have been encountered in the determination of the two fractions i.e. EC and OC.

It is worthy to note that up to now a reference method of analysis is not available and there is a significant disagreement in the experimental results (Schmidt et al., 2001).

The methods most commonly applied are based on thermal evolution and reflectance/transmission measurements. Amongst them, the IMPROVE (Chow et al., 1993) and the NIOSH (Birch and Cary, 1996) protocols are widely employed. Both methods involve a first sample (PM deposited on a filter support) heating to 600°C in pure He and, after the temperature has decreased to 400°C, a second heating to 600°C in He containing a small percentage of O<sub>2</sub>. During the first step organic substances are removed since OC is less thermally resistant than EC. However at the same time OC can partially be converted into EC through a pyrolysis. Because of this process, known as “charring”, OC would be underestimated. In order to overcome this problem, a pyrolysis correction is applied monitoring a laser beam transmitted or reflected by the filter. The IMPROVE protocol adopts the thermo-optical reflection (TOR) method while the NIOSH protocol adopts the thermo-optical transmission (TOT) method. The comparison of NIOSH and IMPROVE carbon measurements has shown that they are

---

**A TGA/FT-IR study for  
OC and EC  
quantification**P. Fermo et al.

---

[Title Page](#)[Abstract](#)[Introduction](#)[Conclusions](#)[References](#)[Tables](#)[Figures](#)[◀](#)[▶](#)[◀](#)[▶](#)[Back](#)[Close](#)[Full Screen / Esc](#)[Print Version](#)[Interactive Discussion](#)

EGU

equivalent as concerns TC while NIOSH EC is lower than IMPROVE EC (Chow et al., 2001). The discrepancy is mainly due to differences in the temperature steps and in the correction system. Moreover a recent comparison between TOR and TOT methods has shown that the EC concentration determined by TOT is often a factor two lower than the corresponding value determined by TOR (Chow et al., 2004).

Another well-established thermal method for OC/EC analysis has been proposed by Cachier et al. (1989). In this procedure inorganic carbon is preliminarily eliminated by exposure of the filter to HCl vapours. Afterwards, half a filter is heated at 340°C in oxygen in order to decompose the whole OC. The remaining carbon, i.e. EC, is then determined by coulometric titration. The remaining half of the filter is directly analyzed without the pre-treatment. OC concentration is determined by difference. This protocol is known as LSCE, Laboratoire des Sciences du Climat et de l'Environnement (Cachier et al., 1989).

A thermal method quite similar for some aspects to the LSCE protocol has been proposed in a preliminary work carried out by Fermo et al. (2003). In this study the carbonaceous component in the Milan urban particulate matter was estimated by means of a thermo-gravimetric analyzer combined with an infrared spectrophotometer (TGA/FT-IR). In the present paper the employed technique is the same but the protocol has been partially modified in order to overcome some drawbacks of the previous methodology such as a not satisfactory OC/EC separation and, in some cases, a not sufficient sensitivity.

The aims of this study are:

- to test the reliability of TGA/FT-IR technique for the detection of the carbonaceous component in particulate matter samples;
- to quantify OC and EC concentrations on PM samples collected in Milan (Italy) in a field campaign carried out during winter 2003.

The method set up has involved the analysis of both standard samples prepared in our laboratory and ambient samples of Milan urban particulate matter.

## 2. Experimental

### 2.1. Standards preparation

To optimize and calibrate the analytical methodology applied in this study, some “standard samples” (carbon black or graphite mixed with SiO<sub>2</sub> and some suitable compounds) were generated. These standard mixtures have been prepared so that their carbon concentration, both for organic and elemental carbon was similar to the one expected in the atmospheric aerosol samples.

For this reason, among the organic substances, some of those present in the particulate matter in higher concentration were chosen (Seinfeld and Pandis, 1998).

The following mixtures were prepared:

- *standard a* containing: SiO<sub>2</sub> (80%) and Na<sub>2</sub>C<sub>2</sub>O<sub>4</sub> (20%)
- *standard b* containing: SiO<sub>2</sub> (85%) – palmitic acid (5%) – stearic acid (5%) and benzoic acid (5%)
- *standard c* containing: SiO<sub>2</sub> 70% – Na<sub>2</sub>C<sub>2</sub>O<sub>4</sub> 5% – palmitic acid (5%) – stearic acid (5%) – benzoic acid (5%) – carbon black (10%)
- *standards d1–d3* containing: SiO<sub>2</sub> and graphite in different concentrations, i.e. respectively 4.7%, 1730 ppm and 3300 ppm.

The substances employed for the preparation of the standard samples are commercial products. Graphite powder was obtained grinding E441 Shaped Carbon Rods (Assing, Italy); carbon black was a powder of Monarch (Cabot Corporation, France); silica, sodium oxalate, palmitic acid, stearic acid and benzoic acid were supplied by Aldrich (Italy).

As for the mixtures preparation, the chosen materials were at first mixed in an agate mortar and then in a ball mill (Retsch model S1, operating with three balls 3 mm diameter) in order to obtain a homogeneous sample of powder with small grain dimensions to be deposited on the filter supports.

## A TGA/FT-IR study for OC and EC quantification

P. Fermo et al.

Title Page

Abstract

Introduction

Conclusions

References

Tables

Figures

◀

▶

◀

▶

Back

Close

Full Screen / Esc

Print Version

Interactive Discussion

---

**A TGA/FT-IR study for  
OC and EC  
quantification**P. Fermo et al.

---

[Title Page](#)[Abstract](#)[Introduction](#)[Conclusions](#)[References](#)[Tables](#)[Figures](#)[◀](#)[▶](#)[◀](#)[▶](#)[Back](#)[Close](#)[Full Screen / Esc](#)[Print Version](#)[Interactive Discussion](#)

EGU

The carbon concentration in our standards has been verified by CHN (Carbon/Hydrogen/Nitrogen Analyzer, Perkin Elmer instrument model 2400). In particular as for standards d1–d3, used in the instrument calibration, the actual carbon concentrations were verified by CHN for standard d1 and by TOC (Total Carbon Analyzer, Dohrmann Apollo 9000 instrument equipped with a NDIR-detector and a solid sampler allowing to analyze small sample quantities) for standards d2 and d3. It is worthy to point out that CHN was not suitable to analyze samples d2 and d3 because of their low carbon content. It has been found that the measured carbon concentrations (i.e. those used for the calibration curve, see Sect. 3.2), were slightly lower than those calculated on the base of the weighted quantities, probably because of some losses during mixture preparation.

The NIST (National Institute of Standards and Technology) Standard Reference Material 1649a (urban dust) and the NIES (National Institute for Environmental Studies) Certified Reference Material No. 8 (vehicular exhaust particulate) have been analyzed in order to test the method reliability.

In order to realize measurement conditions quite similar to those typical of particulate matter samples, standard d1 has been deposited on quartz fiber filters and the obtained filters used for the TGA/FT-IR calibration (see further on in the text).

The deposition was done by means of a home-made re-suspension system composed of two differently sized chambers in order to get a homogeneous dispersion of the powder mixture in the chambers' volume. At the inlet of the air flow there is a filter to prevent the entrance of ambient particulate matter in the re-suspension system.

The re-suspended powder was collected on the filter support (quartz fiber filters, Whatman QMA) after passing a size-selective inlet constituted by a cyclone which allowed the sampling of particles with aerodynamic diameter smaller than 3.5  $\mu\text{m}$ . The grains size was checked by scanning electron microscopy (SEM) using a Hitachi 2400 instrument equipped with a Quantum Kevex energy dispersive X-ray microanalyzer (EDX).

Before and after the depositions the quartz fiber filters were exposed for 24–48 h on



open but dust-protected sieve-trays in an air-conditioned weighing room ( $T=20\pm 2^{\circ}\text{C}$  and  $\text{R.H.}=50\pm 5\%$ ). The gravimetric determination of the mass was carried out using an analytical microbalance (precision  $1\ \mu\text{g}$ ), which is installed and operates in the weighing room. In order to remove static electricity from filters the balance was equipped with a special kit consisting in a Faraday shield.

## 2.2. Analytical techniques

### 2.2.1. TGA/FT-IR

EC and OC determination has been performed by a TGA/FT-IR (Thermo-gravimetric Analysis coupled with Fourier Transformed Infrared Spectroscopy) homemade instrument assembled using a JASCO-FTIR spectrophotometer Model 360 and a Dupont Thermo-gravimetric analyzer model 951. A schematic diagram of the carbon analyzer apparatus is reported in Fig. 1.

It consists of a furnace where the sample is heated under controlled conditions and the carbonaceous aerosol fraction is oxidized to  $\text{CO}_2$  whose concentration is monitored by the FT-IR spectrophotometer. Two increasing temperature steps allow the separation of organic carbon from elemental carbon. Dioxide carbon evolved during sample decomposition is transferred through a stainless steel tube heated at  $110^{\circ}\text{C}$  to a 15 cm long multipass White cell equipped with KBr windows (thus the optical path reaches a length of 120 cm) which is located inside the infrared spectrophotometer. In this way, during each thermo-gravimetric analysis, an infrared spectra series is collected automatically by the FT-IR with a spectrum collected every 60 s. By continuous monitoring of  $\text{CO}_2$  absorbance at  $2361\ \text{cm}^{-1}$  (which corresponds to the most intense signal in  $\text{CO}_2$  infrared spectrum) vs. time, a  $\text{CO}_2$  evolution curve (in the following called CEC) is obtained. The curve shows distinctive features and it is possible to distinguish, on the base of the different decomposition temperature, the two components OC and EC detectable as well separated peaks. CECs examples are shown in Fig. 2a–b. These curves were obtained analyzing both standards b and c, prepared as described in the

---

## A TGA/FT-IR study for OC and EC quantification

P. Fermo et al.

---

Title Page

Abstract

Introduction

Conclusions

References

Tables

Figures

◀

▶

◀

▶

Back

Close

Full Screen / Esc

Print Version

Interactive Discussion

---

**A TGA/FT-IR study for  
OC and EC  
quantification**P. Fermo et al.

---

[Title Page](#)[Abstract](#)[Introduction](#)[Conclusions](#)[References](#)[Tables](#)[Figures](#)[◀](#)[▶](#)[◀](#)[▶](#)[Back](#)[Close](#)[Full Screen / Esc](#)[Print Version](#)[Interactive Discussion](#)

EGU

experimental section (Fig. 2a), and a couple of four-hour time resolution particulate matter samples collected in Milan as described further on in the paper (Fig. 2b). Two separated peaks are observable, the first one due to organic carbon and the second one due to elemental carbon. The area under each peak is proportional to the OC and EC content in the sample. It is worthy to note that the small peak corresponding to EC in the CEC of standard b has to be assigned to some organic carbon charring since this standard mixture doesn't contain any elemental carbon. Furthermore, EC peaks fall at higher time values in the real samples since the experimental conditions were slightly different. In fact CECs corresponding to standards b and c were acquired by using the heating program reported for experiment No. 4 (Table 1) while the ambient samples were analyzed as described in experiment No. 5 (Table 1).

All TGA/FT-IR analyses were carried out in O<sub>2</sub> atmosphere with a gas flow rate of 60 ml/min. Before each measurement the White cell was evacuated and purged by a nitrogen flux. Subsequently oxygen was fluxed and the background spectrum acquired. Carbon dioxide is carried through the stainless steel tube and the White cell by means of O<sub>2</sub> flux (Fig. 1).

A two steps heating procedure has been optimized in order to minimize both charring of organic carbon and pre-combustion of elemental carbon. The heating ramp, which allowed to obtain the best separation between EC and OC, consists of a first jump at 435°C, an isotherm for 25 min, a jump at 700°C and an isotherm for 10 min. The heating program is displayed in Fig. 3. Each jump takes about 2 min and 30 s with a heating rate of 160°C/min. Even if the set up temperatures are respectively 435°C and 700°C, actually each jump stops from 5 to 10 degrees in advance; thereafter the system takes 10 min to equilibrate at the two desired temperatures. Each analysis takes altogether 55 min.

The analysis conditions, i.e. the two step temperatures, the atmosphere and the isotherm duration, have been set-up analyzing standard samples (described in Sect. 2.1) and will be discussed later on in this paper.

In order to perform the TGA/FT-IR calibration, known quantities of standards d1–d3

were analyzed.

Thereafter, for each sample, the area of the peak due to elemental carbon was integrated and the obtained values plotted against the corresponding carbon concentrations. The instrument calibration has been carried out analyzing both powders of samples d1–d3 and standard d1 re-suspended on quartz fiber filter (Sect. 3.1).

It is worthy to note that suitable standard carbon concentrations have been selected taking into account the carbon concentrations present both in ambient samples analyzed in this study (see Sect. 3.3) and in SRM1649a. In this way the concentrations determined in the samples fall exactly within the calibration ranges.

For TGA/FT-IR analysis one half of the quartz filter was cut from the exposed filter area or from the standard sample. The filter was then divided into small pieces which were put into a circular shaped and flat platinum sample pan (inner diameter = 1 cm and height = 2 mm) placed in the TGA furnace oven.

### 3. Results and discussion

#### 3.1. Operational conditions set-up

##### 3.1.1. Heating rate and carrier gas

A number of procedures have been recently proposed for OC and EC quantification on filter samples of ambient particulate (Schmid et al., 2001; Chow et al., 2001, 2004, 1993; Birch and Cary, 1996; Cachier et al., 1989; Fermo et al., 2003). Nevertheless, a unique and validated method doesn't exist because of some problems encountered in assigning correctly the carbon content to the organic or to the elemental fraction.

Our methodology for OC and EC analysis is a thermal one based on TGA/FT-IR measurements. It allows OC/EC separation thanks to the different thermal behaviour of the two carbon components. OC and EC are oxidized to carbon dioxide whose quantification is accomplished by a FT-IR spectrophotometer, which acquires infrared

## A TGA/FT-IR study for OC and EC quantification

P. Fermo et al.

Title Page

Abstract

Introduction

Conclusions

References

Tables

Figures

◀

▶

◀

▶

Back

Close

Full Screen / Esc

Print Version

Interactive Discussion

---

**A TGA/FT-IR study for  
OC and EC  
quantification**P. Fermo et al.

---

[Title Page](#)[Abstract](#)[Introduction](#)[Conclusions](#)[References](#)[Tables](#)[Figures](#)[◀](#)[▶](#)[◀](#)[▶](#)[Back](#)[Close](#)[Full Screen / Esc](#)[Print Version](#)[Interactive Discussion](#)

EGU

spectra simultaneously with the thermo-gravimetric analysis. While non-dispersive infrared detection (NDIR) of evolved CO<sub>2</sub> has already been used (Cadle et al., 1980; Tanner et al., 1982; Novakov, 1997), as far as we know, a FT-IR spectrophotometer as a detector is here applied for the first time (see the Experimental section for details on the apparatus).

This system is advantageous since it allows the continuous monitoring of CO<sub>2</sub> as well as other species, such as SO<sub>x</sub>, NO<sub>x</sub> and NH<sub>3</sub> which volatilize during the decomposition of sulphates and nitrates contained in the particulate matter.

Our approach shows some analogies with the earlier thermal methods presented in the literature taking into account the specific problems previously described.

Evolved gas analysis procedures proposed in the literature differ in the temperature programs and in the atmosphere conditions (oxidation or pyrolysis). As concerns the sample heating, up to now three different systems have been employed: (1) direct insertion of the filter into the heated zone (Cadle et al., 1980), (2) flash heating (Tanner et al., 1982; Cachier et al., 1989), i.e. a very rapid heating which allows to reach the final desired temperature within a few minutes, and (3) progressive heating (Chow et al., 1993; Birch and Cary, 1996; Novakov, 1997; Iwatsuki et al., 1998). Since in our system the heating is realized by a thermo-gravimetric analyzer, we have tested both progressive and flash mode. In a previous work (Fermo et al., 2003) first attempts were made using a temperature scanning rate of 5°C/min in the range going from ambient temperature up to 650°C. The method accuracy in total carbon determination was verified analyzing SRM 1649a and the error was within 2%. However, on examining particulate matter on filters, a good separation between OC and EC was not achievable. Therefore, in the present study the heating rate was increased at the maximum value allowed by the instrument (160°C/min) which means to realize a flash heating.

When starting the analysis, at first the system is left to equilibrate for some minutes at 30°C (Fig. 3), than a first jump at 425°C (at a rate of 160°C/min) takes place. At this point, after an isotherm step of 25 min, a second jump at 700°C is performed maintaining the same heating rate (heating temperature values and isotherms duration

are discussed in the next paragraph).

A very rapid heating allowed us to obtain two well distinguishable peaks in the CEC (CO<sub>2</sub> Evolution Curve). Furthermore, in these conditions the determination of low quantity of organic and elemental carbon is possible and the organic carbon volatilization is favoured against carbonization. In fact it is well known that, while heating, organic carbon could char, i.e. a pyrolytic organic-to-elemental carbon conversion takes place. Previous works (Cadle et al., 1980; Cachier et al., 1989) have also estimated the percentage of OC to EC conversion, which is in the worst case about 10–20%.

In the literature as carrier gas, He and a mixture of 10% O<sub>2</sub>/He or 2% O<sub>2</sub>/He are generally used for OC and EC decomposition step respectively (Chow et al., 1993; Birch and Cary 1996; Cadle et al., 1980; Tanner et al., 1982). When an inert atmosphere is used during the first step just the organic fraction decomposition takes place and EC decomposition is prevented. However some authors observed that, in order to minimize charring, oxygen has to be chosen instead of an inert atmosphere (Cachier et al., 1989; Ohta and Okita, 1984). In particular Cachier et al. (1989) found that using both flash heating and oxygen as carrier gas, pyrolysis would affect 10% or less of the initial organic carbon. On the base of some experiments previously carried out by TGA/FT-IR (Fermo et al., 2003) it has been concluded that also in our case charring was more pronounced in non-oxidizing media such as helium. For this reason we selected pure oxygen as carrier gas.

### 3.1.2. Heating temperature and isotherm duration

Once flash heating mode has been selected, some experiments were carried out to optimize the two heating step temperatures in order to find the splitting point between OC and EC, which is not arbitrary. Nevertheless, it is important to stress that up to now the OC and EC definition is an operative one, depending on the analytical method used for their quantification and, as a consequence (see the introduction), this can yield different sharing between the two fractions.

Different temperatures have been proposed in the literature for the separation of

---

## A TGA/FT-IR study for OC and EC quantification

P. Fermo et al.

---

Title Page

Abstract

Introduction

Conclusions

References

Tables

Figures

◀

▶

◀

▶

Back

Close

Full Screen / Esc

Print Version

Interactive Discussion

---

**A TGA/FT-IR study for  
OC and EC  
quantification**P. Fermo et al.

---

[Title Page](#)[Abstract](#)[Introduction](#)[Conclusions](#)[References](#)[Tables](#)[Figures](#)[◀](#)[▶](#)[◀](#)[▶](#)[Back](#)[Close](#)[Full Screen / Esc](#)[Print Version](#)[Interactive Discussion](#)

EGU

organic carbon from elemental carbon such as 300°C–350°C (Cachier et al., 1989; Ohta and Okita, 1984; Ellis et al., 1884), 400°C–430°C (Tanner et al., 1982; Iwatsuki et al., 1998) and 650°C (Cadle et al., 1980).

Isotherm duration is also quite variable and goes from a few minutes (Tanner et al., 1982) to longer periods such as 30 min (Novakov, 1997) 60 min (Iwatsuki et al., 1998) or 120 min (Cachier et al., 1989).

In setting the proper temperature it is mandatory taking into account some facts: temperature must be high enough to assure organic matter complete decomposition; charring must be minimized; elemental carbon pre-combustion must be avoided.

Some experiments were carried out on standard mixtures of known composition in order to establish the optimal temperature for the first step and the corresponding isothermal duration. We didn't check 650°C since the apparatus used in that case (Cadle et al., 1980) worked in an inert atmosphere which allow to avoid EC decomposition while we had decided to work in oxygen (see Sect. 3.1.1).

The second temperature step has been in any case set at 700°C since, working in oxidizing conditions, it is enough to decompose elemental carbon (Cadle et al., 1980; Iwatsuki et al., 1998). This has been verified by our system analyzing both pure graphite and the standard d1–d3. No residual carbon was observed.

Results obtained in the optimization procedure are summarized in Table 1. Each experiment was replicated at least twice.

At first we reproduced the experimental conditions reported by Cachier et al. (1989), i.e. first step temperature of 350°C and a heating duration of 120 min in order to decompose all the OC fraction (experiment No. 1, Table 1). The CEC corresponding to this experiment is reported in Fig. 4, curve a. Only 72% of the total carbon, present in the mixture as Na<sub>2</sub>C<sub>2</sub>O<sub>4</sub>, is recovered in the first step (Table 1). The remaining portion decomposes during the second step but this is due to incomplete oxalate decomposition rather than to charring. In fact, pure sodium oxalate shows two characteristic weight losses respectively at about 500°C and 780°C: at 500°C it decomposes and turns to carbonate which than decomposes at 780°C. The second peak present in the

---

**A TGA/FT-IR study for  
OC and EC  
quantification**P. Fermo et al.

---

[Title Page](#)[Abstract](#)[Introduction](#)[Conclusions](#)[References](#)[Tables](#)[Figures](#)[◀](#)[▶](#)[◀](#)[▶](#)[Back](#)[Close](#)[Full Screen / Esc](#)[Print Version](#)[Interactive Discussion](#)

EGU

CEC is due to the initial carbonate decomposition. Oxalate is the most abundant of the dicarboxylic acids present in the particulate matter and can potentially act as cloud condensation nuclei. Its atmospheric concentration is about  $0.35 \mu\text{g}/\text{m}^3$  (Yao et al., 2002) and together with malonate and succinate represent on average 5.5% of sulphate concentration, one of the main PM component. It has also been demonstrated that mono and di-carboxylic acids represent one of the main classes in the so-called WSOC (water soluble organic carbon) fraction that accounts for about 50% of OC (Decesari et al., 2001). As a consequence, oxalate contribution to particulate matter mass is not negligible. It is important to observe that by thermal methods, such as TGA/FT-IR, OC is slightly underestimated if oxalate is present since it does not completely decompose.

It is also important taking into account that the OC fraction could include high molecular weight organic substances having a thermal behaviour quite similar to that of soot. For example a mixture of amid, starch and sucrose has been chosen as a model for this fraction (Iwatsuki et al., 1998) and its thermal behaviour studied. It has been found that in order to have a complete combustion of this class of substances, it is necessary to reach a threshold temperature of  $485^\circ\text{C}$ .

In our experiment, the first temperature step was then increased to  $425^\circ\text{C}$  in order to test an intermediate value between  $350$  and  $485^\circ\text{C}$  (experiment No. 2, Table 1). The duration step was drastically reduced to 10 min, which seems enough to regain the initial baseline signal and a recovery increase was observed (Fig. 4, curve b).

A temperature of  $350^\circ\text{C}$  is not enough to decompose standard b, a mixture containing organic acids (experiment No. 3, Table 1). Carbon recovery reaches 90% when heating at  $425^\circ\text{C}$  (experiment No. 4, Table 1). Taking into account the decomposition temperatures of the substances contained in standard b it is reasonable supposing that under these conditions a charring of 10% took place.

The temperature of  $425^\circ\text{C}$  was then checked in the analysis of samples of ambient particulate matter. For this purpose a 24-h filter was divided into two portions which were heated at  $425^\circ\text{C}$  with an isotherm duration of 25 min after which the baseline signal was regained (Fig. 5, curves a and b). After cooling, one half of the filter was



---

**A TGA/FT-IR study for  
OC and EC  
quantification**P. Fermo et al.

---

[Title Page](#)[Abstract](#)[Introduction](#)[Conclusions](#)[References](#)[Tables](#)[Figures](#)[◀](#)[▶](#)[◀](#)[▶](#)[Back](#)[Close](#)[Full Screen / Esc](#)[Print Version](#)[Interactive Discussion](#)

EGU

undergone to a 24 h Soxhlet extraction in  $\text{CH}_2\text{Cl}_2$  in order to dissolve the organic matter that was eventually still present. Soxhlet extraction is frequently used in the analysis of particulate matter organic compounds while dichloromethane has been chosen since it is one of the most widely used solvent (Pozzoli et al., 2004). The two halves were then submitted to the complete ramp program (heating at  $425^\circ\text{C}$ /isotherm/heating at  $700^\circ\text{C}$ /isotherm). As it can be observed a residual signal is present in both CECs in correspondence of the first step (Fig. 5, curves c and d) suggesting that also by means of the extraction it was not possible to eliminate all the organic substances (the second peak in both curves c and d is due to EC). The experiment was then carried out working at a  $435^\circ\text{C}$ , which turned out to be high enough to decompose the entire OC fraction. As a consequence, we selected this value as the first step temperature and adopted the first isotherm duration of 25 min for ambient particulate samples analysis.

Some experiments were also performed in order to evaluate minimum EC combustion temperature. According to data reported by other authors (Iwatsuki et al., 1998) in oxidizing conditions the elemental carbon combustion starts beyond  $485^\circ\text{C}$  and it is complete under  $650\text{--}660^\circ\text{C}$  (Cadle et al., 1980; Iwatsuki et al., 1998). Loss of elemental carbon is also reduced by a short pre-combustion step (Cachier et al., 1989). Samples of pure graphite were analyzed by TGA/FT-IR using the following first step temperature:  $425^\circ\text{C}$ ,  $450^\circ\text{C}$ ,  $470^\circ\text{C}$  and  $500^\circ\text{C}$ . Starting from  $470^\circ\text{C}$ , CEC shows a signal in correspondence of the first step indicating that in our operational conditions some EC pre-combustion can take place.

However, it is known that soot present in the atmospheric aerosol is not primarily composed by elemental carbon but contains a variety of highly condensed organic compounds (Cadle et al., 1980; Cachier et al., 1989). Standard reference material NIES No. 8, being a vehicle exhaust particulate, contains about 80% of carbon so that it was used to check pre-combustion conditions in real particulate samples. Four standard samples, previously submitted to Soxhlet extraction in order to eliminate the soluble organic fraction, were analyzed by TGA/FT-IR testing the following first step temperature:  $425^\circ\text{C}$ ,  $435^\circ\text{C}$ ,  $450^\circ\text{C}$  and  $470^\circ\text{C}$ . A signal attributed to pre-combustion



---

**A TGA/FT-IR study for  
OC and EC  
quantification**P. Fermo et al.

---

[Title Page](#)[Abstract](#)[Introduction](#)[Conclusions](#)[References](#)[Tables](#)[Figures](#)[◀](#)[▶](#)[◀](#)[▶](#)[Back](#)[Close](#)[Full Screen / Esc](#)[Print Version](#)[Interactive Discussion](#)

EGU

already appeared at 450°C. We can therefore conclude that to avoid elemental carbon pre-combustion, in our operational condition the maximum allowed temperature for the first step is 435°C. Even if it cannot be excluded that some quite refractory organic substance could be not still decomposed at this temperature, 435°C is a good compromise between the necessity to decompose OC and to avoid EC pre-combustion.

As carbon loss is associated with a change in the filter color, in order to verify if some variation occurred, a particulate matter filter was extracted from the furnace at the end of first isotherm step and no change in the filter color was evident.

The final selected operational conditions for ambient samples analysis are summarized in Table 1.

It is worthy to note that also with our method OC charring cannot be excluded when analyzing particulate matter samples. However for a standard mixture of known composition (standard b, experiment No. 6, Table 1) where no elemental carbon was present, it was estimated to be 10% in accordance with literature data (Cachier et al., 1989). Pure substances with high molecular weights such as sucrose and starch have been also analyzed and, on the base of the ratio between areas of the first and the second peak, it was estimated a charring percentage of 10 and 14%, respectively.

SRM1649a has been also analyzed using the final selected operational conditions. In Fig. 6 are shown the CECs obtained with a first temperature step respectively of 350°C (curve a) and 435°C (curve b). As expected 350°C wasn't high enough to allow complete OC evolution. On the contrary using a first temperature step of 435°C a good agreement with literature values has been obtained (Currie et al., 2002). In particular a total carbon content of 17.0% has been obtained with a certified value of 17.68 (±0.19) % while OC and EC concentrations were respectively 81.4% and 18.6% of TC which are within the range of variation determined by the other methods (Currie et al., 2002).

### 3.2. Calibration and method validation

Some reference samples containing pure graphite and SiO<sub>2</sub> in known quantities have been prepared in order to perform instrument calibration (standard d1-d3 whose com-

position is described Sect. 2.1).

It is important to stress that carbon concentration present in standards d1–d3 are found in ambient samples such those collected in this study, i.e. filters with four-hour time resolution. These filters are characterized by low carbon concentrations and the total carbon quantity present on  $\frac{1}{2}$  filter (that is the analyzed portion) are within the concentration range reported in Tables 2 and 3.

The measurements conditions were the same employed for real samples analysis (experiment No. 5, Table 1) that allowed to obtain the best OC/EC separation. Two different calibration curves were constructed:

- the first curve (Fig. 7a) obtained analyzing different quantities of standard d1, d2 and d3 (Table 2) that can be used for OC/EC quantification when particulate matter powder samples have to be analyzed, e.a. 1649a;
- the second curve (Fig. 7b) obtained analyzing one half filter loaded with standard d1 in different quantities (Table 3) varying between about 0.17 mg and 1.8 mg; this curve is used for OC/EC quantification in real particulate matter samples.

A few PM10, PM2.5 and PM1 samples (Table 4) were also analysed by a thermal-optical method TOT (Sunset Lab. inc., USA) to perform a first comparison with TGA results on EC/OC/TC. The EC/OC instrument at Sunset Lab was designed to specifically address some of the problems observed in other methods in assigning carbon either to the organic or elemental fraction. By the continuous monitoring of the optical absorbance of the sample during the analysis, this method is able to both prevent any undesired oxidation of original elemental carbon and make corrections for the possible generation of carbon char produced by the pyrolytic conversion of organics into elemental carbon.

In Figs. 8a and b preliminary results of the comparison between the TGA/FT-IR and TOT methodologies are shown. Generally there is a good agreement (differences on average lower than 15%) on total carbon while the separation in EC and OC compo-

**A TGA/FT-IR study for  
OC and EC  
quantification**

P. Fermo et al.

Title Page

Abstract

Introduction

Conclusions

References

Tables

Figures

◀

▶

◀

▶

Back

Close

Full Screen / Esc

Print Version

Interactive Discussion

nents shows larger discrepancies probably due to OC charring processes as well as to the EC pre-combustion with TGA/FT-IR method.

### 3.3. Analysis of carbon content in PM samples

The analytical methodology above described was applied to PM10 samples collected in the urban area of Milan to determine the EC/OC/TC content. Blank filters were also analyzed and no significant signals were observed.

The sampling site was a “background urban” location, according to the Italian Environmental Agency definitions, as it is not directly influenced by local emissions (i.e. traffic). The campaign was carried out in 2003, 27 January–10 February, and the PM10 was sampled daily with a four-hour time resolution. As a consequence during each day six four-hour time resolution filters were collected with a total number of 90 (=6×15) ambient samples during the whole period.

During the second week of the campaign the PM threshold values were exceeded so that the local authorities decided to introduce the condition of an odd/even plates traffic. However, this obligation was maintained only for a couple of days (starting from Monday, 3 February) because of the occurrence of a strong Föhn episode, which cleaned up the atmosphere on the whole Po valley (see Fig. 9). Thus, it was not possible to observe the effect of this measure to prevent high pollution levels.

The samples were collected on quartz fiber filters (Whatman QMA) using low volume CEN-equivalent samplers (flow rate: 2.3 m<sup>3</sup>/h) equipped with PM10 (particulate matter with aerodynamic diameter smaller than 10 μm) inlets. The PM10 was gravimetrically determined using the same methodology described in Sect. 2.1.

In Fig. 9 the temporal patterns of PM10, OC and EC concentrations are displayed together with the wind speed registered during the whole campaign. The good correlation between the particulate mass and its carbonaceous component is a first qualitative evidence of TGA/FT-IR reliability. As the examined filters are characterized by a sampling time of 4 h, the particulate matter amount collected is sometimes very low and EC is often below the detection limit (missing values in the figure).

---

## A TGA/FT-IR study for OC and EC quantification

P. Fermo et al.

---

Title Page

Abstract

Introduction

Conclusions

References

Tables

Figures

◀

▶

◀

▶

Back

Close

Full Screen / Esc

Print Version

Interactive Discussion

---

**A TGA/FT-IR study for  
OC and EC  
quantification**

---

P. Fermo et al.

[Title Page](#)[Abstract](#)[Introduction](#)[Conclusions](#)[References](#)[Tables](#)[Figures](#)[◀](#)[▶](#)[◀](#)[▶](#)[Back](#)[Close](#)[Full Screen / Esc](#)[Print Version](#)[Interactive Discussion](#)

EGU

During the measurement period PM mass varied from  $20.1 \mu\text{g}/\text{m}^3$  to  $200.0 \mu\text{g}/\text{m}^3$  with an average value of  $79 \pm 48 \mu\text{g}/\text{m}^3$  (the standard deviation is an expression of the observed variability and not of the experimental error which is lower than 5%).

Ranges and average values were respectively  $12\text{--}70 \mu\text{g}/\text{m}^3$  and  $20 \mu\text{g}/\text{m}^3$  for OC and  $0.2\text{--}6 \mu\text{g}/\text{m}^3$  and  $2 \mu\text{g}/\text{m}^3$  for EC. On average OC and EC made up respectively 29.3 ( $\pm 12.8$ ) % and 2.5 ( $\pm 1.8$ ) % of PM10 mass.

Converting the organic carbon (OC) concentrations to organic matter (OM) concentrations using a mean molecular-to-carbon ratio of 1.6, as proposed by the recent literature (Salma et al., 2004; Turpin and Lim, 2001), an average contribution of about 53% to the PM10 mass has been found.

To study the observed temporal patterns the concentrations of the major gaseous precursors of secondary aerosol as well as meteorological parameters (data available from the regional air quality network) have been also taken into account. For the important role played by the dispersion conditions of the atmosphere in determining PM10 concentration levels in the urban area of Milan, and in general in the whole Po valley, also Radon measurements were carried out during the campaign (Fig. 10). Radon can be considered a good natural tracer of vertical dispersion as it does not undergo chemical transformations in the air and it has a half-life of 3.8 days that is long enough to measure the atmospheric phenomena of interest here. It also has an approximately constant rate of exhalation from the ground over large, homogeneous areas and over time.

The Radon hourly concentration is routinely and continuously measured at ground level (6 m a.s.l.) in Milan by the group of the Institute of Physics. Radon activity concentration outdoor is detected with hourly resolution through the collection of its short-lived decay products attached to aerosol particles and the spectroscopic evaluation of their alpha activity (estimated detection limit =  $0.2 \text{ Bq m}^{-3}$ ). Details on the experimental methodology to measure  $^{222}\text{Rn}$  concentration are reported in Sesana et al. (2003).

The temporal patterns of PM10, OC and  $^{222}\text{Rn}$  show a fairly good correlation (Fig. 10) In particular when radon concentration reaches the maximum values (dur-

ing the night and the early morning) the atmospheric dilution power is poorer and the pollutants accumulate (Vecchi et al., 2004).

#### 4. Conclusions

The method presented appears suitable for the analysis of atmospheric aerosol carbonaceous fraction. It is based on evolved gas analysis and it consists of a simple “home made” apparatus obtained by the coupling between a thermo-gravimetric analyzer and a FT-IR spectrophotometer. In the framework of our study particular attention has been put to the method set-up. In particular it is well known that the choice of both heating program and carrier gas are tricky points in the analysis of the two components OC and EC. The adopted analytical conditions led to the minimization of both charring of OC and pre-combustion of EC.

The method capability to differentiate between OC and EC is supported by the good agreement with TOT technique, which is one of the most widely used systems in OC/EC analysis. Nevertheless, a clear separation between OC and EC is not easy to achieve either using more sophisticated systems such as TOT or TOR.

TGA/FT-IR was applied to the characterization of PM10 samples collected in the urban area of Milan to determine the EC/OC/TC content. The technique reliability was qualitatively demonstrated by the good correlation between the particulate mass and its carbonaceous component. As for the method sensitivity, EC values were often below the detection limit but this is mainly due to the fact that the filters were sampled with four-hour time resolution.

*Acknowledgements.* The authors are grateful to G. Marcazzan (University of Milan) for the helpful suggestions.

---

### A TGA/FT-IR study for OC and EC quantification

P. Fermo et al.

---

Title Page

Abstract

Introduction

Conclusions

References

Tables

Figures

⏪

⏩

◀

▶

Back

Close

Full Screen / Esc

Print Version

Interactive Discussion

## References

- Birch, M. E. and Cary, R. A.: Elemental Carbon-Based Method for Monitoring Occupational Exposures to Particulate Diesel Exhaust, *Aerosol Sci. Technol.*, 25, 221–241, 1996.
- Cachier, H., Bremond, M. P., and Buat-Ménard, P.: Determination of atmospheric soot carbon with a simple thermal method, *Tellus*, 41B, 379–390, 1989.
- Cadle, S. H., Groblicki, P. J., and Stroup, D. P.: Automated Carbon Analyzer for Particulate Samples, *Anal. Chem.*, 52, 2201–2206, 1980.
- Chow, J. C., Watson, J. G., Pritchett, L. C., Pierson, W. R., Frazier, C. A., and Purcell, R. G.: Equivalence of Elemental Carbon by the IMPROVE and STN Thermal/Optical Carbon Analysis Methods, *Atmos. Environ.*, 27A, 1185–1201, 1993.
- Chow, J. C., Watson, J. G., Crow, D., Lowenthal, D. H., and Merrifield, T.: Comparison of IMPROVE and NIOSH Carbon Measurements, *Aerosol Sci. Technol.*, 34, 23–34, 2001.
- Chow, J. C., Watson, J. G., Chen, L. W. A., Arnott, W. P., and Moosmüller, H.: The DRI thermal/optical reflectance carbon analysis system: description, evaluation and applications in U.S. air quality studies, *Environ. Sci. Technol.*, 38, 4414–4422, 2004.
- Currie, L. A., Benner Jr., B. A., Kessler, J. D., Klinedinst, D. B., Klouda, J. A., Marolf, J. V., Slater, J. F., Wise, S. A., Cachier, H., Cary, R., Chow, J. C., Watson, J., Druffel, E. R. M., Masiello, C. A., Eglinton, T. I., Pearson, A., Reddy, C. M., Gustafsson, Ö., Quinn, J. G., Hartmann, P. C., Hedges, J. I., Prentice, K. M., Kirchstetter, T. W., Novakov, T., Puxbaum, H., and Schmid, H., J.: A Critical Evaluation of Interlaboratory Data on Total, Elemental, and Isotopic Carbon in the Carbonaceous Particle Reference Material, NIST SRM 1649a, *J. Res. Inst. Stand. Technol.*, 107, 279–298, 2002.
- Decesari, S., Facchini, M. C., Matta, E., Lettini, F., Mircea, M., Fuzzi, S., Tagliavini, E., and Putaud, J.-P.: Chemical features and seasonal variation of the fine aerosol water-soluble organic compounds in the Po Valley, Italy, *Atmos. Environ.*, 35, 3691–3699, 2001.
- Delumyea, R. G., Chu, L. C., and Macias, E. S.: Determination of elemental carbon component of soot in ambient aerosol samples, *Atmos. Environ.*, 14, 647–652, 1980.
- Duan, F., Liu, X., Yu, T., and Cachier, H.: Identification and estimate of biomass burning contribution to the urban aerosol organic carbon concentrations in Beijing, *Atmos. Environ.*, 38, 1275–1282, 2004.
- Ellis, R. C., Novakov, T., and Zeldin, M. D.: Thermal characterization of organic aerosols, *Sci. Total Environ.*, 36, 261–270, 1984.

---

### A TGA/FT-IR study for OC and EC quantification

P. Fermo et al.

---

Title Page

Abstract

Introduction

Conclusions

References

Tables

Figures

◀

▶

◀

▶

Back

Close

Full Screen / Esc

Print Version

Interactive Discussion

---

**A TGA/FT-IR study for  
OC and EC  
quantification**

---

P. Fermo et al.

[Title Page](#)[Abstract](#)[Introduction](#)[Conclusions](#)[References](#)[Tables](#)[Figures](#)[◀](#)[▶](#)[◀](#)[▶](#)[Back](#)[Close](#)[Full Screen / Esc](#)[Print Version](#)[Interactive Discussion](#)

EGU

- Fermo, P., Gilardoni, S., Jaouni Simarro, T., Bolzacchini, E., Lasagni, M., Gianelle, V., Pozzoli, L., Perrone, M. G., and Librando, V.: Measurement of the carbonaceous component in the Milan urban particulate matter, *Ann. Chim.-Rome*, 93, 389–396, 2003.
- Iwatsuki, M., Kyotani, T., and Matsubara, K.: Fractional Determination of Elemental Carbon and Total Soluble and Insoluble Organics Compounds in Airborne Particulate Matter by Thermal Analysis Combined with Extraction and Heavy Liquid Separation, *Anal. Sci.*, 14, 321–326, 1998.
- Novakov, T.: Airborne measurements of carbonaceous aerosols on the East Coast of the United States, *J. Geophys. Res.*, 102(D25), 30 023–30 030, 1997.
- Oberdörster, G. and Yu, C. P.: The carcinogenic potential of inhaled diesel exhaust – a particle effect, *J. Aerosol Sci.*, 21, S397–S401, 1990.
- Ohta, S. and Okita, T.: Measurements of particulate carbon in urban and marine air in Japanese areas, *Atmos. Environ.*, 18, 2439–2445, 1984.
- Pozzoli, L., Gilardoni, S., Perrone, M. G., de Gennaro, G., de Rienzo, M., and Vione, D.: Polycyclic aromatic hydrocarbons in the atmosphere: Monitoring, sources, sinks and fate. I: Monitoring and sources, *Ann. Chim.-Rome*, 94, 17–33, 2004.
- Ruellan, S. and Cachier, H.: Characterization of fresh particulate vehicular exhausts near a Paris high flow road, *Atmos. Environ.*, 35, 453–468, 2001.
- Salma, I., Chi, X., and Maenhaut, W.: Elemental and organic carbon in urban canyon and background environments in Budapest, Hungary, *Atmos. Environ.*, 38, 27–36, 2004.
- Schmid, H., Laskus, L., Habraham, H. J., Baltensperger, U., Lavanchy, V., Bizjak, M., Burba, P., Cachier, H., Crow, D., Chow, J., Gnauk, T., Even, A., Ten Brink, H. M., Giesen, K. P., Hitzenberger, R., Hueglin, C., Maenhaut, W., Pio, C., Carvalho, A., Putaud, J. P., Toom-Saunty, D., and Puxbaum, H.: Results of the “carbon conference” international aerosol carbon round robin test stage I, *Atmos. Environ.*, 35, 2111–2121, 2001.
- Seinfeld, J. H. and Pandis, S. N.: *Atmospheric Chemistry and Physics*, Wiley, New York, 1998.
- Sesana, L., Caprioli, E., and Marazzan, G. M.: Long period study of outdoor radon concentration in Milan and correlation between its temporal variations and dispersion properties of atmosphere, *J. Environ. Radioactiv.*, 65, 147–160, 2003.
- Summerhays, J.: Evaluation of risks from urban air-pollutants in the Southeast Chicago area, *J. Air Waste Manage. Assoc.*, 41, 844–850, 1991.
- Tanner, R. L., Gaffney, J. F., and Phillips, M. F.: Determination of Organic and Elemental Carbon in Atmospheric Aerosol Samples by Thermal Evolution, *Anal. Chem.*, 54, 1627–1630, 1982.

Turpin, B. J. and Huntzicker, J. J.: Identification of secondary organic aerosol episodes and quantification of primary and secondary organic aerosol concentrations during SCAQS, Atmos. Environ., 29, 3527–3544, 1995.

5 Turpin, B. J., Saxena, P., and Andrews, E.: Measuring and simulating particulate organics in the atmosphere: problems and prospects, Atmos. Environ., 34, 2983–3013, 2000.

Turpin, B. J. and Lim, H. J.: Species Contributions to PM<sub>2.5</sub> Mass Concentrations: Revisiting Common Assumptions for Estimating Organic Mass, Aerosol Sci. Technol., 35 (1), 602–610, 2001.

10 Vecchi, R., Marcazzan, G. M., Valli, G., Ceriani, M., and Antoniazzi, C.: The role of the atmospheric dispersion in the seasonal variation of PM<sub>1</sub> and PM<sub>2.5</sub> concentration and composition in the urban area of Milan (Italy), Atmos. Environ., 38, 4437–4446, 2004.

Yao, X., Fang, M., and Chan, C. K.: Size distribution and formation of dicarboxylic acids in atmospheric particles, Atmos. Environ., 36, 2099–2107, 2002.

---

**A TGA/FT-IR study for  
OC and EC  
quantification**

P. Fermo et al.

---

Title Page

Abstract

Introduction

Conclusions

References

Tables

Figures

◀

▶

◀

▶

Back

Close

Full Screen / Esc

Print Version

Interactive Discussion



**A TGA/FT-IR study for  
OC and EC  
quantification**

P. Fermo et al.

**Table 1.** Experimental conditions used for TGA/FT-IR analyses; standards composition are reported in Sect. 2.1.

experiment No.	sample	first step T (°C)	first isotherm duration (min)	second step T (°C)	second isotherm duration (min)	carbon % recovered in the first step
1	Std a	350	120	700	10	72
2	Std a	425	10	700	10	84
3	Std b	350	10	700	10	60
4	Std b	425	10	700	10	90
5	ambient sample	435	25	700	10	
6	Std b	435	25	700	10	90

[Title Page](#)[Abstract](#)[Introduction](#)[Conclusions](#)[References](#)[Tables](#)[Figures](#)[◀](#)[▶](#)[◀](#)[▶](#)[Back](#)[Close](#)[Full Screen / Esc](#)[Print Version](#)[Interactive Discussion](#)

EGU

## A TGA/FT-IR study for OC and EC quantification

P. Fermo et al.

**Table 2.** Standards used for the calibration curve shown in Fig. 7a; together with the standard type are reported the weight, the carbon quantity present and the peak area observed in the CEC.

Std type	Std weight (mg)	Carbon quantity (mg)	Peak area
No sample	0		11.4
d2	5.35	0.009	18.7
d2	5.82	0.010	24.0
d1	0.54	0.025	52.6
d2	43.52	0.074	114.4
d2	44.83	0.076	94.7
d3	23.30	0.077	108.8
d3	41.50	0.137	187.0
d3	42.99	0.142	167.0

Title Page

Abstract

Introduction

Conclusions

References

Tables

Figures

◀

▶

◀

▶

Back

Close

Full Screen / Esc

Print Version

Interactive Discussion

EGU

## A TGA/FT-IR study for OC and EC quantification

P. Fermo et al.

**Table 3.** Standards used for the calibration curve shown in Fig. 7b; together with the standard type are reported the weight of  $\frac{1}{2}$  filter, the carbon quantity present and the peak area observed in the CEC.

Std type	Std weight on $\frac{1}{2}$ filter(mg)	Carbon quantity (mg)	Peak area
$\frac{1}{2}$ blank filter	0	0	17.30
d1	0.1715	0.008	23.47
d1	0.2770	0.013	29.99
d1	0.5230	0.025	37.47
d1	0.7015	0.033	44.52
d1	0.7015	0.033	48.00
d1	1.2985	0.061	65.60
d1	1.4805	0.070	91.65
d1	1.7910	0.084	96.48

Title Page

Abstract

Introduction

Conclusions

References

Tables

Figures

◀

▶

◀

▶

Back

Close

Full Screen / Esc

Print Version

Interactive Discussion

EGU

---

**A TGA/FT-IR study for  
OC and EC  
quantification**P. Fermo et al.

---

**Table 4.** PM10 and PM2.5 samples analyzed by both thermal-optical method TOT (Sunset Lab inc.) and TGA/FT-IR.

Sample name	Dimensional fraction	Sampling date
C1	PM 2.5	3 July 2001
C4	PM 2.5	17 July 2001
C6	PM 10	5 July 2001

[Title Page](#)[Abstract](#)[Introduction](#)[Conclusions](#)[References](#)[Tables](#)[Figures](#)[◀](#)[▶](#)[◀](#)[▶](#)[Back](#)[Close](#)[Full Screen / Esc](#)[Print Version](#)[Interactive Discussion](#)

EGU

**A TGA/FT-IR study for  
OC and EC  
quantification**

P. Fermo et al.

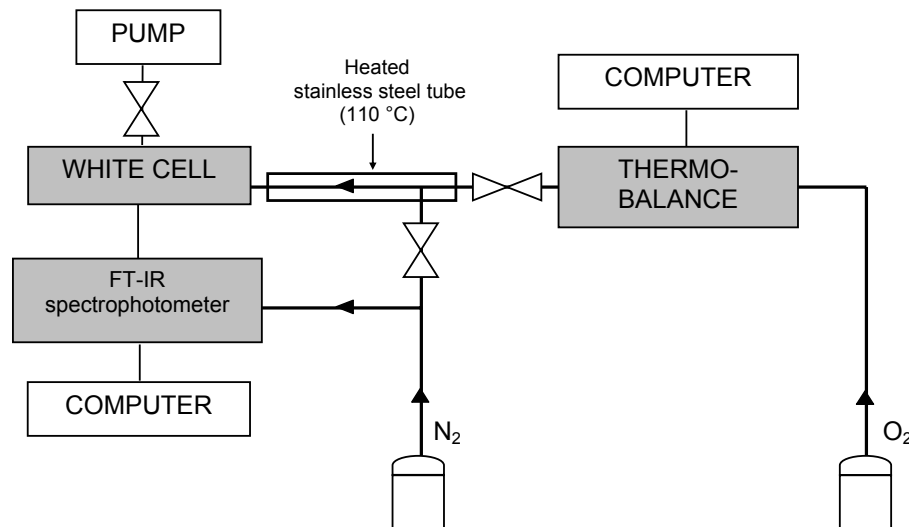

**Fig. 1.** Diagram of the carbon analyzer obtained by coupling a thermo-gravimetric analyzer (TGA) with an infrared spectrophotometer (FT-IR).

[Title Page](#)[Abstract](#)[Introduction](#)[Conclusions](#)[References](#)[Tables](#)[Figures](#)[◀](#)[▶](#)[◀](#)[▶](#)[Back](#)[Close](#)[Full Screen / Esc](#)[Print Version](#)[Interactive Discussion](#)

EGU

**A TGA/FT-IR study for  
OC and EC  
quantification**

P. Fermo et al.

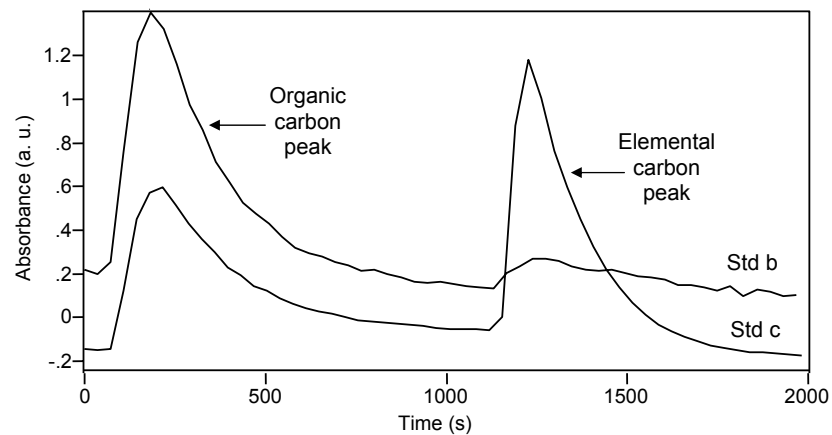

(a)

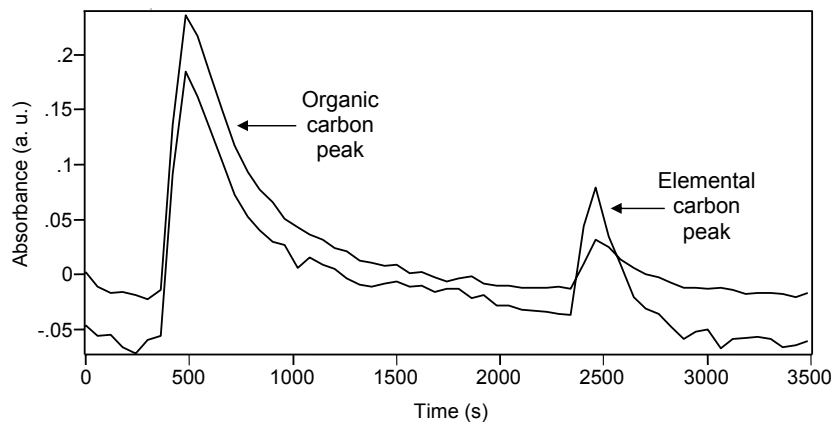

(b)

**Fig. 2.** CECs (CO<sub>2</sub> Evolution Curves) obtained by TGA/FT-IR analyzing standard b and c (a) and two particulate matter samples deposited on quartz fiber filters (b); the peaks due to organic carbon (OC) and elemental carbon (EC) are indicated with arrows.

[Title Page](#)[Abstract](#)[Introduction](#)[Conclusions](#)[References](#)[Tables](#)[Figures](#)[◀](#)[▶](#)[◀](#)[▶](#)[Back](#)[Close](#)[Full Screen / Esc](#)[Print Version](#)[Interactive Discussion](#)

EGU

---

**A TGA/FT-IR study for  
OC and EC  
quantification**P. Fermo et al.

---

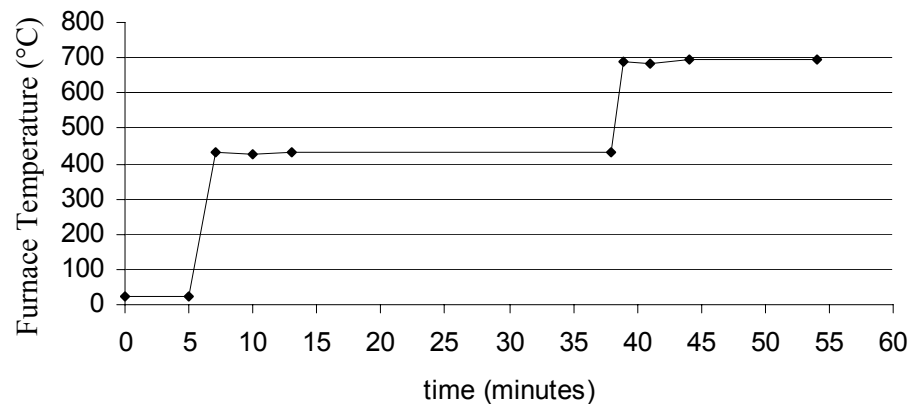

**Fig. 3.** Heating program employed for the analysis of particulate matter samples by TGA/FT-IR.

[Title Page](#)[Abstract](#)[Introduction](#)[Conclusions](#)[References](#)[Tables](#)[Figures](#)[◀](#)[▶](#)[◀](#)[▶](#)[Back](#)[Close](#)[Full Screen / Esc](#)[Print Version](#)[Interactive Discussion](#)

EGU

---

**A TGA/FT-IR study for  
OC and EC  
quantification**P. Fermo et al.

---

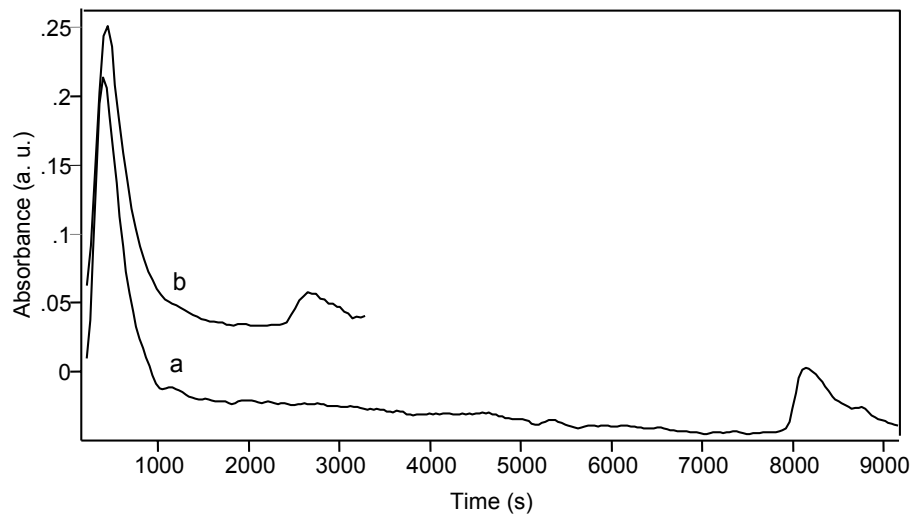

**Fig. 4.** CECs obtained by TGA/FT-IR analyzing standard a and corresponding to experiment No. 1 – Table 1 (curve a) and experiment No. 2 – Table 1 (curve b).

[Title Page](#)[Abstract](#)[Introduction](#)[Conclusions](#)[References](#)[Tables](#)[Figures](#)[◀](#)[▶](#)[◀](#)[▶](#)[Back](#)[Close](#)[Full Screen / Esc](#)[Print Version](#)[Interactive Discussion](#)

EGU



---

**A TGA/FT-IR study for  
OC and EC  
quantification**P. Fermo et al.

---

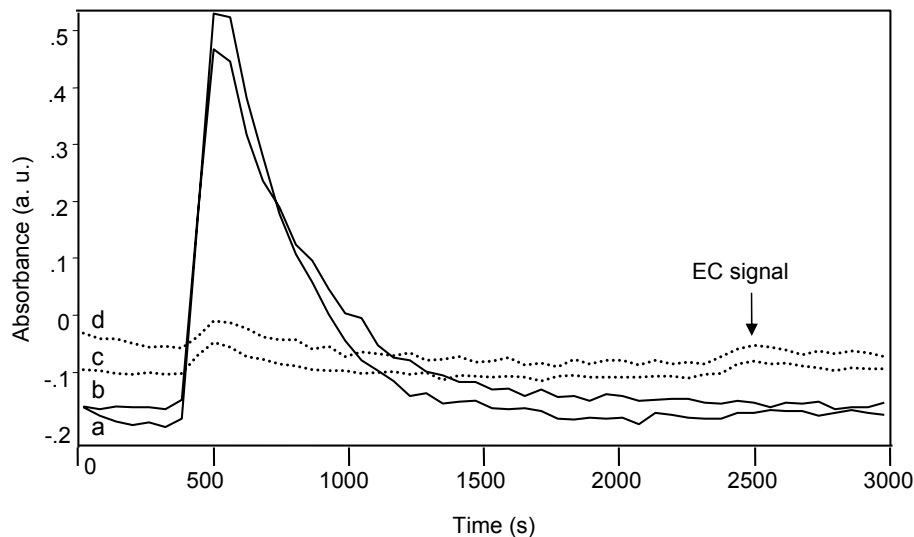

**Fig. 5.** CECs obtained by TGA/FT-IR analyzing a 24-h sample of particulate matter (on a filter). The filter was divided into two portions both heated at 425°C for 25 min (curves a and b); curve c was obtained with the heating program, reported in Fig. 3, on one half of the filter submitted to 24-h Soxhlet extraction; curve d was obtained by the same heating program on the second half of the filter not extracted.

[Title Page](#)[Abstract](#)[Introduction](#)[Conclusions](#)[References](#)[Tables](#)[Figures](#)[◀](#)[▶](#)[◀](#)[▶](#)[Back](#)[Close](#)[Full Screen / Esc](#)[Print Version](#)[Interactive Discussion](#)

EGU

**A TGA/FT-IR study for  
OC and EC  
quantification**

P. Fermo et al.

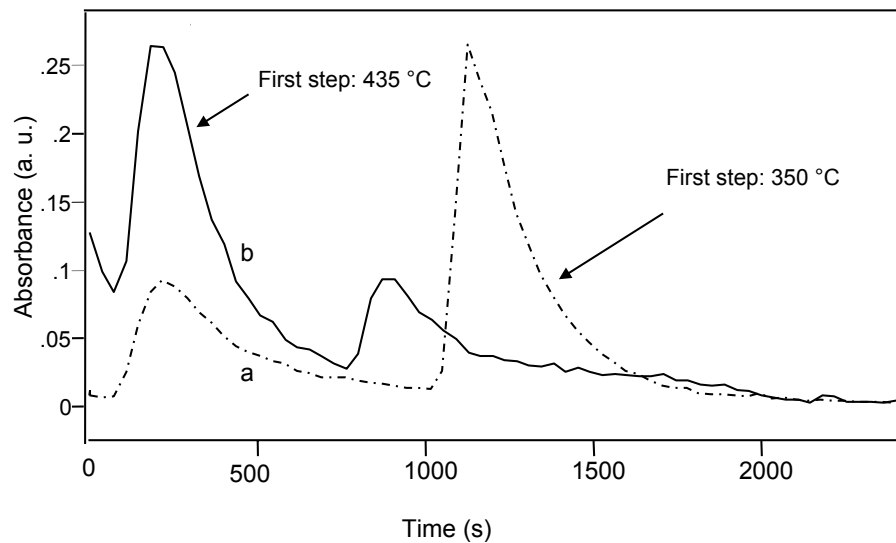

**Fig. 6.** CECs obtained by TGA/FT-IR analyzing SRM1649a using a first temperature step of respectively 350°C (curve a) and 435°C (curve b); the first isotherm duration was 25 min, the second temperature step 700°C and the second isotherm duration 10 min.

[Title Page](#)[Abstract](#)[Introduction](#)[Conclusions](#)[References](#)[Tables](#)[Figures](#)[◀](#)[▶](#)[◀](#)[▶](#)[Back](#)[Close](#)[Full Screen / Esc](#)[Print Version](#)[Interactive Discussion](#)

EGU

---

**A TGA/FT-IR study for  
OC and EC  
quantification**P. Fermo et al.

---

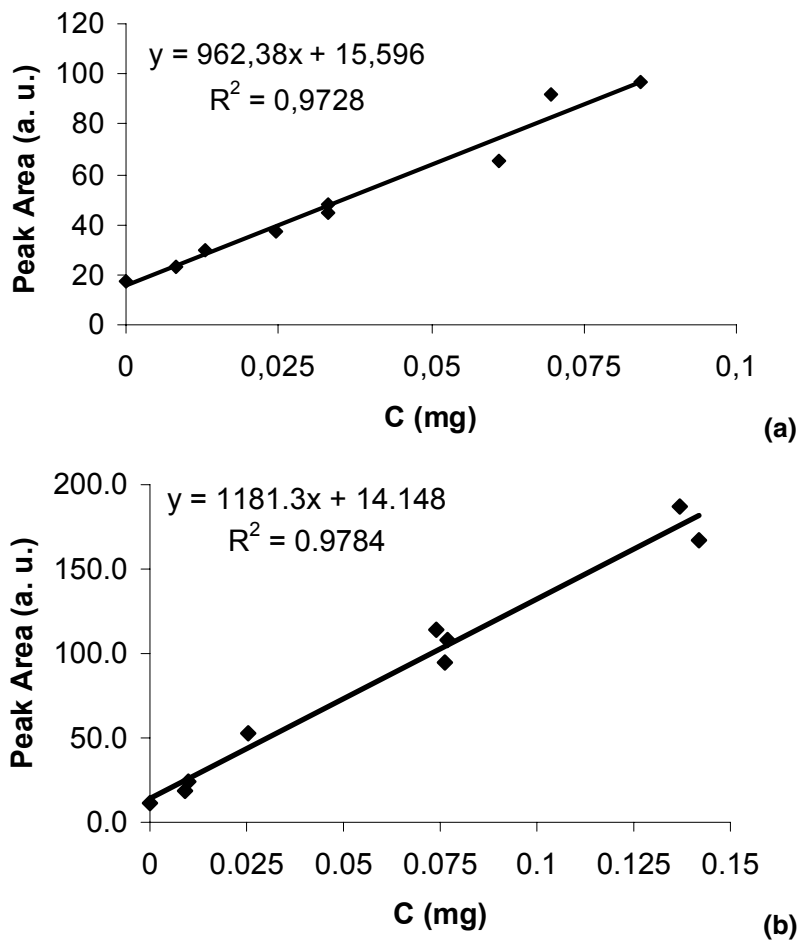

**Fig. 7.** Calibration curves obtained analyzing different quantities of standards d1, d2 and d3 (see Sect. 2.1 and Table 2) **(a)** and analyzing one half of the filter loaded with standard d1 in different quantities (see Table 3) **(b)**.

[Title Page](#)[Abstract](#)[Introduction](#)[Conclusions](#)[References](#)[Tables](#)[Figures](#)[◀](#)[▶](#)[◀](#)[▶](#)[Back](#)[Close](#)[Full Screen / Esc](#)[Print Version](#)[Interactive Discussion](#)

EGU

**A TGA/FT-IR study for  
OC and EC  
quantification**

P. Fermo et al.

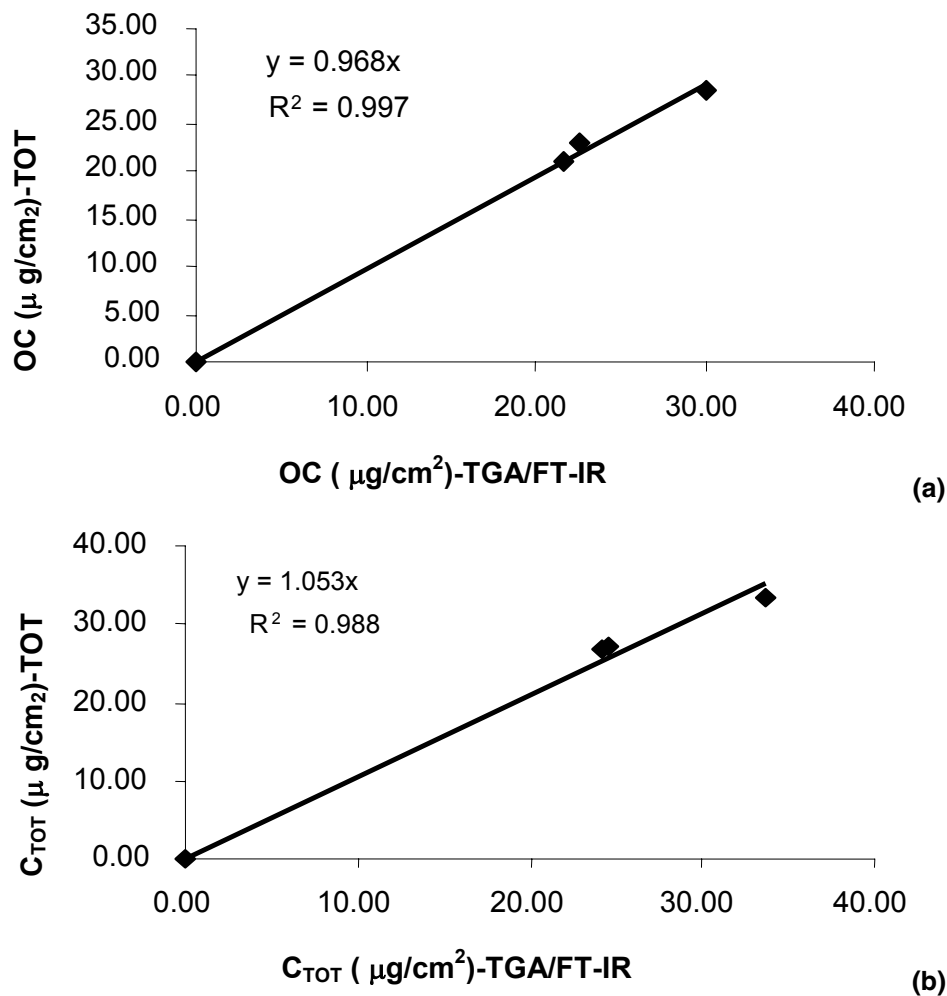
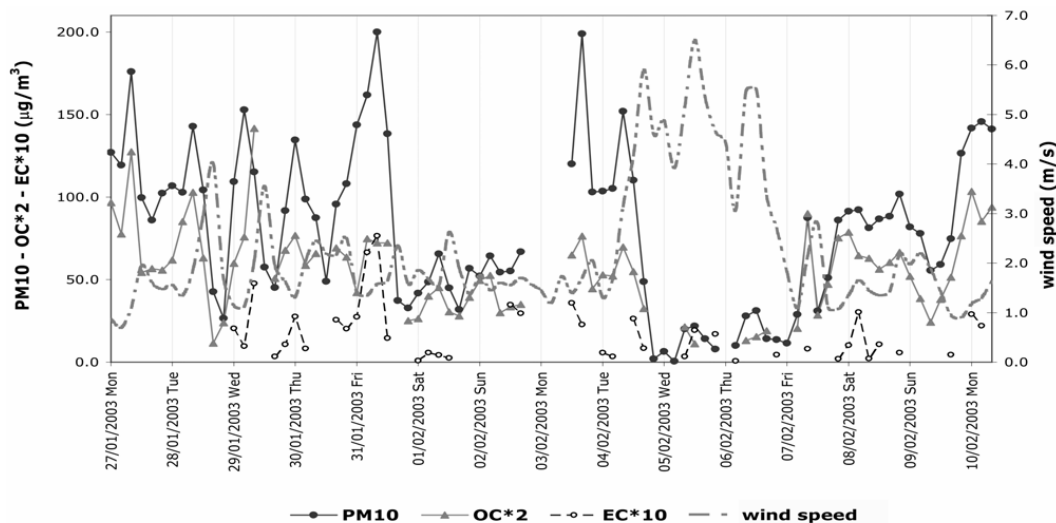

**Fig. 8.** Comparison between TGA/FT-IR and TOT methodologies for OC concentrations **(a)** and total carbon concentrations **(b)**.

[Title Page](#)[Abstract](#)[Introduction](#)[Conclusions](#)[References](#)[Tables](#)[Figures](#)[◀](#)[▶](#)[◀](#)[▶](#)[Back](#)[Close](#)[Full Screen / Esc](#)[Print Version](#)[Interactive Discussion](#)

**A TGA/FT-IR study for  
OC and EC  
quantification**

P. Fermo et al.



**Fig. 9.** Temporal patterns of PM10, OC and EC concentrations together with wind speed (OC and EC values have been multiplied respectively  $\times 2$  and  $\times 10$ ).

[Title Page](#)[Abstract](#)[Introduction](#)[Conclusions](#)[References](#)[Tables](#)[Figures](#)[◀](#)[▶](#)[◀](#)[▶](#)[Back](#)[Close](#)[Full Screen / Esc](#)[Print Version](#)[Interactive Discussion](#)

EGU

## A TGA/FT-IR study for OC and EC quantification

P. Fermo et al.

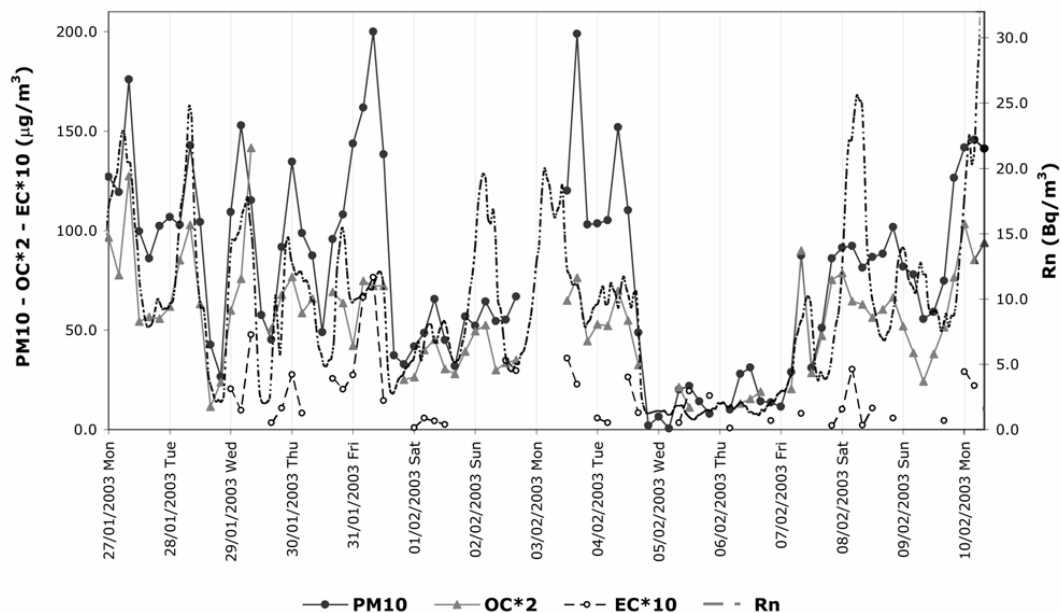

**Fig. 10.** Temporal patterns of  $PM_{10}$ , OC and EC concentrations together with Radon concentration (OC and EC values have been multiplied respectively  $\times 2$  and  $\times 10$ ).

Title Page

Abstract

Introduction

Conclusions

References

Tables

Figures

◀

▶

◀

▶

Back

Close

Full Screen / Esc

Print Version

Interactive Discussion

EGU