



**HAL**  
open science

## A method for detecting the presence of organic fraction in nucleation mode sized particles

P. Vaattovaara, M. Räsänen, T. Kühn, J. Joutsensaari, A. Laaksonen

► **To cite this version:**

P. Vaattovaara, M. Räsänen, T. Kühn, J. Joutsensaari, A. Laaksonen. A method for detecting the presence of organic fraction in nucleation mode sized particles. *Atmospheric Chemistry and Physics Discussions*, 2005, 5 (3), pp.3595-3620. hal-00301552

**HAL Id: hal-00301552**

**<https://hal.science/hal-00301552>**

Submitted on 18 Jun 2008

**HAL** is a multi-disciplinary open access archive for the deposit and dissemination of scientific research documents, whether they are published or not. The documents may come from teaching and research institutions in France or abroad, or from public or private research centers.

L'archive ouverte pluridisciplinaire **HAL**, est destinée au dépôt et à la diffusion de documents scientifiques de niveau recherche, publiés ou non, émanant des établissements d'enseignement et de recherche français ou étrangers, des laboratoires publics ou privés.

Detection of organic  
fraction using the  
UFO-TDMA

P. Vaattovaara et al.

# A method for detecting the presence of organic fraction in nucleation mode sized particles

P. Vaattovaara<sup>1</sup>, M. Räsänen<sup>1</sup>, T. Kühn<sup>2</sup>, J. Joutsensaari<sup>3</sup>, and A. Laaksonen<sup>1</sup>

<sup>1</sup>Department of Applied Physics, University of Kuopio, P.O. Box 1627, FIN-70211 Kuopio, Finland

<sup>2</sup>Institut for Analytical Sciences, P.O. Box 101 352, D-44013 Dortmund, Germany

<sup>3</sup>Department of Environmental Sciences, University of Kuopio, P.O. Box 1627, FIN-70211 Kuopio, Finland

Received: 16 March 2005 – Accepted: 2 May 2005 – Published: 1 June 2005

Correspondence to: P. Vaattovaara (petri.vaattovaara@uku.fi)

© 2005 Author(s). This work is licensed under a Creative Commons License.

Title Page

Abstract

Introduction

Conclusions

References

Tables

Figures

◀

▶

◀

▶

Back

Close

Full Screen / Esc

Print Version

Interactive Discussion

EGU

## Abstract

New particle formation and growth has a very important role in many climate processes. However, the overall knowledge of the chemical composition of atmospheric nucleation mode (particle diameter,  $d < 20$  nm) and the lower end of Aitken mode particles ( $d \leq 50$  nm) is still insufficient. In this work, we have applied the UFO-TDMA (ultrafine organic tandem differential mobility analyzer) method to shed light on the presence of organic fraction in the nucleation mode size class in different atmospheric environments. The basic principle of the organic fraction detection is based on our laboratory UFO-TDMA measurements with organic and inorganic compounds. Our laboratory measurements indicate that the usefulness of the UFO-TDMA in the field experiments would arise especially from the fact that atmospherically the most relevant inorganic compounds do not grow in subsaturated ethanol vapor, when particle size is 10 nm in diameter and saturation ratio is about 86% or below it. Furthermore, internally mixed particles composed of ammonium bisulfate and sulfuric acid with sulfuric acid mass fraction  $\leq 33\%$  show no growth at 85% saturation ratio. In contrast, 10 nm particles composed of various organic compounds of atmospheric relevance are able to grow in those conditions. These discoveries indicate that it is possible to detect the presence of organics in atmospheric nucleation mode sized particles using the UFO-TDMA method. In the future, the UFO-TDMA is expected to be an important aid to describe the composition of atmospheric newly-formed particles.

## 1. Introduction

Newly-formed nanometer-sized particles can grow to larger aerosol particles and cloud condensation nuclei (CCN), which scatter incoming radiation and contribute a direct and an indirect (via clouds) cooling effect to the Earth's radiation budget (Slingo, 1990). While a significant amount of new nanometer-sized particles are lost through coagulation scavenging, a noticeable fraction may grow by both gas-to-particle conversion

## Detection of organic fraction using the UFO-TDMA

P. Vaattovaara et al.

Title Page

Abstract

Introduction

Conclusions

References

Tables

Figures

⏪

⏩

◀

▶

Back

Close

Full Screen / Esc

Print Version

Interactive Discussion

---

**Detection of organic fraction using the UFO-TDMA**P. Vaattovaara et al.

---

[Title Page](#)[Abstract](#)[Introduction](#)[Conclusions](#)[References](#)[Tables](#)[Figures](#)[◀](#)[▶](#)[◀](#)[▶](#)[Back](#)[Close](#)[Full Screen / Esc](#)[Print Version](#)[Interactive Discussion](#)

EGU

and coagulation processes (Mäkelä et al., 1997) into Aitken and accumulation modes. Thus, new particle formation and growth has a very important role in many climate processes. Furthermore, ultrafine particles (particle diameter,  $d \leq 100$  nm) have been shown to relate to adverse health effects (e.g. Ibald-Mulli et al., 2002).

5 However, details of the processes controlling nucleation and growth in the ultrafine size range in different environments (e.g. boreal, urban, coastal) are still widely undetermined. To understand properly particle formation and growth and their effects on climate processes, the chemical composition of ultrafine particles need to be characterized. Because of the difficulties in studying the composition of the ultrafine particles, the overall knowlegde of the chemical composition of atmospheric nucleation and the lower  
10 end of Aitken mode particles ( $d \leq 50$  nm) is still insufficient. Especially, below 20 nm (in diameter) very little information is available on particle compositions. It is very difficult to study those particles by any method, because of their very small masses, the fact that the possible constituents include hundreds or thousands of compounds, and the possibility that chemical reactions may change their composition as a function of time.

The ultrafine particles can be composed of inorganic and/or organic compounds, which both are known to be important in the Earth's atmospheric processes, and their presence in the nucleation mode particles is expected to be related to local environments (e.g. coastal vs. boreal). In this work, the UFO-TDMA (ultrafine organic tandem  
20 differential mobility analyzer) method has been applied to shed light on the presence of organic fraction in the nucleation mode size class (i.e.  $d < 20$  nm). The basic principle of the organic fraction detection is based on our laboratory UFO-TDMA measurements with organic and inorganic compounds (measurement range 6–50 nm in diameter). Our laboratory measurements, presented more detail in the following sections, indicate that  
25 the usefulness of the UFO-TDMA in the field experiments would arise especially from the fact that atmospherically the most relevant inorganic compounds do not grow in subsaturated ethanol vapor, when particle size is 10 nm in diameter and saturation is about 86% or below it. Furthermore, the internal mixtures of ammonium bisulfate and sulfuric acid with sulfuric acid mass fraction below 33% show no growth at 85% satu-

ration ratio when the particle size is 10 nm. In contrast, various organic compounds of atmospheric relevance are able to grow in those conditions.

## 2. Methods

### 2.1. The UFO-TDMA system

5 In this work, the ultrafine organic tandem differential mobility analyzer (UFO-TDMA) was used in laboratory conditions to test growth factors (GFs) of atmospherically the most relevant inorganic and some relevant organic compounds in size classes of the lower end of ultrafine particles (i.e.  $6 \leq d \leq 50$  nm). In the present UFO-TDMA system, ethanol (purity 99.7 weight percent) is used as the organic solvent. Figure 1 shows  
10 a schematic diagram of the UFO-TDMA setup. The first DMA (Differential Mobility Analyzer; Hauke type, length 11 cm; Winklmayr, 1991) classifies a desired size (for example, 10 nm) from a polydisperse aerosol flow, after which the selected particles are introduced into air with a known solvent saturation ratio  $S$ . The second DMA, identical to the first one, then measures the change in particle size due to the interaction  
15 with the subsaturated ethanol vapor. The growth factors, i.e., the final diameter after vapor uptake divided by the initial “dry” diameter of the particles, are characteristic for each particle composition. In the growth factor calculations, the geometric number mean diameter of the measured size distribution was used as an average particle size. The number size distributions were determined using a standard DMA data inversion  
20 algorithm (Knutson and Whitby, 1975; Reischl, 1991).

The UFO-TDMA used in this study was built following guidelines of the O-TDMA (Joutsensaari et al., 2001) system but with the some differences: shorter DMAs (Hauke type, length 11 cm; Winklmayr, 1991) and high voltage power supplies (F.u.G. Elektronik GmbH, Germany) with lower maximum voltages (1.25 kV for the first DMA and  
25 2 kV for the second DMA) were used in the UFO-TDMA. Additionally, to decrease diffusion losses of the ultrafine particles, the length of all lines was minimized in the whole

---

## Detection of organic fraction using the UFO-TDMA

P. Vaattovaara et al.

---

Title Page

Abstract

Introduction

Conclusions

References

Tables

Figures

◀

▶

◀

▶

Back

Close

Full Screen / Esc

Print Version

Interactive Discussion

---

**Detection of organic fraction using the UFO-TDMA**P. Vaattovaara et al.

---

[Title Page](#)[Abstract](#)[Introduction](#)[Conclusions](#)[References](#)[Tables](#)[Figures](#)[◀](#)[▶](#)[◀](#)[▶](#)[Back](#)[Close](#)[Full Screen / Esc](#)[Print Version](#)[Interactive Discussion](#)

EGU

system. The DMAs were operated with aerosol and sheath flows of 1 and 10 L/min, respectively. With this configuration, the largest measurable particle diameter is about 85 nm. Bipolar neutralizer was radioactive  $^{63}\text{Ni}$   $\beta$ -source (370 MBq, 29 January 2003; AEA Technology QSA GmbH). The ethanol saturator was only used in the sheath line, i.e., particles were treated with ethanol only inside the second DMA by ethanol-rich sheath air (ethanol treatment time was about 1 s in order to avoid chemical reactions; Joutsensaari et al., 2004), and ethanol-rich sheath air was produced by bubbling dry air through liquid ethanol, which was heated in a temperature controlled (32°C) water bath (HBR 4D, IKA). Furthermore, in order to avoid temperature differences in the flows of the second DMA and to keep the temperature constant, the system temperature (~25°C) was controlled by an effective water bath (RCG CS, Lauda) heating/cooling a water circulation covering the second DMA in the thermal insulated box. Ethanol friendly Sol-Vent (Gelman Sciences) filters were used instead of HEPA (high efficiency particle arresting) filters in the ethanol vapor lines. The saturation ratio of the ethanol vapor was determined using a dew point meter (General Eastern, Hygro M4 with model D-2 chilled mirror sensor; accuracy  $\pm 0.2^\circ\text{C}$  for water vapor) with a corrosive durable mirror. In order to apply the dew point meter for ethanol vapor (if one excludes water or ethanol, one can measure the other; G. Schultz, private communication, 29 January 2000), dried and purified sheath air (water saturation ratio about 0.03) was used. The temperature difference between the saturator and the condenser in the CPC was also maximized to 25 K (condensation particle counter, TSI 3010; Quant et al., 1992) to detect particles down to 6 nm (Mertes et al., 1995). Because of the comparably low voltages used in the short DMAs, sparks that could ignite the ethanol vapor do not occur. The UFO-TDMA system can therefore be used without supervision, making diurnal measurements possible.

## 2.2. Laboratory measurements

The aerosol particles were generated from aqueous (particles are usually in aqueous form in atmospheric air) precursor solutions by a constant output atomizer with a dry

---

**Detection of organic fraction using the UFO-TDMA**P. Vaattovaara et al.

---

[Title Page](#)[Abstract](#)[Introduction](#)[Conclusions](#)[References](#)[Tables](#)[Figures](#)[◀](#)[▶](#)[◀](#)[▶](#)[Back](#)[Close](#)[Full Screen / Esc](#)[Print Version](#)[Interactive Discussion](#)

EGU

airflow of 3 L/min. The precursor water (Milli-Q water, Millipore; de-ionized and distilled) solution was fed to the sample line by a syringe pump (Hostec R-50, Finland) and a peristaltic pump (Pharmacia, Fine Chemicals, Sweden). The generated aerosol was diluted immediately after the generator with a dry and purified airflow (screw compressor, Atlas Copco, ZT30, 25°C; pre-filter (EU 7); Domnick hunter drier, PNEUDRI MiDAS, DAS 2) of ~27 L/min. During the dilution (dilution ratio 1/10), the water evaporated from formed droplets, thus forming solid particles. RH (relative humidity) of the aerosol flow was typically about 3% after the first DMA.

In order to solve the growth for atmospherically the most relevant inorganic compounds of the lower end of Aitken mode (i.e.  $d \leq 50$  nm) and the nucleation mode (i.e.  $d < 20$  nm) sized particles, growth factors (GFs) were measured for ammonium sulfate, ammonium bisulfate, sodium chloride, iodine tetroxide, iodine pentoxide and ammonium nitrate, respectively, in subsaturated ethanol vapor. Typically, ammonium, sulfate and nitrate ions have been found in air masses from various origins (e.g. Putaud et al., 2004), while iodine oxides (e.g. Burkholder et al., 2004; McFiggans et al., 2004) and sodium chloride (included to sea salt) (O'Dowd et al., 2004) are related to marine origin.

Additionally, GFs were measured for acidic ammoniated sulfate particles created by mixing ammonium bisulfate, a dissociation product of sulfuric acid in the aqueous phase, with mass fraction of 18%–50% of sulfuric acid, which is expected to be an important and typical component in atmospheric air during new particle formation events (Laaksonen et al., 1995; Kulmala, 2003; Kulmala et al., 2004). Usually, there is a lot of anthropogenic ammonia to neutralize at least a part of sulfuric acid in the tropospheric particles. It is probable in those conditions that sulfuric acid is transformed to more ammonium bisulfate and ammonium sulfate like forms in the aqueous particle phase (Seinfeld and Pandis, 1998). Interestingly, the recent study of Vehkamäki et al. (2004) implies that all sulfuric acid in the atmosphere seems to be bound to tiny ammonium bisulfate clusters which are the basic building blocks in the nucleation process.

For comparison, the growth factors of some atmospherically relevant organic com-

**Detection of organic fraction using the UFO-TDMA**

P. Vaattovaara et al.

Title Page

Abstract

Introduction

Conclusions

References

Tables

Figures

◀

▶

◀

▶

Back

Close

Full Screen / Esc

Print Version

Interactive Discussion

EGU

pounds were studied: citric acid ( $C_6H_8O_7$ ), tartaric acid ( $C_4H_6O_6$ ) and benzoic acid ( $C_7H_6O_2$ ). Citric acid has been shown to be an important species in marine waters (Creac'h, 1955) and in sea salt particles (Ming and Russell, 2001). Tartaric acid is found at continental rural and urban particulate matter, mainly during summer, suggesting biogenic origin (Röhl and Lammel, 2002). Aromatic benzoic acid has been shown to exist in urban particulate matter (e.g. Hamilton et al., 2004) and its source is anthropogenic (e.g. Seinfeld and Pandis, 1998).

Manufacturer, mole weight, density, purity and concentration of the individual compounds in precursor water solution are summarized in Table 1. Two kinds of precursor solutions were used for the iodine tetroxide experiments. This is because the stronger solution (0.05 M) did not produce a high enough particle concentration for the nucleation mode sized particles (i.e. 6–20 nm). However, the stronger precursor solution was needed for the lower end of Aitken mode sized particles (i.e. 20–50 nm). Because iodine tetroxide was not commercially available, it was selfmade following guidelines from Daehlie and Kjekshus (1964). The purity of iodine tetroxide was assured by Raman spectroscopy. The density information for it is based on CRC Handbook of Chemistry and Physics (1996). Mass fractions and concentrations in precursor water solution of sulfuric acid and ammonium bisulfate mixtures are summarized in Table 2.

The working fluid of the UFO-TDMA was ethanol (purity 99.7 mass weight percent). Because the purpose of these experiments is to aid interpreting the results of atmospheric field measurements, the ethanol saturation ratios were chosen to be between 72–88% which cover typical saturation values used in the field experiments (e.g. Petäjä et al., 2005). In this study, the classified dry diameters were 6, 8, 10, 20, 30 and 50 nm. In order to get dry diameters for GF calculations and to test if measured compounds or mixtures are volatile in the UFO-TDMA system, dry size (no ethanol vapor at all) measurements were carried out for all measured compounds and mixtures at each dry diameter.



### 3. Results and discussion

The results reveal that it is possible to detect the organic fraction in 10 nm particles by the UFO-TDMA method, even though the sulfuric acid mass fraction would be as high as 33%. The solubility and growth information for all measured individual compounds at 86% saturation ratio have been summarized in Table 3. The solubility (22°C) of iodine tetroxide was tested in ethanol by dissolving iodine tetroxide to 1 L pure ethanol, until the solution was saturated. The result 0.12 g/1 L means that iodine tetroxide can be regarded as insoluble in ethanol. The solubility for ammonium nitrate was not measured because it was volatile in 6–50 nm sizes. The solubility information for other compounds is based on CRC Handbook of Chemistry and Physics (1996).

The laboratory experiments show (Table 3) that atmospherically relevant 50 nm ammonium sulfate, sodium chloride, iodine pentoxide and iodine tetroxide particles do not grow at 86% ethanol saturation ratio. This indicates that 1) they will not grow at lower saturation ratios, and 2) smaller particles consisting of these materials will not grow at 86% or below. Furthermore, ammonium nitrate is too volatile to show any growth.

Figure 2 shows our growth factor data for 10–50 nm ammonium bisulfate particles at ethanol saturation ratios between 78% and 86%. It is seen that the GFs of particles become smaller with decreasing particle size. Compared with the behavior of 100 nm particles measured earlier by Joutsensaari et al. (2004), the GFs of 10–50 nm particles are markedly lower. Our calculations show that the difference between the 50 nm and 100 nm growth factors is too large to be explained by the Kelvin effect alone. In Joutsensaari et al. (2004), we argued that the 100 nm bisulfate growth is most likely related to their hygroscopicity (i.e. water affinity). The particles were produced from aqueous solution, and even though they were dried at low RH, they may have contained some water that prompts the ethanol uptake. When the residence time of the particles in the ethanol vapor was increased from about 2 s to 30 s the GF dropped close to unity, which was attributed to sulfate esterification reactions and decreased uptake of ethanol with the associated evaporation of water molecules. Now, it is probable that the amount

## Detection of organic fraction using the UFO-TDMA

P. Vaattovaara et al.

Title Page

Abstract

Introduction

Conclusions

References

Tables

Figures

◀

▶

◀

▶

Back

Close

Full Screen / Esc

Print Version

Interactive Discussion

---

**Detection of organic fraction using the UFO-TDMA**P. Vaattovaara et al.

---

[Title Page](#)[Abstract](#)[Introduction](#)[Conclusions](#)[References](#)[Tables](#)[Figures](#)[◀](#)[▶](#)[◀](#)[▶](#)[Back](#)[Close](#)[Full Screen / Esc](#)[Print Version](#)[Interactive Discussion](#)

EGU

of water held by the “dry” particles decreases with particle size (as a result of the Kelvin effect experienced by the water molecules). Furthermore, the Laplace pressure of the smaller particles may cause increased chemical reaction constants (e.g. Sanfeld et al., 2000; Sanfeld and Steichen, 2003) and thus, the chemical composition of the smaller particles may change more rapidly. Taken together, the low GFs seen in Fig. 2 may then be explained (1) by decreased water content of the smaller “dry” particles, (2) by the Kelvin effect of the ethanol-bisulfate droplets, and (3) by changed chemical composition due to the Laplace pressure especially in the smallest (10–20 nm) particles.

Mixed particles of ammonium bisulfate and sulfuric acid with sulfuric acid mass fractions of 18% (Fig. 3), 25% (Fig. 4), 33% (Fig. 5) and 50% (Fig. 6) grow, when particle diameter is 50 nm and saturation ratio about 85%. The mixtures behave qualitatively in a similar manner as the pure bisulfate particles as the GFs decrease quite pronouncedly as a function of particle size. As with the ammonium bisulfate particles, the decrease is stronger than what would be expected based on the Kelvin effect alone. A point in case is the behavior of the 10 nm particles which show no growth for the 18–33% mixtures. Sulfuric acid is even more hygroscopic than ammonium bisulfate, and thus the explanation of the bisulfate particle behavior given above may also apply to the mixed particles.

The 10 nm particles consisting of 50% sulfuric acid solution show modest growth (Fig. 6), however, this should not affect our conclusions concerning atmospheric particles since the sulfuric acid solutions found in the boundary layer will always be much more dilute. For example, a low ammonia concentration environment study of Boy et al. (2004) estimated that sulfuric acid fraction is between 3 to 17% in newly formed particles during nucleation events. The very recent study of Fiedler et al. (2005) concluded that the percentage contribution of sulfuric acid to new particle formation and growth at a continental boreal forest area and at a polluted continental region are 5.9% and 4.3%, respectively. Thus, sulfuric acid mass fraction of 18%–33% used in our laboratory UFO-TDMA measurements is high enough to indicate that it is possible to carry out the UFO-TDMA field measurements at such a saturation ratio that sulfuric acid will

not cause any growth for 10 nm particles.

In contrast to inorganic compound growth behavior, the organic compounds citric acid (Fig. 7), tartaric acid (Fig. 8) and benzoic acid (Fig. 9) exhibit clear growth behavior, when particle size is 10–50 nm or even below that. Again, GFs decrease with decreasing particle size. The size dependence of the GFs may be explained for the most part with the Kelvin effect down to 20 nm particles. However, between 10 and 20 nm, quite a sizeable gap appears, which could once more be explained with changed chemical composition due to the Laplace pressure. The correctness of this explanation can be checked by varying the residence times of different sized particles in ethanol vapor and measuring the GFs. However, because of experimental difficulties related to increased diffusion losses of the smallest particles when the residence time is increased, we will leave reporting of the results to a follow-up publication.

#### 4. Conclusions

In this study, we have applied the UFO-TDMA method to detect the presence of organic fraction in atmospherically relevant nucleation mode sized particles. Based on our laboratory measurements, the usefulness of the UFO-TDMA in the field experiments will arise especially from the fact that the most relevant and common inorganic compounds (i.e. ammonium sulfate, ammonium bisulfate, sodium chloride, iodine tetroxide and iodine pentoxide) do not show growth in the UFO-TDMA when the particle size is 10 nm and ethanol saturation ratio is below 86%. Furthermore, mixed 10 nm particles of ammonium bisulfate and sulfuric acid  $\text{H}_2\text{SO}_4$  mass fractions below 33% do not grow at 85% saturation ratio while atmospherically relevant organic compounds, citric acid, tartaric acid, and benzoic acid do exhibit measurable growth at those conditions.

Naturally, real atmospheric nucleation mode particles can be composed of mixtures of inorganic and organic compounds. It is also possible that inorganic fraction hinders the growth of the organic part in the UFO-TDMA. Furthermore, all organic compounds do not grow in subsaturated ethanol vapor. Therefore, when the UFO-TDMA does not

### Detection of organic fraction using the UFO-TDMA

P. Vaattovaara et al.

Title Page

Abstract

Introduction

Conclusions

References

Tables

Figures

◀

▶

◀

▶

Back

Close

Full Screen / Esc

Print Version

Interactive Discussion

---

**Detection of organic fraction using the UFO-TDMA**P. Vaattovaara et al.

---

[Title Page](#)[Abstract](#)[Introduction](#)[Conclusions](#)[References](#)[Tables](#)[Figures](#)[◀](#)[▶](#)[◀](#)[▶](#)[Back](#)[Close](#)[Full Screen / Esc](#)[Print Version](#)[Interactive Discussion](#)

EGU

show any growth for ambient 10 nm particles, it is not certain that the particles would be purely inorganic. However, in cases where 10 nm ambient particle growth is detected, it can be quite safely concluded that the particles do contain organic matter. The results of Petäjä et al. (2005), for example, showed clear growth for 10 nm particles at ethanol saturation ratio of about 82%. That also proves the usefulness of the UFO-TDMA in studying the composition of nucleation mode sized particles in the field experiments. Thus, we believe that the UFO-TDMA will be an important method to shed light on the nucleation mode particle compositions in different atmospheric conditions.

In the future, laboratory experiments with different organic compounds will be carried out in order to evaluate effects of different functional groups and chain length to growth behavior of organic compounds in nucleation mode sized particles. Furthermore, mixtures of atmospherically relevant organic compounds and inorganic compounds, which are specific to certain field environments, will be carried out in order to describe nucleation mode sized particles also more quantitatively, in addition to the current qualitative analysis.

*Acknowledgements.* This work was supported by EU (European Union) 5th Framework Programme through the QUEST (Quantification of Aerosol Nucleation in the European Boundary Layer) project, Emil Aaltonen Foundation, and Academy of Finland through the Center of Excellence programme.

## References

Boy, M., Kulmala, M., Ruuskanen, T. M., Pihlatie, M., Reissell, A., Aalto, P. P., Keronen, P., Dal Maso, M., Hellen, H., Hakola, H., Jansson, R., Hanke, M., and Arnold, F.: Sulphuric acid closure and contribution to nucleation mode particle growth, *Atmos. Chem. Phys.*, 5, 863–878, 2005,

[SRef-ID: 1680-7324/acp/2005-5-863](#).

Burkholder, J. B., Curtius, J., Ravishankara, A. R., and Lovejoy, E. R.: Laboratory studies of the homogeneous nucleation of iodine oxides, *Atmos. Chem. Phys.*, 4, 19–34, 2004,

[SRef-ID: 1680-7324/acp/2004-4-19](#).

- CRC Handbook of Chemistry and Physics, 77th edition, CRC press, Inc., 1996.
- Creac'h, P. V.: Presence of citric and malic acids in littoral marine waters, *Hebd. Seances Acad. Sci.*, 240, 2551–2553, 1955.
- Daehlie, G. and Kjekshus, A.: Iodine oxides, Part I, *Acta Chem. Scand.*, 18, 144–156, 1964.
- 5 Fiedler, V., Dal Maso, M., Boy, M., Aufmhoff, H., Hoffmann, J., Schuck, T., Birmili, W., Arnold, F., and Kulmala, M.: The contribution of sulphuric acid to atmospheric particle formation and growth: a comparison between boundary layers in Northern and Central Europe, *Atmos. Chem. Phys. Discuss.*, 5, 573–605, 2005,  
[SRef-ID: 1680-7375/acpd/2005-5-573](#).
- 10 Hamilton, J. F., Webb, P. J., Webb, A. C., Lewis, A. C., Hopkins, J. R., Smith, S., and Davy, P.: Partially oxidized organic components in urban aerosol using GCXGX-TOF/MS, *Atmos. Chem. Phys.*, 4, 1279–1290, 2004,  
[SRef-ID: 1680-7324/acp/2004-4-1279](#).
- Ibald-Mulli, A., Wichmann, H. E., Kreyling, W., and Peters, A.: Epidemiological evidence on health effects of ultrafine particles, *J. Aerosol Med.*, 15 (2), 189–201, 2002.
- 15 Joutsensaari, J., Vaattovaara, P., Vesterinen, M., Hämeri, K., and Laaksonen, A.: A novel tandem differential mobility analyzer with organic vapor treatment of aerosol particles, *Atmos. Chem. Phys.*, 1, 51–60, 2001,  
[SRef-ID: 1680-7324/acp/2001-1-51](#).
- 20 Joutsensaari, J., Toivonen, T., Vaattovaara, P., Vesterinen, M., Vepsäläinen, J., and Laaksonen, A.: Time-resolved growth behavior of acid aerosols in ethanol vapor with a tandem-DMA technique, *J. Aerosol Sci.*, 35, 851–867, 2004.
- Knutson, E. O. and Whitby, K. T.: Aerosol classification by electric mobility: apparatus, theory and applications, *J. Aerosol Sci.*, 6, 443–451, 1975.
- 25 Kulmala, M.: How particles nucleate and grow, *Science*, 307 (5647), 1000–1001, 2003.
- Kulmala, M., Vehkamäki, H., Petäjä, T., Dal Maso, M., Lauri, A., Kerminen, V.-M., Birmili, W., and McMurry, P. H.: Formation and growth rates of ultrafine atmospheric particles: A review of observations, *J. Aerosol Sci.*, 35, 2, 143–176, 2004.
- Laaksonen, A., Talanquer, V., and Oxtoby, D. W.: Nucleation-measurements, theory, and atmospheric applications, *Ann. Rev. Phys. Chem.*, 46, 489–524, 1995.
- 30 Mäkelä, J., Aalto, P., Jokinen, V., Pohja, T., Nissinen, A., Palmroth, S., Markkanen, T., Seitsonen, K., Lihavainen, H., and Kulmala, M.: Observations of ultrafine aerosol particle formation and growth in boreal forest, *Geophys. Res. Lett.*, 24, 1219–1222, 1997.

---

**Detection of organic fraction using the UFO-TDMA**P. Vaattovaara et al.

---

[Title Page](#)[Abstract](#)[Introduction](#)[Conclusions](#)[References](#)[Tables](#)[Figures](#)[◀](#)[▶](#)[◀](#)[▶](#)[Back](#)[Close](#)[Full Screen / Esc](#)[Print Version](#)[Interactive Discussion](#)

**Detection of organic fraction using the UFO-TDMA**

P. Vaattovaara et al.

Title Page

Abstract

Introduction

Conclusions

References

Tables

Figures

◀

▶

◀

▶

Back

Close

Full Screen / Esc

Print Version

Interactive Discussion

McFiggans, G., Coe, H., Burgess, R., Allan, J., Cubison, M., Alfarra, R., Saunders, R., Saiz-Lopez, A., Plane, J. M. C., Wevill, D., Carpenter, L., Richard, A. R., and Monks, P. S.: Direct evidence for coastal iodine particles from *Laminaria* macroalgae – linkage to emissions of molecular iodine, *Atmos. Chem. Phys.*, 4, 701–713, 2004,

[SRef-ID: 1680-7324/acp/2004-4-701](#).

Mertes, S., Schröder, F., and Wiedensohler, A.: The particle detection efficiency curve of the TSI-3010 CPC as a function of temperature difference between saturator condenser, *Aerosol Sci. Technol.*, 23, 257–261, 1995.

Ming, Y. and Russell, L.: Predicted hygroscopic growth of sea salt aerosol, *J. Geophys. Res.*, 106, 28 259–28 274, 2001.

O'Dowd, C. D., Facchini, M. C., Cavalli, F., Ceburnis, D., Mircea, M., Dececari, S., Fuzzi, S., Yoon, Y. J., and Putaud, J.-P.: Biogenically driven organic contribution to marine aerosol, *Nature*, 431, 676–680, 2004.

Petäjä, T., Kerminen, V.-M., Hämeri, K., Vaattovaara, P., Joutsensaari, J., Junkermann, W., Laaksonen, A., and Kulmala, M.: Effects of SO<sub>2</sub> oxidation on ambient aerosol growth in water and ethanol vapours, *Atmos. Chem. Phys.*, 5, 767–779, 2005,

[SRef-ID: 1680-7324/acp/2005-5-767](#).

Putaud, J.-P., Van Dingenen, R., Dell'Acqua, A., Raes, F., Matta, E., Descesari, S., Facchini, M. C., and Fuzzi, S.: Size-segregated aerosol mass closure and chemical composition in Monte Cimone (I) during MINATROC, *Atmos. Chem. Phys.*, 4, 889–902, 2004,

[SRef-ID: 1680-7324/acp/2004-4-889](#).

Quant, F. R., Caldow, R., Sem, G. J., and Addison, T. J.: Performance of condensation particle counters with three continuous flow design, *J. Aerosol. Sci.*, 23, 405–408, 1992.

Reischl, G. P.: Measurement of ambient aerosols by the different mobility analyzer method: concepts and realization criteria for the size range between 2 and 500 nm, *Aerosol Sci. Technol.*, 14, 5–24, 1991.

Röhrl, A. and Lammel, G.: Determination of malic and other C<sub>4</sub> dicarboxylic acids in atmospheric aerosol samples, *Chemosphere*, 46, 1195–1199, 2002.

Sanfeld, A., Sefiane, K., Benielli, D., and Steinchen, A.: Does capillarity influence chemical reaction in drops and bubbles? A thermodynamic approach, *Adv. Colloid Interface Sci.*, 86, 153–193, 2000.

Sanfeld, A. and Steinchen, A.: Does the size of small objects influence chemical reactivity in living systems, *C. R. Biologies*, 326, 141–147, 2003.

Seinfeld, J. and Pandis, S.: Atmospheric chemistry and physics: from air pollution to climate change, John Wiley & Sons, Inc., New York, 1998.

Slingo, A.: Sensitivity of the Earth's radiation budget to changes in low clouds, *Nature*, 343, 49–51, 1990.

5 Vehkamäki, H., Napari, I., Kulmala, M., and Noppel, M.: Stable ammonium bisulphate clusters in the atmosphere, *Phys. Rev. Lett.*, 93, 148 501–148 504, 2004.

Winklmayr, W., Reischl, G. P., Lindner, A. O., and Berner, A.: A new electromobility spectrometer for the measurement of aerosol size distributions in the size range from 1 to 1000 nm, *J. Aerosol Sci.*, 22, 289–296, 1991.

10

---

**Detection of organic  
sulfates using the  
UFO-TDMA**

P. Vaattovaara et al.

---

Title Page

Abstract

Introduction

Conclusions

References

Tables

Figures

◀

▶

◀

▶

Back

Close

Full Screen / Esc

Print Version

Interactive Discussion

**Table 1.** Manufacturer, mole mass (g/mol), density (g/cm<sup>3</sup>), purity (%) and precursor solution concentration (mol/L) information for compounds studied in this work by the UFO-TDMA. The superscripts <sup>1</sup> and <sup>2</sup> mean CRC Handbook of Chemistry and Physics (1996) and this work, respectively.

Compounds	Manufacturer	M (g/mol)	Density (g/cm <sup>3</sup> )	Purity (%)	Conc. (mol/L)
I <sub>2</sub> O <sub>4</sub> Iodine tetroxide	selfmade <sup>2</sup>	317.80	4.20 <sup>1</sup>	Raman checked	0.05 0.002
I <sub>2</sub> O <sub>5</sub> Iodine pentoxide	Merck	333.80	4.98	>99	0.01
(NH <sub>4</sub> ) <sub>2</sub> SO <sub>4</sub> Ammonium sulfate	FF-Chemicals	132.14	1.77	>99	0.01
(NH <sub>4</sub> )HSO <sub>4</sub> Ammonium bisulfate	Fluka	115.11	1.78	>99	0.01
NaCl Sodium chloride	FF-Chemicals	58.44	2.17	99.8	0.01
NH <sub>4</sub> NO <sub>3</sub> Ammonium nitrate	Sigma	80.04	1.72	99.5	0.63
C <sub>6</sub> H <sub>8</sub> O <sub>7</sub> ·H <sub>2</sub> O Citric acid·H <sub>2</sub> O	Fisher Chemicals	210.14	1.665	99.9	0.01
C <sub>4</sub> H <sub>6</sub> O <sub>6</sub> L(+)-tartaric acid	Aldrich	150.09	1.76	99.5	0.01
C <sub>7</sub> H <sub>6</sub> O <sub>2</sub> Benzoic acid	Aldrich	122.12	1.27	99	0.01
H <sub>2</sub> SO <sub>4</sub> Sulfuric acid	Riedel-de Haën	98.08	1.84	95–97	–

## Detection of organic fraction using the UFO-TDMA

P. Vaattovaara et al.

Title Page

Abstract

Introduction

Conclusions

References

Tables

Figures

◀

▶

◀

▶

Back

Close

Full Screen / Esc

Print Version

Interactive Discussion

EGU



## Detection of organic fraction using the UFO-TDMA

P. Vaattovaara et al.

**Table 2.** Mass fractions (m%) and concentrations (mol/L) of the aqueous precursor solutions for mixtures of sulfuric and ammonium bisulfate.

Mixtures	m%	Conc. (mol/L)	m%	Conc. (mol/L)	m%	Conc. (mol/L)	m%	Conc. (mol/L)
H <sub>2</sub> SO <sub>4</sub> +	18	0.54	25	0.63	33	0.51	50	1.03
NH <sub>4</sub> HSO <sub>4</sub>	82	2.07	75	1.55	67	0.87	50	0.87

Title Page

Abstract

Introduction

Conclusions

References

Tables

Figures

◀

▶

◀

▶

Back

Close

Full Screen / Esc

Print Version

Interactive Discussion

EGU

## Detection of organic fraction using the UFO-TDMA

P. Vaattovaara et al.

Title Page

Abstract

Introduction

Conclusions

References

Tables

Figures

◀

▶

◀

▶

Back

Close

Full Screen / Esc

Print Version

Interactive Discussion

EGU

**Table 3.** Ethanol saturation, water solubility, ethanol solubility and ethanol growth information for particles (6–50 nm) composed of individual compounds. The superscripts <sup>1</sup> and <sup>2</sup> mean CRC Handbook of Chemistry and Physics (1996) and this work, respectively.

individual compounds	S (%)	sol. H <sub>2</sub> O <sup>1</sup>	sol. EtOH <sup>1</sup>	growth EtOH <sup>2</sup>
I <sub>2</sub> O <sub>4</sub> , iodine tetroxide	86 84	slightly soluble	insoluble <sup>2</sup>	no
I <sub>2</sub> O <sub>5</sub> , iodine pentoxide	86	soluble	insoluble	no
(NH <sub>4</sub> ) <sub>2</sub> SO <sub>4</sub> , ammonium sulfate	86	very soluble	insoluble	no
(NH <sub>4</sub> )HSO <sub>4</sub> , ammonium bisulfate	86	very soluble	insoluble	yes/no
NaCl, sodium chloride	86	soluble	slightly soluble	no
NH <sub>4</sub> NO <sub>3</sub> , ammonium nitrate	84	very soluble	–	volatile
C <sub>6</sub> H <sub>8</sub> O <sub>7</sub> , citric acid·H <sub>2</sub> O	85	very soluble	very soluble	yes
C <sub>4</sub> H <sub>6</sub> O <sub>6</sub> , tartaric acid	85	soluble	soluble	yes
C <sub>7</sub> H <sub>6</sub> O <sub>2</sub> , benzoic acid	85	slightly soluble	very soluble	yes

## Detection of organic fraction using the UFO-TDMA

P. Vaattovaara et al.

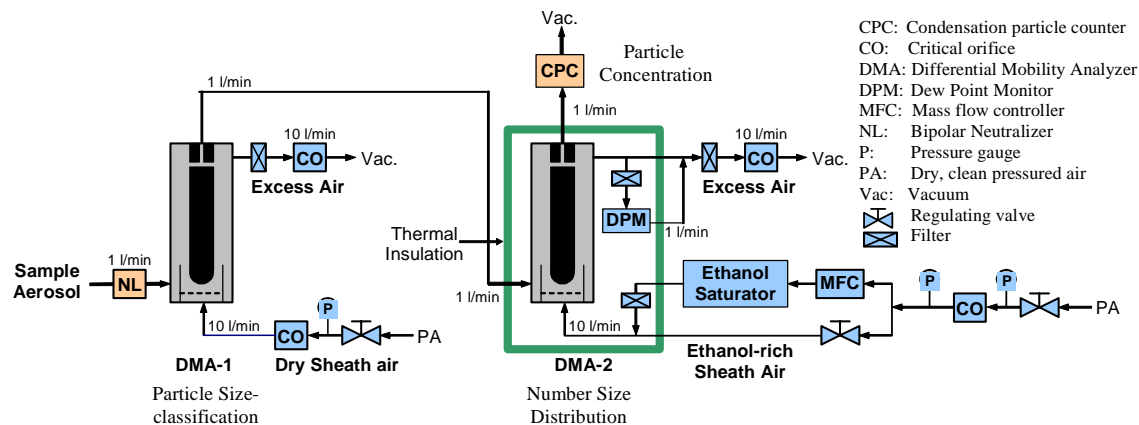

Fig. 1. A schematic picture of the UFO-TDMA system.

Title Page

Abstract

Introduction

Conclusions

References

Tables

Figures

◀

▶

◀

▶

Back

Close

Full Screen / Esc

Print Version

Interactive Discussion

EGU

**Detection of organic  
fraction using the  
UFO-TDMA**

P. Vaattovaara et al.

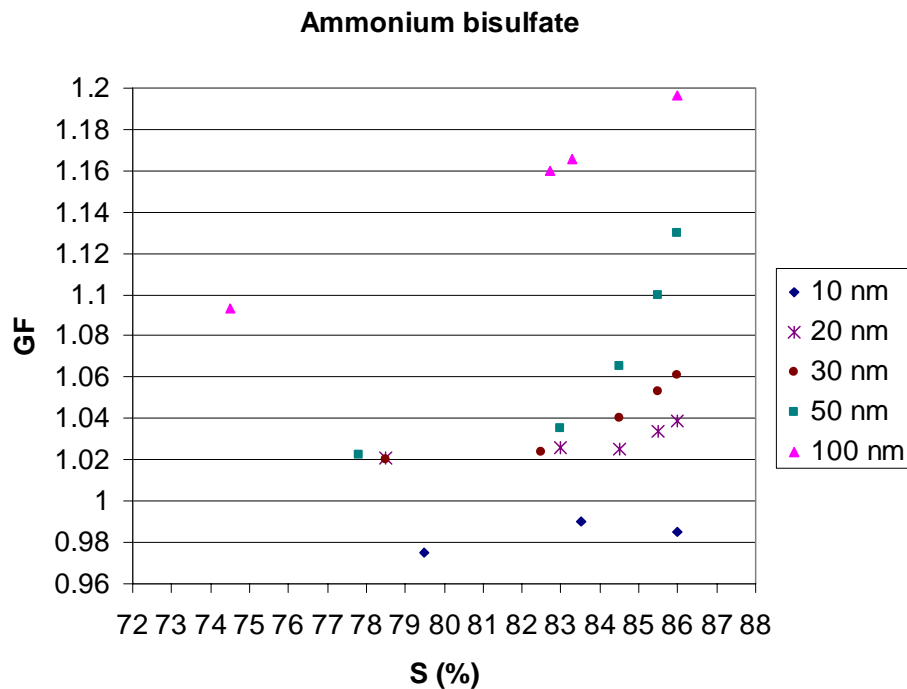

**Fig. 2.** Growth factors (GFs) of ultrafine (10, 20, 30 and 50 nm, respectively) ammonium bisulfate particles as a function of ethanol saturation (S%). Also GFs for 100 nm ammonium bisulfate particles (Joutsensaari et al., 2004) are shown in the figure.

[Title Page](#)[Abstract](#)[Introduction](#)[Conclusions](#)[References](#)[Tables](#)[Figures](#)[◀](#)[▶](#)[◀](#)[▶](#)[Back](#)[Close](#)[Full Screen / Esc](#)[Print Version](#)[Interactive Discussion](#)

EGU

**Detection of organic  
fraction using the  
UFO-TDMA**

P. Vaattovaara et al.

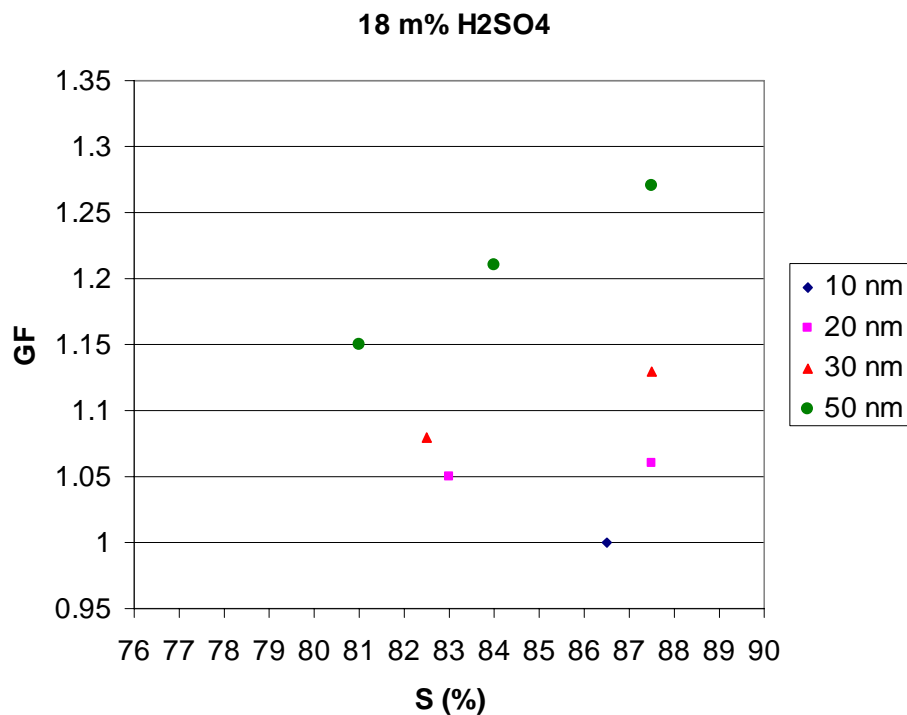

**Fig. 3.** Growth factors (GFs) of ultrafine particles (10, 20, 30 and 50 nm, respectively) with sulfuric acid mass fraction of 18% as a function of ethanol saturation S(%).

[Title Page](#)[Abstract](#)[Introduction](#)[Conclusions](#)[References](#)[Tables](#)[Figures](#)[◀](#)[▶](#)[◀](#)[▶](#)[Back](#)[Close](#)[Full Screen / Esc](#)[Print Version](#)[Interactive Discussion](#)

EGU

**Detection of organic  
fraction using the  
UFO-TDMA**

P. Vaattovaara et al.

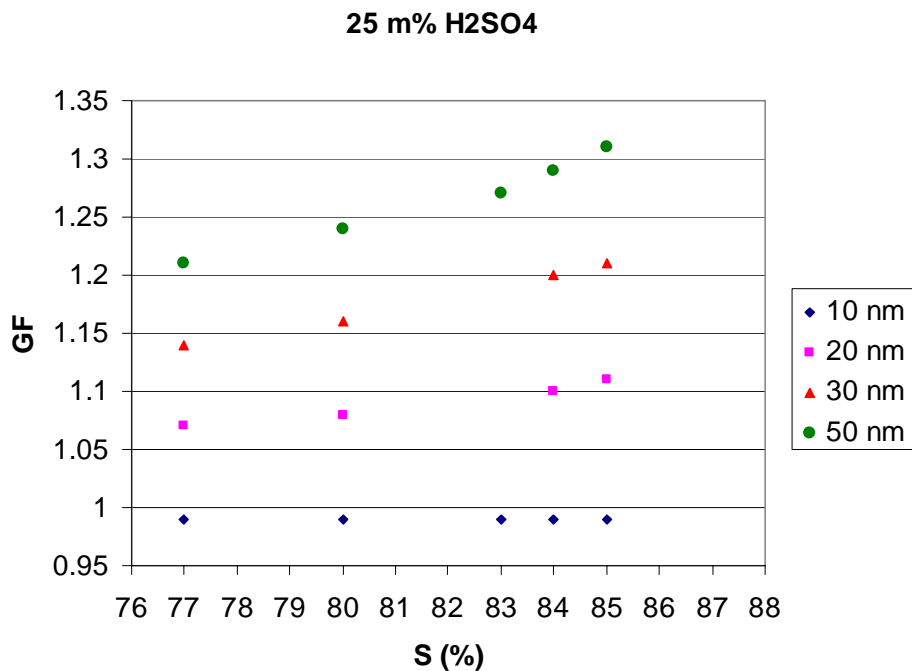

**Fig. 4.** Growth factors (GFs) of ultrafine particles (10, 20, 30 and 50 nm, respectively) with sulfuric acid mass fraction of 25% as a function of ethanol saturation S(%).

[Title Page](#)[Abstract](#)[Introduction](#)[Conclusions](#)[References](#)[Tables](#)[Figures](#)[◀](#)[▶](#)[◀](#)[▶](#)[Back](#)[Close](#)[Full Screen / Esc](#)[Print Version](#)[Interactive Discussion](#)

EGU

**Detection of organic  
fraction using the  
UFO-TDMA**

P. Vaattovaara et al.

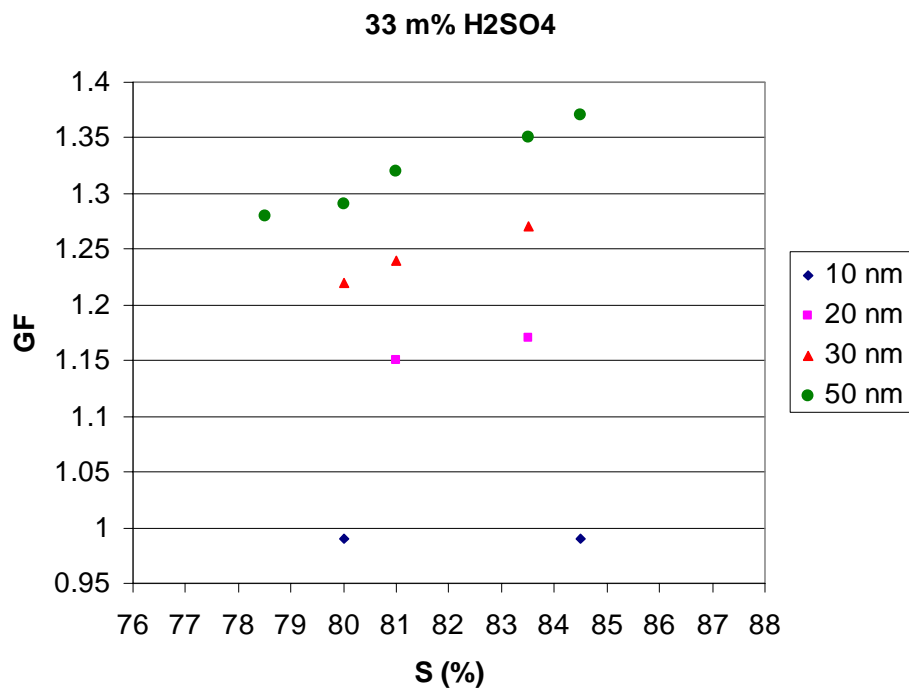

**Fig. 5.** Growth factors (GFs) of ultrafine particles (10, 20, 30 and 50 nm, respectively) with sulfuric acid mass fraction of 33% as a function of ethanol saturation S(%).

[Title Page](#)[Abstract](#)[Introduction](#)[Conclusions](#)[References](#)[Tables](#)[Figures](#)[◀](#)[▶](#)[◀](#)[▶](#)[Back](#)[Close](#)[Full Screen / Esc](#)[Print Version](#)[Interactive Discussion](#)

EGU

**Detection of organic  
fraction using the  
UFO-TDMA**

P. Vaattovaara et al.

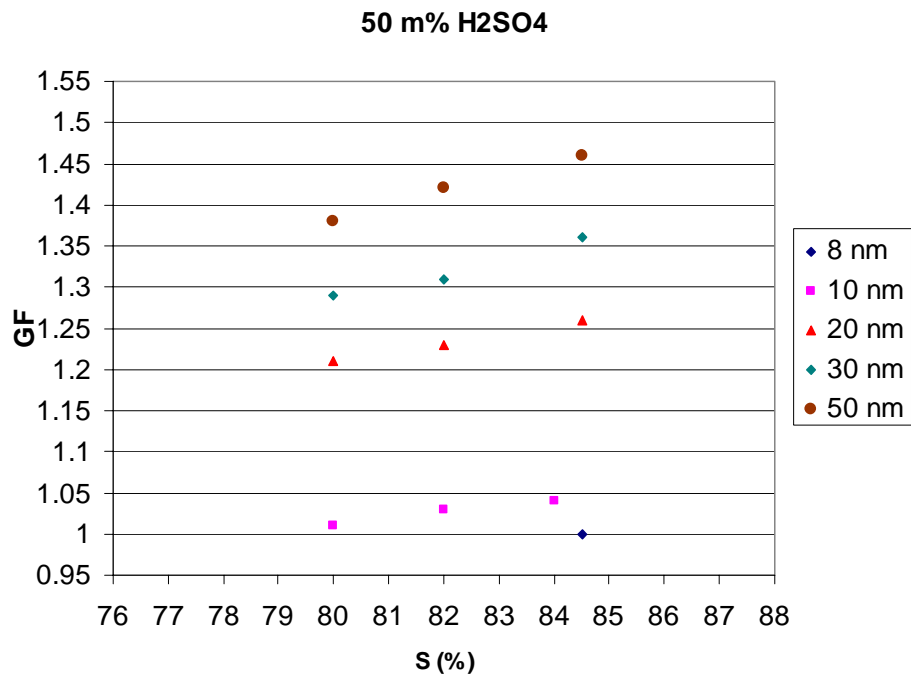

**Fig. 6.** Growth factors (GFs) of ultrafine (8, 10, 20, 30 and 50 nm, respectively) particles with sulfuric acid mass fraction of 50% as a function of ethanol saturation S(%).

[Title Page](#)[Abstract](#)[Introduction](#)[Conclusions](#)[References](#)[Tables](#)[Figures](#)[◀](#)[▶](#)[◀](#)[▶](#)[Back](#)[Close](#)[Full Screen / Esc](#)[Print Version](#)[Interactive Discussion](#)

EGU



**Detection of organic  
fraction using the  
UFO-TDMA**

P. Vaattovaara et al.

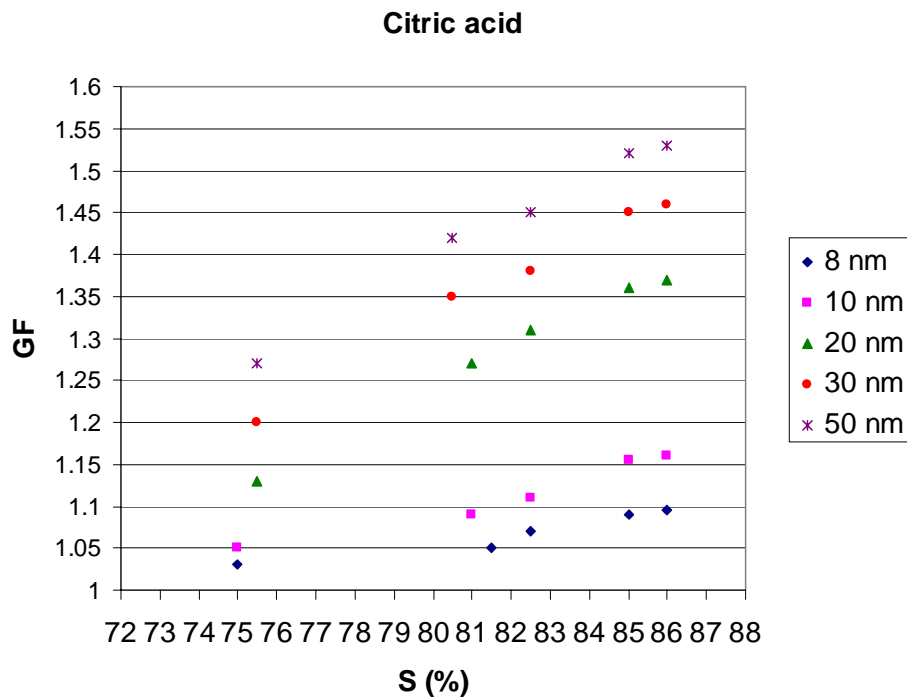

**Fig. 7.** Growth factors (GFs) of ultrafine (8, 10, 20, 30 and 50 nm, respectively) citric acid particles as a function of ethanol saturation (S%).

[Title Page](#)[Abstract](#)[Introduction](#)[Conclusions](#)[References](#)[Tables](#)[Figures](#)[◀](#)[▶](#)[◀](#)[▶](#)[Back](#)[Close](#)[Full Screen / Esc](#)[Print Version](#)[Interactive Discussion](#)

EGU

Detection of organic  
fraction using the  
UFO-TDMA

P. Vaattovaara et al.

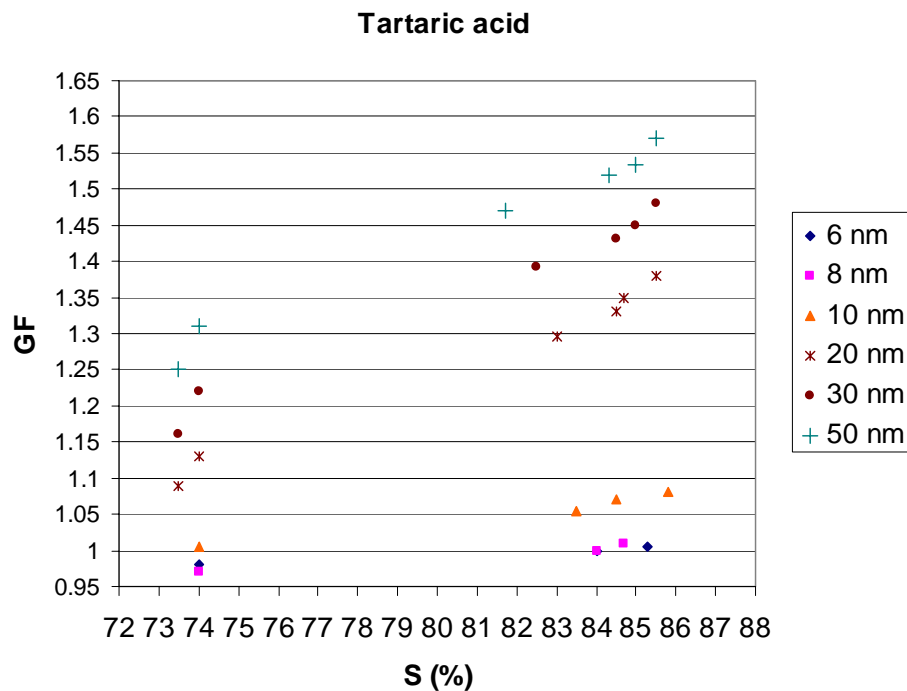

**Fig. 8.** Growth factors (GFs) of ultrafine (6, 8, 10, 20, 30 and 50 nm, respectively) tartaric acid particles as a function of ethanol saturation (S%).

[Title Page](#)[Abstract](#)[Introduction](#)[Conclusions](#)[References](#)[Tables](#)[Figures](#)[◀](#)[▶](#)[◀](#)[▶](#)[Back](#)[Close](#)[Full Screen / Esc](#)[Print Version](#)[Interactive Discussion](#)

EGU

Detection of organic  
fraction using the  
UFO-TDMA

P. Vaattovaara et al.

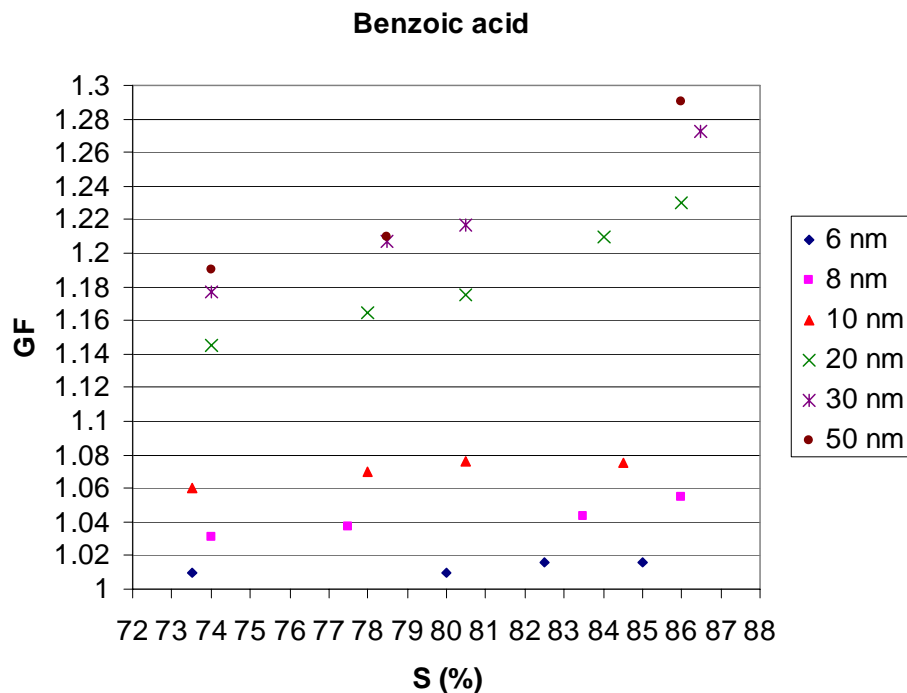

**Fig. 9.** Growth factors (GFs) of ultrafine (6, 8, 10, 20, 30 and 50 nm, respectively) benzoic acid particles as a function of ethanol saturation (S%).

[Title Page](#)[Abstract](#)[Introduction](#)[Conclusions](#)[References](#)[Tables](#)[Figures](#)[◀](#)[▶](#)[◀](#)[▶](#)[Back](#)[Close](#)[Full Screen / Esc](#)[Print Version](#)[Interactive Discussion](#)

EGU