



HAL
open science

Soils apart from equilibrium? consequences for soil carbon balance modelling

T. Wutzler, M. Reichstein

► **To cite this version:**

T. Wutzler, M. Reichstein. Soils apart from equilibrium? consequences for soil carbon balance modelling. Biogeosciences Discussions, 2006, 3 (5), pp.1679-1714. hal-00297852

HAL Id: hal-00297852

<https://hal.science/hal-00297852>

Submitted on 18 Jun 2008

HAL is a multi-disciplinary open access archive for the deposit and dissemination of scientific research documents, whether they are published or not. The documents may come from teaching and research institutions in France or abroad, or from public or private research centers.

L'archive ouverte pluridisciplinaire **HAL**, est destinée au dépôt et à la diffusion de documents scientifiques de niveau recherche, publiés ou non, émanant des établissements d'enseignement et de recherche français ou étrangers, des laboratoires publics ou privés.

Biogeosciences Discussions is the access reviewed discussion forum of *Biogeosciences*

**Soils apart
equilibrium
modelling**

T. Wutzler and
M. Reichstein

Soils apart from equilibrium – consequences for soil carbon balance modelling

T. Wutzler and M. Reichstein

Max Plank Institute for Biogeochemistry, Jena, Germany

Received: 28 August 2006 – Accepted: 5 October 2006 – Published: 10 October 2006

Correspondence to: T. Wutzler (twutz@bgc-jena.mpg.de)

Title Page

Abstract

Introduction

Conclusions

References

Tables

Figures

⏪

⏩

◀

▶

Back

Close

Full Screen / Esc

Printer-friendly Version

Interactive Discussion

Abstract

Many projections of the soil carbon sink or source are based on kinetically defined carbon pool models. Parameters of these models are often determined in a way that the steady state of the model matches observed carbon stocks. The underlying simplifying assumption is that observed carbon stocks are near equilibrium. This assumption is challenged by observations of very old soils that do still accumulate carbon. In this modelling study we explored the consequences of the case where soils are apart from equilibrium. Calculation of equilibrium states of soils that are currently accumulating small amounts of carbon were performed using the Yasso model. It was found that already very small current accumulation rates cause big changes in theoretical equilibrium stocks, which can virtually approach infinity. We conclude that soils that have been disturbed several centuries ago are not in equilibrium but in a transient state because of the slowly ongoing accumulation of the slowest pool. A first consequence is that model calibrations to current carbon stocks that assume equilibrium state, overestimate the decay rate of the slowest pool. A second consequence is that spin-up runs (simulations until equilibrium) overestimate stocks of recently disturbed sites. In order to account for these consequences, we propose a transient correction. This correction prescribes a lower decay rate of the slowest pool and accounts for disturbances in the past by decreasing the spin-up-run predicted stocks to match an independent estimate of current soil carbon stocks. Application of this transient correction at a Central European beech forest site with a typical disturbance history resulted in an additional carbon fixation of $5.7 \pm 1.5 \text{ tC/ha}$ within 100 years. Carbon storage capacity of forest soils is potentially much higher than currently assumed. Simulations that do not adequately account for the transient state of soil carbon stocks neglect a substantial amount of current carbon accumulation.

BGD

3, 1679–1714, 2006

Soils apart equilibrium modelling

T. Wutzler and
M. Reichstein

Title Page

Abstract

Introduction

Conclusions

References

Tables

Figures

◀

▶

◀

▶

Back

Close

Full Screen / Esc

Printer-friendly Version

Interactive Discussion

1 Introduction

The widely applied soil carbon models Century (e.g. Parton et al., 1988), Roth-C (Jenkinson, 1990), Romul (Chertov et al., 2001), Yasso (Liski et al., 2005) and many other models are based on kinetically defined pools. This means, that decomposition is described by removing a constant fraction of a pool at each time step. This fraction, which distinguishes the pools, is called the decay rate or decomposition rate and is modeled with a dependence on environmental conditions, in most cases temperature and moisture. Despite simplifying many soil processes, these models have proven to predict reasonable soil carbon stock changes during decadal time scales (e.g. Smith et al., 1997). However, there is a controversy whether the decay rates of the slower (more stable) pools have a lower, equal or higher dependence to warming than the faster pool (Ågren, 2000; Davidson and Janssens, 2006). The different answers to this question cause large differences in the long term soil carbon sink or source. While the decay rates of the faster pools have been determined by experimental results, the decay rates of the slower pools have been calibrated in a way that a models steady states matches observed carbon stocks (e.g. Liski et al., 2005). The underlying assumption is that the observed carbon stocks represent equilibrium stocks. This assumption also allows a determination of the initial state of the model for given constant average inputs and parameters by simulating the model until an equilibrium state is reached (spin-up-runs) (e.g. Smith et al., 2005). However, observed soils might be far away from equilibrium because of possible very long turnover times of stable compounds and disturbances by fire, erosion, land use or land use change. The equilibrium assumption is challenged by observations of steadily increasing carbon stocks of very old soils. Wardle et al. (1997) observed carbon stocks of about 240 tC/ha in the organic layer on small islands in northern Sweden, where fire was prevented. Sizes of the stocks correlate with the time since last disturbance (1000 to 3000 years). This implies increasing stocks at old soils. Many modellers argue that the equilibrium assumption might be wrong, but it works and must be used until other approaches are evolving. Nevertheless, the

BGD

3, 1679–1714, 2006

Soils apart equilibrium modelling

T. Wutzler and
M. Reichstein

Title Page

Abstract

Introduction

Conclusions

References

Tables

Figures

⏪

⏩

◀

▶

Back

Close

Full Screen / Esc

Printer-friendly Version

Interactive Discussion

consequences of relaxing the equilibrium assumptions are not well understood.

The aim of this study was to explore the consequences of a relaxed equilibrium assumption. The paper has the following outline. In a first part we perform an equilibrium experiment using the Yasso model's standard parameterization and show that the decay rate of the slowest pool and theoretical equilibrium stocks are highly uncertain. This implies that soil might be far apart from theoretical equilibrium yet. Based on these findings we propose a method how to initialize models to a transient state instead of equilibrium. In a second part we apply this initialization to a Central European case study. We discuss consequences for current soil modelling. Further, we show and discuss ways to overcome the equilibrium assumption.

2 Methods

2.1 The Yasso model

The soil carbon model Yasso was designed by Liski et al. (2005) in order to model soil carbon stocks of mineral soils in managed forests. Despite its simplicity and low demands on input data and parameters it shares many properties of the family of models that are based on kinetically defined pools. Figure 1 displays the model structure and the flow of carbon. The right part describes the separation of the different litter types into compartments that correspond to the kinetically defined pools and it describes a delay of the woody litter compartments before decomposers can attack the chemical compounds. The left part describes the decomposition of the chemical compounds. The decay rates are dependent on mean annual temperature (or alternatively effective temperature sum) and a drought index (difference between precipitation and potential evapotranspiration during vegetation period). In the standard parameterization the decay rates of the slower pools are less sensitive to temperature increase than the fast pools (humus one: 60%, humus two: 36% of sensitivity of fast pools). The model has been tested and successfully applied to boreal forest (Peltoniemi et al., 2004), litter

BGD

3, 1679–1714, 2006

Soils apart equilibrium modelling

T. Wutzler and
M. Reichstein

Title Page

Abstract

Introduction

Conclusions

References

Tables

Figures

◀

▶

◀

▶

Back

Close

Full Screen / Esc

Printer-friendly Version

Interactive Discussion

bag studies in Canada (Palosuo et al., 2005), and as part of the CO2FIX model all over Europe (e.g. Kaipainen et al., 2004; e.g. Nabuurs and Schelhaas, 2002).

2.2 The relaxed equilibrium assumption

The relaxed equilibrium assumption corresponded to the usual equilibrium assumption, except that the slowest pool was excluded from this assumption. Assuming that time since last disturbance is longer than a century and that the inputs to the soil system did not change much within this time, the faster pools (turnover times of at most decadal time scale) have had enough time to recover from former disturbance. They were regarded to be near a dynamic equilibrium (averaging across changes during rotation periods and with climate fluctuations). The relaxed equilibrium assumption assumed that this is not true for the slowest pool which needs long time scales to reach the theoretical equilibrium. Hence is assumed the slowest pool to be still accumulating (Table 1). If all the faster pools are in equilibrium, the input rate to the slowest pool is constant (Fig. 2).

2.3 Equilibrium experiment

Using this relaxed equilibrium assumption we determined the decay rates of the slowest pool of soils that are recovering from former disturbance. The slowest pool was described by a first order kinetics with input (Eq. 1). When applying a constant input rate, integration of Eq. (1) resulted in the closed form of Eq. (2). Equation (3) was derived from Eq. (2) by constraining the stock at time $t=0$. The decay rate was determined as a function of the current stock and its current rate of assimilation (Eq. 4) by resolving Eq. (1) for the decay rate.

$$\frac{\delta C}{\delta t} = i - k \cdot C \quad (1)$$

$$C = \frac{i}{k} \left(1 - ae^{-k \cdot t} \right) \quad (2)$$

Soils apart equilibrium modelling

T. Wutzler and
M. Reichstein

Title Page

Abstract

Introduction

Conclusions

References

Tables

Figures

◀

▶

◀

▶

Back

Close

Full Screen / Esc

Printer-friendly Version

Interactive Discussion

$$C = \frac{i}{k} - \left(\frac{i}{k} - C_0 \right) \cdot e^{-k \cdot t} \quad (3)$$

$$k = \frac{i - \frac{\Delta C_c}{\Delta t}}{C_c} \quad (4)$$

$$C_e = \frac{i}{k} \quad (5)$$

$$t_{95} = \frac{\ln(0.05 \cdot C_e)}{k} \quad (6)$$

5 C : stock; t : time; i : input rate (amount / time); k : decay rate; a : integration constant; C_0 : stock; at $t=0$; C_c : current stock; $\Delta C_c / \Delta t$: current stock change rate (approximation of $\delta C / \delta t$); C_e : asymptote of Eq. (2) representing the theoretical equilibrium stock; t_{95} : accumulation time: time for increase of stocks from zero to 95% of equilibrium stock

10 In the equilibrium experiment we prescribed different current assimilation rates and calculated corresponding decay rates of the slowest pool (Eq. 4). Given these decay rates, we determined equilibrium stocks (Eq. 5), and the times that are needed to accumulate 95% of these stocks (Eq. 6). Initial pools size (40.7 t/ha) and input to the slowest pool ($i=0.063$ tC/ha/yr) were calculated by equilibrium of the faster pools of the Yasso model with standard parameterization for Norway spruce in standard climate
 15 (Appendix B). Reasonable constant average litter inputs of Norway spruce were applied (non woody litter=1.7 tC/ha/yr, fine woody litter=1.4 tC/ha/yr, thin coarse woody litter=0.1 tC/ha/yr, large coarse woody litter=0.1 tC/ha/yr). Additionally, calculations were repeated using an increased input to the slow pool ($i=0.127$ tC/ha/yr) that resulted from a change in the Yasso parameterization in which a larger part of decay
 20 material was spent to form more recalcitrant compounds ($p_{lig}=p_{hum1}=0.4$).

**Soils apart
equilibrium
modelling**

T. Wutzler and
M. Reichstein

Title Page

Abstract

Introduction

Conclusions

References

Tables

Figures

◀

▶

◀

▶

Back

Close

Full Screen / Esc

Printer-friendly Version

Interactive Discussion

2.4 The transient correction

In continuation of the results of the equilibrium experiment we developed a method of correcting spin-up-run predicted pool sizes for the effects of former disturbance (over-estimation of slowest pool's decay rate in model calibration and slowest pool being apart from equilibrium). This "transient correction" is only valid for sites that have not been disturbed for about a century, because it uses the relaxed equilibrium assumption (all pools are in equilibrium except the slowest pool). The correction, first, prescribes a lower decay rate of the slowest pool. Below it will be shown that about 20% of the decay rate that is determined by the usual equilibrium assumption is appropriate for century term simulations. Second, the correction decreases the spin-up-run predicted stock of the slowest pool (which will be large due to the lower decay rate) in a way that the sum of the stocks of the soil carbon pools matches an independent estimate of current carbon stocks.

2.5 Application of the transient correction

We applied the transient correction at a Central European beech forest chronosequence (Mühlhausen/Leinefelde), which has been managed as a shelterwood system. In the EU-project FORCAST, litter fall, organic layer carbon stocks, and soil carbon stocks have been measured (Mund, 2004). Carbon pools of the soil model were initialized with spin up runs with constant average litter inputs and climatic conditions (mean average temperature: 6.8°C, drought index: 71.3 mm). The sites of the chronosequence have been disturbed by wood pasture about 150 years ago and some sites have been possibly used as agricultural land before the 16th century. As independent estimate of soil carbon stocks for the transient correction the sum of the measured carbon stocks of the mineral soil ($41.7 \pm 5.0 \text{ tC/ha}$) and the organic layer ($3.7 \pm 0.8 \text{ tC/ha}$) was used. In order to maintain comparability across scenarios we did not vary litter inputs with stand age but applied constant litter inputs that were averaged across one rotation cycle. The used standard parameterization is listed in Appendix B. In 4 sce-

BGD

3, 1679–1714, 2006

Soils apart equilibrium modelling

T. Wutzler and
M. Reichstein

Title Page

Abstract

Introduction

Conclusions

References

Tables

Figures

◀

▶

◀

▶

Back

Close

Full Screen / Esc

Printer-friendly Version

Interactive Discussion

nario groups (Table 2) we studied the sensitivity of carbon stock changes to the decay rate of the hum2 pool (slowest most stable pool of the Yasso model). Within each group, the decay rate was varied by dividing the standard value of 0.0012 yr^{-1} by 1, 5, 25, 125, and 625. Table 3 lists average litter inputs to the Yasso model, for details of its derivation see Appendix A. Additionally, we repeated all the sensitivity study in four scenario groups that differed from the corresponding previous four groups by increased climate sensitivity of the slow pools. Increased climate sensitivity was parameterized in a way that the decay rates of the slow pools were as sensitive to warming as the decay rates of fast pools ($s_1=s_2=100\%$).

3 Results

3.1 Highly uncertain decay rates and equilibrium stocks

Soils carbon stocks that are far from equilibrium had a lower decay rate of the slowest pool and a larger current carbon accumulation rate with the relaxed equilibrium assumption (Fig. 3). The assumption of already very small current accumulation rates in the equilibrium experiment resulted in large changes in the theoretical equilibrium stocks and the times that are needed to accumulate these stocks (Fig. 4). If the assumed rate of change was approaching the input rate to the slowest pool, the difference between input and accumulation approached zero. Hence, the decay rate also approached zero. This caused the equilibrium stocks and the times to reach these stocks to approach infinity. The limit case, when the rate of change was equal to the input, corresponded to an inert pool that is not decomposed. Still with big changes to the model (doubling the proportion of carbon that is used to form more recalcitrant components $p_{lig}=p_{hum1}=0.4$), the limit case had a different position but the pattern was the same: small current accumulation rates had a large effect on theoretical equilibrium pools (Fig. 4 cross symbols).

Soils apart equilibrium modelling

T. Wutzler and
M. Reichstein

Title Page

Abstract

Introduction

Conclusions

References

Tables

Figures

⏪

⏩

◀

▶

Back

Close

Full Screen / Esc

Printer-friendly Version

Interactive Discussion

3.2 Additional carbon accumulation when accounting for former disturbance

The sum of the carbon pools after the spin-up-run exceeded observed stocks by about 30% for the Mühlhausen/Leinefelde study site that has been disturbed until 150 years ago (Fig. 5). With the relaxed equilibrium assumption (all pools are in equilibrium except the slowest pool), we interpreted that the slowest pool (hum2) was far from equilibrium yet. The application of the transient correction decreased the slowest pool (carbon above the line of observed carbon stocks in Fig. 5). In the scenario of increased climate sensitivity the relative proportion of the slowest pool after the correction was larger because the spin-up-runs resulted in smaller stocks of all the pools.

The carbon accumulation due to the adjustment of the spin-up-run predicted pools for former disturbances was $5.7 \pm 1.5 \text{ tC/ha}$ with standard climate sensitivity (Fig. 6 top left) and $5.5 \pm 1.8 \text{ tC/ha}$ with increased climate sensitivity (Fig. 7 top left) within 100 years for the baseline scenario. This corresponds to a flux of $5.7 \text{ gC/m}^2/\text{yr}$ and an increase of about 13% of initial carbon stocks over 100 years. This carbon accumulation would have been neglected without the transient correction. Uncertainty resulted from different assumptions of turnover times of the slowest pool of 500 years up to 10 000 years. This uncertainty of 1.5 tC/ha (or 1.8 tC/ha for increased slow pool temperature sensitivity) did not change much with different scenarios of litter input and temperature increase (Figs. 6 and 7). Hence the relative size of the uncertainty depended on the projected change of carbon stocks and varied between 9% in the conservation scenario (Fig. 7 litter) and 59% in the temperature increase scenario (Fig. 7, t3).

Assuming lower decay rates of the slowest pool resulted in an increased carbon accumulation (Fig. 8). Consistently across all scenario groups, the carbon accumulation increased most with the first decrease of the slowest pool's (hum2) decay rate to 20% of standard parameterization. Further decrease of the decay rate to 4%, 0.8%, and 0.16% of standard parameterization only slightly increased carbon accumulation during 100 years.

BGD

3, 1679–1714, 2006

Soils apart equilibrium modelling

T. Wutzler and
M. Reichstein

Title Page

Abstract

Introduction

Conclusions

References

Tables

Figures

⏪

⏩

◀

▶

Back

Close

Full Screen / Esc

Printer-friendly Version

Interactive Discussion

4 Discussion

4.1 What are the consequences for interpretation of current model results?

The equilibrium experiment showed that already very small rates of current accumulation caused tremendous changes in equilibrium stocks (Fig. 4). They are so small, that it is practically impossible to measure them within a few years. The times to reach equilibrium could span millennia. Hence, soils may be far apart from a theoretical equilibrium. They may never reach this theoretical equilibrium because of changing conditions and partial resets by disturbances (e.g. forest fires, Parker et al., 2001; Wardle et al., 2003, or erosion, Polyakov and Lal, 2004) . In addition soil weathering continues and soil horizons may change in a way to increase humus stabilization and potential carbon stocks.

If soils are apart from equilibrium, this leads to a big overestimation of the decay rate of the slowest pool with the current method of constraining the slow pool decay rates. The spin-up-runs will still give reasonable results for soils that have a similar disturbance history as the sites used for parameterization of the model (Peltoniemi et al., 2004). However, with an overestimated decay rate of the slowest pool, the spin-up-runs underestimate the stock at sites that have not been disturbed for a very long time and overestimate the stock at sites that have been disturbed in the former centuries. This still needs to be tested.

Previous model studies of soil carbon stock changes (e.g. Liski et al., 2002) did not take detailed account for the effect of soils recovering from former disturbance (Fig. 6). This results in an underestimation of carbon accumulation in soils.

In a first very rough extrapolation we assume that half of the forested area in Europe is still recovering from former disturbance and that the $5.7 \text{ g/m}^2/\text{yr}$ additional increase that we calculated for the Leinefelde site would occur on this area. With these assumptions, the projected forest soil carbon sink of 7.5 TgC for Europe (EU15 + Norway + Switzerland: 120 million ha) by a recent LPJ modelling study by ATEAM (Lindner et al., 2004; Schröter et al., 2004) would be increased by 3.42 TgC or by 46%. Hence,

BGD

3, 1679–1714, 2006

Soils apart equilibrium modelling

T. Wutzler and
M. Reichstein

Title Page

Abstract

Introduction

Conclusions

References

Tables

Figures

◀

▶

◀

▶

Back

Close

Full Screen / Esc

Printer-friendly Version

Interactive Discussion

the potential carbons sink due to recovering from former disturbance is in the same magnitude as the currently projected sink.

4.2 How can we account for these effects in modelling?

The initialization of the model state needs to account for former disturbances. Soils that have been disturbed centuries ago are still in a transient state due to the long timescales of the slowest pool. At sites, where the relaxed equilibrium assumption is valid (time since last disturbance is longer than a century), the transient correction can be applied.

The transient correction does not specify the decay rate of the slowest pool, because the rate can not be determined by calibrating equilibrium states to current stocks or observing current stock changes. If no method of constraining this rate is available, 1/5 of the standard decay is a good first estimate, because lower rates did not change results much in decadal time scale (Fig. 8).

The variation in uncertainty of carbon stock changes was caused in part by the higher initial percentage of the slow pool in the increased temperature sensitivity scenarios (Fig. 5). We suppose that uncertainty of stock changes due to slow pool parameterization will be largest in soils, where the initial percentage of the slow pool after the transient correction is large or where decay rates are high. All in all, the range of uncertainty in decay rates adds considerable amount of uncertainty in predicted changes of carbon stocks within the next century (Fig. 6 and 7).

Adjustment of pools may initialize models to non-valid states. However, most models have no feedbacks or very weak feedbacks from the slowest pool to the other pools. Hence, we do not expect big numerical errors or anomalies due to the transient correction when simulating the system.

One precondition for applying the transient correction is an independent estimate of current soil carbon stocks. This estimate must account for the disturbance history. Best choice is measuring carbon stocks at the site. However, this is laborious and expensive. If the disturbance history can be assumed to be similar within a region, a spatial

Soils apart equilibrium modelling

T. Wutzler and
M. Reichstein

Title Page

Abstract

Introduction

Conclusions

References

Tables

Figures

⏪

⏩

◀

▶

Back

Close

Full Screen / Esc

Printer-friendly Version

Interactive Discussion

5 extrapolation of measured carbon stocks can be used. Therefore recent literature on spatial extrapolation of carbon measurements is reviewed here. Ryan et al. (2000) present a classification of approaches extrapolating soil properties and some applications. First, there are geostatistical methods, especially kriging (Webster, 1985). Various modifications of kriging can be applied where spatial correlation is high (e.g. Emery, 2006). However, soil carbon stocks at regional scale do not have a good spatial correlation. Second, there are heuristic and knowledge based approaches (Zhou et al., 2005) which infer soil properties based on spatially accessible information. This is closely related to the third group of approaches called environmental correlation which involves the development of statistical models. Spatially available information can be retrieved from forest surveys, carbon stock observations, remote sensing or digital elevation models. While topographic indices (e.g. curvature) are best suited at catchments scale (e.g. Gessler et al., 2000) these indices can be used to define homogenous areas of soil properties in order to scale up point measurements (Baatz and Schäpe, 2000; Burnett and Blaschke, 2003; Friedrich, 1996; Sonnabend, 2002). This allows defining stratum of soils and scale up soil properties by taking into account the area covered by each stratum (e.g. Post et al., 2001). The environmental correlation approach has already been successfully applied using stratum defined by site classifications and forest types (e.g. Liski and Westman, 1997; Perruchoud et al., 2000; Wirth et al., 2004; Wutzler et al., 2006).

4.3 Do the consequences also apply to other models?

The models Century (e.g. Parton et al., 1988), Coup (Jansson and Karlberg, 2004), Romul (Chertov et al., 2001), and the soil model of Biome-BGC (Thornton, 1998) all define a very slow pool. Except Romul, which provides a database of compiled initial states, all these models use the equilibrium assumption to infer initial states. Therefore, the consequences of Yasso model simulations also apply to these models. The transient correction should also be readily applicable to these models except the Roth-C model. The Roth-C model specifies no input to the inert pool and already calibrates

**Soils apart
equilibrium
modelling**

T. Wutzler and
M. Reichstein

Title Page

Abstract

Introduction

Conclusions

References

Tables

Figures

◀

▶

◀

▶

Back

Close

Full Screen / Esc

Printer-friendly Version

Interactive Discussion

the size of the inert pool in a way that the average age of the soil pool matches the age determined by C14 measurements (Martel and Paul, 1974; Rumpel et al., 2002).

4.4 How can we test whether soil carbon stocks are apart from equilibrium?

The influence of former disturbances, namely former land use, on current soil carbon stocks, C:N ratios, nitrification and other soil properties is confirmed by many studies (e.g. Berger et al., 2002; Caspersen et al., 2000; Dupouey et al., 2002; Goodale and Aber, 2001; Janssens et al., 2001; e.g. Koerner et al., 1997; Mund, 2004; Mund and Schulze, 2005; Rothe et al., 2002; Thornton et al., 2002; Wardle et al., 1997). These influences can be much stronger than climatic influences (Caspersen et al., 2000; Janssens et al., 2001) and can be observed after 1700 years (Dupouey et al., 2002). A recent review regarding soil carbon changes in forests concludes that the vast intensive cultivation throughout Europe (deforestation, drainage, deflation and erosion) has caused immense historical losses of soil carbon. Nowadays forested areas with degraded soils are abundant and offer a tremendous potential to restore carbon stocks (Baritz et al., 2004). Foster et al. (2003) describe processes that alter soil properties in historic timescales. The most important ones are probably tillage (Grandy and Robertson, 2006; Wall and Hytonen, 2005) and erosion (Polyakov and Lal, 2004).

One consequence of soil being apart from equilibrium is the underestimation of current soil carbon stocks for sites that have not been disturbed for a much longer time than the sites used for parameterization and the overestimation of current soil carbon stocks for sites that have been disturbed in the last centuries. Is this observed? We did not apply the Yasso model to the old-growth forest with high carbon stocks (Harmon et al., 2004; Wardle et al., 1997), but we realize that the litter input and adjustment of decay rates with climate would not be sufficient to simulate the large stocks. In this study we presented simulations of forest soils that have been disturbed by wood pasture 150 years ago with lower observed carbon stocks than stocks predicted by spin-up runs (Fig. 5). These observations confirm the notion of soils being apart from equilibrium.

Koerner et al. (1999) found that $\delta^{15}\text{N}$ values increase with intensity of former land

Soils apart equilibrium modelling

T. Wutzler and
M. Reichstein

Title Page

Abstract

Introduction

Conclusions

References

Tables

Figures

◀

▶

◀

▶

Back

Close

Full Screen / Esc

Printer-friendly Version

Interactive Discussion

use. They related this to former input of ^{15}N enriched manure, and to the activation of soil nitrification. The increase $\delta^{15}\text{N}$ can be used as a (yet non-quantitative) tracer of previous land use in forests.

4.5 How can we interpret and constrain the slow pool's decay rate without assuming equilibrium?

There are only vague ideas about which processes determine the slow kinetically defined pools and their decay rate. Cousteaux et al. (1995) present a conceptual model of decomposition in the organic layer that is divided in three phases. The initial phase could be roughly attributed to the decay of the extractives, celluloses, and lignin pools of the Yasso model, the late phase to the pools lignin and humus one pool, and the final stage to the decay of the most recalcitrant pool. Howard et al. (1974) found, when extrapolating mass loss of litter bag studies with an asymptotic model, that in many cases the proportion of mass that is decayed, is smaller than 100% and that there is a part of the litter that is transformed to stable components. Björn Berg termed the asymptote of the decay "limit value" and showed that it can be correlated with litter quality and climatic conditions (e.g. Berg et al., 2003; Berg et al., 1996). If pools are attributed to the decay phases as described above, the portion above the limit value corresponds to the flux into the slowest pool. It needs to be investigated, if this approach can be used to constrain the slower pools without the equilibrium assumption. The parameterization of the slow pools then will depend on litter quality, namely initial nitrogen content, and climatic drivers.

Another expensive approach is to measure ^{14}C ages of soils. This average age of soil carbon could be used to constrain the proportions of the two slowest pools, and hence its decay rate. In order to avoid expensive ^{14}C measurements, empirical relationships can be used (Falloon et al., 1998).

Soils apart equilibrium modelling

T. Wutzler and
M. Reichstein

Title Page

Abstract

Introduction

Conclusions

References

Tables

Figures

⏪

⏩

◀

▶

Back

Close

Full Screen / Esc

Printer-friendly Version

Interactive Discussion

5 Conclusions

- Observations of current soil carbon stocks are not sufficient to constrain the decay rates of the recalcitrant components and the corresponding equilibrium carbon stocks, because it is not known whether carbon stocks are in equilibrium, because of the long time scales of recovering from disturbances.
- If soils are apart from equilibrium, spin-up runs are only valid for sites that have a similar disturbance history as the sites used for model calibration. The spin-up runs underestimate the stock of sites that have not been disturbed for a very long time and overestimate the stock of sites that have been disturbed two or three centuries ago.
- Spin-up runs of the kinetic pool defined models should be corrected by the “transient correction”, i.e. the adjustment of the slowest pool in a way that the sum of soil pools matches an independent estimate of soil carbon stocks. Such an estimate can be obtained by soil carbon stock observations or by regional statistical models that can account for the unknown but similar disturbance history.
- In century-term simulations the uncertainty due to the unknown decay rate of the slowest pool results in uncertainty of stock changes in the magnitude of $1 \text{ g/m}^2/\text{yr}$. This uncertainty is reasonably small compared to simulated changes in soil carbon stocks due to litter input and climate change in most cases. The amount of uncertainty does not change very much with changing litter input and changing temperature. However, this amount increases with temperature sensitivity of the slow pools and the initial proportion of the stock of the slowest carbon pool.
- Carbon storage capacity of forest soils is potentially much higher than currently assumed.
- Century-term simulation of changes in soil carbon stocks that use spin-up-runs without the transient correction miss a substantial amount of carbon accumulation

BGD

3, 1679–1714, 2006

Soils apart equilibrium modelling

T. Wutzler and
M. Reichstein

Title Page

Abstract

Introduction

Conclusions

References

Tables

Figures

◀

▶

◀

▶

Back

Close

Full Screen / Esc

Printer-friendly Version

Interactive Discussion

at many forest sites.

Appendix A

Calculation of average litter inputs

5 In addition to the measured litter input, we calculated input by harvest residues and coarse roots after harvest in the following way. Merchantable timber volume and volume increment of the remaining part of the stand was estimated by yield tables (Dittmar et al., 1986). We assumed a harvest of 50% of the volume at age 140 years and 15%, 15% and 20% at the ages 150, 160, 170 years respectively. Carbon mass of tree compartments stem, branches were estimated by age and site index dependent conversion factors of (Wirth et al., 2004). Extracted wood volume on harvest was 92% of merchantable timber volume (Weber personal communication). Carbon mass of harvest residues was calculated by the difference between stem/branch carbon and the carbon mass of the extracted wood by applying a wood density of 0.56 t/m^3 and a carbon concentration of 48.6%. (Weiss et al., 2000). The harvest residues and roots were partitioned to the inputs of the Yasso model according to Table 4. The coarse woody part of harvest residues was removed by about 90% by wood pickers (Mund, personal communication). The sum of harvest residues and root biomass was divided by the rotation length of 140 years and added to the average litter inputs.

Appendix B

Parameterization of the Yasso model

Following tables list the standard parameters that have been applied to the Yasso Model for simulation experiments.

BGD

3, 1679–1714, 2006

Soils apart equilibrium modelling

T. Wutzler and
M. Reichstein

Title Page

Abstract

Introduction

Conclusions

References

Tables

Figures

◀

▶

◀

▶

Back

Close

Full Screen / Esc

Printer-friendly Version

Interactive Discussion

climatic parameters (standard climate)

mat0	3.3°C	standard mean annual temperature
drought0	-32 mm	standard precipitation – potential evapotranspiration from may to september
beta	0.105	effect of mean annual temperature
gamma	0.00274	effect of drought

- 5 decomposition rates (k) and mass proportions of decay use to form more recalcitrant components (p)

Compartment	k [1/yr]	p [1]	
ext	0.48	0.2	conifers
ext_b	0.82	0.2	deciduous
cel	0.30	0.2	
lig	0.22	0.2	
hum1	0.012	0.2	
hum2	0.0012	0	

- 10 standard relative sensitivity of slow pool decay rates to differences in temperature and drought

s1 (hum1)	0.6
s2 (hum2)	0.36

- 15 microbial invasion rates with standard climate

compartment	a [1/yr]
fwl	0.54
cwl_small	0.077
cwl_large	0.030

BGD

3, 1679–1714, 2006

Soils apart equilibrium modelling

T. Wutzler and
M. Reichstein

Title Page

Abstract

Introduction

Conclusions

References

Tables

Figures

◀

▶

◀

▶

Back

Close

Full Screen / Esc

Printer-friendly Version

Interactive Discussion

chemical composition of litter, used in the equilibrium experiment (pinus sylvestris).

compartment	ext	ext_b	cel	lig
nwl	0.27	0	0.51	0.22
fwl	0.03	0	0.66	0.31
cwl	0.01	0	0.69	0.3

chemical composition of litter, used in the Leinefelde application (broadleaved)

compartment	ext	ext_b	cel	lig
nwl	0	0.38	0.36	0.26
fwl	0	0.03	0.65	0.32
cwl	0	0.01	0.77	0.22

Acknowledgements. The authors thank their participants of the international workshop on “Development of Models and Forest Soil Surveys for Monitoring of Soil Carbon” for fruitful discussions.

References

- Ågren, G. I.: Temperature dependence of old soil organic matter, *Ambio*, 29, 55–55, 2000.
- Baatz, M. and Schäpe, A.: Multiresolution Segmentation – an optimization approach for high quality multi-scale image segmentation, in: *Angewandte Geographische Informationsverarbeitung*, edited by: Strobl, J., Blaschke, T., and Griesebner, G., Wichmann-Verlag, Heidelberg, 2000.
- Baritz, R., De Neve, S., Brancikova, G., Gronlund, A., Leifeld, J., Katzensteiner, K., Koch, H. J., Palliere, C., Romanya, J., and Schaminee, J.: Task Group 5 – Land Use Practices and Soil Organic Matter, in: . Reports of the Technical Working Groups established under the

BGD

3, 1679–1714, 2006

Soils apart equilibrium modelling

T. Wutzler and
M. Reichstein

Title Page

Abstract

Introduction

Conclusions

References

Tables

Figures

◀

▶

◀

▶

Back

Close

Full Screen / Esc

Printer-friendly Version

Interactive Discussion

- Thematic Strategy for Soil Protection, Van-Camp, L., Bujarrabal, B., Gentile, A. R., Jones, R. J. A., Montanarella, L., Olazabal, C., and Selvaradjou, S.-K., Volume 2 Soil Organic Matter Decline., Office for Official Publications of the European Communities, Luxembourg, 2004.
- 5 Berg, B., De Santo, A. V., Rutigliano, F. A., Fierro, A., and Ekbohm, G.: Limit values for plant litter decomposing in two contrasting soils – influence of litter elemental composition, *Acta Oecologica-International Journal of Ecology*, 24, 295–302, 2003.
- Berg, B., Ekbohm, G., Johansson, M. B., McClaugherty, C., Rutigliano, F., and DeSanto, A. V.: Maximum decomposition limits of forest litter types: A synthesis, *Canadian Journal of Botany-Revue Canadienne De Botanique*, 74, 659–672, 1996.
- 10 Berger, T. W., Neubauer, C., and Glatzel, G.: Factors controlling soil carbon and nitrogen stores in pure stands of Norway spruce (*Picea abies*) and mixed species stands in Austria, *Forest Ecol. Manage.*, 159, 3–14, 2002.
- Burnett, C. and Blaschke, T.: A multi-scale segmentation/object relationship modelling methodology for landscape analysis, *Ecol. Model.*, 168, 233–249, 2003.
- 15 Caspersen, J. P., Pacala, S. W., Jenkins, J. C., Hurtt, G. C., Moorcroft, P. R., and Birdsey, R. A.: Contributions of land-use history to carbon accumulation in U.S. forests, *Science*, 290, 1148–1151, 2000.
- Chertov, O. G., Komarov, A. S., Nadporozhskaya, M., Bykhovets, S. S., and Zudin, S. L.: ROMUL – a model of forest soil organic matter dynamics as a substantial tool for forest ecosystem modeling, *Ecological Modelling*, 138, 289–308, 2001.
- 20 Couteaux, M. M., Bottner, P., and Berg, B.: Litter decomposition, climate and litter quality, *Trends in Ecology & Evolution*, 10, 63–66, 1995.
- Davidson, E. A. and Janssens, I. A.: Temperature sensitivity of soil carbon decomposition and feedbacks to climate change, *Nature*, 440, 165–173, 2006.
- 25 Dittmar, O., Knapp, E., and Lembecke, G.: DDR Buchenertragstafel 1983, IFE-Berichte aus Forschung und Entwicklung, 4, 1–59, 1986.
- Drexhage, M. and Gruber, F.: Architecture of the skeletal root system of 40-year-old *Picea abies* on strongly acidified soils in the Harz Mountains (Germany), *Canadian Journal of Forest Research-Revue Canadienne De Recherche Forestiere*, 28, 13–22, 1998.
- 30 Dupouey, J. L., Dambrine, E., Laffite, J. D., and Moares, C.: Irreversible impact of past land use on forest soils and biodiversity, *Ecology*, 83, 2978–2984, 2002.
- Emery, X.: Ordinary multigaussian kriging for mapping conditional probabilities of soil properties, *Geoderma*, 132, 75–88, 2006.

BGD

3, 1679–1714, 2006

**Soils apart
equilibrium
modelling**

T. Wutzler and
M. Reichstein

Title Page

Abstract

Introduction

Conclusions

References

Tables

Figures

◀

▶

◀

▶

Back

Close

Full Screen / Esc

Printer-friendly Version

Interactive Discussion

- Falloon, P., Smith, P., Coleman, K., and Marshall, S.: Estimating the size of the inert organic matter pool from total soil organic carbon content for use in the Rothamsted carbon model, *Soil Biol. Biochem.*, 30, 1207–1211, 1998.
- Foster, D., Swanson, F., Aber, J., Burke, I., Brokaw, N., Tilman, D., and Knapp, A.: The importance of land-use legacies to ecology and conservation, *Bioscience*, 53, 77–88, 2003.
- Friedrich, K.: *Digitale Reliefgliederungsverfahren zur Ableitung bodenkundlich relevanter Flächeneinheiten*, Institut für Physische Geographie der Johann Wolfgang Goethe-Universität, Frankfurt a.M., 1996.
- Gessler, P. E., Chadwick, O. A., Chamran, F., Althouse, L., and Holmes, K.: Modeling soil-landscape and ecosystem properties using terrain attributes, *Soil Sci. Soc. Am. J.*, 64, 2046–2056, 2000.
- Goodale, C. L. and Aber, J. D.: The long-term effects of land-use history on nitrogen cycling in northern hardwood forests, *Ecol. Appl.*, 11, 253–267, 2001.
- Grandy, A. S. and Robertson, G. P.: Aggregation and organic matter protection following tillage of a previously uncultivated soil, *Soil Sci. Soc. Am. J.*, 70, 1398–1406, 2006.
- Harmon, M. E., Bible, K., Ryan, M. G., Shaw, D. C., Chen, H., Klopatek, J., and Li, X.: Production, respiration, and overall carbon balance in an old-growth *Pseudotsuga-tsuga* forest ecosystem, *Ecosystems*, 7, 498–512, 2004.
- Howard, P. J. A. and Howard, D. M.: Microbial decomposition of tree and shrub leaf litter. 1. Weight loss and chemical composition of decomposing litter., *Oikos*, 25, 311–352, 1974.
- Janssens, I. A., Lankreijer, H., Matteucci, G., Kowalski, A. S., Buchmann, N., Epron, D., Pilegaard, K., Kutsch, W., Longdoz, B., Grunwald, T., Montagnani, L., Dore, S., Rebmann, C., Moors, E. J., Grelle, A., Rannik, U., Morgenstern, K., Oltchev, S., Clement, R., Gudmundsson, J., Minerbi, S., Berbigier, P., Ibrom, A., Moncrieff, J., Aubinet, M., Bernhofer, C., Jensen, N. O., Vesala, T., Granier, A., Schulze, E.-D., Lindroth, A., Dolman, A. J., Jarvis, P. G., Ceulemans, R., and Valentini, R.: Productivity overshadows temperature in determining soil and ecosystem respiration across European forests, *Global Change Biol*, 7, 269–278, 2001.
- Jansson, P.-E. and Karlberg, L.: Coupled heat and mass transfer model for soil-plant-atmosphere systems, Royal Institute of Technology, Dept of Civil and Environmental Engineering, Stockholm, 2004.
- Jenkinson, D. S.: The Turnover of Organic-Carbon and Nitrogen in Soil, *Philosophical Transactions of the Royal Society of London Series B-Biol. Sci.*, 329, 361–368, 1990.
- Kaipainen, T., Liski, J., Pussinen, A., and Karjalainen, T.: Managing carbon sinks by changing

**Soils apart
equilibrium
modelling**T. Wutzler and
M. Reichstein

Title Page

Abstract

Introduction

Conclusions

References

Tables

Figures

◀

▶

◀

▶

Back

Close

Full Screen / Esc

Printer-friendly Version

Interactive Discussion

- rotation length in European forests, *Environ. Sci. Policy*, 7, 205–219, 2004.
- Koerner, W., Dambrine, E., Dupouey, J. L., and Benoit, M.: delta N-15 of forest soil and understorey vegetation reflect the former agricultural land use, *Oecologia*, 121, 421–425, 1999.
- Koerner, W., Dupouey, J. L., Dambrine, E., and Benoit, M.: Influence of past land use on the vegetation and soils of present day forest in the Vosges mountains, France, *J. Ecol.*, 85, 351–358, 1997.
- Kummetz, E.: Die Wurzelentwicklung der Fichte (*Picea abies* [L.] Karst.). Universität Bayreuth, Bayreuth, 1996.
- Le Goff, N. and Ottorini, J. M.: Root biomass and biomass increment in a beech (*Fagus sylvatica* L.) stand in North-East France, *Annals Forest Sci.*, 58, 1–13, 2001.
- Lindner, M., Lucht, W., Bouriaud, O., Green, T., and Janssens, I. A.: Specific Study on Forest Greenhouse Gas Budget, Concerted Action CarboEurope-GHG, 2004.
- Liski, J., Palosuo, T., Peltoniemi, M., and Sievanen, R.: Carbon and decomposition model Yasso for forest soils, *Ecological Modelling*, 189, 168–182, 2005.
- Liski, J., Perruchoud, D., and Karjalainen, T.: Increasing carbon stocks in the forest soils of western Europe, *Forest Ecol. Manage.*, 169, 159–175, 2002.
- Liski, J. and Westman, C. J.: Carbon storage in forest soil of Finland. 2. Size and regional patterns, *Biogeochemistry*, 36, 261–274, 1997.
- Martel, Y. A. and Paul, E. A.: Use of Radiocarbon Dating of Organic-Matter in Study of Soil Genesis, *Soil Sci. Soc. Am. J.*, 38, 501–506, 1974.
- Mund, M.: Carbon pools European beech forests (*Fagus sylvatica*) under different silvicultural management, University Göttingen, Göttingen, 2004.
- Mund, M. and Schulze, E.-D.: Silviculture and Its Interactions with Biodiversity and the Carbon Balance of Forest Soils, in: *Forest Diversity and Function: Temperate and Boreal Systems*, edited by: Scherer-Lorenzen, M., Körner, C., and Schulze, E.-D., Springer, Berlin Heidelberg, 2005.
- Nabuurs, G. J. and Schelhaas, M. J.: Carbon profiles of forests across Europe, an application of co2fix., *Ecological Indicators*, 1, 213–223, 2002.
- Palosuo, T., Liski, J., Trofymow, J. A., and Titus, B. D.: Litter decomposition affected by climate and litter quality - Testing the Yasso model with litterbag data from the Canadian intersite decomposition experiment, *Ecol. Modell.*, 189, 183–198, 2005.
- Parker, J. L., Fernandez, I. J., Rustad, L. E., and Norton, S. A.: Effects of nitrogen enrichment, wildfire, and harvesting on forest-soil carbon and nitrogen, *Soil Sci. Soc. Am. J.*, 65, 1248–

**Soils apart
equilibrium
modelling**T. Wutzler and
M. Reichstein

Title Page

Abstract

Introduction

Conclusions

References

Tables

Figures

◀

▶

◀

▶

Back

Close

Full Screen / Esc

Printer-friendly Version

Interactive Discussion

1255, 2001.

Parton, W. J., Stewart, J. W. B., and Cole, C. V.: Dynamics of C, N, P and S in Grassland Soils – a Model, *Biogeochemistry*, 5, 109–131, 1988.

Peltoniemi, M., Makipaa, R., Liski, J., and Tamminen, P.: Changes in soil carbon with stand age – an evaluation of a modelling method with empirical data, *Global Change Biol.*, 10, 2078–2091, 2004.

Perruchoud, D., Walthert, L., Zimmermann, S., and Luscher, P.: Contemporary carbon stocks of mineral forest soils in the Swiss Alps, *Biogeochemistry*, 50, 111–136, 2000.

Polyakov, V. and Lal, R.: Modeling soil organic matter dynamics as affected by soil water erosion, *Environ. Int.*, 30, 547–556, 2004.

Post, W. M., Izaurrealde, R. C., Mann, L. K., and Bliss, N.: Monitoring and verifying changes of organic carbon in soil, *Climatic Change*, 51, 73–99, 2001.

Rothe, A., Kreuzer, K., and Kuchenhoff, H.: Influence of tree species composition on soil and soil solution properties in two mixed spruce-beech stands with contrasting history in Southern Germany, *Plant and Soil*, 240, 47–56, 2002.

Rumpel, C., Kogel-Knabner, I., and Bruhn, F.: Vertical distribution, age, and chemical composition of organic carbon in two forest soils of different pedogenesis, *Organic Geochem.*, 33, 1131–1142, 2002.

Ryan, P. J., McKenzie, N. J., O’Connell, D., Loughhead, A. N., Leppert, P. M., Jacquier, D., and Ashton: Integrating forest soils information across scales: spatial prediction of soil properties under Australian forests, *Forest Ecol. Manage.*, 138, 139–157, 2000.

Schröter, D., Acosta-Michlik, L., Arnell, A. W., Araújo, M. B., Badeck, F., Bakker, M., Bondeau, A., Bugmann, H., Carter, T., de la Vega-Leinert, A. C., Erhard, M., Espiñeira, G. Z., Ewert, F., Fritsch, U., Friedlingstein, P., Glendining, M., Gracia, C. A., Hickler, T., House, J., Hulme, M., Kankaanpää, S., Klein, R. J. T., Krukenberg, B., Lavorel, S., Leemans, R., Lindner, M., Liski, J., Metzger, M. J., Meyer, J., Mitchell, T., Mohren, F., Morales, P., Moreno, J. M., Reginster, I., Reidsma, P., Rounsevell, M., Pla, E., Pluimers, J., Prentice, I. C., Pussinen, A., Sánchez, A., Sabaté, S., Sitch, S., Smith, B., Smith, J., Smith, P., Sykes, M. T., Thonicke, K., Thuiller, W., Tuck, G., van der Werf, G., Vayreda, J., Wattenbach, M., Wilson, D. W., Woodward, F. I., Zaehle, S., Zierl, B., Zudin, S., and Cramer, W.: ATEAM Final report 2004. Potsdam Institute for Climate Impact Research, Potsdam, Germany, 2004.

Smith, J., Smith, P., Wattenbach, M., Zaehle, S., Hiederer, R., Jones, R. J. A., Montanarella, L., Rounsevell, M. D. A., Reginster, I., and Ewert, F.: Projected changes in mineral soil carbon

BGD

3, 1679–1714, 2006

Soils apart equilibrium modelling

T. Wutzler and
M. Reichstein

Title Page

Abstract

Introduction

Conclusions

References

Tables

Figures

◀

▶

◀

▶

Back

Close

Full Screen / Esc

Printer-friendly Version

Interactive Discussion

- of European croplands and grasslands, 1990–2080, *Global Change Biol.*, 11, 2141–2152, 2005.
- Smith, P., Smith, J. U., Powlson, D. S., McGill, W. B., Arah, J. R. M., Chertov, O. G., Coleman, K., Franko, U., Frolking, S., Jenkinson, D. S., Jensen, L. S., Kelly, R. H., Klein-Gunnewiek, H., Komarov, A. S., Li, C., Molina, J. A. E., Mueller, T., Parton, W. J., Thornley, J. H. M., and Whitmore, A. P.: A comparison of the performance of nine soil organic matter models using datasets from seven long-term experiments, *Geoderma*, 81, 153–225, 1997.
- Sonnabend, B.: Verfahren der digitalen Reliefanalyse zur Ableitung bodenkundlich relevanter Konturen auf verschiedenen Skalenebenen. Martin-Luther-Universität Halle-Wittenberg Fachbereich Geowissenschaften Institut für Geographie, Halle, 2002.
- Thornton, P.: Description of a numerical simulation model for predicting the dynamics of energy, water, carbon, and nitrogen in a terrestrial ecosystem, 1998.
- Thornton, P. E., Law, B. E., Gholz, H. L., Clark, K. L., Falge, E., Ellsworth, D. S., Golstein, A. H., Monson, R. K., Hollinger, D., Falk, M., Chen, J., and Sparks, J. P.: Modeling and measuring the effects of disturbance history and climate on carbon and water budgets in evergreen needleleaf forests, *Agric. Forest Meteorol.*, 113, 185–222, 2002.
- Wall, A. and Hytonen, J.: Soil fertility of afforested arable land compared to continuously, *Plant and Soil*, 275, 247–260, 2005.
- Wardle, D. A., Hornberg, G., Zackrisson, O., Kalela-Brundin, M., and Coomes, D. A.: Long-term effects of wildfire on ecosystem properties across an island area gradient, *Science*, 300, 972–975, 2003.
- Wardle, D. A., Zackrisson, O., Hornberg, G., and Gallet, C.: The influence of island area on ecosystem properties, *Science*, 277, 1296–1299, 1997.
- Webster, R.: Quantitative spatial analysis of soil in the field, *Adv. Soil Sci.*, 3, 1–70, 1985.
- Weiss, P., Schieler, K., Schadauer, K., Radunsky, K., and Englisch, M.: Die Kohlenstoffbilanz des österreichischen Waldes und Betrachtungen zum Kyoto-Protokoll (The carbon balance of the Austrian forest and considerations in view of the Kyoto-protocol), Umweltbundesamt, Vienna, Austria, 2000.
- Wirth, C., Schulze, E.-D., Schwalbe, G., Tomczyk, S., Weber, G., and Weller, E.: Dynamik der Kohlenstoffvorräte in den Wäldern Thüringens- Abschlussbericht zur 1. Phase des BMBF-Projektes “Modelluntersuchung zu Umsetzung des Kyoto-Protokolls”. Thüringer Landesanstalt für Jagd, Wald und Fischerei, Jena Gotha, 2004.
- Wutzler, T., Köstner, B., and Bernhofer, C.: Spatially Explicit Assessment of Carbon Stocks of

BGD

3, 1679–1714, 2006

Soils apart equilibrium modelling

T. Wutzler and
M. Reichstein

Title Page

Abstract

Introduction

Conclusions

References

Tables

Figures

◀

▶

◀

▶

Back

Close

Full Screen / Esc

Printer-friendly Version

Interactive Discussion

a Managed Forest Area in Eastern Germany, J. Europ. Forest Res., Accepted, 2006.
Zhou, B., Zhang, X. G., Wang, F., and Wang, R. C.: Soil organic matter mapping by decision tree modeling, Pedosphere, 15, 103–109, 2005.

BGD

3, 1679–1714, 2006

**Soils apart
equilibrium
modelling**

T. Wutzler and
M. Reichstein

Title Page

Abstract

Introduction

Conclusions

References

Tables

Figures

◀

▶

◀

▶

Back

Close

Full Screen / Esc

Printer-friendly Version

Interactive Discussion

EGU

Soils apart
equilibrium
modelling

T. Wutzler and
M. Reichstein

Table 1. Comparison of equations between the usual equilibrium assumption and the relaxed equilibrium assumption for the slowest pool. k : decay rate, i : input rate, C_c : current stock, C_e : equilibrium stock.

	Usual	Relaxed
Mass balance	$i = k \cdot C_c; \quad \frac{\delta C_c}{\delta t} = 0$	$i = k \cdot C_c + \frac{\delta C_c}{\delta t}$
Decay rate	$k = \frac{i}{C_c}$	$k = \frac{i - \frac{\delta C_c}{\delta t}}{C_c}$
Equilibrium stock	$C_e = \frac{i}{k} = C_c$	$C_e = \frac{i}{k} > C_c$

Title Page

Abstract

Introduction

Conclusions

References

Tables

Figures

⏪

⏩

◀

▶

Back

Close

Full Screen / Esc

Printer-friendly Version

Interactive Discussion

**Soils apart
equilibrium
modelling**

T. Wutzler and
M. Reichstein

Title Page

Abstract

Introduction

Conclusions

References

Tables

Figures

⏪

⏩

◀

▶

Back

Close

Full Screen / Esc

Printer-friendly Version

Interactive Discussion

Table 2. Scenario groups of the simulations of the Leinefelde/Mühlhausen chronosequence. Within each group simulations were performed with different decay rates of the slowest pool (hum2) and repeated with increase climate sensitivity.

Scenario Group	Description
base	current inputs and current temperature
litter	increase of litter inputs by assuming that all the wood remains in the forest (conservation scenario)
t3-t9	increase of temperature by 3,6, and 9 Kelvin gradually over the next 100 years
t3+litter	increase of litter input and increase of temperature by 3 Kelvin

**Soils apart
equilibrium
modelling**

T. Wutzler and
M. Reichstein

Table 3. Average litter inputs to the Yasso model [tC/ha/yr]. nwl: non woody litter, fwl: fine woody litter, cwl_small: coarse woody litter with a diameter diameter 6–20 cm, cwl_large: coarse woody litter with a diameter 20–60 cm.

Scenario Group	nwl	fwl	cwl_small	cwl_large
base, t3-t9	3.148693	0.528087	0.208115	0.08467
litter, t3+litter	3.148693	0.865541	1.242068	0.213914

Title Page

Abstract

Introduction

Conclusions

References

Tables

Figures

⏪

⏩

◀

▶

Back

Close

Full Screen / Esc

Printer-friendly Version

Interactive Discussion

**Soils apart
equilibrium
modelling**

T. Wutzler and
M. Reichstein

Table 4. Partitioning of the harvest residues and the root after harvest (excluding fine roots) to different inputs of the Yasso model. fwl: fine woody litter, cwl_small, coarse woody litter with a diameter diameter 6–20 cm, coarse woody litter with a diameter 20–60 cm. Proportion of fwl/cwl of roots is based on (Kummetz, 1996), proportion of cwl_small/cwl_large of roots is a reasonable guess according proportion coarse roots/stump. Other studies of root biomass do not distinguish different coarse roots with a diameter greater 2 mm (e.g. Drexhage and Gruber, 1998; e.g. Le Goff and Ottorini, 2001).

	Harvest Residues	Root
fwl	25%	21%
cwl_small	67%	55%
cwl_large	8%	24%

Title Page

Abstract

Introduction

Conclusions

References

Tables

Figures

⏪

⏩

◀

▶

Back

Close

Full Screen / Esc

Printer-friendly Version

Interactive Discussion

Soils apart
equilibrium
modelling

T. Wutzler and
M. Reichstein

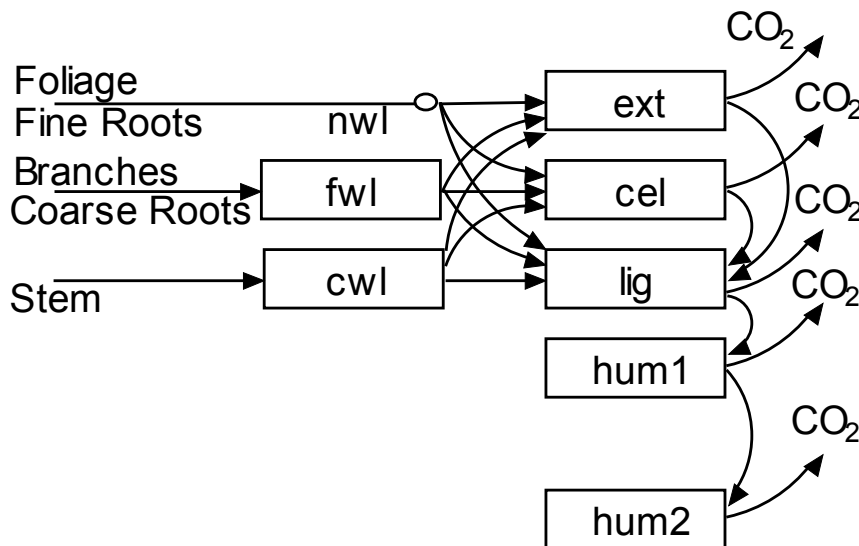

Fig. 1. Model Structure of the Yasso Model (Liski et al., 2005). The pools on the left side describe woody litter that becomes available for decomposition after a delay (nwl: non-woody litter, fwl: fine woody litter, cwl: coarse woody litter). The pools on the right side (ext: extractives, cel: celluloses, lig: lignin, hum1: humus1, hum2: humus2) represent soil carbon pools of different stability that are modeled by different decay rates of an exponential decay. The ext pool has the largest decay rate (i.e. least stability and shortest turnover time) and the hum2 pool has the smallest decay rate (i.e. highest stability and longest turnover time).

Title Page

Abstract

Introduction

Conclusions

References

Tables

Figures

◀

▶

◀

▶

Back

Close

Full Screen / Esc

Printer-friendly Version

Interactive Discussion

Soils apart
equilibrium
modelling

T. Wutzler and
M. Reichstein

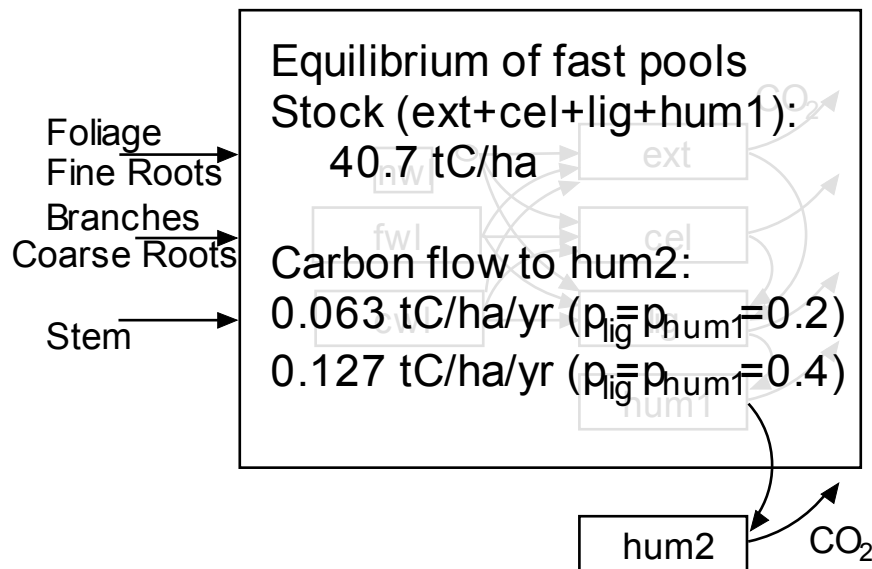

Fig. 2. Relaxed equilibrium assumption: all pools are assumed to be in equilibrium except the slowest pool (hum2). Constant average litter input determines equilibrium stocks of the faster pools and the constant flow to the slowest pool.

Title Page

Abstract

Introduction

Conclusions

References

Tables

Figures

◀

▶

◀

▶

Back

Close

Full Screen / Esc

Printer-friendly Version

Interactive Discussion

Soils apart equilibrium modelling

T. Wutzler and M. Reichstein

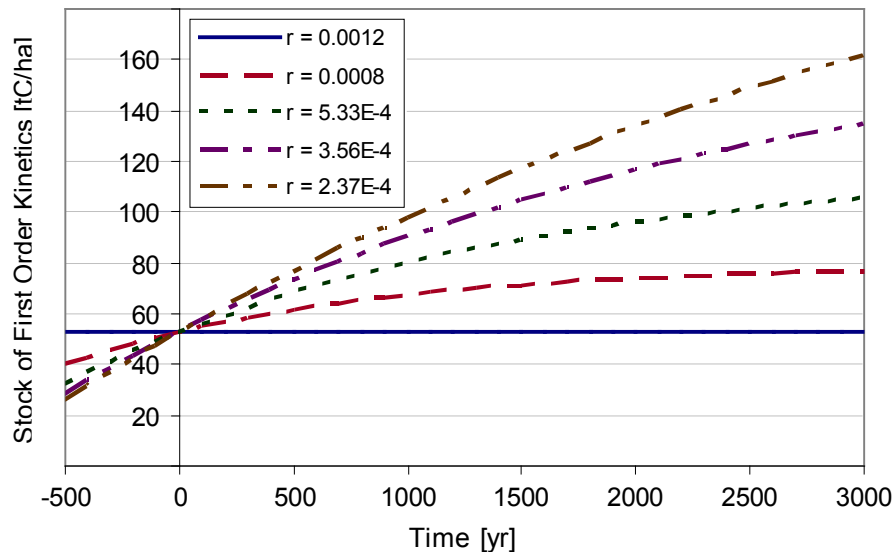

Fig. 3. Trajectories of the slowest pool of the Yasso model with different decay rates. Dynamics is described by a first order kinetics with constant input (Eq. 3): $C = \frac{i}{k} - \left(\frac{i}{k} - C_0\right) \cdot e^{-k \cdot t}$; input $i=0.06345$ tC/ha/yr; stock at time zero $C_0=52.874$ tC/ha. The lower the decay rate, the higher is the resulting theoretical equilibrium stock and the larger is the current rate of carbon accumulation, which is given by the slope $\Delta C/\Delta t$ at time zero.

Title Page

Abstract

Introduction

Conclusions

References

Tables

Figures

◀

▶

◀

▶

Back

Close

Full Screen / Esc

Printer-friendly Version

Interactive Discussion

Soils apart
equilibrium
modelling

T. Wutzler and
M. Reichstein

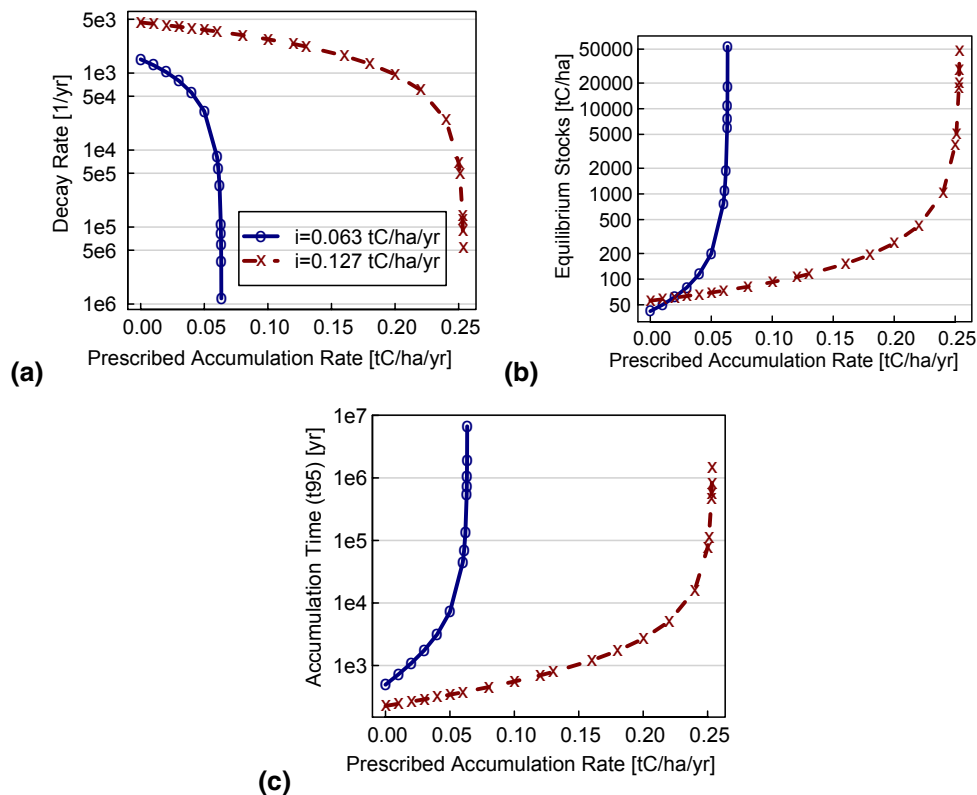

Fig. 4. Decay rates (a) (Eq. 4), equilibrium stocks (b) (Eq. 5), and accumulation times (c) (Eq. 6) that result when different rates of current carbon accumulation (x-axis) are prescribed. Symbols correspond to two different equilibrium inputs that result from a variation in the proportion of decomposed mass in the Yasso Model.

Title Page	
Abstract	Introduction
Conclusions	References
Tables	Figures
◀	▶
◀	▶
Back	Close
Full Screen / Esc	
Printer-friendly Version	
Interactive Discussion	

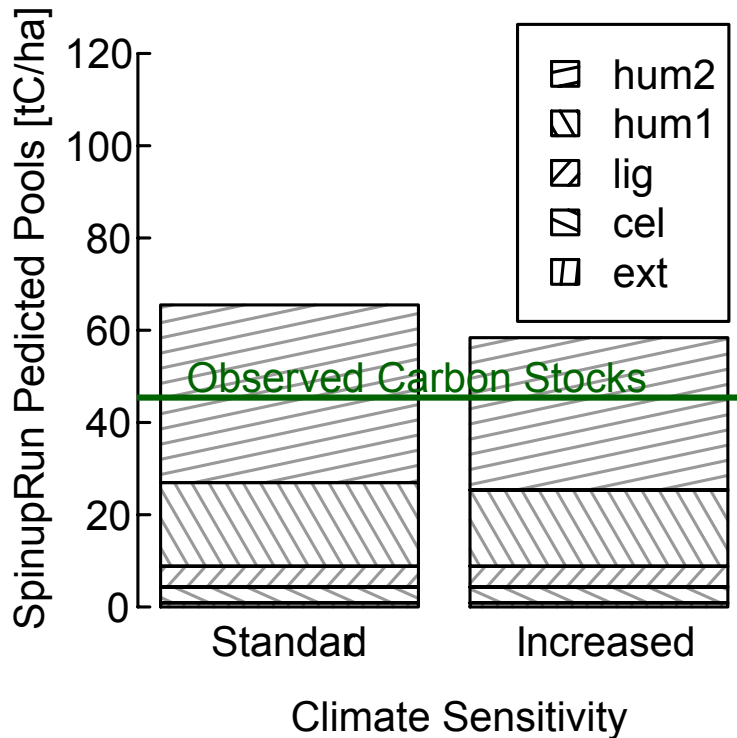

Fig. 5. Transient correction at the Mühlhausen/Leinefelde site. Spin-up-runs of the Yasso model simulate the theoretical equilibrium stocks of the kinetically defined soil carbon pools (ext, cel, lig, hum1, and hum2). The transient correction decreased the slowest pool (hum2) so that the sum of the pools matches the observed carbon stocks. Climatic sensitivity: The decay rates of the slower pools were less sensitive to warming than the faster pools with standard parameterization and equally sensitive ($s_1=s_2=100\%$) in the scenarios of increased climate sensitivity.

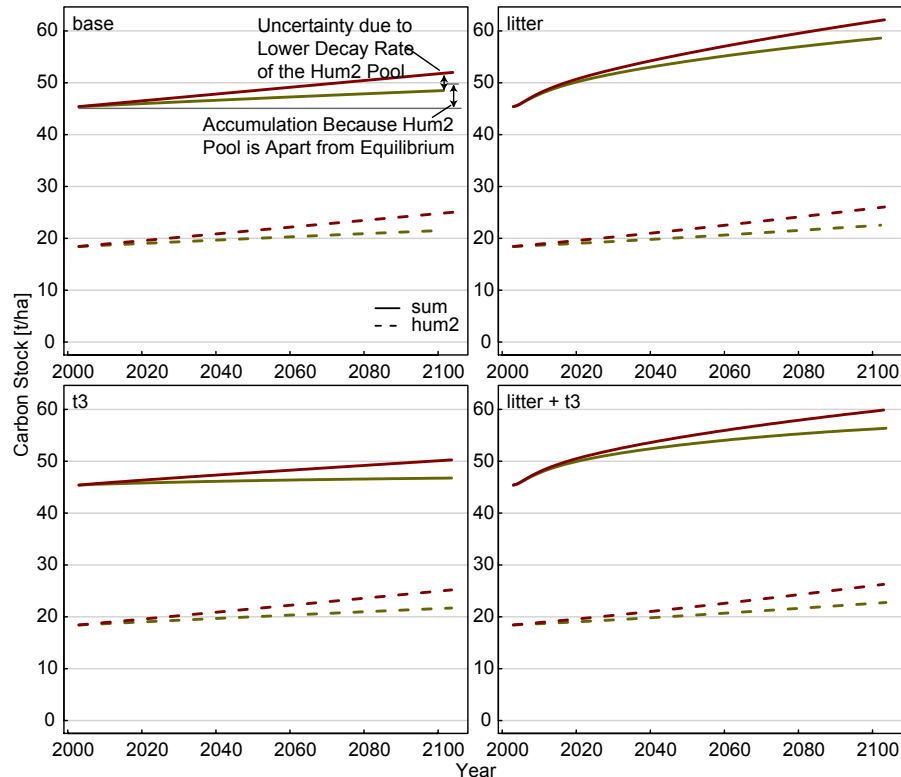

Fig. 6. Development of the soil carbon stocks at the Leinefelde chronosequence simulated by the Yasso model with standard climate sensitivity. The sum-lines represent the sum of the stocks of the Yasso soil pools (ext+cel+lig+hum1+hum2). The four panels correspond to different scenario groups (base: no change in litter inputs and temperature, litter: increase litter input, t3: temperature increase of 3 K gradually over 100 years). The diverging lines represent the boundaries of the stocks with different parameterizations of the decay rate of the slowest pool (hum2).

**Soils apart
equilibrium
modelling**

T. Wutzler and
M. Reichstein

Title Page

Abstract

Introduction

Conclusions

References

Tables

Figures

◀

▶

◀

▶

Back

Close

Full Screen / Esc

Printer-friendly Version

Interactive Discussion

Soils apart
equilibrium
modelling

T. Wutzler and
M. Reichstein

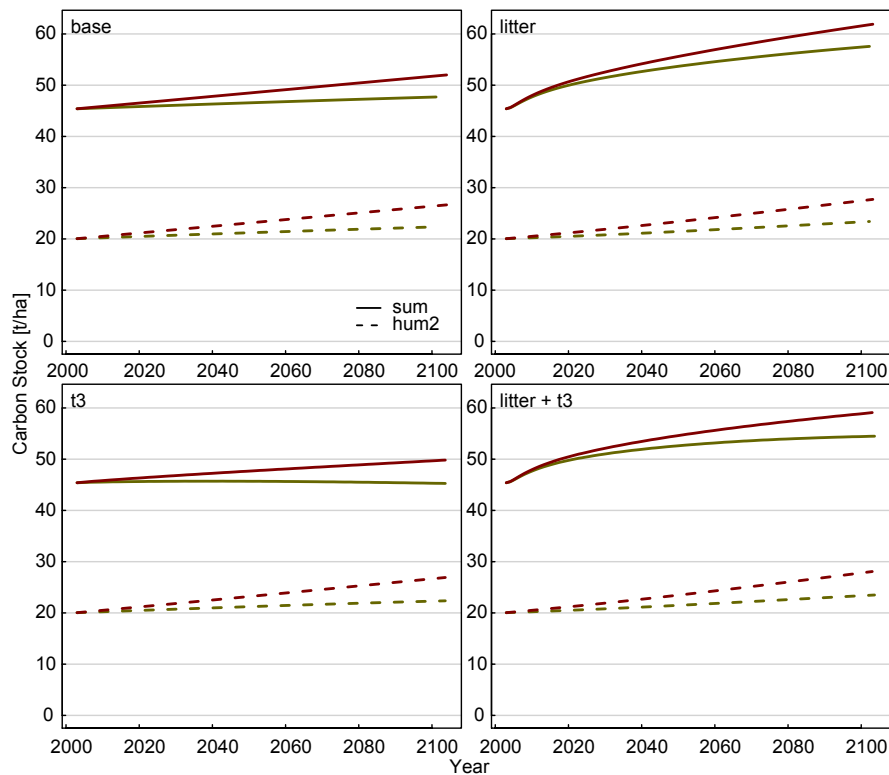

Fig. 7. Development of the soil carbon stocks at the Leinefelde chronosequence simulated like the ones in figure 6 except an increased climate sensitivity of the slow pools ($s_1=s_2=100\%$).

Title Page

Abstract

Introduction

Conclusions

References

Tables

Figures

⏪

⏩

◀

▶

Back

Close

Full Screen / Esc

Printer-friendly Version

Interactive Discussion

Soils apart
equilibrium
modellingT. Wutzler and
M. Reichstein

Fig. 8. Difference of carbon stocks from base line (standard parameterization, $r_{Hum2}=0.0012$) after 100 years (y-axis) caused by different parameterization of the decay rate of the slowest pool (logarithmic x-axis). The four panels correspond to different scenario groups (base: no change, litter: increase litter input, t3: increased temperature).

Title Page

Abstract

Introduction

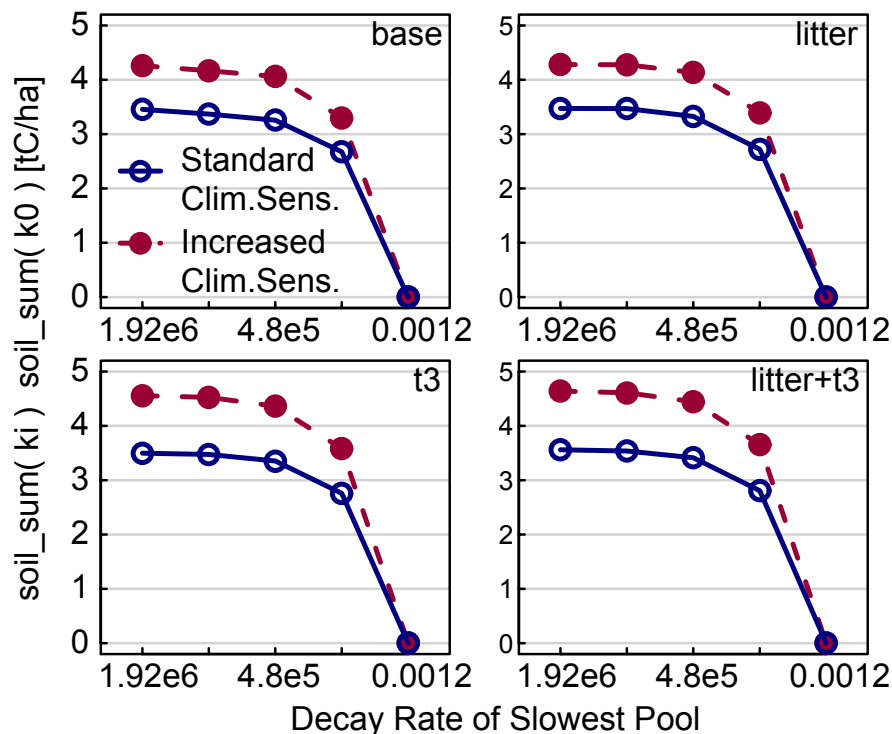
Conclusions

References

Tables

Figures

◀

▶

◀

▶

Back

Close

Full Screen / Esc

Printer-friendly Version

Interactive Discussion