



HAL
open science

A field-based method for simultaneous measurements of the $\delta^{18}\text{O}$ and $\delta^{13}\text{C}$ of soil CO_2 efflux

B. Mortazavi, J. L. Prater, J. P. Chanton

► **To cite this version:**

B. Mortazavi, J. L. Prater, J. P. Chanton. A field-based method for simultaneous measurements of the $\delta^{18}\text{O}$ and $\delta^{13}\text{C}$ of soil CO_2 efflux. *Biogeosciences*, 2004, 1 (1), pp.1-9. <hal-00297493>

HAL Id: hal-00297493

<https://hal.science/hal-00297493v1>

Submitted on 18 Jun 2008

HAL is a multi-disciplinary open access archive for the deposit and dissemination of scientific research documents, whether they are published or not. The documents may come from teaching and research institutions in France or abroad, or from public or private research centers.

L'archive ouverte pluridisciplinaire **HAL**, est destinée au dépôt et à la diffusion de documents scientifiques de niveau recherche, publiés ou non, émanant des établissements d'enseignement et de recherche français ou étrangers, des laboratoires publics ou privés.



HAL Authorization

A field-based method for simultaneous measurements of the $\delta^{18}\text{O}$ and $\delta^{13}\text{C}$ of soil CO_2 efflux

B. Mortazavi, J. L. Prater, and J. P. Chanton

Florida State University, Department of Oceanography, Tallahassee, FL 32306-4320, USA

Received: 11 March 2004 – Published in Biogeosciences Discussions: 11 May 2004

Revised: 4 August 2004 – Accepted: 5 August 2004 – Published: 13 August 2004

Abstract. Three approaches for determining the stable isotopic composition ($\delta^{13}\text{C}$ and $\delta^{18}\text{O}$) of soil CO_2 efflux were compared. A new technique employed mini-towers, constructed of open-topped piping, that were placed on the soil surface to collect soil-emitted CO_2 . Samples were collected along a vertical gradient and analyzed for CO_2 concentration and isotopic composition. These data were then used to produce Keeling plots to determine the $\delta^{18}\text{O}$ and $\delta^{13}\text{C}$ of CO_2 emitted from the soil. These results were then compared to the $\delta^{18}\text{O}$ and $\delta^{13}\text{C}$ of soil-respired CO_2 measured with two other techniques: (1) flux chambers and (2) estimation from the application of the diffusional fractionation factor to measured values of below ground soil CO_2 and to CO_2 in equilibrium with soil water $\delta^{18}\text{O}$. Mini-tower $\delta^{18}\text{O}$ Keeling plots were linear and highly significant ($0.81 < r^2 < 0.96$), in contrast to chamber $\delta^{18}\text{O}$ Keeling plots, which showed significant curvature, necessitating the use of a mass balance to calculate the $\delta^{18}\text{O}$ of respired CO_2 . In the chambers, the values determined for the $\delta^{18}\text{O}$ of soil respired CO_2 approached the value of CO_2 in equilibrium with surficial soil water, and the results were significantly $\delta^{18}\text{O}$ enriched relative to the mini-tower results and the $\delta^{18}\text{O}$ of soil CO_2 efflux determined from soil CO_2 . There were close agreements between the three methods for the determination of the $\delta^{13}\text{C}$ of soil efflux CO_2 . Results suggest that the mini-towers can be effectively used in the field for determining the $\delta^{18}\text{O}$ and the $\delta^{13}\text{C}$ of soil-respired CO_2 .

1 Introduction

Stable isotopes of CO_2 (^{18}O and ^{13}C) provide information on carbon exchange between the biosphere and the atmosphere (Francey et al., 1995; Keeling et al., 1995), and insight into

Correspondence to: B. Mortazavi
(mortazavi@ocean.fsu.edu)

the role of photosynthesis and respiration in the global carbon cycle (Yakir and Sternberg, 2000). Global carbon budgets using the ^{18}O of atmospheric CO_2 and CO_2 concentrations (Ciais et al., 1997; Ciais and Meijer, 1998; Peylin et al., 1999) have indicated that soil and plant isotopic fluxes each contribute roughly five times more to the observed temporal variability in the atmospheric $\delta^{18}\text{O}\text{-CO}_2$ than do oceanic or fossil fuel burning components (Miller et al., 1999). Because the global and regional scale carbon budgets include a flux of CO_2 from the soil to the atmosphere, the determination of the isotopic composition of soil CO_2 efflux remains a critical parameter to be measured in these budgets (Ciais and Meijer, 1998; Stern et al., 1999). At ecosystem and regional scales, accurate determination of the isotopic composition of soil respired CO_2 is necessary for partitioning ecosystem gas exchange into its components (Yakir and Wang, 1996; Bowling et al., 2003b).

Different approaches have been used to determine the isotopic composition of soil CO_2 efflux. In the laboratory setting, dynamic flow-through chambers have been used to estimate the ^{18}O of soil CO_2 efflux (Miller et al., 1999). In the field, chambers have been used to measure the ^{18}O (Högberg and Ekblad, 1996; Flanagan et al., 1999; Lin et al., 1999) and the ^{13}C of soil respired CO_2 (Flanagan et al., 1999; Ekblad and Hogberg, 2000; Ekblad et al., 2002; Mortazavi and Chanton, 2002a; Fessenden and Ehleringer, 2003). However, with application of chambers, the CO_2 concentration gradient from the soil to the atmosphere is disturbed and the ^{18}O of chamber headspace can remain constant despite addition of excess CO_2 by soil respiration (Mortazavi and Chanton, 2002a). Alternatively, Mortazavi and Chanton (2002a) assumed that all CO_2 at ground level originated from soil respiration and used a mass balance approach between daytime and nighttime CO_2 near the soil surface to determine the ^{18}O of CO_2 added by soil respiration.

Information about soil $^{18}\text{O}\text{-CO}_2$ has also been used to estimate the ^{18}O of soil CO_2 efflux (Mortazavi and Chanton,

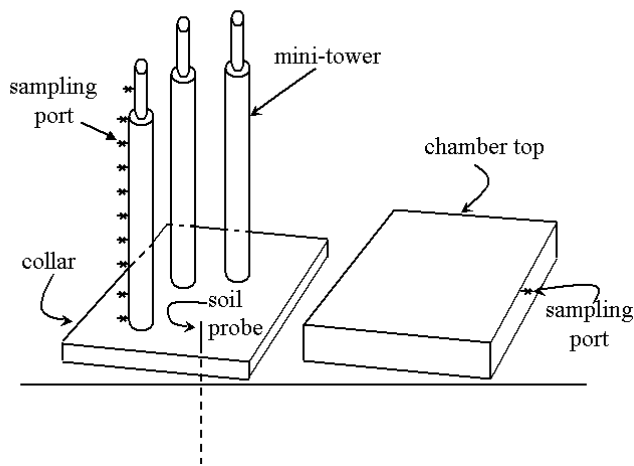
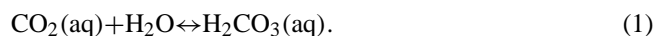
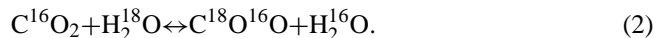

Fig. 1. Schematic of the different approaches used to measure CO_2 efflux. The chamber collar (65 cm by 65 cm) is inserted into the soil surface. Mini-towers (length = 202 cm, base diameter = 7.68 cm) are placed within the confines of the collar, and after 2 min, soil CO_2 is collected at multiple heights along the towers. The mini-towers are removed and then the chamber is sealed and headspace is collected over a 21 min time interval. Finally, a soil probe is inserted to predetermined depths for collecting soil CO_2 .

2002a; Bowling et al., 2003b). Soil CO_2 undergoes some degree of oxygen isotope exchange with soil water during the following reversible reaction:



In this hydration reaction and subsequent dissociation, each CO_2 molecule exchanges one oxygen atom with liquid water, and in this process the oxygen isotope ratio of CO_2 approaches that of soil water (Mills and Urey, 1940). The isotope exchange reaction is described by the following reaction:



The laboratory data of Miller et al. (1999) suggested that the region between 5–15 cm below the soil surface has the greatest influence on the $\delta^{18}\text{O}$ of soil-respired CO_2 . Below 15 cm the oxygen isotopic composition of CO_2 is reset by equilibrium with H_2O . Above 5 cm CO_2 transfer from the soil to the atmosphere is too rapid for CO_2 to be influenced by surface soil H_2O . A diffusional fractionation factor is, therefore, applied to soil CO_2 at the 5–15 cm region for determination of the ^{18}O of soil CO_2 efflux (e.g. Mortazavi and Chanton, 2002a). In the field, because of the lack of specific knowledge of the depth at which CO_2 is in equilibrium with soil CO_2 and the effective diffusional fractionation, the ^{18}O of soil CO_2 efflux has been estimated by applying the maximum diffusional fractionation factor to the ^{18}O of soil CO_2 that would be in equilibrium with integrated soil water between the surface and 10 cm depth (Bowling et al., 2003b).

The correct estimate of the ^{18}O of soil CO_2 efflux, however, will depend on (i) the extent to which CO_2 diffusing out of a particular layer reaches equilibrium or will be in disequilibrium with water in that layer (Tans, 1998), and (ii) the magnitude of the ^{18}O fractionation factor. It is not clear if the 8.8‰ molecular diffusion fractionation factor is always fully expressed as CO_2 diffuses from the soil to the atmosphere (Miller et al., 1999). Laboratory investigations (Miller et al., 1999) and modeling efforts (Stern et al., 2001) suggest that the effective diffusional fractionation factor will vary depending on the environmental conditions. Error in the estimation of the oxygen isotopic ratio of soil respired CO_2 will impact the results of studies that use the stable isotopes of CO_2 to partition ecosystem gas exchange into its components (Yakir and Wang, 1996; Bowling et al., 2003b).

The ^{13}C of soil respired CO_2 has also been estimated from soil CO_2 concentrations and ^{13}C ratios. A fractionation factor of 4.4‰ (Cerling et al., 1991) is applied to the soil CO_2 Keeling intercept to account for the lighter CO_2 molecules escaping faster. However, discrepancies can exist between soil CO_2 and chamber-based estimates (Mortazavi and Chanton, 2002a). This discrepancy could result because chamber-based estimates integrate the litter layer respiration whereas the soil CO_2 estimates ignore the contribution of surface respired material to the isotopic composition of CO_2 efflux.

Our objectives were to use an alternative method to static chambers and soil CO_2 to simultaneously determine the ^{18}O and ^{13}C of soil respired CO_2 in the field. We used open-top piping (mini-towers) placed on the soil surface and collected gas samples along the height of the mini-tower as CO_2 diffused from the soil. A Keeling plot of the CO_2 concentrations and isotopic ratios of samples collected from multiple heights was used to estimate the isotopic composition of soil respired CO_2 . Results indicate that the mini-tower approach can be used successfully to simultaneously determine the ^{18}O and ^{13}C of soil CO_2 efflux.

2 Methods

The investigation was conducted at the Apalachicola National forest (30°20′0.433″ N and 84°19′0.173″ W) near Tallahassee, FL. The site is dominated by second growth slash pine (*Pinus elliotii*). The site was visited on 2 June 2003 and 23 June 2003. Two locations (within 50 m of each other) were sampled during each visit. Upon the second visit, samples were collected within 2 m of the locations previously sampled.

2.1 Mini-tower

Towers were constructed from polyvinyl chloride (PVC) piping. The piping consists of a 7.68 cm inner diameter PVC 150 cm long connected via a reducer to a 3.84 cm PVC pipe 48 cm long (Fig. 1). The total length of the mini-tower is

202 cm. The top of the mini-tower is left open to the atmosphere. Sampling ports equipped with valves were installed at 5, 10, 20, 40, 60, 80, 100, 120, 140, and 179 cm from the ground level. The tower's base was beveled and could be gently inserted 0.5 cm into the soil surface. Prior to installing the mini-towers they were thoroughly flushed with background air and all the valves were closed. After a 2 min period following the installation of the mini-towers, samples were sequentially collected during a 15 min period from the base towards the top. Samples were withdrawn with a syringe and stored in pre-evacuated glass vials (30 ml) capped with Belco[®] stoppers (Mortazavi and Chanton, 2002b). An in-line magnesium perchlorate trap was used when withdrawing samples to remove moisture. A Keeling plot was used to estimate the ^{18}O and ^{13}C of soil CO_2 efflux. During the 23 June 2003 sampling, after placing the tower on the soil surface an initial sample was taken at 179 cm, and then we proceeded as previously described. This allowed a wider range in CO_2 concentration, which functioned to reduce the standard error of the intercept of the Keeling plots (Pataki et al., 2003).

2.2 Chamber measurements

The chambers have the dimensions of 65 cm by 65 cm and are constructed from aluminum. The chambers consist of a collar onto which the top portion can be sealed (Fig. 1). The total enclosed volume is 100 l. The collar is initially inserted into the ground and the chamber top, equipped with a fan to recirculate the headspace, is lowered and sealed. Replicate gas samples (125 ml) from the chamber headspace were drawn with a syringe and stored in pre-evacuated glass vials with Belco[®] stoppers for later analysis (Mortazavi and Chanton, 2002b). Replicate samples were collected at time 0 and every 7 min during a 21 min period for CO_2 concentration determination and isotopic analysis. A port was left open at the opposite side from the sampling port during sample withdrawal to minimize pressure fluctuations inside the chambers. An in-line magnesium perchlorate trap was used to remove water vapor during the sample collection. CO_2 concentration increase with time in the chamber headspace was used to determine soil respiration rates.

2.3 Soil CO_2 profile

We collected duplicate soil gas samples for CO_2 concentration and isotopic analysis with a stainless steel probe (0.32 cm outer diameter) inserted at discrete depths (10, 25, 45 and 84 cm below the surface). At each depth, duplicate samples were collected. Samples were gently drawn with a syringe and stored in pre-evacuated glass vials (25 ml) capped with Belco[®] stoppers for later analysis. An in-line magnesium perchlorate trap was used to remove moisture from the samples during sample withdrawal.

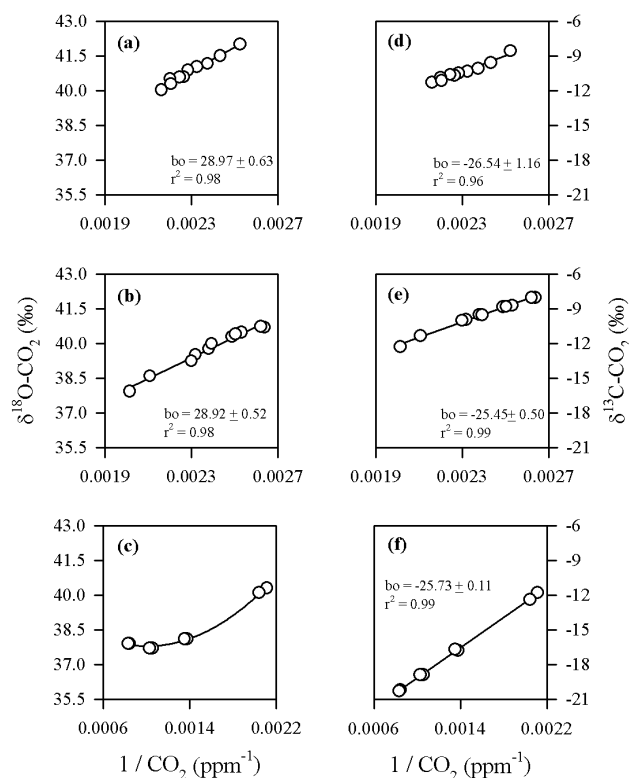

Fig. 2. Examples of $\delta^{18}\text{O}$ and $\delta^{13}\text{C}$ Keeling plots for mini-towers and chambers. (a) $\delta^{18}\text{O}$ Keeling plot for mini-tower #3, site 1, on 2 June 2003. (b) $\delta^{18}\text{O}$ Keeling plot for mini-tower #2, site 1, on 23 June 2003. (c) $\delta^{18}\text{O}$ of CO_2 versus its respective $1/\text{CO}_2$ concentration for chamber 1, site 1, on 2 June 2003. The fitted line is a second order polynomial. (d) $\delta^{13}\text{C}$ Keeling plot for mini-tower #3, site 1, on 2 June 2003. (e) $\delta^{13}\text{C}$ Keeling plot for mini-tower #2, site 1, on 23 June 2003. (f) $\delta^{13}\text{C}$ Keeling plot for chamber 1, site 1, on 2 June 2003.

2.4 Sequence of sampling

Upon arrival at each location, the chamber collar was gently pushed into the sandy soils. The collar is left for 30 min to minimize any disturbance caused by inserting the collar. Mini-towers ($n=3$) were placed at different locations within the area encompassed by the chamber collar and height profiles were collected. Next, the chamber was sealed to the collar and the chamber measurements commenced. The same procedure was applied at the second site. The soil probe was inserted to the predetermined depths to collect soil CO_2 after a 45 min period following the chamber measurements (Fig. 1).

At each site, soil samples were collected at the surface (0–2 cm) and at a depth of 10–12 cm for soil water extraction for $^{18}\text{O}-\text{H}_2\text{O}$ analyses. Samples were stored in glass vials and capped and kept frozen until extraction. Surface soil and soil samples at 10, 25, 45 and 84 cm below the surface were collected for soil organic matter ^{13}C determination and kept frozen until processed in the laboratory.

Table 1. $\delta^{18}\text{O}$ (‰) of soil CO_2 efflux in Apalachicola National Forest. For the chambers a mass balance was used to calculate the ^{18}O of soil CO_2 efflux between 10 and 7 min, between 27 and 14 min, and between 314 and 21 min. 4 An 8.8‰ fractionation factor was applied to soil CO_2 at 10 cm to calculate the ^{18}O of soil CO_2 efflux. The error corresponds to half the range of variability of duplicate soil ^{18}O - CO_2 samples. 5 An 8.8‰ fractionation factor was applied to the ^{18}O of CO_2 assumed in equilibrium with soil water extracted from soil samples collected at 10–12 cm depth (mean \pm standard deviation of triplicate samples) to calculate the ^{18}O of soil CO_2 efflux. The numbers in the parentheses indicate the sample numbers used in the regression and the r^2 , respectively). The values for the mini-towers represent the intercept of the Keeling plot and the SE. For mean mini-towers the error has been propagated. With the exception of site 2 on 2 June 2003, $\delta^{18}\text{O}$ of soil CO_2 flux determined with the mini-towers ($n=3$) and that determined from soil water ($n=3$) were significantly different (t-test, $\alpha=0.05$).

Date	Method	Site 1	Site 2
2 June 2003	Mini-tower #1	27.32 \pm 0.65 (10, 0.94)	25.83 \pm 2.28 (10, 0.75)
2 June 2003	Mini-tower #2	27.91 \pm 0.98 (10, 0.98)	29.24 \pm 0.87 (10, 0.96)
2 June 2003	Mini-tower #3	28.97 \pm 0.63 (10, 0.93)	24.33 \pm 1.96 (10, 0.89)
2 June 2003	Mean Mini-tower	28.07 \pm 1.33	26.47 \pm 3.13
2 June 2003	Chamber	34.06 ¹ , 36.59 ² , 38.72 ³	31.44 ¹ , 34.22 ² , 36.15 ³
2 June 2003	Soil CO_2	31.00 \pm 0.00 ⁴	28.49 \pm 0.10 ⁴
2 June 2003	Soil Water	31.88 \pm 0.08 ⁵	28.78 \pm 0.30 ⁵
23 June 2003	Mini-tower #1	27.68 \pm 0.99 (11, 0.94)	29.52 \pm 1.61 (11, 0.81)
23 June 2003	Mini-tower #2	28.92 \pm 0.52 (11, 0.98)	27.53 \pm 1.29 (11, 0.97)
23 June 2003	Mini-tower #3	26.00 \pm 1.19 (11, 0.93)	30.68 \pm 1.13 (11, 0.88)
23 June 2003	Mean Mini-tower	27.52 \pm 1.63	29.25 \pm 2.35
23 June 2003	Chamber	32.78 ¹ , 35.84 ² , 36.87 ³	32.07 ¹ , 35.01 ² , 36.70 ³
23 June 2003	Soil CO_2	25.20 \pm 0.00 ⁴	25.37 \pm 0.80 ⁴
23 June 2003	Soil Water	24.92 \pm 0.30 ⁵	25.89 \pm 0.19 ⁵

2.5 Stable isotope analyses

The ^{18}O and ^{13}C of CO_2 for samples collected along the mini-towers and from the flux chambers were determined with a GC-IRMS (Gas Chromatograph: Hewlett Packard 5890 Series II, Isotope Ratio Mass Spectrometer: Finnigan Delta S) operating in continuous flow mode. We applied a simple modification to a commercially available GC-IRMS for rapid and precise determination of stable isotopes of CO_2 and CO_2 concentrations. For a full description of the method see Mortazavi and Chanton (2000b). The CO_2 concentrations from the soil CO_2 flux chambers and the mini-towers were determined from the CO_2 voltages obtained from the GC-IRMS (Mortazavi and Chanton, 2002b). Soil CO_2^{18}O and ^{13}C were determined by direct injection of 0.2 ml samples into the GC-IRMS. Soil CO_2 concentrations were determined with a LI-COR 6200 (LI-COR Inc., Lincoln, Neb) according to the procedures described by Davidson and Trumbore (1995).

Water was extracted by cryogenic vacuum distillation from soil samples according to the procedures described by Ehleringer et al. (2000). A sub-sample of the extracted water (0.5 ml) was equilibrated in a vial with 1% CO_2 headspace, and the ^{18}O of the headspace was analyzed after 48 h of incubation at 25°C for ^{18}O on the GC-IRMS by direct injection of 0.2 ml of the headspace CO_2 (Socki et al., 1992).

Soil samples were dried at 60°C to constant mass and roots

were removed. Root free soil samples were then ground with a pestle and mortar. Samples were acidified (0.5 N HCl, for 24 h) to remove carbonates (Rask and Schoenau, 1993). Samples were thoroughly washed with distilled water and dried to constant mass and ground with a pestle and mortar. Subsamples were analyzed for ^{13}C in duplicate on a CHN analyzer coupled to the IRMS.

Isotopic ratio data are presented in the δ notation, and are reported relative to PDB for $\delta^{13}\text{C}$ and SMOW for $\delta^{18}\text{O}$. External precision for isotopic measurements was ± 0.2 based on repeated measurements of laboratory-working standards.

2.6 Statistical considerations

The isotopic composition of soil respired CO_2 was determined with application of Keeling plots to the mini-tower and chamber CO_2 concentrations and isotopic ratios. The ^{13}C of soil-respired CO_2 from soil CO_2 was determined by subtracting the 4.4‰ diffusional fractionation factor (Cerling et al., 1991) from the intercept of soil CO_2 Keeling plots. We used a Model II regression (geometric mean regression, Sokal and Rohlf, 1981) to estimate the intercept of the Keeling plots. The standard error of the intercept of a model I regression is used to approximate the error estimate for the model II intercept (Sokal and Rohlf, 1981; Pataki et al., 2003).

Table 2. The $\delta^{18}\text{O}$ (‰) of CO_2 at equilibrium with surficial soil water (0–2 cm depth) and soil water at 10–12 cm depth. The error corresponds to the standard deviation of triplicate soil water samples. * For comparison the measured value of soil $\delta^{18}\text{CO}_2$ collected at 10 cm is also shown (mean $\pm 1/2$ range of duplicate measurements).

Date	Site 1		Site 2	
	0–2 cm	10–12 cm	0–2 cm	10–12 cm
2 June 2003	41.29 \pm 0.30	40.69 \pm 0.08	40.64 \pm 0.40	37.58 \pm 0.30
		39.50 \pm 0.00*		37.30 \pm 0.14*
23 June 2003	35.93 \pm 0.60	33.72 \pm 0.30	37.40 \pm 0.33	34.69 \pm 0.19
		34.00 \pm 0.00*		34.17 \pm 0.79*

3 Results and discussion

3.1 ^{18}O of soil respired CO_2

CO_2 concentration in the mini-tower profiles increased above background values by 82.6 ppm at site 1 and by 56.7 ppm on 2 June 2003 and by 104.8 ppm at site 1 and by 59.4 ppm at site 2 on 23 June 2003 (data not shown). The average CO_2 concentration difference between the highest point in the mini tower sampled (179 cm) and the background was 18 ppm. With a CO_2 diffusion coefficient of $0.16\text{ cm}^2\text{ s}^{-1}$ (Massman, 1998), CO_2 loss by diffusion from the top to the chamber was two orders of magnitude lower than CO_2 addition by soil respiration ($4.47\pm 1.41\ \mu\text{mole m}^{-2}\text{ s}^{-1}$, $n=4$). Therefore, the selective loss of the lighter isotopes of CO_2 from the top by diffusion could be ignored.

The mini-tower ^{18}O Keeling plots were linear, highly significant ($p<0.01$), and had r^2 values ranging from 0.81 to 0.96 (Fig. 2, Table 1). Mean $\delta^{18}\text{CO}_2$ values for the two adjacent sites combined varied from $27.27\text{‰}\pm 1.89$ ($n=6$, 1SD) to $28.39\text{‰}\pm 1.65$ ($n=6$, 1SD) on 2 and 23 June 2003, respectively. There were several per mil differences in the ^{18}O of soil CO_2 efflux determined with the mini-towers within the confines of the chamber collar at each location (Table 1). This difference could reflect heterogeneity in soil water or differences in the effective diffusional fractionation factor associated with CO_2 flux from the soil to the atmosphere.

In contrast to the mini-tower Keeling plots, there was significant curvature in the chamber ^{18}O Keeling plots during all sampling periods (Fig. 2c). Therefore, an alternative procedure was used to estimate the ^{18}O of CO_2 added relative to background concentrations between time points. CO_2 concentration at time t (Ct) is a combination of CO_2 at time zero (Co) to which a certain amount of CO_2 has been added (Ca) by respiration (Eq. 1). The isotopic composition of CO_2 at time t (δt) is a product of the combination of $Co\delta o$ and $Ca\delta a$ (2).

$$Ct = Co + Ca \quad (3)$$

$$Ct\delta t = Co\delta o + Ca\delta a \quad (4)$$

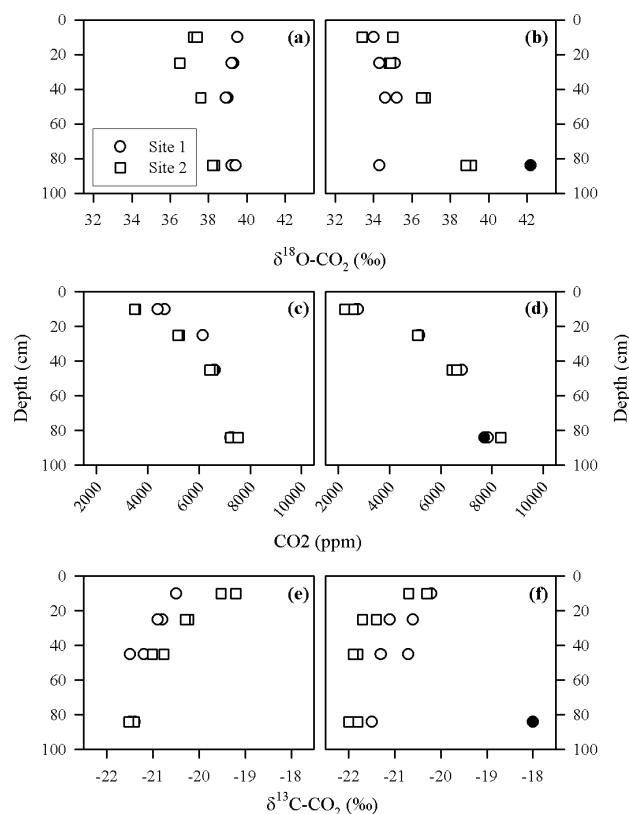

Fig. 3. Depth profiles of soil CO_2 concentration measured on (a) 2 June 2003 and (b) 6/23/03. Depth profiles of soil $\delta^{18}\text{O}\text{-CO}_2$ (c) 2 June 2003 and (d) 23 June 2003. Depth profiles of soil $\delta^{13}\text{C}\text{-CO}_2$ on (e) 2 June 2003 and (f) 23 June 2003. The closed symbol was excluded from the regression of the ^{13}C Keeling plot (Table 3).

By measuring Co , Ct , δo and δt , δa could be calculated between two time points. We calculated the ^{18}O of CO_2 added by soil respiration between 0–7, 7–14 and 14–21 min in each chamber by using Eqs. (3) and (4) (Table 1). There was progressive enrichment in the ^{18}O of CO_2 in the chamber headspace with time (Table 1). The ^{18}O of soil respired CO_2 approached a value similar to that for CO_2 in equilibrium with surface soil water (Table 2). The estimates from the chambers at even the shortest time interval (7 min) were enriched by several per mil relative to the mini-tower Keeling intercepts (Table 1).

Our time frame for chamber deployment is similar to that used by Lin et al. (1999), who used a mass balance equation to determine the ^{18}O of respired CO_2 in a chamber headspace. The results (Table 1) indicate that the time frame considered for calculating the ^{18}O of respired CO_2 from chamber data may be extremely important and highlight the influence of surface soil water on the estimate of the soil $\delta^{18}\text{CO}_2$ efflux when using chambers. Flanagan et al. (1999) used chambers over short time frames during which the CO_2 concentrations built up in the chamber headspace were sim-

Table 3. $\delta^{13}\text{C}$ (‰) of soil CO_2 efflux in Apalachicola National Forest. *A 4.4‰ fractionation factor has been applied to the intercept of soil Keeling plot to determine the ^{13}C of soil CO_2 efflux. ** An outlier was excluded from the regression (see Fig. 3f). The numbers in the parentheses indicate the sample numbers used in the regression and the r^2 , respectively. Estimates of $\delta^{13}\text{C}$ of soil CO_2 flux determined with the chambers and the mini-towers ($n=3$) were not different (t-test, $\alpha=0.05$). The values for the mini-towers correspond to the intercept of the Keeling plot and the standard error. The standard errors were propagated for the calculation of mean for the mini-towers. With the exception of site 1 on 23 June 2003, estimates of the $\delta^{13}\text{C}$ of soil CO_2 flux determined with the chambers and with soil CO_2 Keeling plots were significantly different (t-test, $\alpha=0.05$).

Date	Method	Site 1	Site 2
2 June 2003	Mini-tower #1	-27.16 ± 1.17 (10, 0.96)	-28.94 ± 2.02 (10, 0.92)
2 June 2003	Mini-tower #2	-26.57 ± 1.25 (10, 0.95)	-24.04 ± 0.83 (10, 0.98)
2 June 2003	Mini-tower #3	-26.54 ± 1.16 (10, 0.96)	-26.59 ± 1.85 (10, 0.91)
2 June 2003	Mean Mini-tower	-26.76 ± 2.07	-26.52 ± 2.86
2 June 2003	Chamber	-25.73 ± 0.11 (8, 0.99)	-25.89 ± 0.30 (8, 0.99)
2 June 2003	Soil CO_2	$-27.19 \pm 0.34^*$ (8, 0.82)	-27.30 ± 0.30 (8, 0.93)
23 June 2003	Mini-tower #1	-26.80 ± 0.64 (11, 0.99)	-26.30 ± 1.14 (11, 0.96)
23 June 2003	Mini-tower #2	-25.45 ± 0.50 (11, 0.99)	-27.04 ± 1.37 (11, 0.095)
23 June 2003	Mini-tower #3	-26.93 ± 0.74 (11, 0.98)	-23.60 ± 0.91 (11, 0.96)
23 June 2003	Mean Mini-tower	-26.39 ± 1.10	-25.64 ± 2.00
23 June 2003	Chamber	-26.05 ± 0.18 (8, 0.99)	-26.15 ± 0.31 (8, 0.99)
23 June 2003	Soil CO_2	$-26.06 \pm 0.26^*$ (7, 0.76)**	-26.75 ± 0.18 (8, 0.88)

ilar to CO_2 increases in the mini-towers. That investigation was conducted in moss-covered boreal forest soil, and significant ^{18}O Keeling regressions were obtained. These authors, however, noted the importance of soil type on the ^{18}O of soil CO_2 efflux.

The dominant factor controlling the ^{18}O of soil CO_2 is equilibrium with soil water (Miller et al., 1999). However, in field studies both equilibrium and disequilibrium have been reported (Hesterberg and Siegenthaler, 1991; Amundson and Wang, 1995; Mortazavi and Chanton, 2002a). At our study site, the $\delta^{18}\text{O}$ of soil CO_2 was in close equilibrium with soil water ^{18}O at the 10–12 cm depth (Table 2).

We determined the ^{18}O of soil CO_2 efflux by applying the diffusional fractionation factor to soil CO_2 and to CO_2 in oxygen isotopic equilibrium with soil water at 10 cm (Fig. 3). With the exception of site 2 on 23 June 2003, the estimates of soil $\delta^{18}\text{O}\text{-CO}_2$ flux were significantly different (t-test, $\alpha=0.05$). Because detailed laboratory investigations are required to estimate the effective diffusional fractionation factor (Miller et al., 1999), we applied the maximum diffusional fractionation factor of 8.8‰. The ^{18}O of soil CO_2 varied from 36.5‰ to 39.5‰ on 2 June 2003 and from 33.4 to 42.2‰ on 23 June 2003 (Fig. 3). Estimates based on soil $^{18}\text{O}\text{-CO}_2$ to which the fractionation factor has been applied to determine the ^{18}O of soil CO_2 efflux bracketed the mini-tower values over the two sampling dates. Calculated values were enriched relative to the value measured with the mini-towers on 2 June 2003 (Table 1). In contrast, on 23 June 2003, the ^{18}O of soil CO_2 efflux estimated from soil CO_2 was depleted relative to the estimates from the mini-towers (Table 1).

The discrepancy between the estimates of the isotopic composition of soil CO_2 efflux based on soil CO_2 from the mini-tower could result from several factors. The results from the analytical model developed by Stern et al. (1999) suggest that although ^{18}O of soil water dominated the ^{18}O of soil CO_2 , other factors such as soil respiration rates, respiration distribution within the soil, and advective transport contribute to the ^{18}O of soil CO_2 efflux. Additionally, we applied the maximum diffusional fractionation factor, which could differ from the effective diffusional fractionation factor (Miller et al., 1999). The mini-tower approach provides an effective way to measure the ^{18}O of soil respired CO_2 that does not involve application of assumed values for the fractionation factor.

3.2 ^{13}C of soil respired CO_2

Examples from the mini-towers ^{13}C Keeling plots are shown in Fig. 2. ^{13}C Keeling plots from the mini-towers were highly significant (Table 3, $r^2 > 0.91$). The $\delta^{13}\text{C}$ of soil efflux determined with the mini towers were on 2 June 2003, $-26.76\text{‰} \pm 2.07$ and $-26.52\text{‰} \pm 2.86$ at site 1 and 2, respectively on 23 June 2003 were $-26.39\text{‰} \pm 1.10$ and $-25.64\text{‰} \pm 2.00$ at site 1 and 2, respectively (Table 3). The standard errors of the Keeling intercepts of the mini-towers were greater than those for the chambers (Table 3) due to the shorter duration of the mini-tower experiments (2 min). The standard error of the Keeling intercepts declined with increasing range in CO_2 concentrations for each set of flasks used in the regression (Fig. 4), a trend similar to that reported for canopy-scale Keeling plots (Bowling et al., 2003a; Pataki et al., 2003).

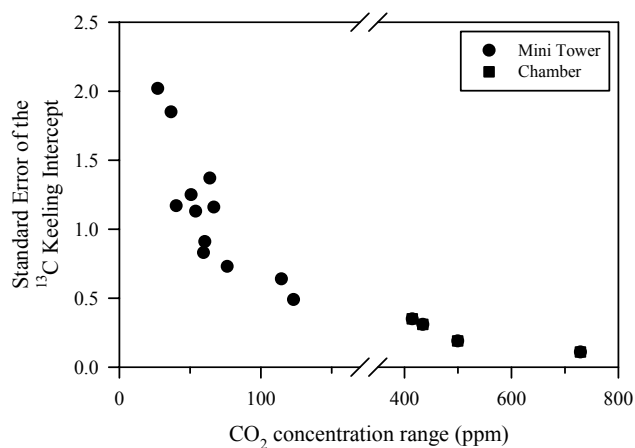

Fig. 4. Standard error of the $\delta^{13}\text{C}$ Keeling intercepts as a function of the range in CO_2 concentrations for each set of flasks used in the regression.

CO_2 concentrations increased linearly during the chamber incubation on all attempts ($r^2=0.99$, data not shown) and were used to estimate soil respiration rates. Respiration rates were greater at site 1 compared to site 2 by 75% on 2 June 2003 and 21% and 23 June 2003 (data not shown). ^{13}C Keeling plots for the chamber data (Fig. 2, Table 3) were highly significant and had mean intercepts ($n=2$) of -25.8% and -26.1% on 2 and 23 June 2003, respectively (Table 3). There was not a significant difference between the chamber based estimates of the $\delta^{13}\text{C}$ of soil CO_2 flux and the mini-tower estimates (t-test, $\alpha=0.05$).

The $\delta^{13}\text{C}$ of soil CO_2 efflux was also determined from soil CO_2 profiles (Fig. 3). The range of CO_2 concentrations varied from 3475 to 7530 ppm on 2 June 2003 and from 2243 to 8345 ppm on 23 June 2003 (Fig. 3). $\delta^{13}\text{C}$ of soil CO_2 decreased with increasing depth and varied from -19.2 to -21.53% on 2 June 2003, and from -20.2 to -22% on 23 June 2003 (Fig. 3). The ^{13}C Keeling plots were highly significant and yielded intercepts that varied by less than 0.7% between the two sites during each visit (Table 3). There was a slight depletion in the ^{13}C of soil CO_2 flux based on soil CO_2 profiles on 23 June 2003, ($-27.19\% \pm 0.34$ and $-27.30\% \pm 0.30$ for site 1 and 2, respectively, Table 3) compared to 2 June 2003, ($-26.06\% \pm 0.26$ and $-26.75\% \pm 0.18$, for site 1 and 2, respectively, Table 3). The $\delta^{13}\text{C}$ of soil CO_2 flux determined from soil CO_2 and that determined with the chambers were significantly different except at site 1 on 23 June 2003 (t-test, $\alpha=0.05$).

Mini-tower and chamber-based measurements of the $\delta^{13}\text{C}$ of soil-respired CO_2 have two advantages over estimates obtained from soil CO_2 profiles. First, in contrast to estimates based on soil CO_2 profiles that are generated from samples collected below the surface soil layer, mini-tower and chamber based estimates include the influence of litter respiration and the first few centimeters of the surface soil layer on the

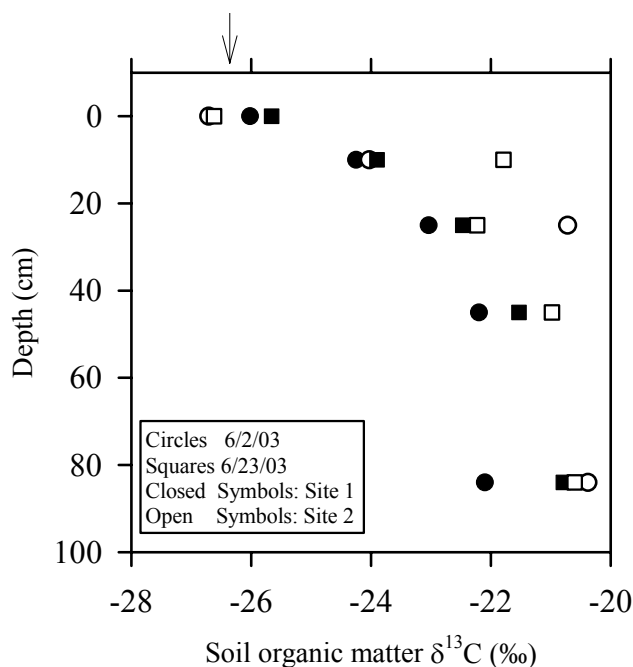

Fig. 5. The soil organic matter $\delta^{13}\text{C}$ (root free soil samples). The arrow on the x-axis indicates the mean ($n=12$) of the $\delta^{13}\text{C}$ of soil CO_2 flux determined from the mini-tower intercepts.

^{13}C of soil-respired CO_2 . Second, estimates of the $\delta^{13}\text{C}$ of soil CO_2 efflux based on the chambers and the mini-towers do not require the application of a fractionation factor for CO_2 diffusion.

The $\delta^{13}\text{C}$ of soil respired CO_2 results from a combination of heterotrophic and autotrophic respiration. A profile of soil organic matter $\delta^{13}\text{C}$ demonstrates a progressive enrichment in ^{13}C from a value of $-26.2\% \pm 0.5$ (1 SD, $n=4$) at the surface to a value of $-22.4\% \pm 2.8$ (1SD, $n=4$) at 84 cm (Fig. 5). The mean value of the mini-tower Keeling intercepts (-26.3% , $n=12$) was remarkably close to the value of surface soil organic matter at this site (Fig. 5). While the $\delta^{13}\text{C}$ associated with heterotrophic respiration is assumed to remain constant on seasonal time scales (Trumbore, 2000) that of autotrophic respiration will vary in response to changes in environmental conditions (Ekblad and Högberg, 2001). Therefore, despite the similarity in the $\delta^{13}\text{C}$ of soil CO_2 efflux and the $\delta^{13}\text{C}$ of SOM (Fig. 5), the isotopic composition of soil organic matter is a poor predictor of the $\delta^{13}\text{C}$ of soil respired CO_2 .

4 Conclusions

The data suggests that chamber and soil- CO_2 -based estimates for determining the $\delta^{18}\text{O}$ of soil CO_2 efflux are biased, and that the mini-towers provide effective means for estimating the $\delta^{18}\text{O}$ of soil respired CO_2 . In contrast to the ^{18}O results, there were close agreements in the $\delta^{13}\text{C}$ of soil

CO_2 efflux measured with the mini-towers and the chambers. Investigations using the $\delta^{18}\text{O}$ of CO_2 for partitioning ecosystem CO_2 exchange into its components rely on accurate knowledge of the oxygen isotopic composition of soil-respired CO_2 . The mini-tower approach is cost-effective and provides a rapid means for determining the $\delta^{18}\text{O}$ and $\delta^{13}\text{C}$ of soil-respired CO_2 .

Acknowledgements. We would like to thank the assistance of K. Peeler in the field. We would like to thank M. Smith and K. Bryan and three anonymous referees for comments on the manuscript. Financial support was provided by the Biological and Environmental Research (BER) Program, US Department of Energy, through the Southeast Regional Center (SERC) of the National Institute for Global Environmental Change (NIGEC), through the Terrestrial Carbon Processes Program (TCP, DE-FG02-00ER63016) and by the National Science Foundation (NSF #0343604).

Edited by: S. V. Smith

References

- Amundson, R. and Wang, Y.: Relationship between the oxygen isotopic composition of soil CO_2 and water, In: Proceedings of a symposium on isotopes in water resources management, Vol. 1, International Atomic Energy Agency, Vienna, 315–332, 1995.
- Bowling, D. R., McDowell, N. G., Welker, J. M., Bond, B. J., Law, B. E., and Ehleringer, J. R.: Oxygen isotope content of CO_2 in nocturnal ecosystem respiration: 2. Short-term dynamics of foliar and soil component fluxes in an old-growth ponderosa pine forest, *Global Biogeochem. Cycles*, 17, doi:10.1029/2003GB002082, 2003a.
- Bowling, D. R., McDowell, N. G., Welker, J. M., Bond, B. J., Law, B. E., and Ehleringer, J. R.: Oxygen isotope content of CO_2 in nocturnal ecosystem respiration: 1. Observation in forests along a precipitation transect in Oregon, USA, *Global Biogeochem. Cycles*, 17, doi:10.1029/2003GB002081, 2003b.
- Cerling, T. E., Solomon, D. K., Quade, J., and Bowman, J. R.: On the isotopic composition of carbon in soil carbon-dioxide, *Geochim. Cosmochim. Acta*, 55, 3403–3405, 1991.
- Ciais, P., Denning, A. S., Tans, P. P., Berry, J. A., Randall, D. A., Collatz, G. J., Sellers, P. J., White, J. W. C., Trolier, M., Meijer, H. A. J., Francey, R. J., Monfrey, P., and Heimann, M.: A three-dimensional synthesis study of $\delta^{18}\text{O}$ in atmospheric CO_2 : 1. Surface fluxes, *J. Geophys. Res.*, 102, 5857–5872, 1997.
- Ciais, P. and Meijer, H. A. J.: The $^{18}\text{O}/^{16}\text{O}$ isotope ratio of atmospheric CO_2 and its role in global carbon cycle research, In: Stable Isotopes-Integration of biological ecological and geochemical processes, edited by Griffiths, H., Bios Scientific, Oxford, 203–221, 1998.
- Davidson, E. A. and Trumbore, S. E.: Gas diffusivity and production of CO_2 in deep soils of the eastern Amazon, *Tellus*, 47, 550–565, 1995.
- Ehleringer, J. R., Roden, J., and Dawson, T. E.: Assessing ecosystem-level water relations through stable isotope ratio analyses, In: Methods in ecosystem science, edited by Sala, O. E., Jackson, G. A., Mooney, A. H., Howarth, R. W., Springer-Verlag, New York, 181–198, 2000.
- Ekbald, A. and Högberg, P.: Natural abundance of ^{13}C in CO_2 respired from forest soils reveals speed of link between tree photosynthesis and root respiration, *Oecologia*, 127, 305–308, 2001.
- Fessenden, J. E. and Ehleringer, J. R.: Temporal variation in $\delta^{13}\text{C}$ of ecosystem respiration in the Pacific Northwest: links to moisture stress, *Oecologia*, 136, 129–136, 2003.
- Flanagan, L. B., Kubien, D. S., and Ehleringer, J. R.: Spatial and temporal variation in the carbon and oxygen stable isotope ratio of respired CO_2 in a boreal forest ecosystem, *Tellus*, 51, 367–384, 1999.
- Francey, R. J., Tans, P. P., Allison, C. E., Enting, I. G., White, J. W. C., and Trolier, M.: Changes in oceanic and terrestrial carbon uptake since 1982, *Nature*, 373, 326–330, 1995.
- Hesterberg, R. and Siegenthaler, U.: Production and stable isotopic composition Of CO_2 in a soil near Bern, Switzerland, *Tellus*, 43, 197–205, 1991.
- Keeling, C. D., Whorf, T. P., Wahlen, M., and Vanderpligt, J.: Interannual extremes in the rate of rise of atmospheric carbon dioxide since 1980, *Nature*, 375, 666–670, 1995.
- Lin, G. H., Ehleringer, J. R., Rygielwicz, P. T., Johnson, M. G., and Tingey, D. T.: Elevated CO_2 and temperature impacts on different components of soil CO_2 efflux in Douglas-fir terracosms, *Glob. Change Biol.*, 5, 157–168, 1999.
- Miller, J. B., Yakir, D., White, J. W. C., and Tans, P. P.: Measurements of $^{18}\text{O}/^{16}\text{O}$ in the soil-atmosphere CO_2 flux, *Global Biogeochem. Cycles*, 13, 761–774, 1999.
- Mills, G. A. and Urey, H. C.: The kinetics of isotope exchange between carbon dioxide, bicarbonate ion, carbonate ion and water, *Journal of American Chemical Society*, 62, 1019–1026, 1940.
- Mortazavi, B., and Chanton, J. P.: Carbon isotopic discrimination and control of nighttime canopy $\delta^{18}\text{O}\text{-CO}_2$ in a pine forest in the Southeastern US, *Global Biogeochem. Cycles*, 16, doi:10.1029/2000GB001390, 2002a.
- Mortazavi, B. and Chanton, J. P.: A rapid and precise technique for measuring $\delta^{13}\text{CO}_2$ and $\delta^{18}\text{CO}_2$ ratios at ambient CO_2 concentrations for biological applications and the influence of container type and storage time on the sample isotope ratios, *Rapid Commun. Mass Spectrom.*, 16, 1398–1403, 2002b.
- Pataki, D. E., Ehleringer, J. R., Flanagan, L. B., Yakir, D., Bowling, D. R., Still, C. J., Buchmann, N., Kaplan, J. O., and Berry, J. A.: The application and interpretation of Keeling plots in terrestrial carbon cycle research, *Global Biogeochem. Cycles*, 17, doi:10.1029/2001GB001850, 2003.
- Peylin, P., Ciais, P., Denning, A. S., Tans, P. P., Berry, J. A., and White, J. W. C.: A 3-dimensional study of $\delta^{18}\text{O}$ in atmospheric CO_2 : contribution of different land ecosystems, *Tellus*, 51, 642, 1999.
- Rask, H. M. and Schoenau, J. J.: ^{13}C natural abundance variations in carbonates and organic matter from boreal forest wetlands, *Biogeochemistry*, 22, 23–35, 1993.
- Socki, R. A., Karlsson, H. R., and Gibson, E. K.: Extraction technique for the determination of oxygen-18 in water using preevacuated glass vials, *Anal Chem*, 64, 829–831, 1992.
- Sokal, R. R. and Rohlf, F. J.: *Biometry*, W. H. Freeman and Company, New York, 859, 1981.
- Stern, L., Baisden, W. T., and Amundson, R.: Processes controlling the oxygen isotope ratio of soil CO_2 : Analytic and numerical modeling, *Geochim. Cosmochim. Acta*, 63, 799–814, 1999.
- Stern, L. A., Amundson, R., and Baisden, W. T.: Influence of soils

- on oxygen isotope ratio of atmospheric CO_2 , *Global Biogeochem. Cycles*, 15, 753–759, 2001.
- Tans, P. P.: Oxygen isotopic equilibrium between carbon dioxide and water in soils, *Tellus*, 50, 163–178, 1998.
- Trumbore, S.: Age of soil organic matter and soil respiration: radiocarbon constraints on belowground C dynamics, *Ecol. Appl.*, 10, 399–411, 2000.
- Yakir, D. and Sternberg, L. D.: The use of stable isotopes to study ecosystem gas exchange, *Oecologia*, 123, 297–311, 2000.
- Yakir, D. and Wang, X. F.: Fluxes of CO_2 and water between terrestrial vegetation and the atmosphere estimated from isotope measurements, *Nature*, 380, 515–517, 1996.