



**HAL**  
open science

## Near-UV photolysis cross sections of CH<sub>3</sub>OOH and HOCH<sub>2</sub>OOH determined via action spectroscopy

C. M. Roehl, Z. Marka, J. L. Fry, P. O. Wennberg

► **To cite this version:**

C. M. Roehl, Z. Marka, J. L. Fry, P. O. Wennberg. Near-UV photolysis cross sections of CH<sub>3</sub>OOH and HOCH<sub>2</sub>OOH determined via action spectroscopy. *Atmospheric Chemistry and Physics*, 2007, 7 (3), pp.713-720. hal-00296144

**HAL Id: hal-00296144**

**<https://hal.science/hal-00296144>**

Submitted on 18 Jun 2008

**HAL** is a multi-disciplinary open access archive for the deposit and dissemination of scientific research documents, whether they are published or not. The documents may come from teaching and research institutions in France or abroad, or from public or private research centers.

L'archive ouverte pluridisciplinaire **HAL**, est destinée au dépôt et à la diffusion de documents scientifiques de niveau recherche, publiés ou non, émanant des établissements d'enseignement et de recherche français ou étrangers, des laboratoires publics ou privés.

# Near-UV photolysis cross sections of $\text{CH}_3\text{OOH}$ and $\text{HOCH}_2\text{OOH}$ determined via action spectroscopy

C. M. Roehl<sup>1</sup>, Z. Marka<sup>1,\*</sup>, J. L. Fry<sup>2,\*\*</sup>, and P. O. Wennberg<sup>1,3</sup>

<sup>1</sup>Division of Geological and Planetary Sciences, California Institute of Technology, Pasadena, CA 91125, USA

<sup>2</sup>Arthur Amos Noyes Laboratory of Chemical Physics, California Institute of Technology, Pasadena, CA 91125, USA

<sup>3</sup>Division of Engineering and Applied Science, California Institute of Technology, Pasadena, CA 91125, USA

\* now at: Columbia Astrophysics Laboratory, Columbia University, New York, NY 10027, USA

\*\* now at: Department of Chemistry, University of California, Berkeley, Berkeley, CA 94720-1460, USA

Received: 18 October 2006 – Published in Atmos. Chem. Phys. Discuss.: 20 November 2006

Revised: 8 February 2007 – Accepted: 9 February 2007 – Published: 14 February 2007

**Abstract.** Knowledge of molecular photolysis cross sections is important for determining atmospheric lifetimes and fates of many species. A method and laser apparatus for measurement of these cross sections in the near-ultraviolet (UV) region is described. The technique is based on action spectroscopy, where the yield of a photodissociation product (in this case OH) is measured as a function of excitation energy. For compounds yielding OH, this method can be used to measure near-UV photodissociation cross section as low as  $10^{-23}$  cm<sup>2</sup> molecule<sup>-1</sup>. The method is applied to determine the photodissociation cross sections for methyl hydroperoxide ( $\text{CH}_3\text{OOH}$ ; MHP) and hydroxymethyl hydroperoxide ( $\text{HOCH}_2\text{OOH}$ ; HMHP) in the 305–365 nm wavelength range. The measured cross sections are in good agreement with previous measurements of absorption cross sections.

## 1 Introduction

Photolysis rates in the troposphere are determined by the magnitude of the absorption cross sections at wavelengths longer than 305 nm, the so-called “ozone cut-off”. For many molecules, however, absorption cross sections have been measured only at shorter wavelengths where the cross sections are much larger and thus easier to quantify. In these studies, light passes through an absorption cell of known path length ( $l$ ) and intensity is recorded at specific wavelengths ( $\lambda$ ), both with the cell empty ( $I_o(\lambda)$ ) and after sample has been added ( $I(\lambda)$ ). Pressure measurements ( $N$ , in molecule cm<sup>-3</sup>) are simultaneously taken and the absorption cross sections are determined by application of Beer-Lambert’s law:

$$\sigma_{\text{abs},\lambda} = \ln[I_o(\lambda)/I(\lambda)]/lN \quad (1)$$

Correspondence to: C. M. Roehl  
(coleen@gps.caltech.edu)

Absorption measurements in the near-UV region are complicated by several problems. For many species, cross sections in this region are very small (on the order of  $10^{-23}$  cm<sup>2</sup> molecule<sup>-1</sup> or less) but nevertheless contribute significantly to the atmospheric photodissociation rate. To measure these weak molecular absorbances, their contribution often must be separated from larger absorbance caused by impurities that are inevitably present in the sample analyzed. In many cases, the absorption of both the target molecule and the impurities are spectrally unstructured, making the separation difficult. In addition to these problems, determination of the atmospherically relevant quantity, the photodissociation cross section ( $\sigma_{\text{diss},\lambda}$ ), requires the separate measurement of the photodissociation quantum yield,  $\phi_\lambda$ :

$$\sigma_{\text{diss},\lambda} = \sigma_{\text{abs},\lambda} \times \phi_\lambda \quad (2)$$

Photodissociation cross sections can be measured directly with a technique known as action spectroscopy. In this method, the molecule of interest is photolyzed and the yield of a photoproduct is monitored. For example, OH radical may be monitored via laser induced fluorescence (LIF). This detection scheme is especially advantageous since the OH product concentration is monitored against virtually zero background. By scanning the wavelength of the photolysis light source, the action spectrum (photodissociation cross section vs. wavelength) can be obtained. In cases where the photodissociation quantum yield is unity,  $\sigma_{\text{diss},\lambda} = \sigma_{\text{abs},\lambda}$ , action spectroscopy can be used to directly measure absorption cross sections.

An example that demonstrates the advantages of action spectroscopy over typical absorption measurements is the measurement of the cross section of HOBr above 400 nm. Standard absorption measurements are complicated by interferences from impurities introduced in the generation of HOBr (Orlando and Burkholder, 1995). Using action spectroscopy and OH LIF detection, however, Barnes et

al. (1996) discovered a new absorption band around 440 nm arising from excitation to a triplet state that can dominate the atmospheric photodissociation of this molecule in the troposphere and lower stratosphere.

The aim of this study was to develop an accurate photodissociation cross section measurement methodology in the near-UV region based on action spectroscopy. In this wavelength region, just above the ozone cut-off, the absorption spectra of many molecules of atmospheric importance have sizable “tails” which determine their photolysis lifetimes in the atmosphere.

We chose methyl- and hydroxymethyl- hydroperoxide as test molecules for this technique. Accurate near-UV absorption cross sections are required as photodissociation of these molecules is known to be important for determining OH concentrations. Such data is also useful in laboratory studies, where concentrations of these species are often measured by UV absorption. Yet, despite their importance, large uncertainties remain in the literature on these cross sections.

Methyl- and hydroxymethyl- hydroperoxide are the two most abundant atmospheric organic peroxides and act as sinks and temporary reservoirs for both HO<sub>x</sub> and RO<sub>x</sub> species. The transport of these species can have important regional and even global effects on radical concentrations (Jaegle et al., 1997). Peroxides are removed from the atmosphere by wet and dry deposition as well as by reaction with OH radicals or by photolysis:



Hence atmospheric lifetimes, which are determined in part by these processes, will determine the role of these species in the transport of urban photochemistry to remote environments.

## 2 Experimental methodology

We observed the LIF signal from OH following the photolysis of the hydroperoxides in the 305–365 nm wavelength range. The measured OH LIF signal can be expressed as:

$$\text{LIF}(\lambda) = c(\lambda)\phi(\lambda)\sigma(\lambda)[\text{ROOH}], \quad (3)$$

where  $\sigma$  and  $\phi$  describe the wavelength dependent absorption cross section and quantum yield, respectively, [ROOH] is the concentration of the given molecule, and  $c(\lambda)$  is a wavelength dependent but species independent constant related to photon flux and pump-probe laser overlap volume.

The measured signals of MHP were converted to absolute cross sections using a reference species, hydrogen peroxide (or H<sub>2</sub>O<sub>2</sub>), which has a well-known absorption cross section in this wavelength region (Nicovich and Wine, 1988). The photolysis quantum yield for H<sub>2</sub>O<sub>2</sub> has been previously measured at 248 nm, where it dissociates to two OH radicals

( $\phi=2$ ) (Vaghjiani and Ravishankara, 1990). At longer wavelengths, such as in our studies, the OH quantum yield is also accepted to be 2 (Sander et al., 2006). Substituting the known cross sections for H<sub>2</sub>O<sub>2</sub> ( $\sigma_{\text{HOOH}}$ ) and  $\phi_{\text{HOOH}}=2$ , the ratio of the laser-power-normalized LIF counts,

$$\frac{\text{LIF}_{\text{peroxide}}}{\text{LIF}_{\text{HOOH}}} = \frac{\phi_{\text{peroxide}}\sigma_{\text{peroxide}}[\text{peroxide}]}{\phi_{\text{HOOH}}\sigma_{\text{HOOH}}[\text{HOOH}]}, \quad (4)$$

is used to obtain the photolysis cross sections ( $\phi \times \sigma$ ). By employing this ratio equation at every wavelength measured, the  $c(\lambda)$  constants cancel out of the equation making their difficult determination unnecessary. All peroxide concentrations were determined using FTIR spectroscopy.

The signals for MHP and H<sub>2</sub>O<sub>2</sub> were measured back-to-back at each wavelength. For HMHP, however, the system required longer times to condition the walls, making switching between HMHP and H<sub>2</sub>O<sub>2</sub> at each wavelength impractical. Instead, continuous HMHP spectra were obtained by scanning the photolysis laser from 312 to 357 nm. These spectra were normalized for laser power, small changes in the concentration of HMHP and H<sub>2</sub>O<sub>2</sub> impurity (both as determined by FTIR), and changes in photon flux. Similar scans were performed for H<sub>2</sub>O<sub>2</sub> before and after each HMHP scan. To account for any changes in the pump-probe laser overlap volume, our measured H<sub>2</sub>O<sub>2</sub> cross sections were compared to the “accepted” H<sub>2</sub>O<sub>2</sub> cross sections generated from the parameterization of Nicovich and Wine (1988). A wavelength dependent correction was calculated and applied to our measured HMHP cross sectional values.

Absolute HMHP cross sections were referenced to the  $\sigma_{\text{HMHP}}$  value of Bauerle and Moortgat (1999) at 320 nm ( $1.3 \times 10^{-21} \text{ cm}^2 \text{ molecule}^{-1}$ ).

Equation (3) holds true only if experiments are conducted under optically thin conditions and the OH LIF signal is taken just after the photolysis laser pulse. At longer times, the temporal profile of OH concentration decays, with a rate constant of  $k = k_d + \sum k_i [i]$ , where  $k_d$  is the rate coefficient for diffusion of OH out of the detection zone and  $k_i$  is the rate coefficient for the bimolecular reaction of OH with species  $i$ . If the total pressure and flow rates in the sample cell are the same,  $k_d$  will not be different for the target and reference gas. Under the same experimental flow and pressure conditions, however, differences in the OH temporal profiles can arise from differing bimolecular rate constants of OH with the target and reference compounds. With fast electronics and high sensitivity (and thus limited concentrations of the peroxides), it is possible to limit the observational period to be sufficiently short that correction for the different OH loss in the flow tube is not required.

## 3 Instrumentation

Figure 1 depicts the laser system and the gas delivery scheme used in our experiments. A system of two lasers, with variable time delay, is used to produce the photolysis pump pulse

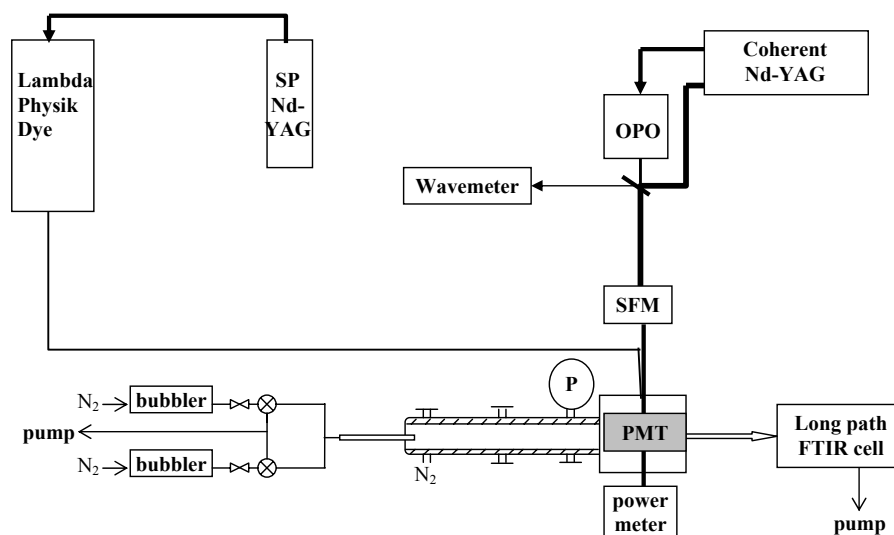

**Fig. 1.** Experimental setup for photolysis cross section measurements in the near-UV region. (OPO – optical parametric oscillator; SFM – sum frequency mixing.)

(near-UV) and the OH LIF probe (282 nm). LIF signal is recorded using a photomultiplier tube operated in single photon counting mode. The gas mixtures are carried through a glass flow tube and detection block before transiting through a long pass FTIR cell for concentration determination.

### 3.1 Gas delivery, reaction chamber and FTIR cell

Gas-phase peroxides were generated by passing N<sub>2</sub> through a bubbler containing the organic peroxide or H<sub>2</sub>O<sub>2</sub>. Semiconductor grade H<sub>2</sub>O<sub>2</sub> was obtained commercially (FMC Corporation) at 70% in H<sub>2</sub>O, and used as purchased. MHP was synthesized via a literature procedure (Vaghjiani and Ravishankara, 1989b). Synthesis of HMHP is based on the method described by Bauerle and Moortgat (1999). A low flow of N<sub>2</sub> is passed over 5 g paraformaldehyde powder (Aldrich) at 100°C and subsequently bubbled for ~14 hours through 7 mL 90–95% H<sub>2</sub>O<sub>2</sub> (distilled from 70%) in H<sub>2</sub>O maintained at 60°C. Excess H<sub>2</sub>O<sub>2</sub> was maintained during the synthesis to avoid formation of *bis*-HMHP (HOCH<sub>2</sub>OOCH<sub>2</sub>OH). The resulting liquid sample is immediately placed in a glass bubbler for the experiments. To prevent injury in case of a peroxide explosion, the HMHP bubbler is housed in a Plexiglas box. Although efforts were made to consistently synthesize HMHP with the smallest amount of impurities, the presence of H<sub>2</sub>O<sub>2</sub> impurity in our HMHP samples is seemingly unavoidable. Therefore, the sample is pumped on at highest possible pumping speed for several hours prior to photolysis experiments to remove remaining H<sub>2</sub>O, HCOOH, and H<sub>2</sub>O<sub>2</sub> contamination. The MHP and HMHP purities were checked by FTIR measurements.

A bulb of water behind a valve is connected to the top of the HMHP bubbler and outside of the sample box. After

each experiment is finished, the peroxide residue is quenched with water prior to any handling. *Extreme caution should be exercised when working with concentrated samples of peroxides. The water quenching method is highly recommended; this was implemented after an explosion occurred when our seemingly empty sample vessel containing HMHP residue was vented to atmospheric pressure.*

The bubblers containing MHP and H<sub>2</sub>O<sub>2</sub> were kept in ice water, while the HMHP bubbler was maintained at room temperature. In order to establish stable peroxide flows and constant pressures over the peroxides in the bubblers (~400 Torr for MHP, ~200 Torr for H<sub>2</sub>O<sub>2</sub>) over the timeframe of each measurement, mass flow controllers were used to set the N<sub>2</sub> flow over the bubbler (80 sccm for both MHP and H<sub>2</sub>O<sub>2</sub> and 30 sccm for HMHP) and glass frits were used downstream of the bubblers. The MHP and H<sub>2</sub>O<sub>2</sub> peroxide vapors then were mixed with an additional 200 sccm of N<sub>2</sub> upon entering a jacketed glass flow cell (50 cm long, 2.5 cm internal diameter, Teflon coated to minimize heterogeneous chemistry on the walls). Due to the rapid decomposition of HMHP on the walls, it was necessary to reduce the pressure of HMHP in the bubbler (to ~30 Torr) and increase the flow rates in the inlet region. No N<sub>2</sub> gas was introduced. The peroxide flow entered the reaction chamber where it crossed the pump and probe laser beams. The output port of the reaction chamber led to an 86 cm long double pass FTIR cell, an external cell connected to a Nicolet Magna-IR 560 FTIR interferometer. The flow tube, reaction chamber, and FTIR cell pressures were maintained around 30 Torr for MHP and H<sub>2</sub>O<sub>2</sub>; signal optimization occurred at ~3 Torr for the HMHP system. H<sub>2</sub>O<sub>2</sub> concentration was determined by fitting the obtained IR spectra with the H<sub>2</sub>O<sub>2</sub> cross sections from the HITRAN database (Rothman et al., 2003).

The MHP concentration was determined from an absorption feature in the C-H stretch region at 2963.8 cm<sup>-1</sup>, using a published absorption coefficient ( $\epsilon$ ) of 3.2 × 10<sup>-19</sup> cm<sup>2</sup> molecule<sup>-1</sup> which was obtained at 0.0625 cm<sup>-1</sup> theoretical resolution (Niki et al., 1983). The MHP concentrations used here were typically (1–10) × 10<sup>14</sup> molecule cm<sup>-3</sup>. The HMHP concentration was determined from a peak in the C-O stretch region at 1049 cm<sup>-1</sup>. A peak IR absorption coefficient ( $\epsilon$ ) of 3 × 10<sup>-19</sup> cm<sup>2</sup> molecule<sup>-1</sup> was averaged from two literature values and employed here (Neeb et al., 1997; Bauerle and Moortgat, 1999). Typical concentrations of HMHP were (1–3) × 10<sup>14</sup> molecule cm<sup>-3</sup> with H<sub>2</sub>O<sub>2</sub> impurities of (2–20) × 10<sup>12</sup> molecule cm<sup>-3</sup>. The concentration of the reference H<sub>2</sub>O<sub>2</sub> was (2–12) × 10<sup>14</sup> molecule cm<sup>-3</sup>.

### 3.2 Lasers and detection

The photolysis laser light was generated by sum frequency mixing the signal output of a Type-II BBO optical parametric oscillator (OPO) with the 1064 nm fundamental output of a pulsed Nd:YAG laser (Coherent Infinity 40–100). The 355 nm THG (third harmonic generation) output of the same Nd:YAG laser serves as the pump for the OPO (Wu et al., 1997). The frequency of the signal output of the OPO was continuously monitored by a pulsed wavemeter (Burleigh), from which the mixed near-UV wavelength is calculated. The OPO signal and Nd:YAG fundamental beams are brought together with a high frequency beam splitter and collinearly enter a Type-I BBO crystal used for generating the near-UV beam. A Pellin-Broca prism spatially separates the various frequencies of light exiting this mixing crystal and also serves as a compensator for the directional beam changes as the mixing crystal is rotated. The mixing crystal and prism are mounted on calibrated and fully automated mechanical drives. For the mixed beam a power of >100 mW (at 100 Hz repetition rate) is easily achieved in the 305–365 nm wavelength range, with pulse length around 10 ns. During experiments, fluctuations in the laser power are continuously monitored by a photodiode, which is aligned in the path of the reflected portion of the UV beam from the CaF<sub>2</sub> Brewster angle input window of the detection cell. The photodiode signal is calibrated against a thermal power meter positioned at the optical exit (also a CaF<sub>2</sub> Brewster angle window). Photodissociation occurs via the lowest energy channel in MHP:

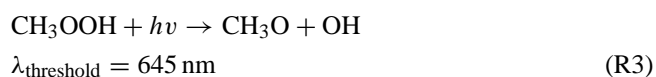

Similarly, photolysis of HMHP is expected to proceed via:

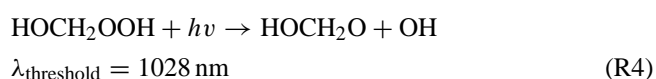

The OH probe laser system consists of a frequency doubled Nd:YAG laser (Spectra Physics), which serves as the pump

of a Rhodamine 6G dye laser (Lambda Physik). The Q-switch of the Nd:YAG laser is slaved with a variable delay to the photodissociation laser. In this work, the LIF data for the cross section measurements were taken 1 μs following the photodissociation pulse with a gate window of a 30 ns. The second harmonic UV output from this system (<1 μJ pulse energy, ~40 ns pulse width, tunable around 282 nm) excites the OH generated in the photolysis chamber. For the data reported here, the UV probe beam is tuned to the strongest OH LIF feature (Q<sub>11</sub>(1)+Q<sub>21</sub>(1)+R<sub>22</sub>(3) unresolved triplet of lines) in the A<sup>2</sup>Σ(v'=1) ← X<sup>2</sup>Π(v''=0) band. The photolytic production of excited OH (v''>0) is expected to be small and is assumed negligible here (Ondrey et al., 1983). Following collisional energy transfer, the excited OH molecules are quenched to the ground vibrational state of the excited electronic state (v'=0). Fluorescence is observed near 309 nm from many rotational states (A<sup>2</sup>Σ(v'=0) → X<sup>2</sup>Π(v''=0)) (Wennberg et al., 1994). The LIF signal is focused onto a bi-alkali photomultiplier tube mounted above the detection region, at right angles to both the laser beams and the gas flow. A narrow-band interference filter centered at 310 nm is employed to reject scattered UV laser light. The pump and probe beams are spatially overlapped before crossing the flowing gas in the interaction volume.

A PC controls a National Instruments DA/AD board for digitizing the laser power measurements, and an SRS400 gated counter collects the LIF signal input from the photomultiplier tube.

## 4 Results and discussion

Our experiments were aimed at directly determining the photolysis cross section of MHP and HMHP in the atmospherically important near-UV region. The quantum yield of OH in the atmospheric photolysis of both species is generally accepted to be unity, e.g., Vaghjiani and Ravishankara (1990) at 248 nm for MHP. Thus, the near-UV photodissociation cross section from this experiment can be compared to previous absorption cross section measurements.

By varying the delay between the near-UV photolysis and the LIF probe laser pulses, we recorded the temporal profile of the OH photolysis product. Under our experimental flow conditions and concentrations, the OH lifetime in the detection region at 30 Torr is around 0.2 ms. Most of this decay is due to flow and diffusion of OH products from the detection zone as well as bimolecular reaction of OH with the peroxides. Though the difference between the corresponding reaction rate constants is substantial (1.7 × 10<sup>-12</sup> cm<sup>3</sup> molecule<sup>-1</sup> s<sup>-1</sup> for (OH+H<sub>2</sub>O<sub>2</sub>) vs. 5.5 × 10<sup>-12</sup> cm<sup>3</sup> molecule<sup>-1</sup> s<sup>-1</sup> for (OH+CH<sub>3</sub>OOH) Vaghjiani and Ravishankara, 1989b) for the concentrations used in our experiments this contributes minimal differences in the observed OH lifetime. (The rate constant for the

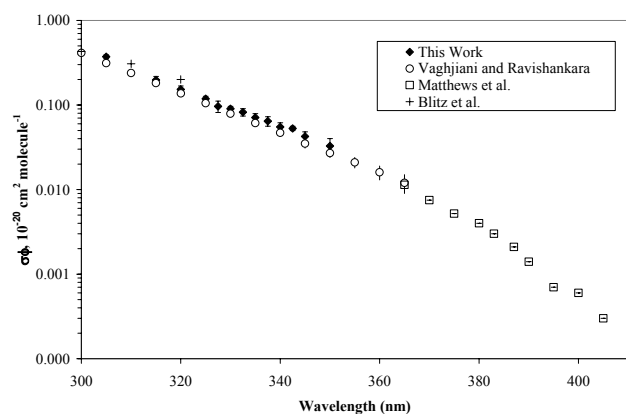

**Fig. 2a.** Measured photolysis cross sections of methyl hydroperoxide (solid diamonds) compared with absorption cross sections of Vaghjiani and Ravishankara (1989a) (open circles), with longer wavelength measurements by Matthews et al. (2005) (open squares), and with shorter wavelength measurements by Blitz et al. (plus signs).

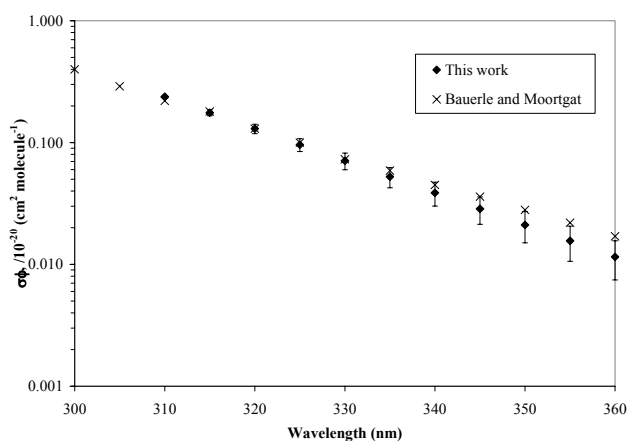

**Fig. 2b.** Measured photolysis cross sections of hydroxymethyl hydroperoxide (solid diamonds) compared with values from Bauerle and Moortgat (1999) (crosses).

OH+HOCH<sub>2</sub>OOH reaction has not been measured, but is assumed to be comparable.)

The UV photolysis cross sections for MHP and HMHP as a function of wavelength are shown in Fig. 2, with tabulated results given in Tables 1 and 2. Our MHP work is compared to UV cross sections reported by Blitz et al. (2005) for wavelengths  $\leq 320$  nm, by Vaghjiani and Ravishankara (1989a) in the range between 300 and 365 nm, and recently by Matthews et al. (2005) between 355 and 405 nm. Our HMHP data is compared with the values of Bauerle and Moortgat (1999) 300–360 nm.

The error bars in Fig. 2 represent the standard deviation from several measurements (3–10) at the same wavelength. Using  $\phi=1$ , the measured absorption cross section values for MHP are 8–21% greater, but still within the error limits, of results from Vaghjiani and Ravishankara (1989a), which are also the current recommended JPL (Sander et al., 2006) values. The Blitz et al. data is consistently larger than values of Vaghjiani and Ravishankara between 300 to 320 nm and is 31% higher than our one overlapping data point at 320 nm. The authors do not report cross section values above 320 nm due to a difficulty in positioning their absorption cell precisely between background and sample runs and it appears that their data between 300 and 320 nm is also erroneously high. Our data shown in Fig. 2a and Table 1 were obtained by taking reference measurements to hydrogen peroxide photolysis cross sections. Recent reevaluation of earlier hydrogen peroxide cross section measurement in the near-UV by Knight et al. (2002) resolved previous discrepancies in the H<sub>2</sub>O<sub>2</sub> absorption cross section data around 340 nm. Thus the cross section values of Knight and coworkers in agreement with Molina and Molina (1981) as well as with the parameterization of Nicovich and Wine (1988) were used as reference for hydrogen peroxide near-UV absorption cross section, with a photolysis quantum yield of 2.

Our reported and Bauerle and Moortgat's literature HMHP data is given in Fig. 2b and Table 2. Reasonable agreement (within  $\sim 20\%$ ) is observed between 310 and 340 nm, however, our HMHP cross section values remain lower than literature values, with a measured cross section at 350 nm which is 33% lower. (No error limits were reported by Bauerle and Moortgat.) The discrepancy in the data might be due to the contribution of impurities in the data of Bauerle and Moortgat. However, it is also possible that there is an error in the H<sub>2</sub>O<sub>2</sub> parameterization used, some unaccounted systematic change in error in  $c(\lambda)$ , or some combination of these errors.

A significant source of uncertainty in our absolute photolysis cross section values results from uncertainties in the infrared extinction coefficients used. For MHP, the literature value was obtained with an FTIR instrument at a resolution of  $0.0625\text{ cm}^{-1}$ . Our on-line FTIR used  $0.25\text{ cm}^{-1}$  resolution. The differences in FTIR absorption of MHP at  $2963.8\text{ cm}^{-1}$  at  $0.0625$  and  $0.25\text{ cm}^{-1}$  (16% at  $\sim 30$  Torr) was determined from spectra obtained at high resolution using a Bruker (IFS 125HR) spectrometer and a correction factor was applied. A similar correction was not necessary in the case of HMHP as no resolution effect was observed between the resolutions of  $0.5\text{ cm}^{-1}$  (used to obtain the referenced literature value) and  $1.0\text{ cm}^{-1}$  (used in this study).

**Table 1.** Absorption cross sections as a function of wavelength for methyl hydroperoxide. Extrapolated cross sections are indicated by an asterisk (\*). † Note: The Matthews et al. data are normalized to the 355 nm cross section value measured by Vaghjiani and Ravishankara.

Wavelength (nm)	Cross section (cm <sup>2</sup> molecule <sup>-1</sup> )			
	This work	Vaghjiani and Ravishankara (1989a)	Matthews et al. (2005)	Blitz et al. (2005)
300		(4.13±0.15)E-21		4.29E-21
305	(3.72±0.19)E-21	(3.13±0.11)E-21		
310		(2.39±0.09)E-21		3.07E-21
315	(1.98±0.20)E-21	(1.82±0.07)E-21		
320	(1.53±0.15)E-21	(1.37±0.06)E-21		2.00E-21
325	(1.19±0.08)E-21	(1.05±0.05)E-21		
330	(9.00±0.60)E-22	(7.90±0.40)E-22		
335	(7.10±0.80)E-22	(6.10±0.40)E-22		
340	(5.50±0.70)E-22	(4.70±0.40)E-22		
345	(4.30±0.60)E-22	(3.50±0.40)E-22		
350	(3.30±0.70)E-22	(2.70±0.30)E-22		
355	2.49E-22*	(2.10±0.30)E-22	2.10E-22†	
360		(1.60±0.30)E-22		
365		(1.20±0.30)E-22	(1.14±0.05)E-22	
370			(7.50±0.50)E-23	
375			(5.20±0.50)E-23	
380			(4.00±0.60)E-23	
385				
390			(1.40±0.60)E-23	
395			(7.00±50)E-24	
400			(6.00±5.0)E-24	

**Table 2.** Absorption cross sections as a function of wavelength for hydroxymethyl hydroperoxide. † This work is normalized to the 320 nm cross section value measured by Bauerle and Moortgat.

Wavelength (nm)	Cross section (cm <sup>2</sup> molecule <sup>-1</sup> )	
	HMHP this work	Bauerle and Moortgat (1999)
300		4.00E-21
305		2.90E-21
310	(2.38±0.05)E-21	2.20E-21
315	(1.76±0.10)E-21	1.80E-21
320	(1.30±0.12)E-21†	1.30E-21
325	(9.60±1.17)E-22	1.00E-21
330	(7.09±1.10)E-22	7.30E-22
335	(5.24±0.99)E-22	5.90E-22
340	(3.87±0.86)E-22	4.50E-22
345	(2.86±0.73)E-22	3.60E-22
350	(2.11±0.61)E-22	2.80E-22
355	(1.56±0.50)E-22	2.20E-22
360	(1.15±0.41)E-22	1.70E-22

Figure 3 shows the experimentally obtained ratio of photolysis cross section of hydrogen peroxide and methyl hydroperoxide up to 365 nm. An independent measurement of absorption cross section above 350 nm is not available for H<sub>2</sub>O<sub>2</sub>. As the wavelength increases above 350 nm, the

H<sub>2</sub>O<sub>2</sub>/MHP cross section ratio decreases below 2, indicating that MHP more efficiently dissociates at higher wavelengths than hydrogen peroxide. Some additional data was taken at decreased temperatures (260 K) in the high wavelength tail. Above 350 nm H<sub>2</sub>O<sub>2</sub>/MHP cross section ratio increased sig-

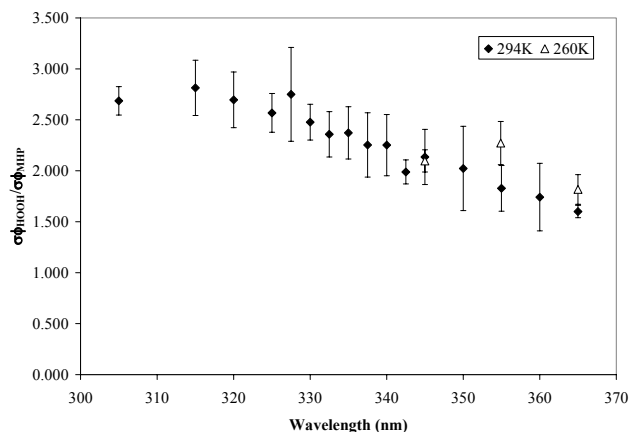

**Fig. 3.** Ratio of hydrogen peroxide and methyl hydroperoxide photolysis cross sections versus wavelength (solid diamonds taken at 294 K; open triangles at 260 K).

nificantly at lower temperatures hinting at possible reduced MHP photodissociation at colder temperatures that needs to be studied further.

Taking advantage of the wide wavelength range of our laser system we also searched for peroxide absorption features in the 430–550 nm wavelength region, by removing the frequency mixing stage and using the signal output of the OPO. As expected, no LIF signal was detected for either MHP or HMHP. This finding is consistent with unpublished electronic excited state calculations of HMHP (Lane, J., private communication).

In order to evaluate the atmospheric importance of UV photolysis, the ground-level total UV photolysis rates across the 300–400 nm window (between the ozone cutoff and where the cross sections become small and hence atmospherically negligible) were determined for MHP and HMHP data collected here as well as literature data. By using the log-linear dependence of the absorption cross section versus wavelength observed for many molecules (Sander et al., 2006), cross sections were extrapolated out to 400 nm. Cross sections were then multiplied by solar actinic fluxes calculated at the Earth's surface (0 km and 40° zenith angle) for each wavelength (Finlayson-Pitts and Pitts, 1986) to get the partial photolysis rates  $J_\lambda$ :

$$J_\lambda = \sigma(\lambda)I(\lambda)d\lambda[\text{s}^{-1}\text{nm}^{-1}] \quad (5)$$

These partial photolysis rates  $J_\lambda$  as a function of wavelength are compared in Fig. 4. Note that the photolysis rates for both species are dominated by absorption occurring near 330 nm. A coarse box integration of the band is then calculated by summing all these partial photolysis rates, to derive the total photolysis rate  $J$ :

$$J = \sum_{\lambda} J_\lambda[\text{s}^{-1}] \quad (6)$$

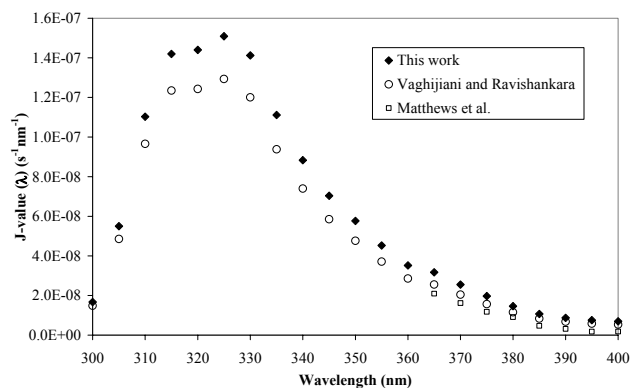

**Fig. 4a.** Partial photolysis rates for methyl hydroperoxide: using measured cross sections plus extrapolated values between 355–400 nm (solid diamonds), using cross sections of Vaghjiani and Ravishankara (1989a) plus extrapolation between 370–400 nm (open circles), and using long wavelength measurements by Matthews et al. (2005) (open squares).

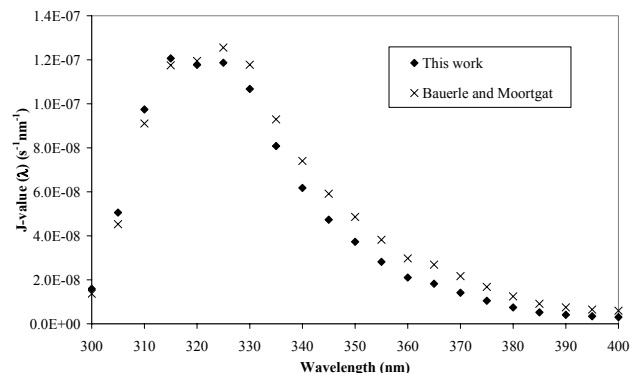

**Fig. 4b.** Partial photolysis rates for hydroxymethyl hydroperoxide: using measured cross sections plus extrapolated values between 365–400 nm (solid diamonds) and using cross sections of Bauerle and Moortgat (1999) plus extrapolation between 365–400 nm (crosses).

The integrated UV photolysis in the region 300–400 nm is likely to account for most of the UV photolysis of these peroxides.

Integrating, the calculated total photolysis rates for MHP are  $1.3 \times 10^{-6} \text{ s}^{-1}$  and  $1.1 \times 10^{-6} \text{ s}^{-1}$ , using the cross sections (plus extrapolations) determined by this work and that of Vaghjiani and Ravishankara (1989a), respectively, suggesting that the cross sections reported here will produce an increase of ~20% in the total UV photolytic loss over previous estimates. This increase is reduced to 10% if the long wavelength ( $\lambda > 360 \text{ nm}$ ) cross sections of Matthews et al. (2005) are substituted into the summations instead of the extrapolated values. Matthews et al. use a similar OH LIF technique and compare back-to-back OH yields at desired photolysis wavelengths with that from a 355 nm reference



beam. Using the 355 nm cross section value measured by Vaghjiani and Ravishankara and normalizing for laser power gives them an estimate of the absorptions cross sections at the longer wavelengths. Similar calculations for HMHP resulted in photolysis rates of  $9.7 \times 10^{-7} \text{ s}^{-1}$  and  $1.1 \times 10^{-6} \text{ s}^{-1}$ , using the cross sections determined by this work and that of Bauerle and Moortgat (1999), respectively. This suggests a decrease in the total UV photolytic loss for HMHP from 300–400 nm of  $\sim 10\%$ . For both HMHP and HMP, the calculations shown in Figs. 4a and b are meant to be simply illustrative – the photolysis rates used in atmospheric modeling will be calculated from the measured or calculated actinic flux and the measured cross sections. Because our determination of the cross sections (and those of Vaghjiani and Ravishankara, 1989a and Bauerle and Moortgat, 1999) are dominated by systematic error, we recommend averaging the respective MHP and HMHP data sets listed in Tables 1 and 2.

*Acknowledgements.* The authors thank the National Science Foundation (ATM-0432377) and the Massachusetts Institute of Technology, Air Quality Models Project (R824970-01-0) for support of this research.

Edited by: J. N. Crowley

## References

- Barnes, R. J., Lock, M., Coleman, J., and Sinha, A.: Observation of a new absorption band of HOBr and its atmospheric implications, *J. Phys. Chem.* 100, 453–457, 1996.
- Bauerle, S. and Moortgat, G. K.: Absorption cross-sections of HOCH<sub>2</sub>OOH vapor between 205 and 360 nm at 298 K, *Chem. Phys. Lett.*, 309, 43–48, 1999.
- Finlayson-Pitts, B. J. and Pitts Jr., J. N.: *Atmospheric Chemistry: Fundamentals and Experimental Techniques*, Wiley, New York, 1986.
- Jaegle, L., Webster, C. R., May, R. D., Scott, D. C., Stimpfle, R. M., Kohn, D. W., Wennberg, P. O., Hanisco, T. F., Cohen, R. C., Proffitt, M. H., Kelly, K. K., Elkins, J., Baumgardner, D., Dye, J. E., Wilson, J. C., Poeschel, R. F., Chan, K. R., Salawitch, R. J., Tuck, A. F., Hovde, S. J., and Yung, Y. L.: Evolution and stoichiometry of heterogeneous processing in the Antarctic stratosphere, *J. Geophys. Res. – Atmos.*, 102, 13 235–13 253, 1997.
- Knight, G., Ravishankara, A. R., and Burkholder, J. B.: UV absorption cross sections of HO<sub>2</sub>NO<sub>2</sub> between 343 and 273 K, *Phys. Chem. Chem. Phys.*, 4, 1432–1437, 2002.
- Matthews, J., Sinha, A., and Francisco, J. S.: The importance of weak absorption features in promoting tropospheric radical production, *Proceedings of the National Academy of Sciences of the USA*, 102, 7449–7452, 2005.
- Molina, L. T. and Molina, M. J.: UV absorption cross-sections of HO<sub>2</sub>NO<sub>2</sub> vapor, *J. Photochem.*, 15, 97–108, 1981.
- Neeb, P., Sauer, F., Horie, O., and Moortgat, G. K.: Formation of hydroxymethyl hydroperoxide and formic acid in alkene ozonolysis in the presence of water vapour, *Atmos. Environ.*, 31, 1417–1423, 1997.
- Nicovich, J. M. and Wine, P. H.: Temperature-dependent absorption cross-sections for hydrogen-peroxide vapor, *J. Geophys. Res.*, 93, 2417–2421, 1988.
- Niki, H., Maker, P. D., Savage, C. M., and Breitenbach, L. P.: A Fourier-transform infrared study of the kinetics and mechanism for the reaction HO+CH<sub>3</sub>OOH, *J. Phys. Chem.*, 87, 2190–2193, 1983.
- Ondrey, G., van Veen, N., and Bersohn, R.: The state distribution of OH radicals photodissociated from H<sub>2</sub>O<sub>2</sub> at 193 and 248 nm, *J. Chem. Phys.*, 78(6), 3732–3737, 1983.
- Orlando, J. J. and Burkholder, J. B.: Gas-phase UV visible absorption-spectra of HOBr and Br<sub>2</sub>O, *J. Phys. Chem.*, 99, 1143–1150, 1995.
- Rothman, L. S., Barbe, A., Benner, D. C., Brown, L. R., Camy-Peyret, C., Carleer, M. R., Chance, K., Clerbaux, C., Dana, V., Devi, V. M., Fayt, A., Flaud, J. M., Gamache, R. R., Goldman, A., Jacquemart, D., Jucks, K. W., Lafferty, W. J., Mandin, J. Y., Massie, S. T., Nemtchinov, V., Newnham, D. A., Perrin, A., Rinsland, C. P., Schroeder, J., Smith, K. M., Smith, M. A. H., Tang, K., Toth, R. A., Vander Auwera, J., Varanasi, P., and Yoshino, K.: *The HITRAN molecular spectroscopic database: edition of 2000 including updates through 2001*, *J. Quant. Spect. & Rad. Trans.*, 82, 5–44, 2003.
- Sander, S. P., Friedl, R. R., Golden, D. M., Kurylo, M. J., Moortgat, G. K., Wine, P. H., Ravishankara, A. R., Kolb, C. E., Molina, M. J., Finlayson-Pitts, B. J., Huie, R. E., and Orkin, V. L.: *Chemical Kinetics and Photochemical Data for Use in Atmospheric Studies*, Eval. 15, National Aeronautics and Space Administration, Jet Propulsion Laboratory, and California Institute of Technology, Pasadena, CA, 2006.
- Vaghjiani, G. L. and Ravishankara, A. R.: Absorption cross-sections of CH<sub>3</sub>OOH, H<sub>2</sub>O<sub>2</sub>, and D<sub>2</sub>O<sub>2</sub> vapors between 210 nm and 365 nm at 297 K, *J. Geophys. Res.*, 94, 3487–3492, 1989a.
- Vaghjiani, G. L. and Ravishankara, A. R.: Kinetics and mechanism of OH reaction with CH<sub>3</sub>OOH, *J. Phys. Chem.*, 93, 1948–1959, 1989b.
- Vaghjiani, G. L. and Ravishankara, A. R.: Photodissociation of H<sub>2</sub>O<sub>2</sub> and CH<sub>3</sub>OOH at 248 nm and 298 K: Quantum yields for OH, O(<sup>3</sup>P) and H(<sup>2</sup>S), *J. Chem. Phys.*, 92, 996–1003, 1990.
- Wennberg, P. O., Cohen, R. C., Hazen, N. L., Lapson, L. B., Allen, N. T., Hanisco, T. F., Oliver, J. F., Lanham, N. W., Demusz, J. N., and Anderson, J. G.: Aircraft-borne, laser-induced fluorescence instrument for the in-situ detection of hydroxyl and hydroperoxyl radicals, *Rev. Sci. Instrum.*, 65, 1858–1876, 1994.
- Wu, S., Blake, G. A., Sun, Z. Y., and Ling, J. W.: Simple, high-performance type II beta-BaB<sub>2</sub>O<sub>4</sub> optical parametric oscillator, *Appl. Opt.*, 36, 5898–5901, 1997.