



HAL
open science

Microcantilever-based Weather Station for Temperature, Humidity And Wind Velocity Measurement

Chia-Yen Lee, R.-H. Ma, Y.-H. Wang, P.-Ch. Chou, L.-M. Fu

► **To cite this version:**

Chia-Yen Lee, R.-H. Ma, Y.-H. Wang, P.-Ch. Chou, L.-M. Fu. Microcantilever-based Weather Station for Temperature, Humidity And Wind Velocity Measurement. DTIP 2007, Apr 2007, Stresa, lago Maggiore, Italy. pp.69-73. hal-00257664

HAL Id: hal-00257664

<https://hal.science/hal-00257664>

Submitted on 20 Feb 2008

HAL is a multi-disciplinary open access archive for the deposit and dissemination of scientific research documents, whether they are published or not. The documents may come from teaching and research institutions in France or abroad, or from public or private research centers.

L'archive ouverte pluridisciplinaire **HAL**, est destinée au dépôt et à la diffusion de documents scientifiques de niveau recherche, publiés ou non, émanant des établissements d'enseignement et de recherche français ou étrangers, des laboratoires publics ou privés.

MICROCANTILEVER-BASED WEATHER STATION FOR TEMPERATURE, HUMIDITY AND WIND VELOCITY MEASUREMENT

*Chia-Yen Lee*¹, *Rong-Hua Ma*², *Yu-Hsiang Wang*¹, *Po-Cheng Chou*³, *Lung-Ming Fu*⁴

¹Department of Mechanical and Automation Engineering, Da-Yeh University, Changhua, Taiwan.

²Department of Mechanical Engineering, R.O.C. Military Academy, Kaohsiung, Taiwan.

³Department of Interior Design, Shu-Te University of Science and Technology, Kaohsiung, Taiwan.

⁴Department of Materials Engineering, National Pingtung University of Science and Technology, Pingtung, Taiwan.

ABSTRACT

The current study develops a new process for the fabrication of Pt resistor temperature detectors (RTD), cantilevers covered with a water-absorbent polyimide layer for humidity measurement and bending-up cantilevers to determining the wind velocity. Pt RTD's are fabricated on the silicon substrate. The temperature measurement is based on the linear resistance variations when temperature changes. The polyimide layer is spun on the cantilever to form a humidity sensing layer. A variation in humidity causes moisture-dependent bending of the microcantilever, which changes the measured resistance of the resistor on the microcantilever. The same type of microcantilever without spinning on polyimide is used to form an anemometer. It is found the cantilever slightly bends upward as a result of the released residual stress induced in the beam during the fabrication. When wind passes over the cantilever beam, a small deformation occurs. Variations in the wind velocity can therefore be determined by measuring the changes in resistance caused by the beam deflection using a LCR meter.

1. INTRODUCTION

In the last decade, emerging MEMS technology and micromachining techniques have been popular in the miniaturization of sensors. Importantly, the functionality and reliability of these microsensors can be increased through their integration with mature logic IC technology or with other sensors.

Based on IC fabrication technology, MEMS sensors for monitoring an individual, such pressure, sensors, anemometers, humidity sensors and temperature sensors or multi-functional sensors with two or more weather parameters [1-5] have been reported in previous studies. The proposed microcantilever-based weather station

consists of temperature sensors, humidity sensors and anemometers on the same type of cantilevers integrated in a chip.

Among the weather parameters, temperature was recognized a key factor in determining the accuracy of the measurement. There was less developed device which could provide an adequate temperature compensation mechanism. Chatzandroulis et al. [6] fabricated silicon cantilevers using a dry release process and incorporated them in a capacitive-type humidity sensor. However, the proposed device still lacked an adequate temperature compensation mechanism.

Reference [7] described the use of Pt resistors as reliable temperature sensors in MEMS-based temperature control system. The current study develops a new process for the fabrication of Pt resistor temperature detectors (RTD), cantilevers covered with a water-absorbent polyimide layer for humidity measurement and bending-up cantilevers to determining the wind velocity. Pt RTD's are fabricated on the silicon substrate. The temperature measurement is based on the linear resistance variations when temperature changes. The polyimide layer is spun on the cantilever to form a humidity sensing layer. A variation in humidity causes moisture-dependent bending of the microcantilever, which changes the measured resistance of the resistor on the microcantilever. The same type of microcantilever without spinning on polyimide is used to form an anemometer. It is found the cantilever slightly bends upward as a result of the released residual stress induced in the beam during the fabrication. When wind passes over the cantilever beam, a small deformation occurs. Variations in the wind velocity can therefore be determined by measuring the changes in resistance caused by the beam deflection using a LCR meter.

2. DESIGN

2.1 Cantilever deflection induced by thermal stress

Figure 1(a) shows a schematic illustration of the current bimorph microcantilever and the corresponding geometrical model. In this study, a thin film of silicon nitride is deposited on a silicon beam. In the model shown in Fig. 1, the thicknesses of the film and beam are denoted as t_1 and t_2 , respectively. (Note that hereafter, subscripts 1 and 2 are used to indicate the film and the beam, respectively). The mismatch between the thermal expansion coefficients of the film and beam which arises when the microcantilever is subjected to thermal loading induces different thermal deformations of the two components and this causes residual stresses to be generated within the structure. Figure 1(b) shows a schematic diagram of the deformed microcantilever. The relationship between the microcantilever displacement and the film and beam thicknesses is given approximately by

$$(t_1 + t_2)d\theta = \delta_1 + \delta'_1 - \delta_2, \quad (1)$$

where δ_1 and δ_2 are the displacements of the film and beam caused by thermal expansion. From the geometrical similarity in Fig. 1(b), it can be shown that the relationship among δ_1 , δ_2 , t_1 , and t_2 is given by

$$\frac{\delta_1 - \delta_2}{t_2} = \frac{\delta'_1}{t_1}. \quad (2)$$

Substituting eq. (2) and the relationships $\delta_1 = \alpha_1 \Delta T dx$ and $\delta_2 = \alpha_2 \Delta T dx$ into eq. (1) yields

$$(t_1 + t_2)d\theta = \Delta T (\alpha_1 - \alpha_2) \left(1 + \frac{t_1}{t_2} \right) dx, \quad (3)$$

where ΔT is the temperature rise and α_1 and α_2 are the coefficients of thermal expansion of the film and beam, respectively. Equation (3) can be rewritten as

$$\frac{d\theta}{dx} = \frac{\Delta T (\alpha_1 - \alpha_2) \left(1 + \frac{t_1}{t_2} \right)}{t_1 + t_2}. \quad (4)$$

The equations of the microcantilever slope, θ , and deflection, v , can be obtained by integrating eq. (4) once and twice, respectively, i.e.,

$$\theta = \frac{\Delta T (\alpha_1 - \alpha_2) \left(1 + \frac{t_1}{t_2} \right)}{t_1 + t_2} x + C_1 \quad (5)$$

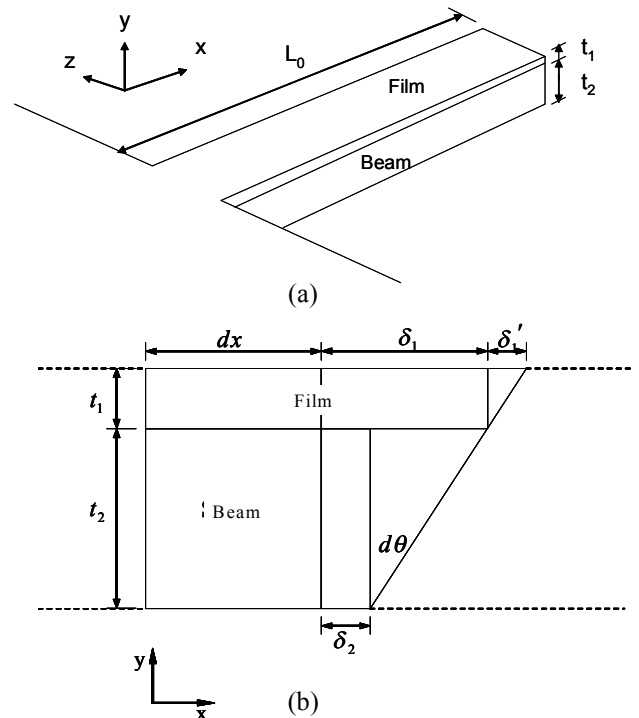

Fig. 1: Schematic diagrams of microcantilever. (a) Geometrical mode. (b) Deformed microcantilever [8].

$$v = \frac{\Delta T (\alpha_1 - \alpha_2) \left(1 + \frac{t_1}{t_2} \right)}{t_1 + t_2} \frac{x^2}{2} + C_1 x + C_2, \quad (6)$$

where C_1 and C_2 are integration constants and are evaluated from known conditions pertaining to the slope and deflection, respectively. Obviously, the slope and deflection at the fixed support end of the cantilever are zero. Under these boundary conditions, the constants C_1 and C_2 must therefore also be equal to zero. The deflection at the free end of the beam, δ , can then be calculated from

$$\delta = \frac{\Delta T (\alpha_1 - \alpha_2) \left(1 + \frac{t_1}{t_2} \right) L^2}{2(t_1 + t_2)}, \quad (7)$$

where L is the length of the microcantilever [8].

2.2 Sensing Principle

In the developed micro weather station, Pt resistors are used to be sensing electrodes and piezoresistors. The measured resistance of the Pt RTD changes as the environmental temperature changes for a temperature sensor. The microcantilever bends up as the humidity

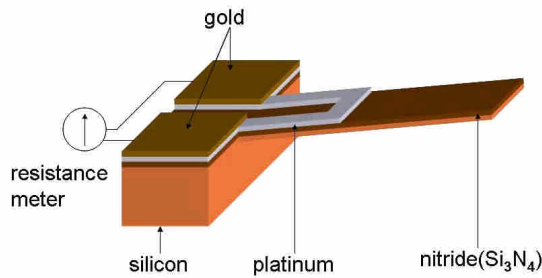

Fig. 2: Schematic illustration of resistive type of microcantilever-based sensor.

increases due to the moisture-absorbent layer of polyimide. The deformation of the microcantilever beam under different airflow velocities is also established by a platinum resistance measurement procedure, as indicated in Fig.2. The resistance measurement is based on the formula

$$R = \frac{l\rho}{A}, \quad (8)$$

where R is the resistance value, l is the resistor length, ρ is the resistivity, and A is the cross-sectional area of the resistor. From eq. (8), it is clear that the dimensions of the resistor have a direct effect on the measured resistance value. In the current study, a resistor layer is deposited on the cantilever structure.

2.3 Shape Design

Figure 3 shows the dimensions of the cantilever beam and platinum resistors considered in this study. As shown, the Pt resistors are designed on the substrate for the temperature sensing function and on the cantilever for humidity and wind velocity measurement, respectively. Note that Au is used as the bonding pads to connect the external LCR meter since the resistivity of Au is less than that of Pt and therefore the resistance effect of the leads is reduced. The dimensions of microcantilever are 400 μm in width and 4,000 μm in length.

3. FABRICATION

Figure 4 shows the fabrication process of a microcantilever-based weather station. Initially, a 1.0 μm low-stress nitride layer was deposited on both sides of a double-side-polished silicon wafer. Pt resistors were used as the sensing material of temperature and cantilever deformation in this study. Prior to deposition of the Pt, a thin layer of Cr (0.02 μm) was deposited as an adhesion layer. An Electron-beam evaporation process was then used to deposit a layer of 0.1- μm Pt. The same technique

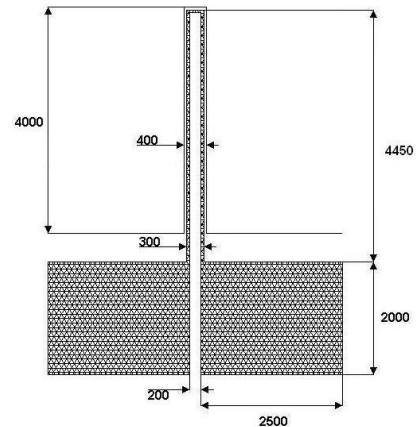

Fig.3: Dimensions of cantilever beam with Pt resistor.

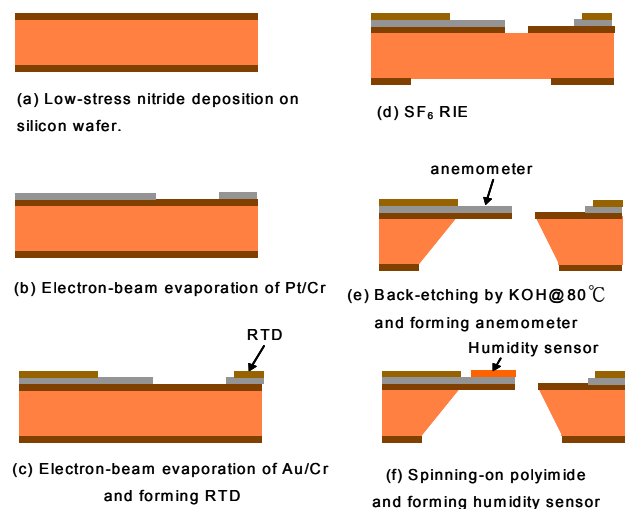
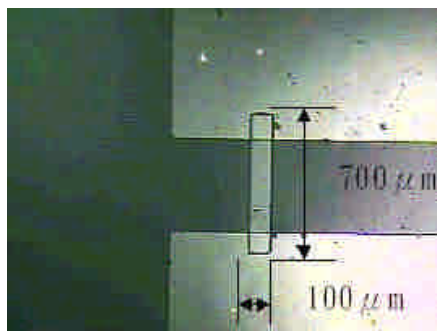

Fig. 4: Fabrication process of microcantilever-based weather station.

was again used to add a layer of Au (0.4 μm) to serve as an electrode and to provide electrical leads.

To form the microcantilever beam, the cantilever structure and the back-etching nitride mask were patterned in SF_6 RIE plasma. A freestanding structure was released in a KOH etchant (40 wt %, 85 $^\circ\text{C}$, from J. T. Baker). Following the etching process, the total microcantilever beam thickness was 20 μm (nitride: 1 μm / silicon: 19 μm). In order to increase the reliability of the microcantilever, a small thickness of silicon was retained to act as its understructure. Finally, a layer of polyimide (PW-1500, Toray Industries, Inc.) was spun-on the cantilever area and patterned as a sensing layer (15 μm after curing) for the cantilever playing a role of the humidity sensor. All cantilevers exhibit upward bending due to the stress relaxation caused by the thermal stress in the pre-fabrication process and the shrinking of the cured polyimide. Figure 5 presents photo images of the fabricated sensors considered in the current study, i.e. (a)



(a)



(b)

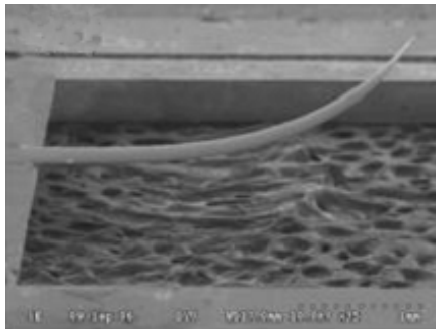

(c)

Fig. 5: Photo images of (a) RTD, (b) anemometer and (c) humidity sensor.

a temperature sensor, (b) an anemometer and (c) a humidity sensor.

4. RESULTS AND DISCUSSION

A systematic investigation of the performance of the fabricated micro weather station was conducted. The characterization of the temperature/humidity sensors was carried out in a test chamber (HRM-80, Terchy, Taiwan) using an LCR meter (4263B, Agilent Technologies), which was connected to the temperature and humidity sensors in the test chamber to record the signal response to temperature and humidity changes. The test chamber was capable of providing a humidity range from 45 % R.H. to 95 % R.H. and a temperature range from 0 °C to

100 °C. The temperature and humidity in the test chamber could be adjusted separately and could then be maintained at constant levels. The LCR meter had a working frequency in the range of 100 Hz to 100 KHz and a bias voltage of 1.5 to 2 V_{dc}. Finally, the deviation of the temperature and the relative humidity was ±0.2 °C and ± 2.0 % RH, respectively. The anemometer was carried out in a wind tunnel using different airflow velocities. The variation in the sensor resistance as the airflow passed over the cantilever was measured using the same LCR meter. For reference purposes, a Pitot tube flowmeter was also used to measure the velocity of the airflow.

4.1. Temperature Sensing Test

The resistance of the micro temperature sensor increases linearly with the input temperature. The average TCR (temperature coefficient of resistance) value is 0.004 (1/°C) with a maximum error of 2 % at a constant relative humidity of 60%. The relationship between resistance and temperature is presented in Fig. 6. The fitted equation of the data is given by:

$$T = 0.011 R - 184.72, \quad (9)$$

where T is the ambient temperature (°C) and R is the measured resistance (Ω). Note that a constant-current circuit was used for sensor operation and that only a small amount of current was allowed to pass through the resistor in order to prevent a self-heating effect.

4.2 Humidity Sensing Test

Figure 7 represents the response curve of the humidity sensor at different temperatures. During the operation of humidity sensing, the sensing layer of polyimide, top layer of the microcantilever, swells and induces compressive stress on the body structure of the microcantilever. The compressive stress resulted from swelled moisture-sensing material pushes the tip of cantilever to deflect upward. As a result, the measured resistance of the Pt resistor decreases as the humidity increases. Furthermore, the deflection level of the cantilever tip will strongly rely on the total absorbed moisture of the moisture-sensing layer. Note that the sensitivity of the humidity sensors decreases as temperature increases. Thermal effect appears inevitably in the measurement of the environmental humidity.

4.3 Anemometer Test

Figure 8 shows the relationship between the sensitivity performance and temperature for the anemometer developed in the current study. The sensitivity of the

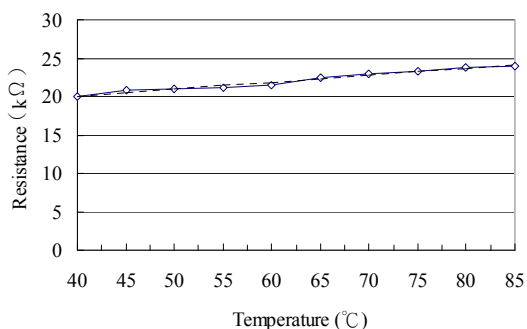

Fig. 6: TCR (temperature coefficient of resistance) test for the micro temperature sensor (TCR = 0.004 °C⁻¹).

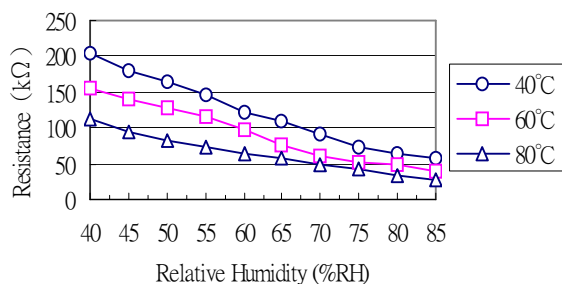

Fig. 7: Experimental result of humidity sensitivity at different temperatures.

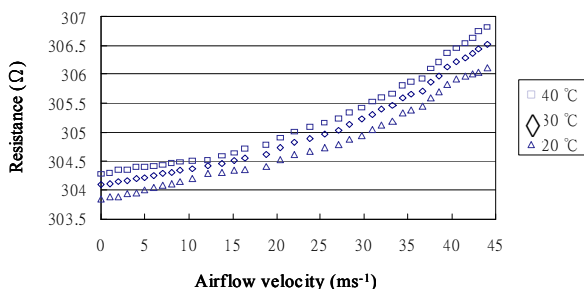

Fig. 8: Anemometer test at different temperatures.

sensors increases when temperature increases. The average sensitivity values are found to be 0.0503, 0.0533, and 0.0556 (Ω/ ms⁻¹) for three temperatures (20°, 30° and 40°, respectively). Thermal effect should also be considered for sensing the wind velocity utilizing the proposed anemometer.

5. CONCLUSIONS

The current study has successfully incorporated a microcantilever-based humidity sensor and an anemometer together with a temperature sensor by an integrated fabrication process, which simplifies the manufacture of the complex sensor. Having compensated

for the temperature drifting, the humidity and wind velocity values can be determined from the measured resistance signals.

Weather stations are widely applied to environmental monitoring. Therefore, there is a strong demand for simply-fabricated weather stations in many indoor and outdoor fields. The complex sensor presented in the study is well suited to meet the demand.

ACKNOWLEDGEMENTS

The authors would like to thank the financial support provided by the National Science Council in Taiwan (NSC 95-2211-E-212-058 and NSC 95-2218-E-006-022).

REFERENCES

- [1] B.P. Gogoi, C.H. Mastrangelo, "A low voltage force-balanced barometric pressure sensor," *IEDM*, 1996, pp. 529-532.
- [2] F. Mayer, A. Haberli, H. Jacobs, G. Ofner, O. Paul, H. Balter, "A single chip CMOS anemometer," *IEDM*, 1997, pp. 895-898.
- [3] Z.M. Rittersma, "Recent achievement in miniaturized humidity sensors – a review of transduction techniques," *Sensors and Actuators: A*, vol. 96, 2002, pp. 196-210.
- [4] C.Y. Lee, G.B. Lee, "Humidity Sensors: A Review," *Sensor Letters*, Vol. 3(1), 2005, pp. 1-14.
- [5] A. Bakker, "CMOS smart temperature sensor – an overview," *Proc. IEEE Sensors 2002*, 2002, pp. 1423-1427.
- [6] S. Chatzandroulis, A. Tserepi, D. Goustouridis, P. Normand, D. Tsoukalas, "Fabrication of single Si cantilevers using a dry release process and application in a capacitive-type humidity sensor," *Microelectronics Engineering*, Vol. 61-62, 2002, pp. 955-961.
- [7] C.Y. Lee, G.B. Lee, H.H. Liu, F.C. Huang, "MEMS-based Temperature Control Systems for PCR Applications," *The International Journal of Non-linear Sciences and Numerical Simulations*, Vol. 3 (4), 2002, pp. 215-217.
- [8] C.Y. Lee, C.H. Tsai, L.W. Chen, L.M. Fu, Y.C. Chen, "Elastic-Plastic Modeling of Heat-Treated Bimorph Micro-Cantilevers," *Journal of Microsystem Technologies*, Vol. 12, 2006, pp. 979-986.