



**HAL**  
open science

## **Trio mediates netrin-1-induced Rac1 activation in axon outgrowth and guidance.**

Anne Briançon-Marjollet, Atefeh Ghogha, Homaira Nawabi, Ibtissem Triki, Camille Auziol, Sylvie Fromont, Chantal Piché, Hervé Enslen, Karim Chebli, Jean-François Cloutier, et al.

### ► To cite this version:

Anne Briançon-Marjollet, Atefeh Ghogha, Homaira Nawabi, Ibtissem Triki, Camille Auziol, et al.. Trio mediates netrin-1-induced Rac1 activation in axon outgrowth and guidance.. *Molecular and Cellular Biology*, 2008, 28 (7), pp.2314-23. 10.1128/MCB.00998-07 . hal-00246514

**HAL Id: hal-00246514**

**<https://hal.science/hal-00246514v1>**

Submitted on 7 Feb 2008

**HAL** is a multi-disciplinary open access archive for the deposit and dissemination of scientific research documents, whether they are published or not. The documents may come from teaching and research institutions in France or abroad, or from public or private research centers.

L'archive ouverte pluridisciplinaire **HAL**, est destinée au dépôt et à la diffusion de documents scientifiques de niveau recherche, publiés ou non, émanant des établissements d'enseignement et de recherche français ou étrangers, des laboratoires publics ou privés.

1 **Trio mediates netrin-1-induced Rac1 activation in axon outgrowth and guidance**

2

3 Anne Briançon-Marjollet<sup>1</sup>, Atefeh Ghogha<sup>2</sup>, Homaira Nawabi<sup>3</sup>, Ibtissem Triki<sup>2</sup>, Camille Auziol<sup>1</sup>,  
4 Sylvie Fromont<sup>1</sup>, Chantal Piché<sup>2</sup>, Hervé Enslin<sup>6</sup>, Karim Chebli<sup>4</sup>, Jean-François Cloutier<sup>7</sup>, Valérie  
5 Castellani<sup>3</sup>, Anne Debant<sup>\*1,5</sup> and Nathalie Lamarche-Vane<sup>\*2,5</sup>

6 \*These authors contributed equally to this work

7

8 <sup>1</sup>CRBM , UMR- CNRS 5237, Université Montpellier I et II, IFR 122, Montpellier 34293, France

9 <sup>2</sup>McGill University, Department of Anatomy and Cell Biology, Montreal, Quebec, Canada H3A

10 2B2

11 <sup>3</sup>CGMC UMR-CNRS 5534, Université Claude Bernard Lyon1, 69622 Villeurbanne, France

12 <sup>4</sup>IGMM UMR-CNRS, Université Montpellier II, Montpellier 34293, France

13 <sup>6</sup>Unité mixte de recherche Santé UMR-S536, INSERM, Institut du Fer à Moulin, 75005 Paris,  
14 France

15 <sup>7</sup>Montreal Neurological Institute, McGill University, Dept. of Neurology and Neurosurgery,  
16 Montreal, Quebec, Canada H3A 2B4

17

18 <sup>5</sup>corresponding authors: Mailing address: Anne Debant, CRBM-CNRS, UMR5237, 1919 Route de  
19 Mende, 34293 Montpellier Cédex 05, France. Phone (33)-467-613-357; Fax (33)-467-521-559.

20 Emails: [anne.debant@crbm.cnrs.fr](mailto:anne.debant@crbm.cnrs.fr). Mailing address: Nathalie Lamarche, McGill University,  
21 Department of Anatomy and Cell Biology, 3540 University street, Montreal, Quebec, Canada H3A

22 2B2. Phone: 514-398-1784; Fax: 514-398-5047; email: [nathalie.lamarche@mcgill.ca](mailto:nathalie.lamarche@mcgill.ca)

23 Running title: Netrin-1 induces axon outgrowth through the GEF Trio

24 Word count (materials and methods): 1089

25 Word count (introduction, results, discussion): 3787

1 **Abstract**

2 The chemotropic guidance cue netrin-1 promotes neurite outgrowth through its receptor DCC  
3 (Deleted in Colorectal Cancer) via activation of Rac1. The guanine nucleotide exchange factor  
4 (GEF) linking netrin-1/DCC to Rac1 activation has not yet been identified. Here we show that the  
5 RhoGEF Trio mediates Rac1 activation in netrin-1 signaling. We found that Trio interacts with the  
6 netrin-1 receptor DCC in mouse embryonic brains, and that netrin-1-induced Rac1 activation in  
7 brain is impaired in the absence of Trio. Trio  $-/-$  cortical neurons fail to extend neurites in response  
8 to netrin-1, while they are able to respond to glutamate. Accordingly, netrin-1-induced commissural  
9 axon outgrowth is reduced in Trio  $-/-$  spinal cord explants and the guidance of commissural axons  
10 towards the floor plate is affected by the absence of Trio. The anterior commissure is absent in  
11 Trio-null embryos, and netrin-1/DCC-dependent axonal projections that form the internal capsule  
12 and the corpus callosum are defective in the mutants. Taken together, these findings establish Trio  
13 as a GEF that mediates netrin-1 signaling in axon outgrowth and guidance through its ability to  
14 activate Rac1.

15

## 1 **Introduction**

2           During the development of the central nervous system (CNS), axons are guided to their  
3 targets in response to molecular cues that can be either membrane-bound factors or secreted  
4 molecules, acting over short or long distances. The neuronal growth cone is a specialized structure  
5 found at the tip of the axon that integrates attractive and repulsive signals elicited by these  
6 extracellular cues and respond to them by triggering signaling pathways that regulate growth cone  
7 motility (16, 18). Netrins are a family of secreted proteins that control axon outgrowth and  
8 guidance in multiple vertebrate and invertebrate species (3). Netrin-1 is a bi-functional molecule  
9 that attracts and repels different classes of axons. In vertebrates, netrin-1 was first shown to attract  
10 commissural axons of the developing spinal cord towards the ventral midline (21, 44). Since then,  
11 netrin-1 has been shown to promote outgrowth of a wide variety of axons, including growing  
12 cortical axons (30, 41). Two families of netrin-1 receptors in mammals have been identified; the  
13 DCC (Deleted in Colorectal Cancer) family, comprising DCC and neogenin, and the UNC5 family  
14 of proteins (1, 20, 25). DCC mediates growth cone attraction induced by netrin-1 (1, 20, 25, 43)  
15 whereas the repulsive effect of netrin-1 is mediated by the UNC-5 family of netrin receptors, alone  
16 or in combination with DCC (17, 22, 35).

17           DCC is a transmembrane protein without any obvious catalytic activity in its intracellular  
18 domain, and for this reason, it was unclear until recently how the intracellular signaling machinery  
19 leading to axon outgrowth was initiated. This process has begun to be elucidated with the  
20 identification in cortical and commissural neurons of different DCC-binding proteins, including the  
21 protein tyrosine kinases FAK, Src and Fyn, the Nck adaptor protein, and PITP- $\alpha$  (26, 27, 30, 40,  
22 48). DCC acts as a tyrosine kinase-associated receptor. It is phosphorylated by Fyn on tyrosine  
23 1418 and this phosphorylation event is required for netrin-1-induced axon outgrowth (26, 34). In  
24 addition, various signaling cascades are believed to be important for netrin-1-induced axon  
25 outgrowth and guidance including the mitogen activated protein kinase (MAPK) and the

1 phosphatidylinositol pathways (3). Numerous lines of evidence have established that guidance cues  
2 also influence the motility of the growth cone by remodeling the actin cytoskeleton, through  
3 activation of the Rho family of GTPases (15). Small GTPases are molecular switches that oscillate  
4 between an inactive GDP-bound state and an active GTP-bound state, and are activated by guanine  
5 nucleotide exchange factors (GEFs) that accelerate the GDP/GTP exchange (42). Cellular and  
6 genetic studies have shown that Rac, Cdc42 and RhoG promote neurite extension and growth cone  
7 motility in response to guidance cues, while RhoA mediates neurite retraction through growth cone  
8 collapse (10). We and others have shown that the binding of netrin-1 to DCC activates the small  
9 GTPase Rac1 (28, 45), and that the adaptor protein Nck-1 is required for this activation (27). Rac1  
10 activation is required for netrin-1-induced neurite outgrowth, but the GEF responsible for this  
11 activation has not yet been identified.

12         The multidomain protein Trio is the founding member of an intriguing family of GEFs that  
13 contains two GEF domains, with the first GEF domain (GEFD1) activating Rac1 and RhoG, and  
14 GEFD2 acting on RhoA (5, 6, 9). Genetic analysis of Trio orthologs in *C. elegans* (UNC-73) and in  
15 *D.melanogaster* (D-Trio) have established Trio as a key component in the regulation of axon  
16 guidance and cell migration (2, 4, 29, 36, 46). Functional analysis indicates that the role of Trio in  
17 all organisms mainly depends on the catalytic activity of GEFD1. Moreover, D-Trio, the kinase  
18 Abl, the Abl substrate Ena, and the netrin receptor Frazzled have been shown to regulate axon  
19 guidance at the CNS midline in *Drosophila* (14). In mammals, we have shown that human Trio is a  
20 component of the NGF pathway leading to RhoG and Rac1 activation and neurite outgrowth in  
21 PC12 cells (11). Moreover, targeted disruption of Trio in mouse resulted in embryonic lethality  
22 between E15.5 and birth, suggesting that Trio is required for late embryonic development, probably  
23 by playing essential roles in neural tissue and fetal skeletal muscle formation (37). However, the  
24 function of mammalian Trio in axon guidance remains unknown. In addition, the upstream  
25 signaling pathways leading to Trio activation in mammals are still unclear.

1           Here we provide evidence that Trio is a key component of netrin-1 signaling in growth cone  
2 guidance. We show that Trio and DCC interact in embryonic brain lysates and that this association  
3 is probably mediated through the interaction with the kinase PAK1. Netrin-1-induced Rac1  
4 activation is abolished in Trio *-/-* embryonic brains. Cortical neurons are defective in extending  
5 neurites in response to netrin-1, while they respond to glutamate stimulation. Likewise, netrin-1-  
6 induced axon outgrowth is also reduced in Trio *-/-* spinal cord explants. Finally, netrin-1 and DCC-  
7 dependent neuronal projections in the developing spinal cord and in the brain, such as the anterior  
8 commissure, the internal capsule and the corpus callosum, are impaired in Trio-deficient mouse  
9 embryos.

## 1 **Materials and Methods**

### 2 **DNA constructs**

3 The GFP Trio constructs, GFP-RhoGA37, pRK5-DCC, pGEX4T2-DCC-C, pGEX2T-PAK1 and  
4 pRK5myc-PAK1 have been previously described (11, 24, 27, 28). The Nck-1 constructs have been  
5 generously provided by Dr. Louise Larose (McGill University, Montreal, Canada).

### 6 **Genotyping of Trio-null mice**

7 Ablation of the Trio gene in mice has been previously described (37). Trio heterozygous mice have  
8 been kindly provided by Dr. Michel Streuli. To obtain Trio-null embryos, female of Trio +/-  
9 Balb/C mice were crossed with Trio +/- males. Midday on the day after coitus was considered as  
10 embryonic day 0.5 (E0.5). Genomic DNA from embryo tails was prepared for genotyping using  
11 PCR method with specific oligonucleotides to detect the wt or the Trio-null allele as previously  
12 described (37).

### 13 **Cell culture and transfection**

14 Cortical neurons from E14.5 embryos were dissociated mechanically and plated on poly-L-lysine  
15 (25 µg/ml) treated coverslips at a density of 250,000 cells/well in 24-well dishes. Neurons were  
16 cultured for the indicated times in Neurobasal Medium (Invitrogen) supplemented with 1% B27  
17 (Invitrogen). Neurons were transfected with GFP or GFP-Trio constructs using LipofectAMINE  
18 2000 reagent (Invitrogen) according to manufacturer's instructions. Cells were treated as indicated  
19 with the following reagents: recombinant netrin-1 (250ng/ml, Sigma), glutamate (50µM, Sigma),  
20 blocking anti-DCC antibody (4µg/ml, Calbiochem). N1E-115 neuroblastoma cells, COS-7 cells,  
21 and HEK-293 cells were cultured and transfected as previously described (28).

### 22 **Immunoprecipitation**

23 *Immunoprecipitation of proteins expressed in HEK-293 cells:* HEK-293 cells expressing GFP-Trio  
24 and DCC were lysed in buffer containing 20 mM Hepes, pH 7.5, 100 mM NaCl, 10% glycerol, 1%  
25 Triton X-100, 20 mM NaF, 1 mM sodium orthovanadate, 1 mM phenylmethylsulfonyl fluoride

1 (PMSF), and complete protease inhibitor cocktail 1X (Roche Diagnostics). 1 mg of protein lysates  
2 were precleared with protein G–Sepharose beads at 4°C overnight. Then, the supernatants were  
3 incubated overnight at 4°C with 20 µl of protein G–Sepharose beads and 2.5 µg anti-DCC  
4 antibodies (BD Biosciences) or normal mouse IgGs. Beads were washed 3 times with ice cold lysis  
5 buffer, boiled in SDS sample buffer, and the protein samples were resolved by SDS-PAGE.

6 *Immunoprecipitation of endogenous Trio and DCC proteins from mouse embryonic brains:* Total  
7 brains of E18.5 mouse embryos were dissociated mechanically as described elsewhere (12, 31)  
8 before lysis in buffer containing 10mM Tris-HCl pH 7.5, 150 mM NaCl, 0.5% NP-40, 1 mM  
9 PMSF, 10 µg/ml aprotinin, and 10 µg/ml leupeptin. After centrifugation at 10 000g for 1 minute, 1  
10 mg of the cleared protein lysates were incubated 3 hours with 2µg of normal rabbit IgGs or 2µg of  
11 anti-Trio antibody (H120, Santa Cruz Inc.), and with 20 µl of protein G–Sepharose beads. The  
12 samples were washed 3 times with ice cold lysis buffer, boiled in SDS sample buffer, and the  
13 protein samples were resolved by SDS-PAGE. The presence of Trio and DCC in the  
14 immunoprecipitates was revealed by western-blotting using the appropriate antibodies anti-DCC  
15 (BD Biosciences Inc.) and polyclonal anti-Trio (39).

#### 16 **GST Pull-Down**

17 COS-7 transfected cells were lysed in buffer A (25 mM Hepes pH 7.5, 1% NP40, 10 mM MgCl<sub>2</sub>,  
18 100 mM NaCl, 5% Glycerol, 1 mM PMSF, protease inhibitor cocktail 1X). Lysates were then  
19 incubated for 2h at 4°C with 30µg of either GST, GST-PAK1, or GST-Nck-1 fusion proteins  
20 coupled to glutathione-sepharose beads. Total cell lysates and GST pull-down associated proteins  
21 were resolved by SDS-PAGE and transferred on nitrocellulose. Membranes were immunoblotted  
22 with the following antibodies: polyclonal anti-Trio (39), anti-Nck (BD Transduction Laboratories  
23 Inc.), anti-DCC (BD Biosciences Inc.), anti-GFP antibodies (Molecular Probes Inc), and anti-PAK1  
24 antibodies (Santa Cruz).



## 1 **Rac1 activation assay**

2 Total brains of E14.5 mouse embryos were dissociated mechanically and one half of the brain  
3 remained untreated whereas the other half was treated with netrin-1 (500 ng/ml) for the indicated  
4 times similarly to the method described elsewhere (12, 31). When indicated, they were treated with  
5 blocking anti-DCC antibody (4  $\mu$ g/ml, Calbiochem) for 10 minutes prior to netrin-1 stimulation.  
6 They were lysed in buffer A (see GST pull-down section) and lysates were then subjected to a  
7 10000g centrifugation 30 seconds at 4°C, to remove insoluble materials. Active Rac1 was pulled-  
8 down by incubating the supernatants for 1h at 4°C with GST-PAK-PBD beads (Cytoskeleton Inc.).  
9 The beads were washed with 25mM Hepes pH 7.5, 1% NP40, 30 mM MgCl<sub>2</sub>, 40 mM NaCl, 1 mM  
10 DTT, and resuspended in loading buffer. Protein samples from total cell lysates and from the GST  
11 pull-downs were resolved by SDS-PAGE and transferred on nitrocellulose. Membranes were  
12 immunoblotted with anti-Rac1 antibody (BD Transduction Laboratories Inc).

## 13 **Immunofluorescence**

14 Neurons were fixed and permeabilized as previously described (11). GFP-expressing cortical  
15 neurons were visualized using a DMR Leica microscope and a 40x PL APO lens. N1E-115 cells  
16 were fixed and permeabilized as already described (28). The cells were examined with a Axiovert  
17 135 Carl Zeiss microscope using a 63X Plan-neofluor objective lens. Images were recorded with a  
18 digital camera (DVC) and analyzed with Northern Eclipse software (Empix Imaging Inc.).

## 19 **Neurite outgrowth analysis**

20 More than 100 cortical neurons were analyzed for each condition. For each neuron, the number of  
21 neurites was counted manually, and the length of the neurites was measured using MetaMorph and  
22 NeuronJ softwares (33) modified by Volker Backer, Montpellier RIO-Imaging (unpublished data).  
23 In N1E-115 cells, a neurite was defined as a process that measured at least the length of one cell  
24 body.

1 **Explant assays**

2 Mouse dorsal spinal cord explants from wt, Trio +/- or -/- embryonic day 11.5 (E11.5) embryos  
3 were dissected and cultured in three-dimensional collagen type I (BD Biosciences) gels as  
4 described previously (47). Recombinant chick netrin-1 protein was produced and purified as  
5 described (44). Netrin-1 (500 ng/ml) was added to the culture medium at the beginning of the  
6 culture period. Images were captured after 35 h with a digital camera on a Carl Zeiss axiovert 135  
7 microscope using a 10X phase-contrast objective lens. The total length of the axon bundles and  
8 number of axons growing out of the explants were quantified using Northern Eclipse Software  
9 (Empix imaging). The experiments were performed in a blinded fashion.

10 **Spinal cord immunohistochemistry and brain histology**

11 Eosin staining and immunohistochemistry with antibodies to Nrp2 (1:100, R&D) and to DCC  
12 (1:100, BD Biosciences) were performed on horizontal or coronal 70  $\mu$ m thick vibratome sections  
13 from E17 or E18.5 brains as previously described (12). Commissural axon projections were  
14 detected by immunohistochemistry using anti-DCC antibodies (1: 200, BD Biosciences) on 20 $\mu$ m  
15 thick cryostat transverse sections from E11.5 embryos as described previously (38). Quantification  
16 analysis of axon defasciculation in Trio -/- embryos was performed on sections positioned at the  
17 forelimb of wild type and Trio -/- embryos.

## 1 **Results**

### 2 **A Trio mutant defective in Rac1 activation inhibits DCC-induced neurite outgrowth in N1E-** 3 **115 neuroblastoma cells**

4 The chemotropic guidance cue netrin-1 attracts different types of neurons and activates the  
5 GTPase Rac1 through its receptor DCC. However, the GEF responsible for Rac1 activation  
6 remains unknown. We have previously demonstrated that netrin-1 but not DCC is constitutively  
7 expressed in N1E-115 neuroblastoma cells (28). The expression of DCC in these cells induces  
8 neurite outgrowth in a netrin-1- and Rac1-dependent manner. To determine whether Trio mediates  
9 netrin-1/DCC-induced neurite outgrowth, N1E-115 cells were co-transfected with DCC, and either  
10 Trio, Trio 1-2308 lacking the kinase domain, or TrioAEP, a dominant negative form of Trio  
11 containing triple point mutations in the GEFD1 and the adjacent SH3 domain, which drastically  
12 reduces its *in vitro* exchange activity towards RhoG/Rac1 (11) (Fig. 1A). Trio and Trio1-2308 were  
13 able to induce neurite outgrowth in N1E-115 cells, either alone or together with DCC. However,  
14 the expression of TrioAEP with DCC blocked the ability of DCC to induce neurite extension (Fig.  
15 1B), suggesting that Trio mediates netrin-1/DCC-induced neurite outgrowth in N1E-115 cells. The  
16 GEFD1 domain of Trio has been previously shown to be active on both Rac1 and RhoG small  
17 GTPases (6). To determine whether RhoG is involved in netrin-1/DCC-induced neurite outgrowth,  
18 dominant negative RhoGA37 was expressed together with DCC in N1E-115 cells. RhoGA37 did  
19 not inhibit DCC-induced neurite outgrowth (Fig. 1B), in contrast to RacN17, which blocked DCC  
20 effect on neurite extension (28). Therefore, these data strongly suggest that Trio plays a role in  
21 netrin-1/DCC-regulated neurite outgrowth via Rac1 and not RhoG.

22

### 23 **Interaction of DCC and Trio**

24 To determine whether Trio interacts with DCC, GFP-Trio was co-expressed with DCC in  
25 HEK-293 cells that do not express endogenous DCC (28, 45). We found that Trio was able to

1 interact with DCC, with no band corresponding to Trio in immunoprecipitates using normal mouse  
2 IgGs (Fig. 2A). We next determined whether endogenous Trio and DCC proteins associate in  
3 mouse embryonic brains. DCC was detectable in Trio immunoprecipitates from embryonic brain  
4 lysates, which was not the case when using normal rabbit IgGs for the immunoprecipitation (Fig.  
5 2B). Stimulation of embryonic brains with netrin-1 did not significantly enhance Trio/DCC  
6 association (data not shown), suggesting that Trio binds constitutively to DCC.

7 To characterize the interaction between Trio and DCC, we examined whether Trio  
8 associates with DCC via the adaptor protein Nck-1 and the serine/threonine protein kinase PAK1.  
9 Indeed, Rac, PAK, and DOCK, the *Drosophila* ortholog of Nck, interact genetically with D-Trio  
10 during axon guidance of *Drosophila* photoreceptors (36). Furthermore, PAK1 is known to interact  
11 with the second SH3 domain of Nck-1 (8) whereas the cytoplasmic domain of DCC interacts with  
12 the first and third SH3 domains of Nck-1 (27). We performed GST-pull down experiments using  
13 either recombinant GST-Nck-1 (Fig. 2C) or GST-PAK1 (Fig. 2D) and lysates from COS-7 cells  
14 expressing GFP-Trio, DCC, Nck-1, PAK1, alone or together. Interestingly, we found that Trio  
15 alone interacted with PAK1 but not with Nck-1, whereas DCC was able to interact with both  
16 proteins (Fig. 2C and D). When PAK1 or DCC were co-expressed with Trio, Trio was now  
17 detected in the GST-Nck-1 pull-down (Fig. 2C). Finally, when DCC, Trio, PAK1 and Nck-1 were  
18 expressed together, they were all detected in the GST-Nck-1 or GST-PAK1 pull-downs (Fig. 2C  
19 and D), suggesting that Trio may associate with DCC and Nck-1 indirectly via its interaction with  
20 PAK1.

21 To characterize further the interaction of Trio with PAK1, GST-PAK1 pull-down were  
22 performed with COS-7 cells expressing various deletion mutants of Trio (Fig. 1A). As shown in  
23 Fig. 2E, Trio (1-1813) and Trio (1-1203) were able to interact with GST-PAK1, whereas Trio  
24 (1203-1813) showed no interaction. Trio (1813-3038) was also detected in the GST-PAK1 pull-  
25 down although the interaction appeared much weaker than with Trio (1-1813). These results

1 suggest that the N-terminus extremity comprising the Sec-14 and the spectrin domains of Trio (1-  
2 1203) but not the GEFD1 or the first SH3 domains of Trio (1203-1813) mediates the interaction  
3 with PAK1. Additionally, a second region of Trio that contains the GEFD2, the second SH3, and  
4 the kinase domains of Trio (1813-3038) is capable of interacting with PAK1, although to a lesser  
5 extent. Thus it seems that Trio, which is a large protein of 334 kDa with multiple signaling domains  
6 has at least two separate regions that are able to mediate the interaction with PAK1.

7

### 8 **Netrin-1-induced Rac1 activation is abolished in Trio <sup>-/-</sup> embryonic brains**

9 Netrin-1 binding to its receptor DCC has been shown in different cellular systems to induce  
10 a rapid and robust Rac1 activation, leading to neurite outgrowth (28, 45), but this has never been  
11 tested on endogenous Rac1 expressed in brain. We found that netrin-1 addition to wild type (wt)  
12 embryonic mouse brains induced a rapid Rac1 activation with a peak at 5 minutes of stimulation  
13 (Fig. 3A). Netrin-1 activation of Rac1 occurred through DCC, as a blocking DCC antibody was  
14 able to suppress netrin-1-induced Rac1 activation in embryonic brains (Fig. 3B). We then tested  
15 whether the absence of Trio affects netrin-1-induced Rac1 activation, by measuring netrin-1 effect  
16 in embryonic brains from Trio <sup>-/-</sup> mice. As shown in Fig. 3A, netrin-1 failed to activate Rac1 in  
17 Trio-null embryos, consistent with Trio being the GEF responsible for netrin-1-induced Rac1  
18 activation through its receptor DCC.

19

### 20 **Trio is necessary for netrin-1-induced axon outgrowth in cortical neurons**

21 Netrin-1 has been described as an attractant for axons of cortical explants and dissociated  
22 cortical neurons, and DCC has been shown to be expressed in developing cortical neurons (30, 40,  
23 41). To address whether Trio is required for netrin-1 to induce axon outgrowth of cortical neurons,  
24 we tested the effect of adding netrin-1 to wt or Trio-null dissociated cortical neurons. As shown in  
25 Fig. 4A, netrin-1 stimulated axon outgrowth of wt cortical neurons after 24 hours in culture. This

1 effect was mediated by the netrin-1 receptor DCC since a blocking DCC antibody completely  
2 abrogated netrin-1 effect (Fig. 4B). In contrast, netrin-1 failed to stimulate axon outgrowth of Trio-  
3 null cortical neurons (Fig. 4A and B). Consistently, analysis of the distribution of axon length in  
4 cortical neurons showed that netrin-1 significantly increased the percentage of long axons (>  
5 48 $\mu$ m) in wt but not in mutant neurons (Fig. 4C). The slight increase in the percentage of  
6 intermediary axons (16-32  $\mu$ m) observed for the mutant neurons treated with netrin-1 was not  
7 significant (Fig. 4C). The lack of netrin-1 response of Trio-deficient neurons was not due to a  
8 defect in DCC expression as both wt and mutant cortical neurons expressed similar levels of DCC  
9 proteins (data not shown). We also observed that the average axon length of Trio-null neurons in  
10 the absence of netrin-1 was reduced by 20% compared to wt neurons (Fig. 4B). Nevertheless, Trio -  
11 /- neurons were able to extend neurites in response to glutamate (Fig. 4A and B), which has been  
12 shown to stimulate growth cone motility by different pathways including Ca<sup>2+</sup>-dependent activation  
13 of Rho GTPases (19, 23, 49). Eventhough the average axon length of Trio-null neurons was lower  
14 than the one of wt neurons (Fig. 4B), the ratio of glutamate-induced axon outgrowth versus control  
15 was similar in both types of neurons (wt =1.25, -/- = 1.4), while this was not the case when  
16 comparing the ratio of netrin-1-induced outgrowth versus control between wt and mutant neurons  
17 (wt =1.48, -/=1). Analysis of the distribution of the axon length showed that glutamate stimulation  
18 of wt and mutant neurons induced in both cases the growth of long axons and significantly reduced  
19 the percentage of very short axons (Fig. 4C). These data show that Trio-null cortical neurons are  
20 able to induce axon extension in response to glutamate, while they are specifically defective in  
21 netrin-1-induced axon outgrowth.

22

### 23 **Netrin-1-induced axon outgrowth is reduced in Trio -/- dorsal spinal cord explants**

24 To further demonstrate the involvement of Trio in netrin-1/DCC-induced axon outgrowth,  
25 we added netrin-1 to dorsal spinal cord explants dissected from E11.5 Trio -/- embryos. As shown

1 in Fig. 4D, explants from wt dorsal spinal cords, treated for 35h with netrin-1, showed a robust  
2 axon outgrowth compared to untreated controls. In contrast, when explants from Trio *-/-* dorsal  
3 spinal cords were cultured in the presence of netrin-1, commissural axon outgrowth showed a 56%  
4 reduction compared to wt explants (Fig. 4D and E). To determine that the reduced response of Trio  
5 *-/-* spinal cord explants was not due to a general defect in axon outgrowth, wt or Trio *-/-* explants  
6 were cultured for 70h in the absence of netrin-1. As shown in Fig. 4E, both wt and Trio *-/-* explants  
7 were able to produce axon outgrowth in a netrin-1-independent manner. These findings  
8 demonstrate that Trio is required for netrin-1 to promote commissural axon outgrowth.

9

### 10 **Trio-deficient mouse embryos show defects in spinal cord and brain development**

11 To determine the role of Trio in netrin-1 function *in vivo*, we next examined the axonal  
12 projections of the commissural neurons in the spinal cord of wt and Trio-null littermates by  
13 immunostaining with anti-DCC antibodies (Fig. 5A). In wt embryos, commissural axons are  
14 directed ventrally towards the floor plate of the developing spinal cord, which secretes the  
15 chemoattractant netrin-1 (Fig. 5A and B) (21). In Trio *-/-* embryos, commissural axons could reach  
16 the floor plate but they appeared defasciculated in the ventral spinal cord (Fig. 5 A-F), suggesting  
17 that Trio plays a role in the guidance of these axons. In addition to defects in the developing spinal  
18 cord, the netrin-1 and DCC-null mice also present defects in several projections of the brain,  
19 namely the anterior commissure, the hippocampal commissure, the corpus callosum and the  
20 thalamo-cortical reciprocal projections in the internal capsule (13, 43). Therefore, we examined the  
21 anterior commissure in sections of Trio-null brains (Fig. 6). Serial horizontal sections of the whole  
22 brain were analyzed, and while anterior and posterior branches forming the anterior commissure  
23 were present in the wt sections, they were totally absent in the homozygous mutant embryos in all  
24 sections tested (Fig. 6A, compare a to c). Interestingly, the heterozygous mutant embryos presented  
25 an intermediate phenotype, as the anterior branch of the commissure could form but was highly

1 defasciculated, with several roots exiting the cortex at lateral positions (Fig. 6A, b). To confirm that  
2 the anterior commissure was absent in Trio  $-/-$  embryos, we analyzed different coronal sections of  
3 Trio  $+/-$  and  $-/-$  embryonic brains. As shown in Fig. 6B, defasciculated fibers were present in the  
4 heterozygous embryos but were completely absent in the Trio-null embryos (compare 6B a, b to d,  
5 e). Thus, similar to DCC and netrin-1, Trio is required for the formation of the anterior  
6 commissure.

7 We next examined the corpus callosum in Trio-null brains. We observed subtle  
8 disorganizations of the Trio  $-/-$  corpus callosum in horizontal sections, with a few defasciculated  
9 fibers being visible (Fig. 7A). However, the reconstruction of the tract of the corpus callosum with  
10 horizontal sections revealed that Trio  $-/-$  corpus callosum thickness was decreased by 35%  
11 compared to wt corpus callosum in the dorso-ventral axis (Fig. 7A). Therefore, the corpus callosum  
12 is abnormal in Trio-deficient mice. Finally, we examined the organization of axon projections in  
13 the internal capsule in horizontal brain sections. Consistent with the defects observed in netrin-1  
14 mutant mice (7), DCC staining revealed that the internal capsule was strongly disorganized in Trio  
15  $-/-$  mice. The axonal projections formed a parallel array of fibers in the wt internal capsule, but not  
16 in the Trio  $-/-$  mice, where they formed irregular and intermingled bundles (Fig. 7B). The defects  
17 observed in the Trio-null embryos were not due to a problem with the expression of netrin-1 since  
18 both in wt and in Trio-null embryos netrin-1 had the same expression pattern (data not shown).  
19 Thus, these results indicate that Trio plays a significant role in netrin-1/DCC-dependent projections  
20 in the developing spinal cord and brain.



## 1 **Discussion**

2           The findings presented here support a role for the RhoGEF Trio in axon outgrowth and  
3 guidance in mammals. We show that Trio and DCC interact in embryonic brain, most likely  
4 independently of netrin-1. Co-expression of DCC and Trio with Nck-1 and PAK1 suggests that  
5 Trio/DCC interaction probably occurs via the interaction of Trio with PAK1. Furthermore, the N-  
6 terminus region of Trio comprising the Sec-14 and the spectrin domains mediates the interaction  
7 with PAK1. However, it still remains to be determined whether the interaction between Trio and  
8 PAK1 is direct. Altogether, these data are consistent with the results obtained in *D. melanogaster*  
9 where D-Trio genetically interacts with DOCK, PAK, and Rac in controlling axon guidance of  
10 photoreceptors (36). Since Nck-1 binds to DCC through its first and third SH3 domains (27), and  
11 PAK1 binds to the second SH3 domain of Nck-1 (8), it is tempting to postulate that a cascade of  
12 molecular events implicating Nck-1/PAK interaction serves to bridge Trio to DCC. The  
13 mechanisms by which Trio becomes activated when netrin-1 binds to DCC remain unknown but  
14 may involve phosphorylation by FAK or the Src family kinase Fyn (32, 34).

15           We show here for the first time that netrin-1 treatment of embryonic brains stimulates Rac1  
16 activity. This Rac1 activation is completely abolished in the absence of Trio, suggesting that Trio-  
17 related kalirin does not compensate for the lack of Trio in brain. Trio also activates nucleotide  
18 exchange on both RhoG and Rac1 through its first GEFD1 domain (6). Unfortunately, we could not  
19 determine whether netrin-1 is able to stimulate RhoG activity in mouse brains because of the lack  
20 of specific anti-RhoG antibodies. However, altering the specific RhoG pathway did not inhibit  
21 DCC-induced neurite outgrowth in N1E-115 cells, suggesting that it is unlikely that RhoG mediates  
22 DCC-induced Rac1 activation.

23           We have previously shown that human Trio plays a role in NGF-induced neurite outgrowth  
24 (11), but the role of mammalian Trio in axon outgrowth and guidance remained poorly  
25 characterized. We took advantage of the Trio-null mice to examine the axon outgrowth and

1 guidance of Trio-deficient neurons. Our findings argue for a specific role of the GEF Trio in axon  
2 outgrowth induced by netrin-1. The cortical neurons of the Trio-null mice are defective in  
3 extending neurites in response to netrin-1, while they are able to extend neurites in response to  
4 glutamate, which has been proposed to act through different signaling pathways, including Ca<sup>2+</sup>-  
5 dependent activation of Rho GTPases (19, 23, 49). Likewise, commissural axon outgrowth from  
6 Trio <sup>-/-</sup> spinal cord explants is also reduced in response to netrin-1, while netrin-1-independent  
7 outgrowth is not affected. These data show that Trio-null neurons are not completely defective in  
8 neurite outgrowth but are specifically impaired in their axon response to netrin-1.

9         Netrin-1 and DCC-null mice present several defects in the developing spinal cord and brain  
10 commissures (13, 43). We have compared these defects with those observed in the Trio-null mice  
11 (Table 1). Interestingly, Trio <sup>-/-</sup> embryos show defects in the anterior commissure that are more  
12 severe than those observed in DCC- and netrin-1-deficient mice, suggesting that Trio plays a  
13 prominent role in brain morphogenesis. In addition, the observations that Trio heterozygous mutant  
14 embryos present an intermediate phenotype with defasciculation of the axons of the anterior  
15 commissure suggest that Trio is involved not only in netrin-1-induced axon outgrowth but also in  
16 guidance. The spinal commissural axons of the netrin-1- and DCC-mutant mice also show major  
17 deviations from normal trajectories only in the ventral part of the spinal cord. In the absence of  
18 Trio, the phenotype is milder, but the axon bundles are clearly defasciculated when approaching the  
19 floor plate, showing that Trio plays a role in the netrin-1-dependent pathfinding of commissural  
20 axons. Similarly, Trio contributes to the guidance of cortico-cortical projections along the corpus  
21 callosum, although corpus callosum defects appear milder in Trio <sup>-/-</sup> embryos than in netrin-1 or  
22 DCC mutant mice. In the case of the corpus callosum, one could speculate that two populations of  
23 axons can be differentiated among the cortical axons projecting along the corpus callosum, one  
24 population in which netrin-1 response is totally dependent on Trio and would thus be defective in  
25 Trio <sup>-/-</sup> brains, and another population that is not dependent on Trio and thus could project

1 normally. Alternatively, Trio could be partially redundant with another protein in all these neurons.  
2 In addition to cortico-cortical projections, cortical axons also project to sub-cortical targets,  
3 including the thalamus and the spinal cord. These sub-cortical projections navigate in the internal  
4 capsule, in which also extend reciprocal thalamic projections in route towards the cortex. Netrin-1  
5 has also been implicated in both cortico-thalamic and thalamo-cortical axon guidance (7, 41).  
6 Interestingly, we have detected a disorganization of the internal capsule in Trio *-/-* brains, which is  
7 also observed in netrin-1-deficient mice, supporting the hypothesis that Trio is implicated in both  
8 reciprocal pathways. In conclusion, the defects presented in the Trio *-/-* mice are observed in the  
9 same classes of axons that are affected in netrin-1 and DCC-deficient animals, eventhough the  
10 phenotypes are generally milder, except for the anterior commissure (Table 1).

11 Much evidence now suggests that several intracellular pathways, including MAPK,  
12 phosphatidylinositol signaling, tyrosine phosphorylation, and activation of Rac1, act in concert to  
13 mediate the response of axons to netrin-1 (3). Therefore, it is not surprising that the *in vivo*  
14 phenotypes of the Trio-null embryos do not reproduce exactly those seen in the netrin-1 and DCC-  
15 null mice because the Trio-null embryos are defective in Rac1 activation, but not in the other  
16 netrin-1-activated signaling pathways. Future studies will help to define how these signaling  
17 pathways are interconnected in order to achieve a directed response of axons to netrin-1.

18 In conclusion, our study shows that Trio mediates netrin-1/DCC-induced Rac1 activation  
19 and that the role of mammalian Trio in axon guidance reflects the conserved signaling mechanisms  
20 involved in neural development throughout evolution.

## 1 **Acknowledgments**

2 We thank Jean-Michel Bellanger, Susanne Schmidt, Jean-Antoine Girault, Stéphane Richard, John  
3 J. Bergeron, and Eric Danek for helpful discussions and for critical reading of the manuscript, and  
4 Tim Kennedy and Frédéric Charron for advices on spinal cord dissection. We also thank C. Jacquet  
5 and M. Plays for their technical assistance in maintaining our Trio -/- mice housed in the animal  
6 facility of the IGMM/IFR122 and Pierre Travo and all the members of the RIO-Imaging facility for  
7 their constant interest and support. This work was supported by grants from the CNRS (A.D.), The  
8 Ligue Nationale Contre le Cancer « équipe labellisée » (A.D.), the CIHR (N.L-V and J.F.C),  
9 FQRNT (J.F.C.) and the FRSQ-INSERM (A.D. and N. L.-V.). A.B.M. was supported by a  
10 predoctoral fellowship from the Ministère de la Recherche et de l'Enseignement Supérieur,  
11 followed by an Association pour la Recherche contre le Cancer fellowship. N.L-V. is a recipient of  
12 a CIHR new investigator award. J.F.C holds a Canada Research Chair Tier II.

## 1 **References**

- 2 1. **Ackerman, S. L., L. P. Kozak, S. A. Przyborski, L. A. Rund, B. B. Boyer, and B.**  
3 **B. Knowles.** 1997. The mouse rostral cerebellar malformation gene encodes an UNC-  
4 5-like protein. *Nature* **386**:838-842.
- 5 2. **Awasaki, T., M. Saito, M. Sone, E. Suzuki, R. Sakai, K. Ito, and C. Hama.** 2000.  
6 The *Drosophila* trio plays an essential role in patterning of axons by regulating their  
7 directional extension. *Neuron* **26**:119-131.
- 8 3. **Barallobre, M. J., M. Pascual, J. A. Del Rio, and E. Soriano.** 2005. The Netrin  
9 family of guidance factors: emphasis on Netrin-1 signalling. *Brain Res Brain Res Rev*  
10 **49**:22-47.
- 11 4. **Bateman, J., H. Shu, and D. Van Vactor.** 2000. The guanine nucleotide exchange  
12 factor trio mediates axonal development in the *Drosophila* embryo. *Neuron* **26**:93-  
13 106.
- 14 5. **Bellanger, J. M., J. B. Lazaro, S. Diriong, A. Fernandez, N. Lamb, and A.**  
15 **Debant.** 1998. The two guanine nucleotide exchange factor domains of Trio link the  
16 Rac1 and the RhoA pathways in vivo. *Oncogene* **16**:147-152.
- 17 6. **Blangy, A., E. Vignal, S. Schmidt, A. Debant, C. Gauthier-Rouviere, and P. Fort.**  
18 2000. TrioGEF1 controls Rac- and Cdc42-dependent cell structures through the direct  
19 activation of rhoG. *J Cell Sci* **113**:729-739.
- 20 7. **Braisted, J. E., S. M. Catalano, R. Stimac, T. E. Kennedy, M. Tessier-Lavigne, C.**  
21 **J. Shatz, and D. D. O'Leary.** 2000. Netrin-1 promotes thalamic axon growth and is  
22 required for proper development of the thalamocortical projection. *J Neurosci*  
23 **20**:5792-5801.
- 24 8. **Buday, L., L. Wunderlich, and P. Tamas.** 2002. The Nck family of adapter  
25 proteins: regulators of actin cytoskeleton. *Cell Signal* **14**:723-731.

- 1 9. **Debant, A., C. Serra-Pages, K. Seipel, S. O'Brien, M. Tang, S. H. Park, and M.**  
2 **Streuli.** 1996. The multidomain protein Trio binds the LAR transmembrane tyrosine  
3 phosphatase, contains a protein kinase domain, and has separate rac- specific and rho-  
4 specific guanine nucleotide exchange factor domains. *Proc Natl Acad Sci U S A*  
5 **93:5466-5471.**
- 6 10. **Dickson, B. J.** 2001. Rho GTPases in growth cone guidance. *Curr Opin Neurobiol*  
7 **11:103-110.**
- 8 11. **Estrach, S., S. Schmidt, S. Diriong, A. Penna, A. Blangy, P. Fort, and A. Debant.**  
9 2002. The Human Rho-GEF Trio and Its Target GTPase RhoG Are Involved in the  
10 NGF Pathway, Leading to Neurite Outgrowth. *Curr Biol* **12:307-312.**
- 11 12. **Falk, J., A. Bechara, R. Fiore, H. Nawabi, H. Zhou, C. Hoyo-Becerra, M. Bozon,**  
12 **G. Rougon, M. Grumet, A. W. Puschel, J. R. Sanes, and V. Castellani.** 2005. Dual  
13 functional activity of semaphorin 3B is required for positioning the anterior  
14 commissure. *Neuron* **48:63-75.**
- 15 13. **Fazeli, A., S. L. Dickinson, M. L. Hermiston, R. V. Tighe, R. G. Steen, C. G.**  
16 **Small, E. T. Stoeckli, K. Keino-Masu, M. Masu, H. Rayburn, J. Simons, R. T.**  
17 **Bronson, J. I. Gordon, M. Tessier-Lavigne, and R. A. Weinberg.** 1997. Phenotype  
18 of mice lacking functional Deleted in colorectal cancer (Dcc) gene. *Nature* **386:796-**  
19 **804.**
- 20 14. **Forsthoefel, D. J., E. C. Liebl, P. A. Kolodziej, and M. A. Seeger.** 2005. The  
21 Abelson tyrosine kinase, the Trio GEF and Enabled interact with the Netrin receptor  
22 Frazzled in *Drosophila*. *Development* **132:1983-1994.**
- 23 15. **Govek, E. E., S. E. Newey, and L. Van Aelst.** 2005. The role of the Rho GTPases in  
24 neuronal development. *Genes Dev* **19:1-49.**

- 1 16. **Guan, K. L., and Y. Rao.** 2003. Signalling mechanisms mediating neuronal  
2 responses to guidance cues. *Nat Rev Neurosci* **4**:941-956.
- 3 17. **Hong, K., L. Hinck, M. Nishiyama, M. M. Poo, M. Tessier-Lavigne, and E. Stein.**  
4 1999. A ligand-gated association between cytoplasmic domains of UNC5 and DCC  
5 family receptors converts netrin-induced growth cone attraction to repulsion. *Cell*  
6 **97**:927-941.
- 7 18. **Huber, A. B., A. L. Kolodkin, D. D. Ginty, and J. F. Cloutier.** 2003. Signaling at  
8 the growth cone: ligand-receptor complexes and the control of axon growth and  
9 guidance. *Annu Rev Neurosci* **26**:509-563.
- 10 19. **Jin, M., C. B. Guan, Y. A. Jiang, G. Chen, C. T. Zhao, K. Cui, Y. Q. Song, C. P.**  
11 **Wu, M. M. Poo, and X. B. Yuan.** 2005. Ca<sup>2+</sup>-dependent regulation of rho GTPases  
12 triggers turning of nerve growth cones. *J Neurosci* **25**:2338-2347.
- 13 20. **Keino-Masu, K., M. Masu, L. Hinck, E. D. Leonardo, S. S. Chan, J. G. Culotti,**  
14 **and M. Tessier-Lavigne.** 1996. Deleted in Colorectal Cancer (DCC) encodes a netrin  
15 receptor. *Cell* **87**:175-185.
- 16 21. **Kennedy, T. E., T. Serafini, J. R. de la Torre, and M. Tessier-Lavigne.** 1994.  
17 Netrins are diffusible chemotropic factors for commissural axons in the embryonic  
18 spinal cord. *Cell* **78**:425-435.
- 19 22. **Killeen, M., J. Tong, A. Krizus, R. Steven, I. Scott, T. Pawson, and J. Culotti.**  
20 2002. UNC-5 function requires phosphorylation of cytoplasmic tyrosine 482, but its  
21 UNC-40-independent functions also require a region between the ZU-5 and death  
22 domains. *Dev Biol* **251**:348-366.
- 23 23. **Kreibich, T. A., S. H. Chalasani, and J. A. Raper.** 2004. The neurotransmitter  
24 glutamate reduces axonal responsiveness to multiple repellents through the activation  
25 of metabotropic glutamate receptor 1. *J Neurosci* **24**:7085-7095.

- 1 24. **Lamarche, N., N. Tapon, L. Stowers, P. D. Burbelo, P. Aspenstrom, T. Bridges,**  
2 **J. Chant, and A. Hall.** 1996. Rac and Cdc42 induce actin polymerization and G1 cell  
3 cycle progression independently of p65PAK and the JNK/SAPK MAP kinase  
4 cascade. *Cell* **87**:519-529.
- 5 25. **Leonardo, E. D., L. Hinck, M. Masu, K. Keino-Masu, S. L. Ackerman, and M.**  
6 **Tessier-Lavigne.** 1997. Vertebrate homologues of *C. elegans* UNC-5 are candidate  
7 netrin receptors. *Nature* **386**:833-838.
- 8 26. **Li, W., J. Lee, H. G. Vikis, S. H. Lee, G. Liu, J. Aurandt, T. L. Shen, E. R.**  
9 **Fearon, J. L. Guan, M. Han, Y. Rao, K. Hong, and K. L. Guan.** 2004. Activation  
10 of FAK and Src are receptor-proximal events required for netrin signaling. *Nat*  
11 *Neurosci* **7**:1213-1221.
- 12 27. **Li, X., M. Meriane, I. Triki, M. Shekarabi, T. E. Kennedy, L. Larose, and N.**  
13 **Lamarche-Vane.** 2002. The adaptor protein Nck-1 couples the netrin-1 receptor DCC  
14 (deleted in colorectal cancer) to the activation of the small GTPase Rac1 through an  
15 atypical mechanism. *J Biol Chem* **277**:37788-37797.
- 16 28. **Li, X., E. Saint-Cyr-Proulx, K. Aktories, and N. Lamarche-Vane.** 2002. Rac1 and  
17 Cdc42 but not RhoA or Rho kinase activities are required for neurite outgrowth  
18 induced by the Netrin-1 receptor DCC (deleted in colorectal cancer) in N1E-115  
19 neuroblastoma cells. *J Biol Chem* **277**:15207-15214.
- 20 29. **Liebl, E. C., D. J. Forsthoefel, L. S. Franco, S. H. Sample, J. E. Hess, J. A.**  
21 **Cowger, M. P. Chandler, A. M. Shupert, and M. A. Seeger.** 2000. Dosage-  
22 sensitive, reciprocal genetic interactions between the Abl tyrosine kinase and the  
23 putative GEF trio reveal trio's role in axon pathfinding. *Neuron* **26**:107-18.



- 1 30. **Liu, G., H. Beggs, C. Jurgensen, H. T. Park, H. Tang, J. Gorski, K. R. Jones, L.**  
2 **F. Reichardt, J. Wu, and Y. Rao.** 2004. Netrin requires focal adhesion kinase and  
3 Src family kinases for axon outgrowth and attraction. *Nat Neurosci* **7**:1222-1232.
- 4 31. **Llambi, F., F. C. Lourenco, D. Gozuacik, C. Guix, L. Pays, G. Del Rio, A.**  
5 **Kimchi, and P. Mehlen.** 2005. The dependence receptor UNC5H2 mediates  
6 apoptosis through DAP-kinase. *Embo J* **24**:1192-1201.
- 7 32. **Medley, Q. G., E. G. Buchbinder, K. Tachibana, H. Ngo, C. Serra-Pages, and M.**  
8 **Streuli.** 2003. Signaling between focal adhesion kinase and trio. *J Biol Chem*  
9 **278**:13265-13270.
- 10 33. **Meijering, E., M. Jacob, J. C. Sarria, P. Steiner, H. Hirling, and M. Unser.** 2004.  
11 Design and validation of a tool for neurite tracing and analysis in fluorescence  
12 microscopy images. *Cytometry A* **58**:167-176.
- 13 34. **Meriane, M., J. Tcherkezian, C. A. Webber, E. I. Danek, I. Triki, S. McFarlane,**  
14 **E. Bloch-Gallego, and N. Lamarche-Vane.** 2004. Phosphorylation of DCC by Fyn  
15 mediates Netrin-1 signaling in growth cone guidance. *J Cell Biol* **167**:687-698.
- 16 35. **Merz, D. C., H. Zheng, M. T. Killeen, A. Krizus, and J. G. Culotti.** 2001. Multiple  
17 signaling mechanisms of the UNC-6/netrin receptors UNC-5 and UNC-40/DCC in  
18 vivo. *Genetics* **158**:1071-1080.
- 19 36. **Newsome, T. P., S. Schmidt, G. Dietzl, K. Keleman, B. Asling, A. Debant, and B.**  
20 **J. Dickson.** 2000. Trio combines with dock to regulate Pak activity during  
21 photoreceptor axon pathfinding in *Drosophila*. *Cell* **101**:283-294.
- 22 37. **O'Brien, S. P., K. Seipel, Q. G. Medley, R. Bronson, R. Segal, and M. Streuli.**  
23 2000. Skeletal muscle deformity and neuronal disorder in Trio exchange factor-  
24 deficient mouse embryos. *Proc Natl Acad Sci U S A* **97**:12074-12078.

- 1 38. **Okada, A., F. Charron, S. Morin, D. S. Shin, K. Wong, P. J. Fabre, M. Tessier-**  
2 **Lavigne, and S. K. McConnell.** 2006. Boc is a receptor for sonic hedgehog in the  
3 guidance of commissural axons. *Nature* **444**:369-373.
- 4 39. **Portales-Casamar, E., A. Briancon-Marjollet, S. Fromont, R. Triboulet, and A.**  
5 **Debant.** 2006. Identification of novel neuronal isoforms of the Rho-GEF Trio. *Biol*  
6 *Cell* **98**:183-193.
- 7 40. **Ren, X. R., G. L. Ming, Y. Xie, Y. Hong, D. M. Sun, Z. Q. Zhao, Z. Feng, Q.**  
8 **Wang, S. Shim, Z. F. Chen, H. J. Song, L. Mei, and W. C. Xiong.** 2004. Focal  
9 adhesion kinase in netrin-1 signaling. *Nat Neurosci* **7**:1204-1212.
- 10 41. **Richards, L. J., S. E. Koester, R. Tuttle, and D. D. O'Leary.** 1997. Directed  
11 growth of early cortical axons is influenced by a chemoattractant released from an  
12 intermediate target. *J Neurosci* **17**:2445-2458.
- 13 42. **Rossman, K. L., C. J. Der, and J. Sondek.** 2005. GEF means go: turning on RHO  
14 GTPases with guanine nucleotide-exchange factors. *Nat Rev Mol Cell Biol* **6**:167-  
15 180.
- 16 43. **Serafini, T., S. A. Colamarino, E. D. Leonardo, H. Wang, R. Beddington, W. C.**  
17 **Skarnes, and M. Tessier-Lavigne.** 1996. Netrin-1 is required for commissural axon  
18 guidance in the developing vertebrate nervous system. *Cell* **87**:1001-1014.
- 19 44. **Serafini, T., T. E. Kennedy, M. J. Galko, C. Mirzayan, T. M. Jessell, and M.**  
20 **Tessier-Lavigne.** 1994. The netrins define a family of axon outgrowth-promoting  
21 proteins homologous to *C. elegans* UNC-6. *Cell* **78**:409-424.
- 22 45. **Shekarabi, M., and T. E. Kennedy.** 2002. The netrin-1 receptor DCC promotes  
23 filopodia formation and cell spreading by activating Cdc42 and Rac1. *Mol Cell*  
24 *Neurosci* **19**:1-17.

- 1 46. **Steven, R., T. J. Kubiseski, H. Zheng, S. Kulkarni, J. Mancillas, A. Ruiz Morales,**  
2 **C. W. Hogue, T. Pawson, and J. Culotti.** 1998. UNC-73 activates the Rac GTPase  
3 and is required for cell and growth cone migrations in *C. elegans*. *Cell* **92**:785-795.
- 4 47. **Tessier-Lavigne, M., M. Placzek, A. G. Lumsden, J. Dodd, and T. M. Jessell.**  
5 1988. Chemotropic guidance of developing axons in the mammalian central nervous  
6 system. *Nature* **336**:775-778.
- 7 48. **Xie, Y., Y. Q. Ding, Y. Hong, Z. Feng, S. Navarre, C. X. Xi, X. J. Zhu, C. L.**  
8 **Wang, S. L. Ackerman, D. Kozlowski, L. Mei, and W. C. Xiong.** 2005.  
9 Phosphatidylinositol transfer protein-alpha in netrin-1-induced PLC signalling and  
10 neurite outgrowth. *Nat Cell Biol* **7**:1124-1132.
- 11 49. **Zheng, J. Q., J. J. Wan, and M. M. Poo.** 1996. Essential role of filopodia in  
12 chemotropic turning of nerve growth cone induced by a glutamate gradient. *J*  
13 *Neurosci* **16**:1140-1149.

14

15

1

## 2 **Figure Legends**

### 3 **Figure 1: Trio defective in Rac1 activation inhibits DCC-induced neurite outgrowth in N1E-** 4 **115 neuroblastoma cells.**

5 (A) Schematic of Trio and Trio mutant proteins. TrioAEP is a dominant negative form of Trio, and  
6 corresponds to Trio (1-2308) containing triple mutations (stars) in the GEFD1 and adjacent SH3  
7 domain. DH: Dbl homology; PH: Pleckstrin homology; SH3: Src homology 3, Ig: Immunoglobulin  
8 g (B) N1E-115 cells were transfected with the indicated plasmids and cells exhibiting neurite  
9 outgrowth were counted 24 hours after transfection. The values correspond to the average of at  
10 least three independent experiments. Error bars represent standard deviation (SD).

11

### 12 **Figure 2: Interaction of DCC and Trio**

13 (A) Lysates of HEK-293 cells transfected with pEGFP-Trio and pRK5-DCC were submitted to  
14 immunoprecipitation (IP) using anti-DCC antibodies (DCC) or mouse Immunoglobulin G (IgG)  
15 coupled to protein G-sepharose beads. Immunoprecipitated proteins (IP) and 10% of the total cell  
16 lysates (TCL) were submitted to SDS-PAGE, and GFP-Trio and DCC were detected by western  
17 blotting using anti-DCC and anti-GFP antibodies. (B) Lysates of E18.5 mouse brains were  
18 submitted to immunoprecipitation (IP) using anti-Trio or normal rabbit IgGs coupled to protein G-  
19 Sepharose beads. Immunoprecipitated proteins and 10% of the total cell lysates (TCL) were  
20 submitted to SDS-PAGE, and the presence of DCC and Trio was detected by western blotting  
21 using the appropriate antibodies. (C and D) Lysates of COS-7 cells transfected with pRK5 (EV),  
22 pRK5-DCC, pEGFP-Trio, pRK5-HA-Nck-1 or pRK5myc-PAK1, alone or as indicated, were  
23 incubated with GST, GST-Nck (C) or GST-PAK (D). GST pull-down proteins (pull-down) and  
24 10% of the total cell lysates (TCL) were submitted to SDS-PAGE, and proteins were detected by  
25 Western blotting analysis using anti-DCC, anti-GFP, anti-PAK1 and anti-Nck-1 antibodies. (E)

1 Lysates of COS-7 cells transfected with pEGFP-Trio (1-1813), -Trio (1813-3038), -Trio (1-1203)  
2 or -Trio (1203-1813) were incubated with GST or GST-PAK. GST pull-down proteins (pull-down)  
3 and 8% of the total cell lysates (TCL) were submitted to SDS-PAGE, and proteins were detected by  
4 Western blotting analysis using anti-GFP antibodies.

5

### 6 **Figure 3: Netrin-1-induced Rac1 activation is impaired in Trio null-embryonic brains**

7 (A) GTP-loaded Rac1 was pulled-down using GST-PAK-PBD from lysates of +/+ or Trio -/-  
8 embryonic brains treated or not with netrin-1 for the indicated time. Upper panel, GTP-bound Rac1  
9 was detected by western blotting using anti-Rac1 antibodies. Lower panel, total cell lysates probed  
10 for Rac1 indicated equal amounts of GTPase. Quantification of Rac1 activity corresponds to the  
11 average of at least three independent experiments. P-value < 0.01. (B) As in A, except that DCC  
12 blocking antibodies (4  $\mu$ g/ml) were added before netrin-1 stimulation (5 minutes). Mouse anti-GFP  
13 antibodies were used as a negative control and had no effect on netrin-1-induced Rac1 activation.  
14 Quantification of Rac1 activity corresponds to the average of at least three independent  
15 experiments. P-value = 0.012 (Student T-Test). For (A) and (B) panels, error bars represent SD.

16

### 17 **Figure 4: Trio is required for netrin-1-induced axon outgrowth**

18 (A) Neurite outgrowth of +/+ or Trio -/- cortical neurons expressing GFP at DIV 1.5 treated with  
19 control buffer, netrin-1 or glutamate for 24 hours. Scale bar, 25 $\mu$ m. (B) Quantification of average  
20 axon length of cortical neurons presented in panel A. Values are represented as a percentage of  
21 average axon length of wt cortical neurons at DIV 1.5 incubated with control buffer. When  
22 indicated, neurons were incubated with control Igs or DCC blocking antibodies before netrin-1  
23 addition. All P values are < 0.001. \*\* represents a comparison to wt neurons expressing GFP,  
24 except for the dotted line that refers to GFP transfected Trio-null neurons. n=8 for +/+ and n=10 for  
25 -/- embryos. (C) Distribution of axon length from panel B. (D) E11.5 dorsal spinal cord explants

1 from +/+ or Trio -/- embryos were incubated with control buffer or netrin-1 for 35h. Scale bar,  
2 100µm. (E) Quantification of the average length of axon bundles per explant after 35h incubation  
3 with netrin-1 (n= 10 for Trio +/+, n=4 for Trio -/-. \*\*, p<0.001) or after 70h in the absence of  
4 netrin-1 (n=3 for +/+ and -/-).

5

### 6 **Figure 5: Commissural axon projections are defective in Trio-null embryos**

7 (A) Upper panels: Trajectories of commissural axons are visualized using anti-DCC antibodies in  
8 sections of +/+ or Trio -/- E11.5 embryos. Lower panels: Enlargement of the corresponding images.  
9 Scale bar, 80µm. (B) Left: schematic representing normal commissural axons that project from the  
10 dorsal spinal cord towards the ventral floor plate. Right: In Trio -/- embryos, commissural axons  
11 are defasciculated when they reach the ventral floor plate (see arrows in A and B). (C and D) The  
12 thickness of axon bundles in the dorsal and ventral spinal cords was quantified by measuring the  
13 width of the DCC-stained axons (red) relative to the width of the spinal cord (blue) as depicted in  
14 (D). (E and F) Axon defasciculation in Trio -/- embryos was quantified by measuring DCC-stained  
15 area (red) relative to the total area of the spinal cord (blue) as depicted in (F). p<0.001, Student T-  
16 Test. Error bars represent SD. (n=5 for +/+ and n=7 for -/-).

17

### 18 **Figure 6: The anterior commissure is absent in Trio-null embryos**

19 (A) Neuropilin2 (Nrp2) immunostaining on horizontal serial brain sections from E17 +/+ (a), +/-  
20 (b) or -/- (c) embryos (n=6 for +/+ and -/-, n=4 for +/-). In the heterozygous embryos, the anterior  
21 branch of the commissure (AC) is defasciculated, which is illustrated by several roots exiting the  
22 cortex at lateral positions (see arrows in b). In the Trio-null embryos, the commissure is absent (c).  
23 Scale bar, 80µm. (B) Eosin staining on coronal brain sections from E17 +/- (a, b, c) and -/- (d, e, f)  
24 embryos. Defasciculated fibers are present in the heterozygous embryos (b, white arrows), whereas

1 they are absent in the Trio-null embryos (e). In more posterior sections, anterior commissural fibers  
2 are detected in the heterozygous (c, black arrows) but not in Trio-null brains (f). Scale bar, 300 $\mu$ m.

3

#### 4 **Figure 7: Defects in the corpus callosum and internal capsule in Trio-null embryos**

5 A) DCC immunostaining on horizontal brain sections from E18.5 +/+ and Trio -/- embryos  
6 showing the corpus callosum (CC) region. In the Trio-null embryos, the corpus callosum appears  
7 slightly abnormal with some defasciculated fibers (arrows) in the horizontal sections. The right  
8 panel represents the quantification of corpus callosum thickness along the dorso-ventral axis in +/+  
9 and Trio -/- embryos. Quantification has been obtained by counting the number of horizontal  
10 sections in which the corpus callosum is present divided by the total number of sections. The  
11 corpus callosum thickness of the Trio-null embryos is expressed relative to the thickness of the wt  
12 corpus callosum along the dorso-ventral axis. n=5 for +/+ embryos, n=8 for Trio -/- embryos. P-  
13 value<0.05. Scale bar, 50 $\mu$ m. B) DCC immunostaining on horizontal brain sections from E18.5 +/+  
14 and Trio -/- embryos showing the internal capsule (IC) region. DCC positive fibers are clearly  
15 disorganized in the internal capsule of Trio -/- embryos. Two different examples are shown. This  
16 defect was observed in 8 out of 9 Trio -/- embryos. Scale bar, 50 $\mu$ m.

17

#### 18 **Table 1: Comparison of the phenotypes observed in the Trio-null embryos with netrin-1- and** 19 **DCC-deficient embryos**

20 Four different netrin-1 and DCC-dependent neuronal projections were examined in the Trio-null  
21 embryos, namely the spinal commissural axon projections, the anterior commissure, the corpus  
22 callosum and the internal capsule. The figure depicts the comparison between the phenotypes  
23 observed in Trio-, netrin-1-, and DCC-deficient embryos according to (7, 13, 43). WT: wild-type

24

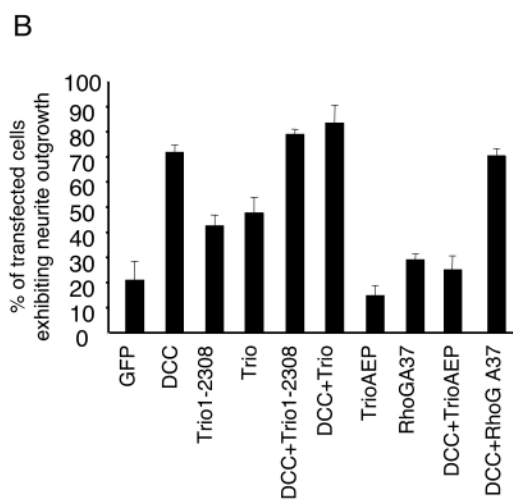
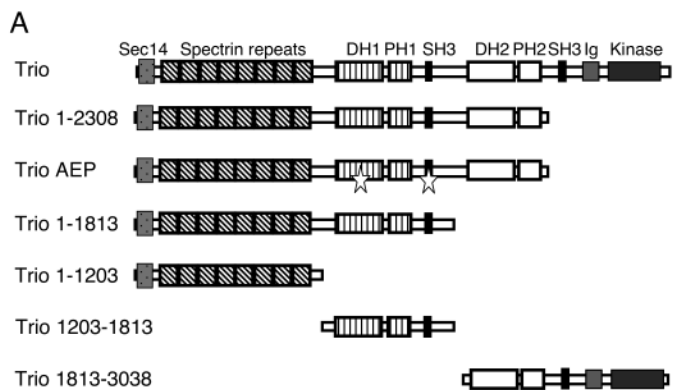



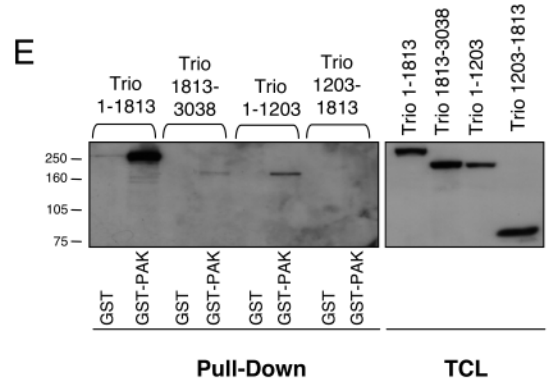
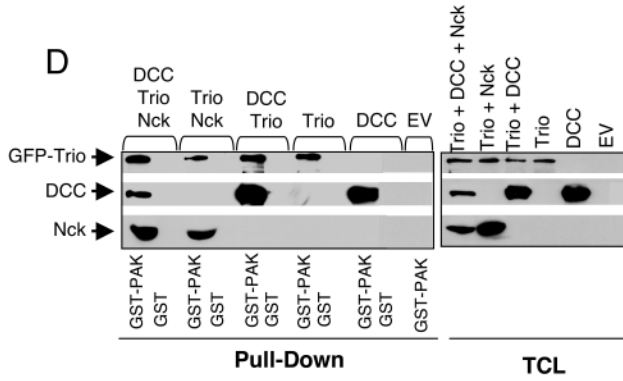
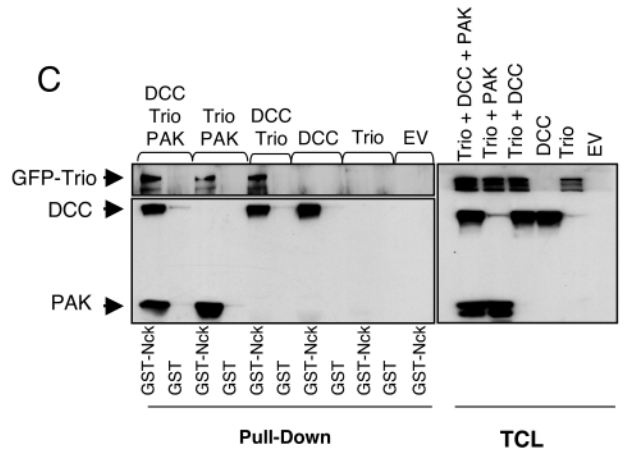
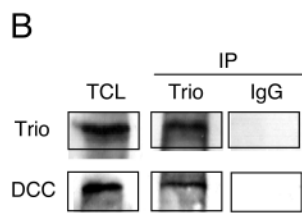
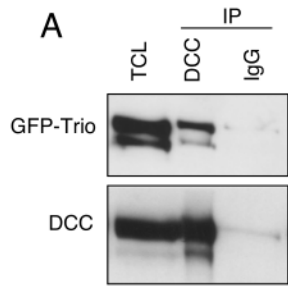

**A**

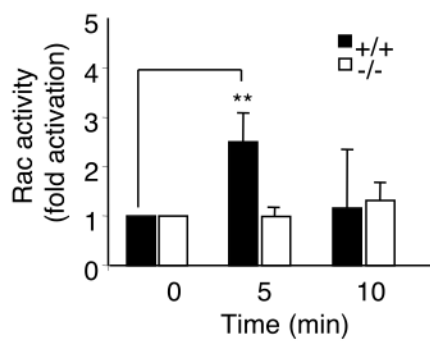
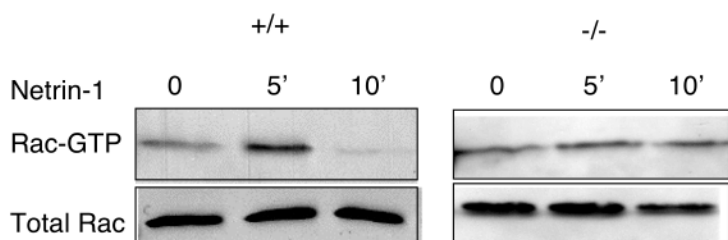

**B**

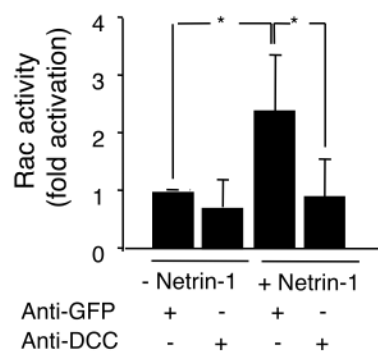
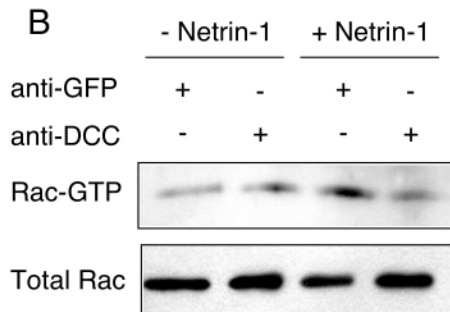

**A**

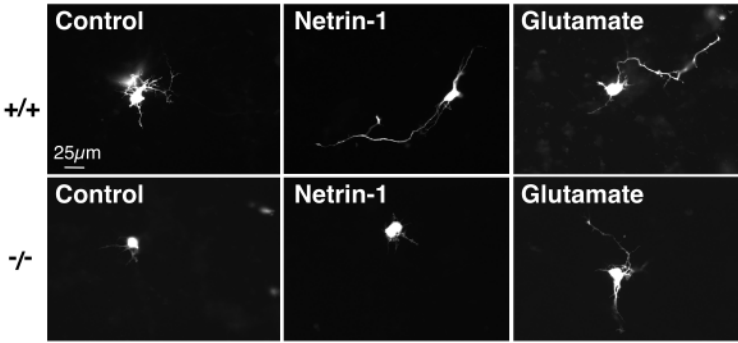

**B**

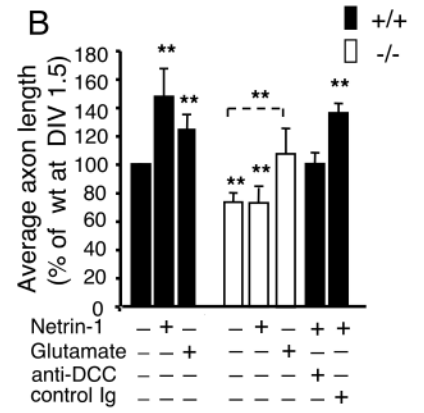

**C**

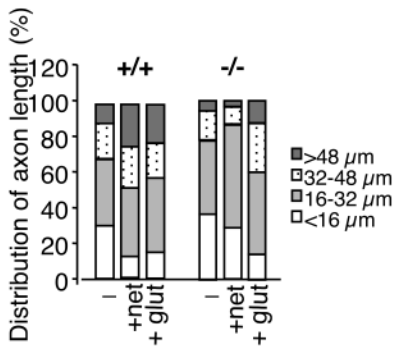

**D**

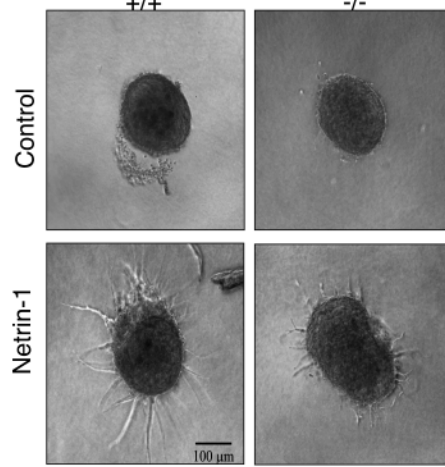

**E**

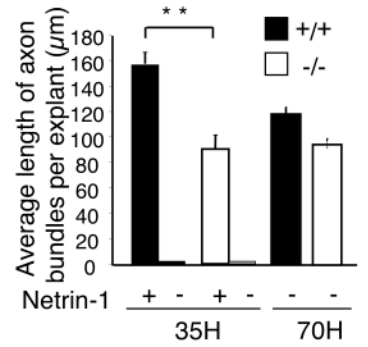

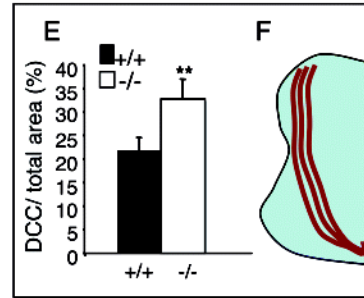
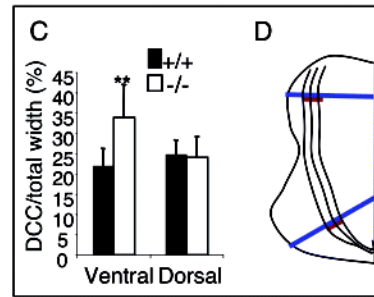
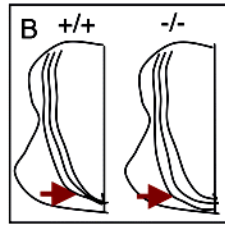
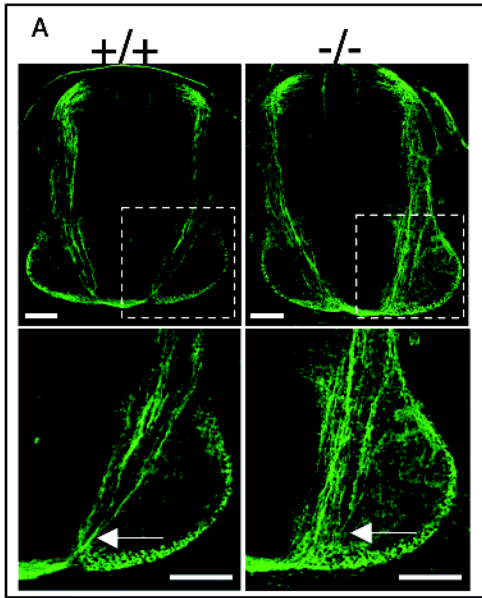



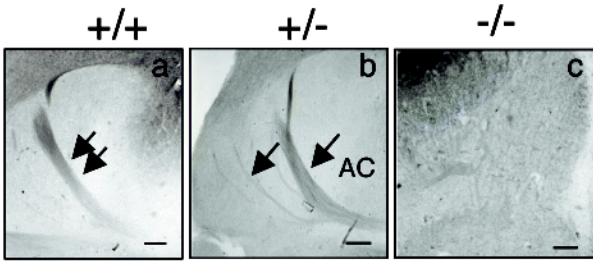



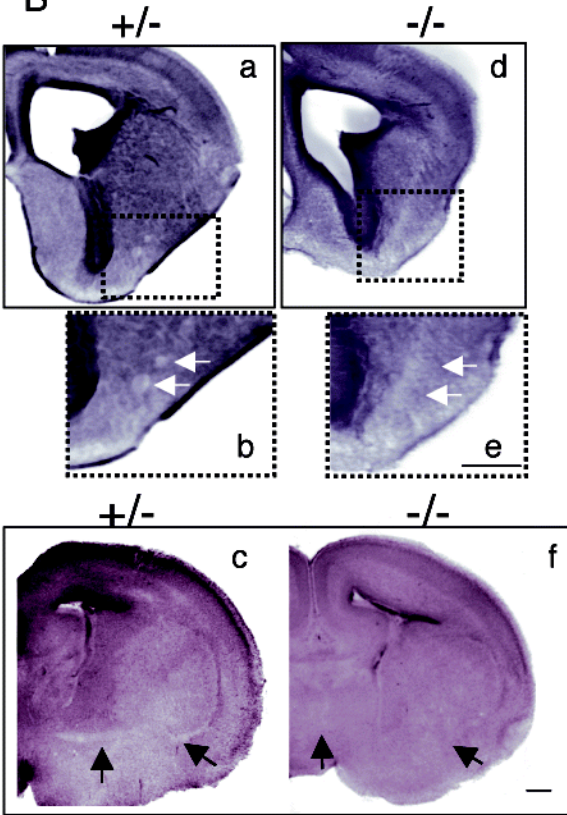

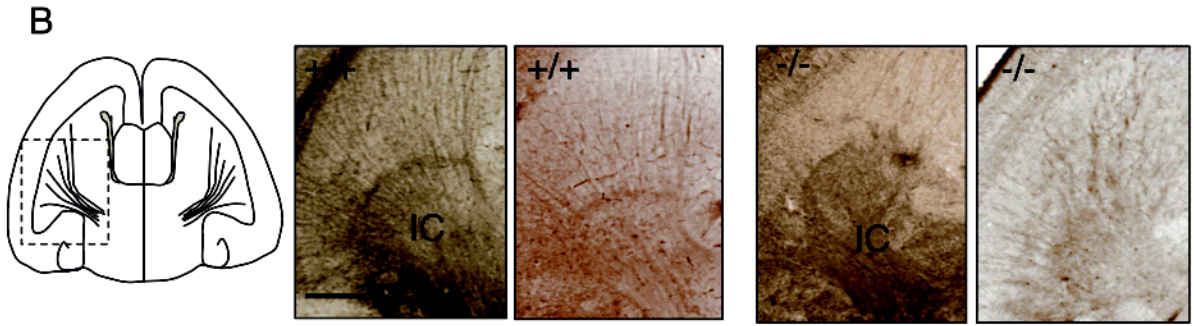
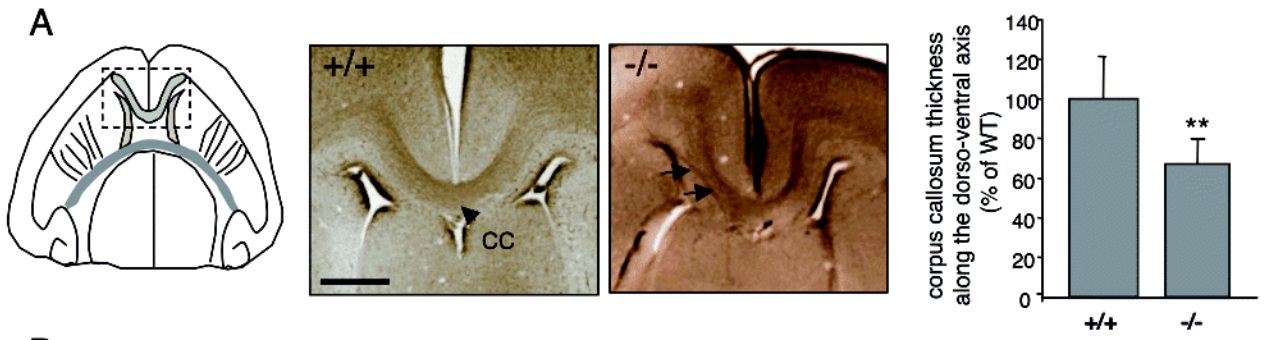



A



B





	WT	Trio mutant	Netrin/DCC mutants
Spinal commissural axon projections		Defasciculated 	Absent 
Anterior commissure		Defasciculated in Trio -/+ Absent in Trio -/- 	Absent or severely reduced 
Corpus callosum		Reduced (30%) with some aberrant bundles 	Absent 
Internal capsule		Disorganized 	Disorganized and reduced 