

Particles in Turbulence

Preliminary results from Lagrangian Acoustic Velocimetry

M. Bourgoin,

P. N. Qureshi, A. Cartellier, Y. Gagne, C. Baudet,



Inertial particles in turbulence

- effect of particles finite size ?
- effect of particle to fluid density ratio ?
- effect of particles concentration (collective effects) ?

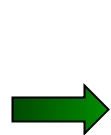

Preferential concentration - Clustering
Enhancement of settling velocity
Dispersion
...

Lagrangian measurements :
to characterize particles dynamics at large and small scales

Outline

- Acoustic velocimetry technique
 - principle of Acoustic Doppler velocimetry
 - data acquisition and processing
- « Inertial » particles dynamics (preliminary)
 - wind tunnel measurements
 - finite size effects on velocity increments statistics

Acoustic velocimetry principle

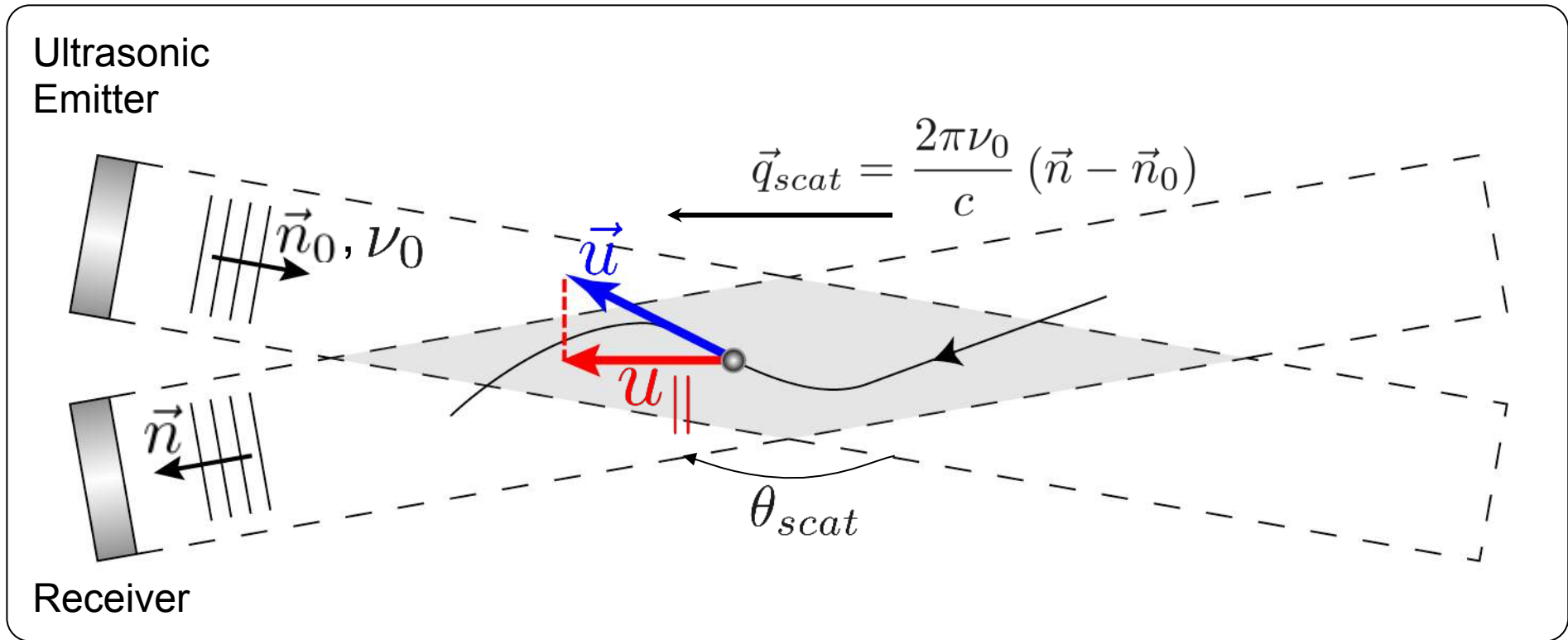

Scattering vector :
$$\vec{q}_{scat} = \frac{2\pi\nu_0}{c} (\vec{n} - \vec{n}_0)$$

Doppler shift :
$$\delta\nu(t) = \nu(t) - \nu_0 = \frac{1}{2\pi} \vec{q}_{scat} \cdot \vec{u}(t) = u_{||}(t) \frac{2\nu_0 \sin\left(\frac{\theta}{2}\right)}{c}$$

$$u_{||}(t) = \frac{c}{2\nu_0 \sin\left(\frac{\theta_{scat}}{2}\right)} \delta\nu(t)$$

Acoustic velocimetry principle

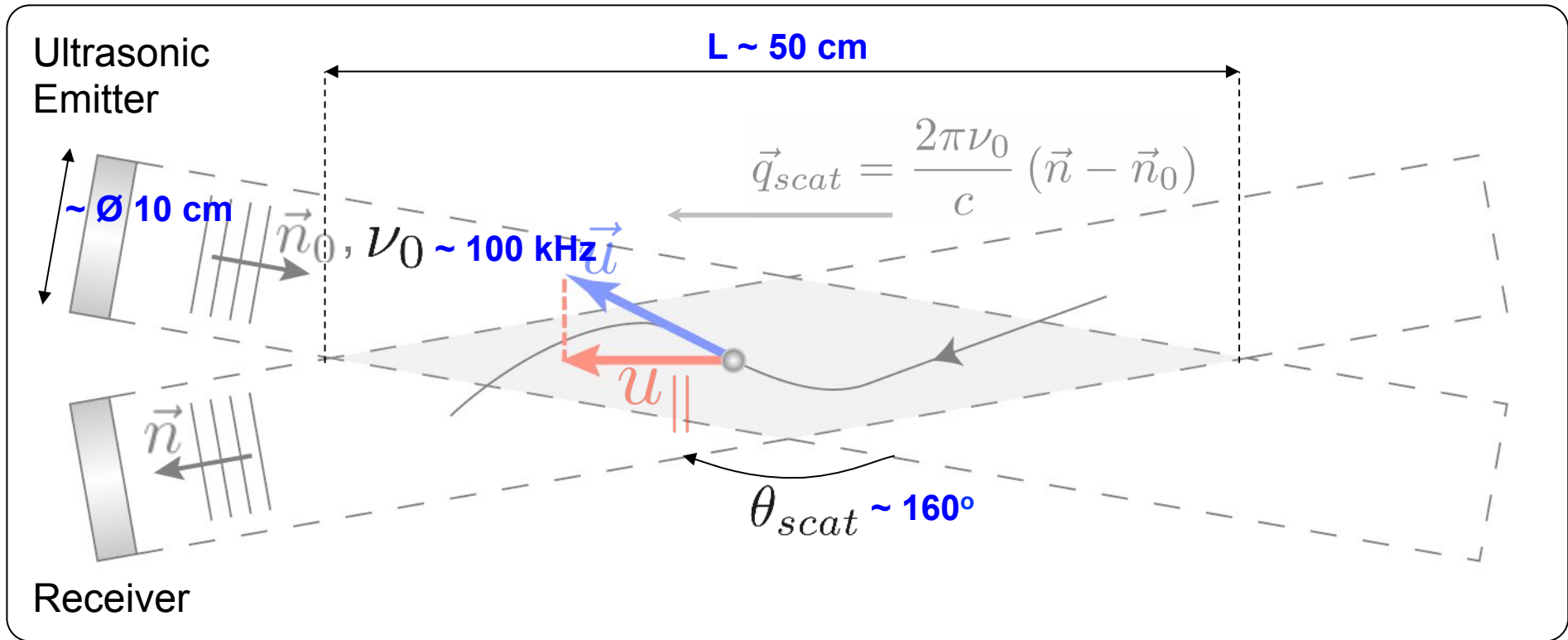

Scattering vector :
$$\vec{q}_{scat} = \frac{2\pi\nu_0}{c} (\vec{n} - \vec{n}_0)$$

Doppler shift :
$$\delta\nu(t) = \nu(t) - \nu_0 = \frac{1}{2\pi} \vec{q}_{scat} \cdot \vec{u}(t) = u_{||}(t) \frac{2\nu_0 \sin\left(\frac{\theta}{2}\right)}{c}$$

$$u_{||}(t) = \frac{c}{2\nu_0 \sin\left(\frac{\theta_{scat}}{2}\right)} \delta\nu(t)$$

3D Acoustic velocimetry

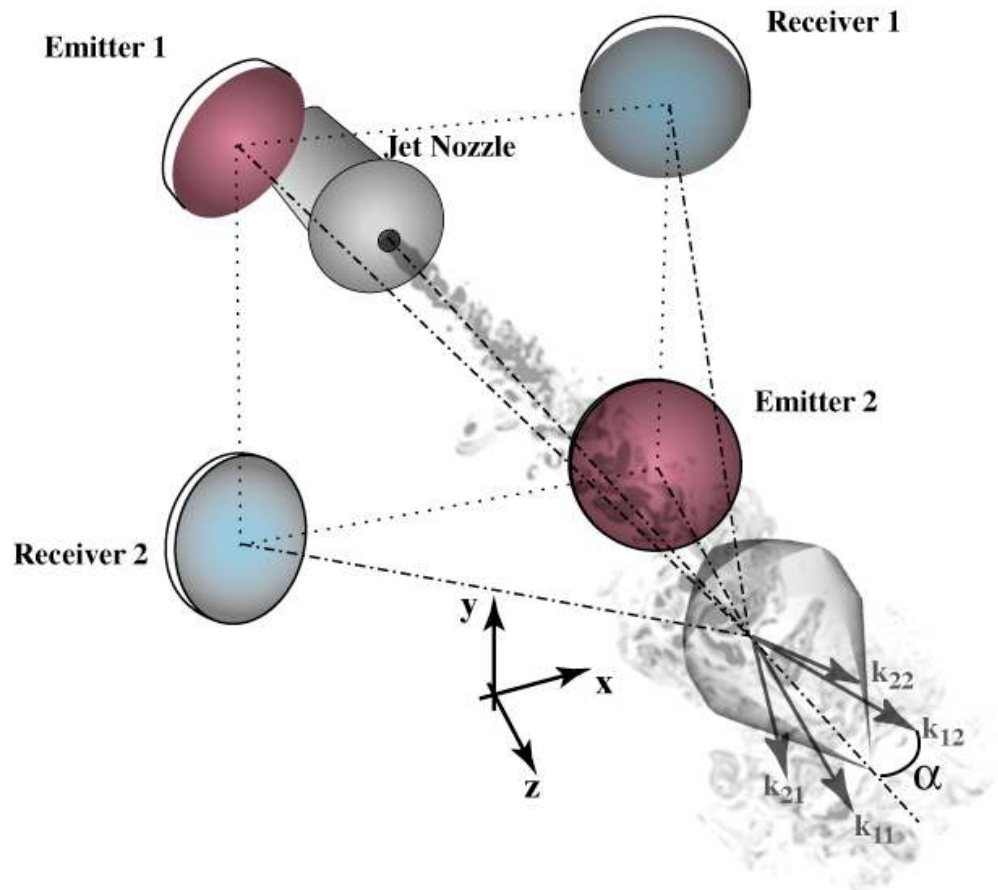

- 4 independent projections

$$u = \frac{v_{11} + v_{12} + v_{21} + v_{22}}{4 \cos \alpha}$$

$$v = \frac{v_{12} - v_{21}}{2 \sin \alpha} \quad w = \frac{v_{22} - v_{11}}{2 \sin \alpha}$$

- Better SNR

- Well adapted for measurements in open flows with a (large) mean velocity

- Possibility for simultaneous Eulerian measurements (hot wire)

Particles : Gas filled soap bubbles

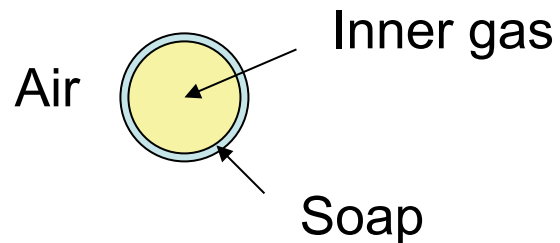

Using **Helium** as inner gas,
we can compensate the weight of soap

➔ **Neutrally buoyant particles**

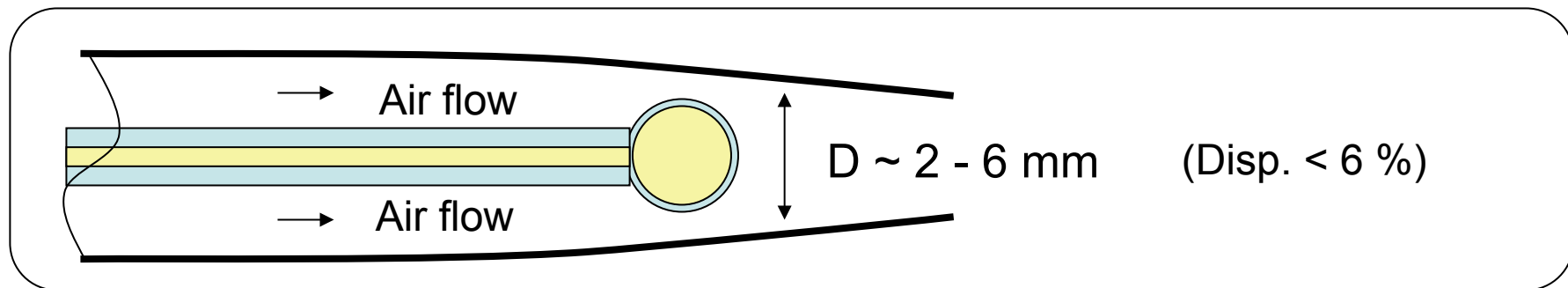

● Adjustable parameters :

- soap, gas and air flow rates
- inner gas type



Bubbles density, size and production rate adjustable

Stokes number effects : *Lagrangian tracers* ➔ *inertial particles*

Data Acquisition - Processing

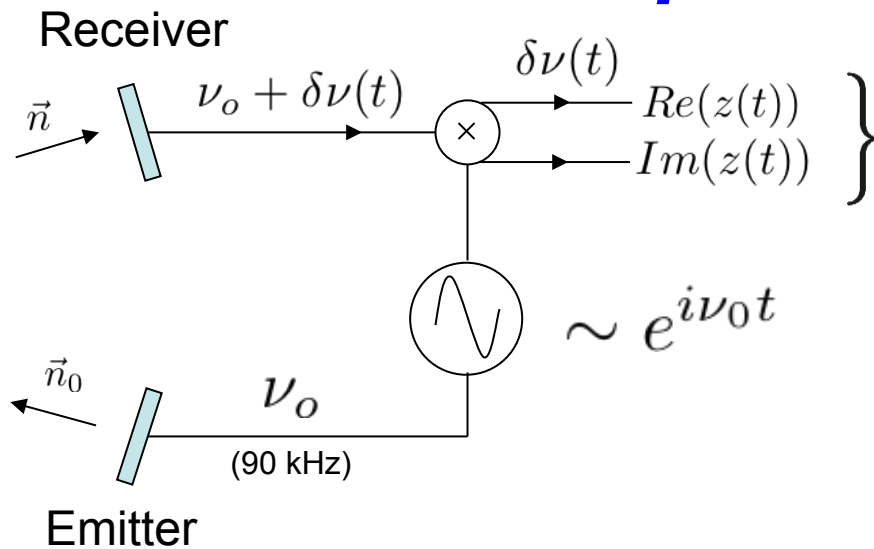

$$z(t) = A(t) e^{i \int_0^t \delta \nu(t') dt'}$$

Complex downmixed signal

Time-frequency analysis

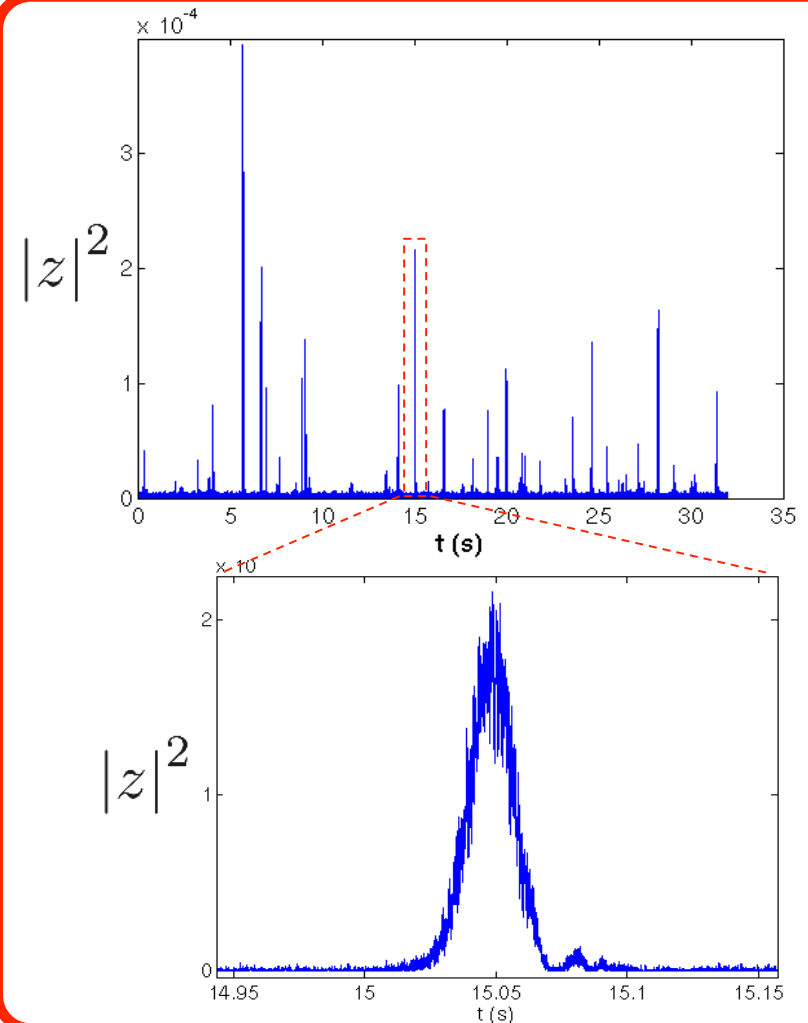
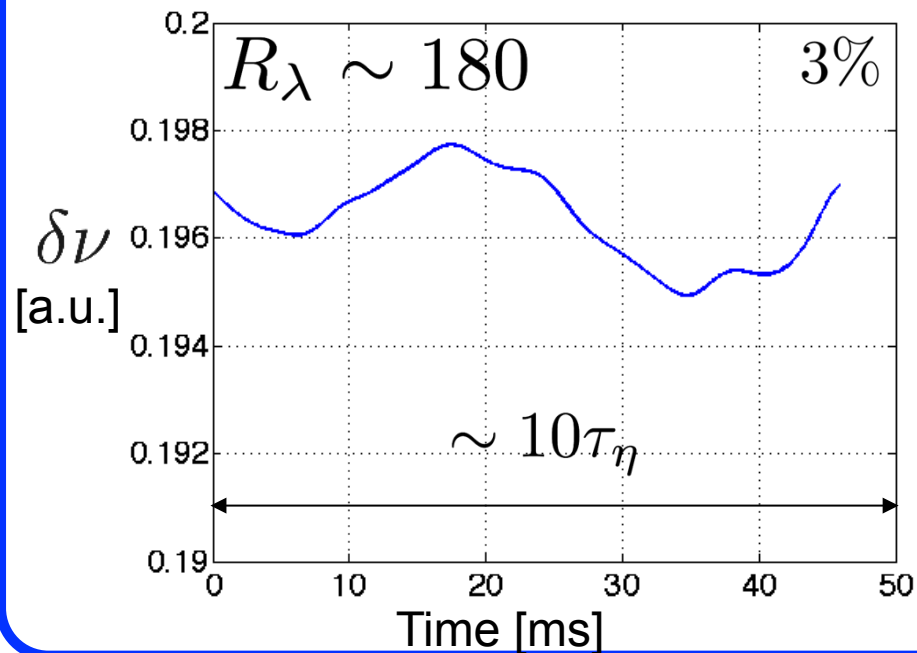

Inertial particles

- effect of particles finite size ?
- effect of particle to fluid density ratio ?
- effect of particles concentration (collective effects) ?

- Wind tunnel grid turbulence

$$R_\lambda \sim 180 \quad - \quad 3\%$$

$$\eta \sim 200 \mu\text{m}$$
$$L \sim 6 \text{ cm}$$

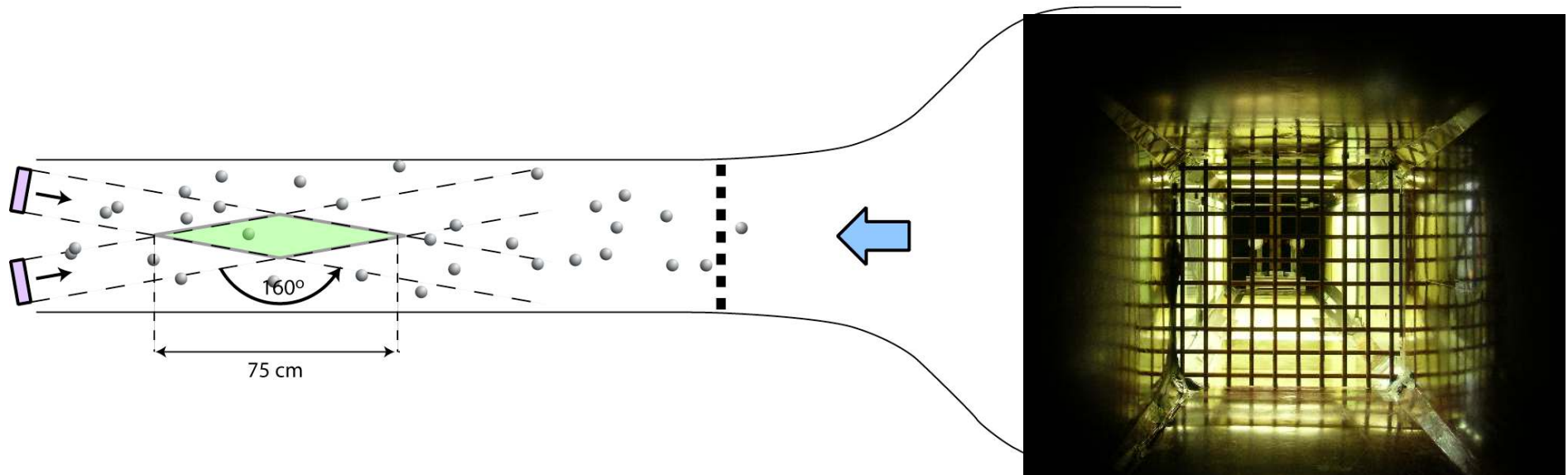

Inertial particles

- effect of particles finite size ?
- effect of particle to fluid density ratio ?
- effect of particles concentration (collective effects) ?

- Wind tunnel grid turbulence

$$R_\lambda \sim 180 \quad \text{---} \quad 3\%$$

$$\eta \sim 200 \mu\text{m}$$
$$L \sim 6 \text{ cm}$$

- isolated neutrally buoyant particles

$$D = 2 \text{ mm} \quad \text{---} \quad 6 \text{ mm}$$
$$\sim 10\eta \quad \text{---} \quad 30\eta$$

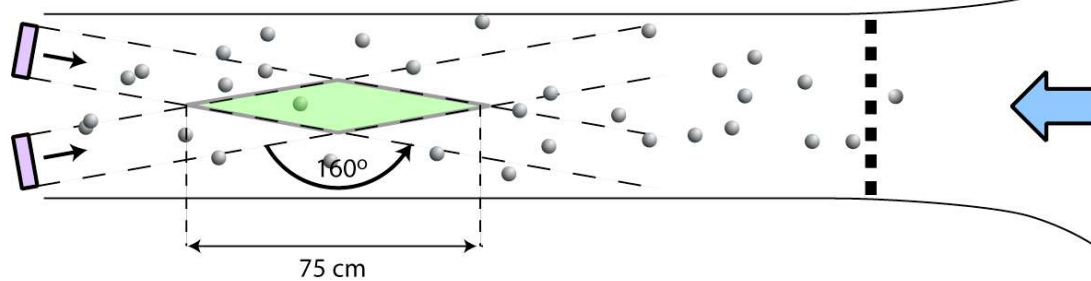

Lagrangian velocity Increments statistics

$$\delta_\tau v(t) = v(t + \tau) - v(t)$$

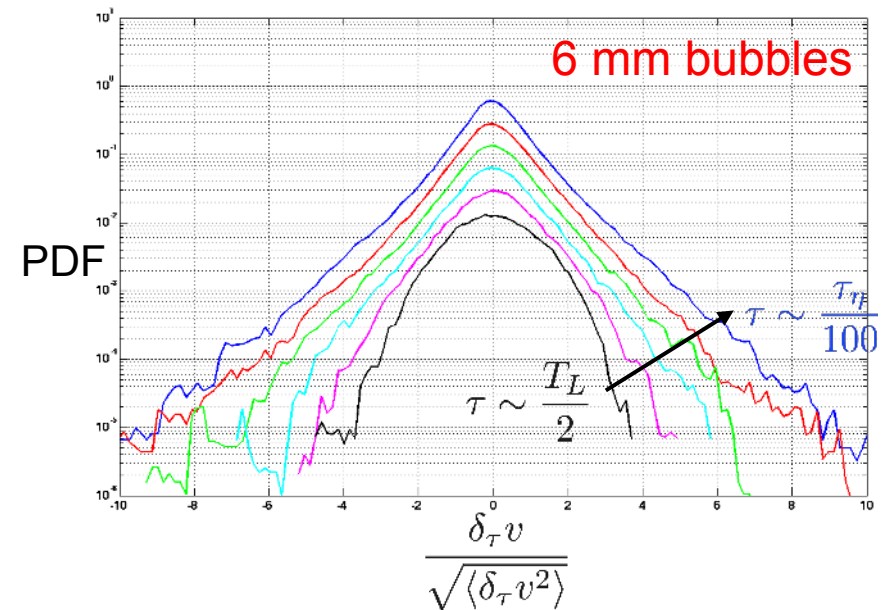
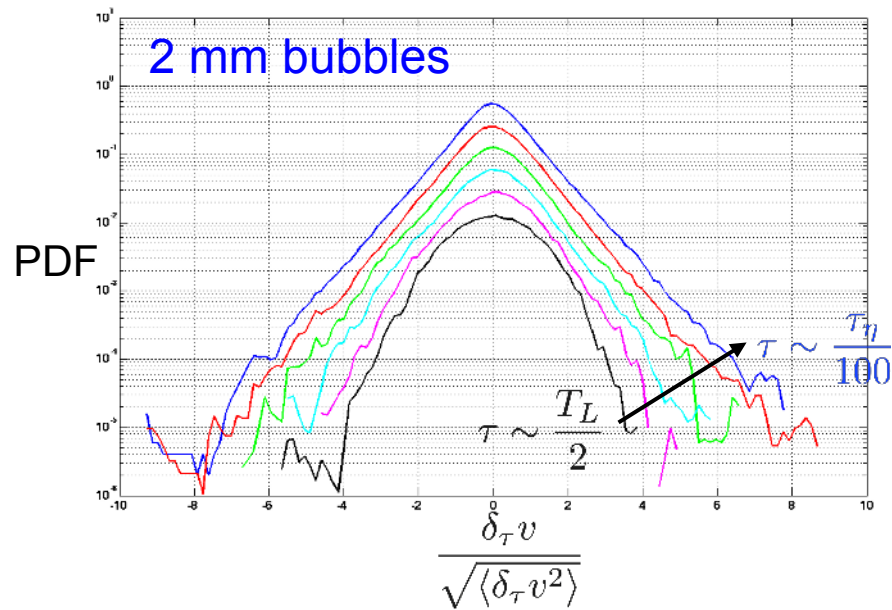

Lagrangian velocity Increments statistics

$$\delta_\tau v(t) = v(t + \tau) - v(t)$$

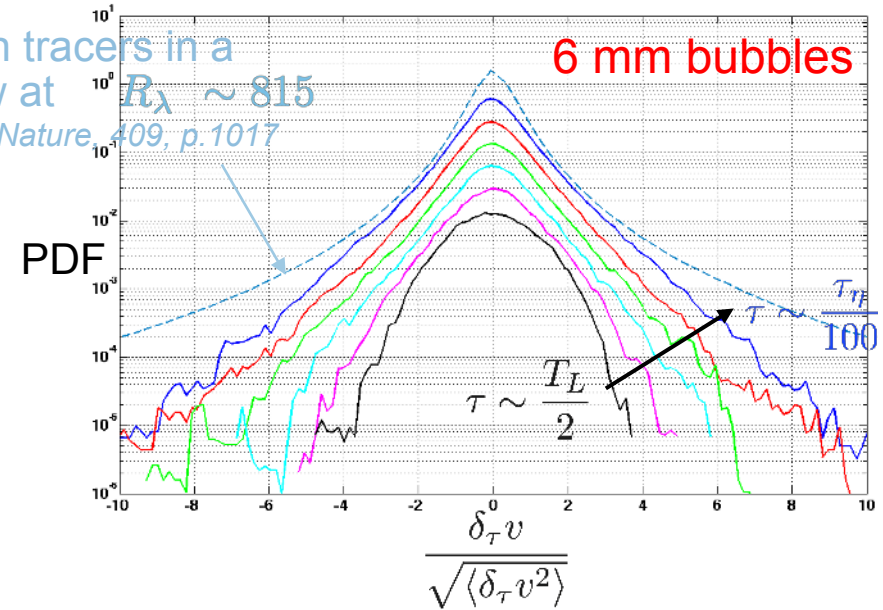
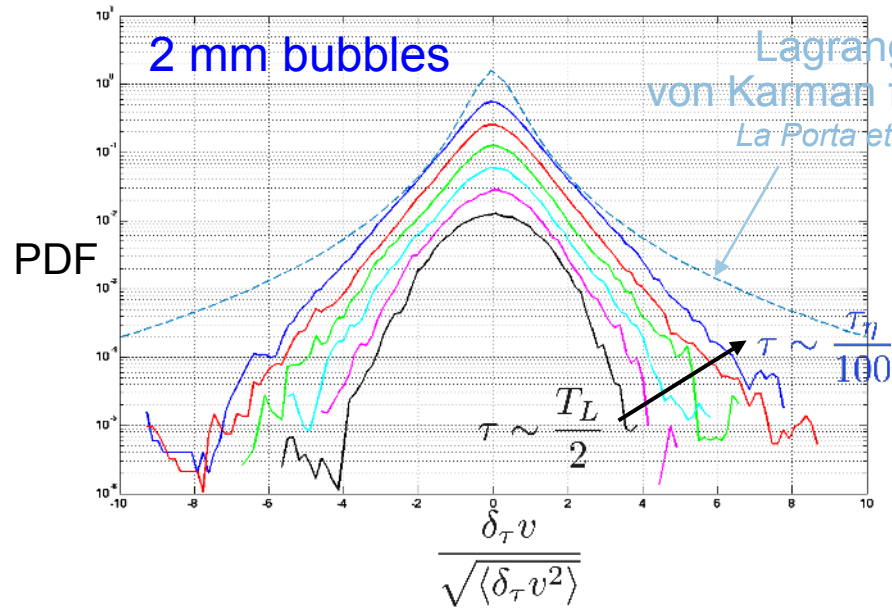

Lagrangian velocity Increments statistics

$$\delta_\tau v(t) = v(t + \tau) - v(t)$$

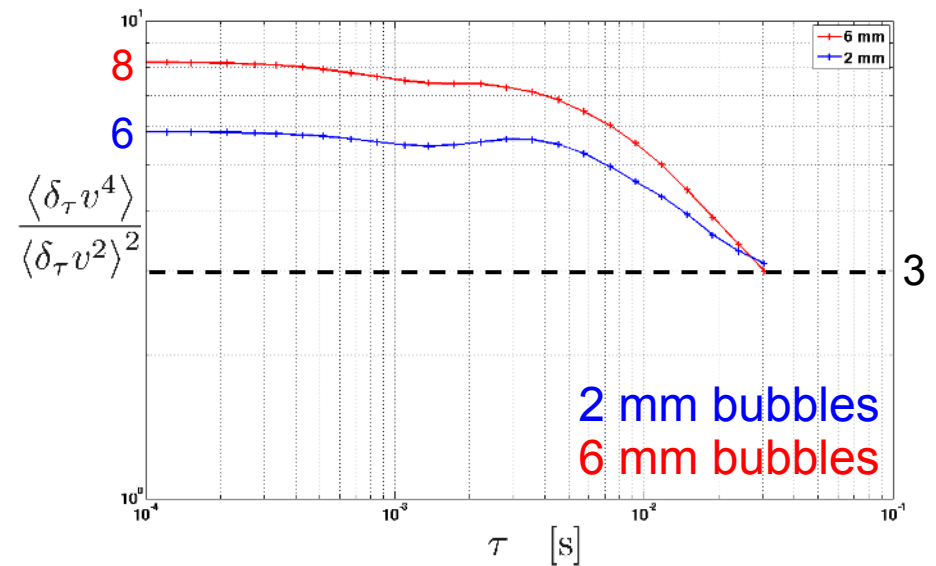
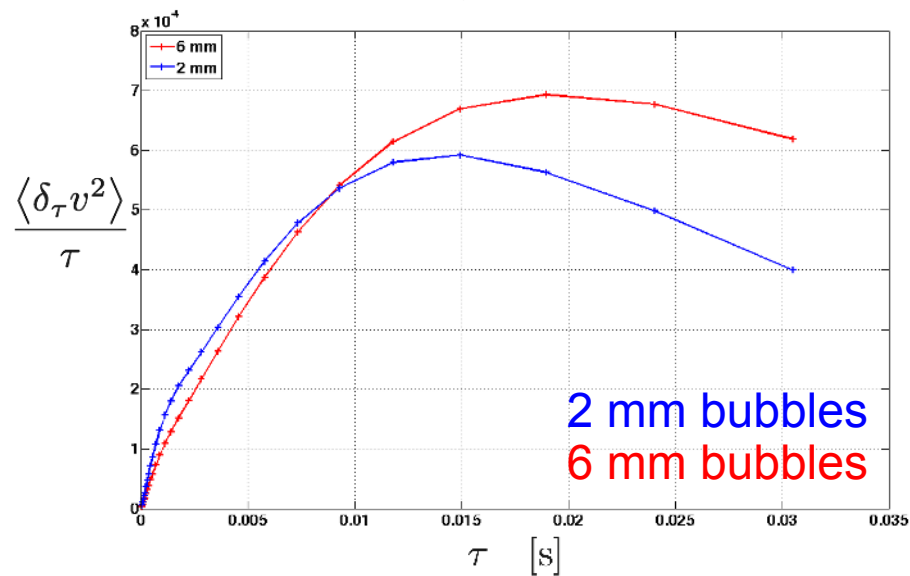
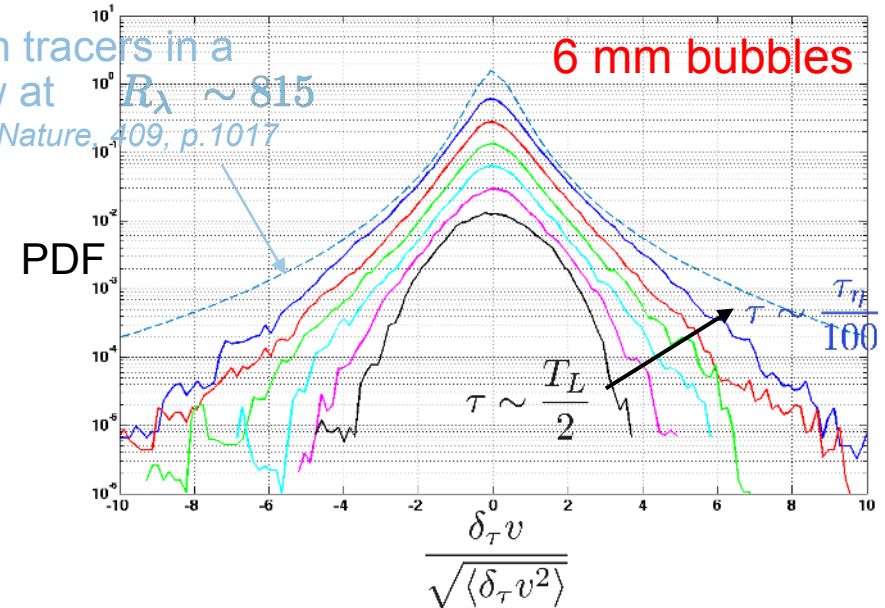
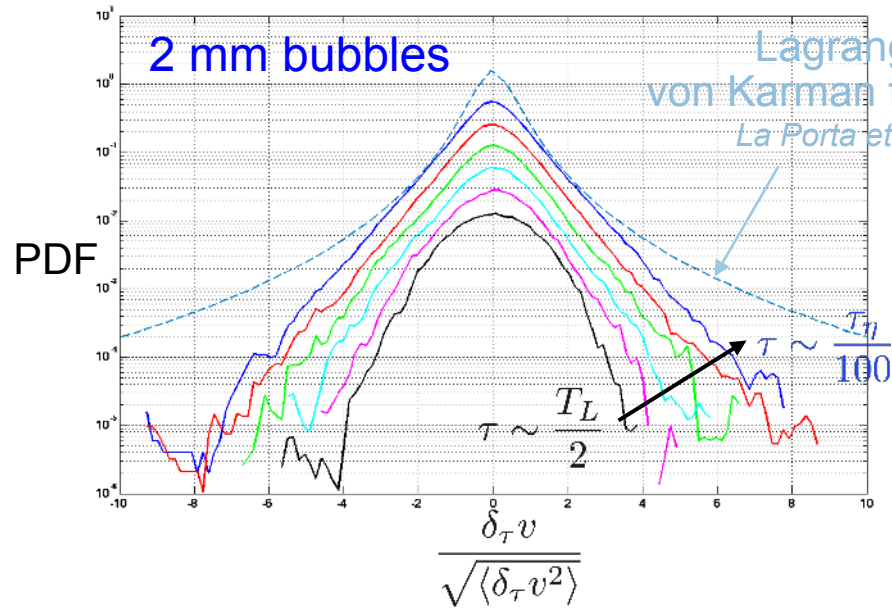

Non-normalized acceleration PDFs

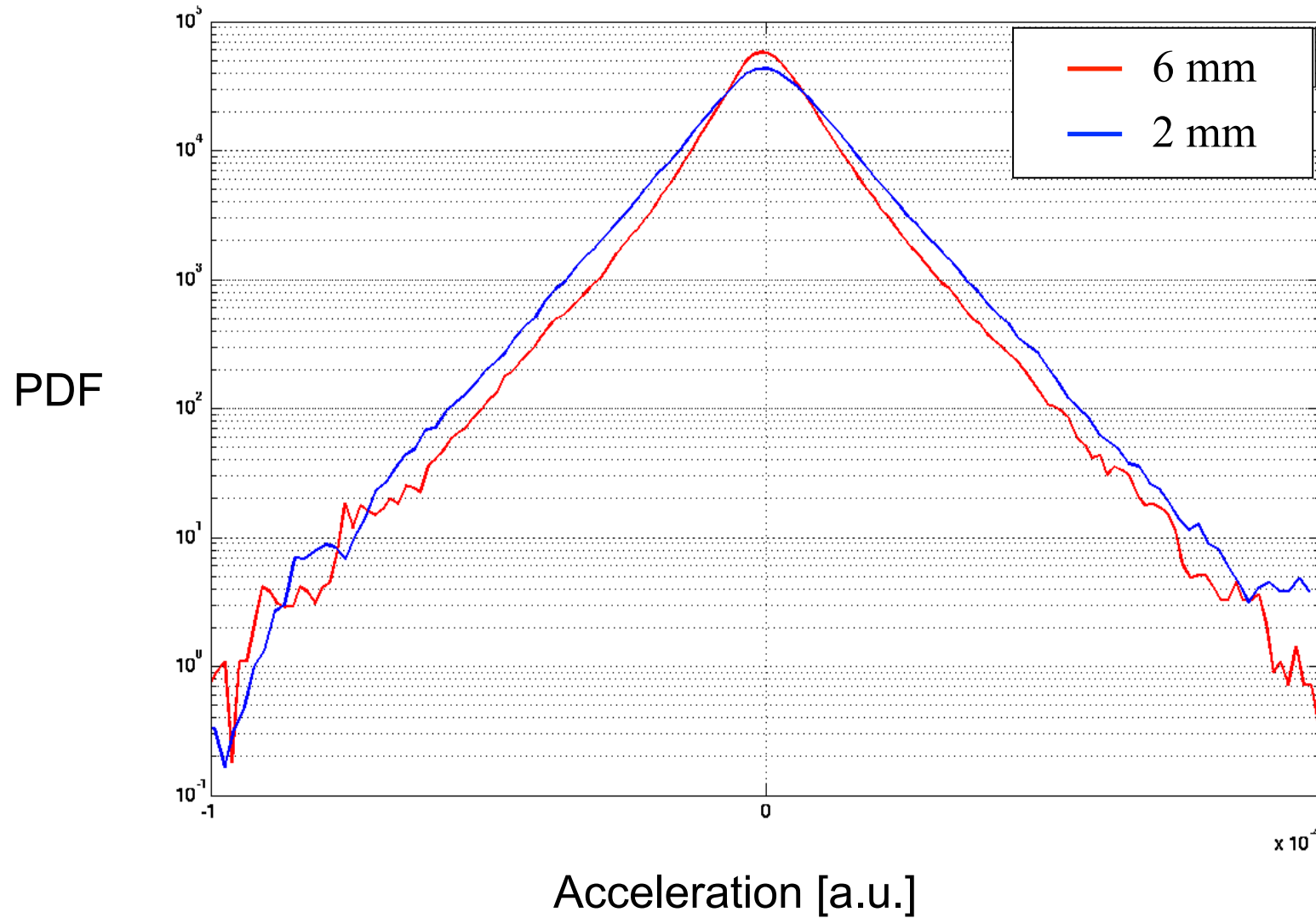

Conclusions

- Acoustic Lagrangian Velocimetry technique (3D)
 - Well suited for individual particle tracking in open flows
 - Possibility of simultaneous Eulerian measurements
- Tracking of soap bubbles inflated with gas
 - density and size easily adjustable
- Size effects on large neutrally buoyant isolated particles (preliminary)
 - Intermittency - weaker than for fluid tracers
 - Smaller bubbles have larger acceleration variance
 - Surprisingly, we find a larger acceleration flatness for the larger bubbles
- Perspectives
 - repeat the measurements for other sizes of bubbles
 - heavy particles dynamics
 - Clustering-Collective effects (many particles)

Ultrasonic transducers

Sell-type transducers (*electro-acoustical circular piston*)

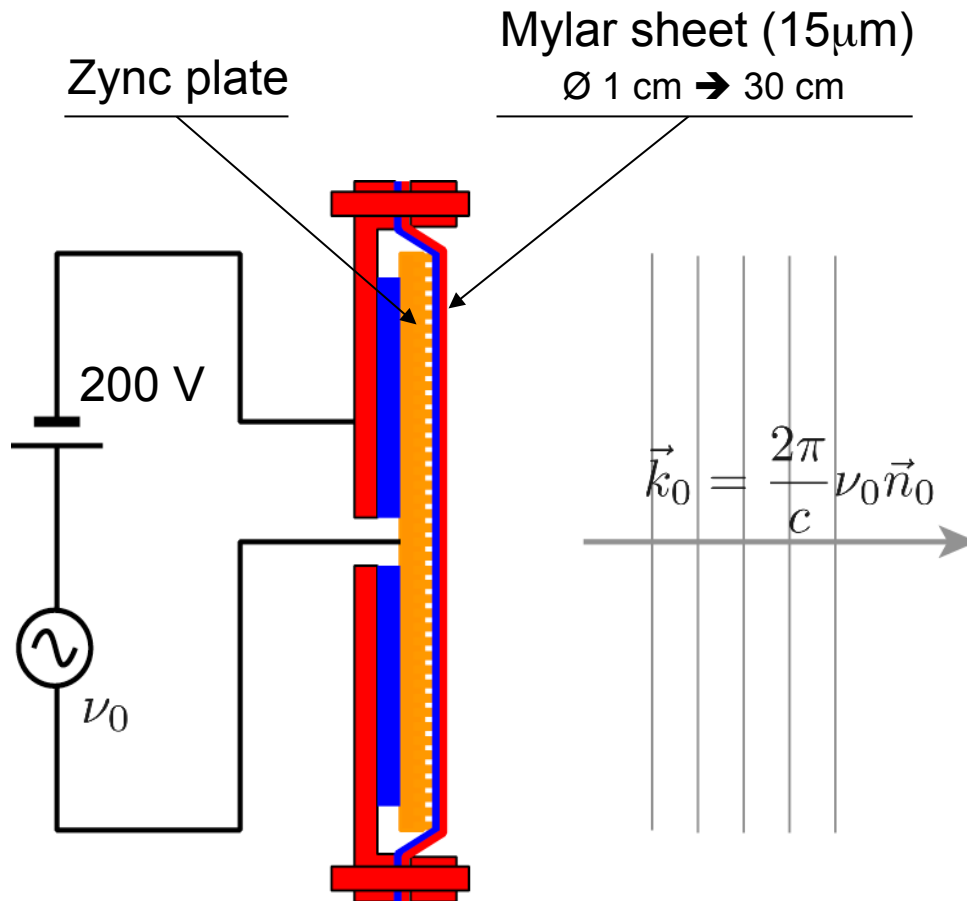

- Reciprocal
- Linear
- Large spectral band width (20kHz \rightarrow 150 kHz)
- Directional
- Home made

Data Acquisition - Processing

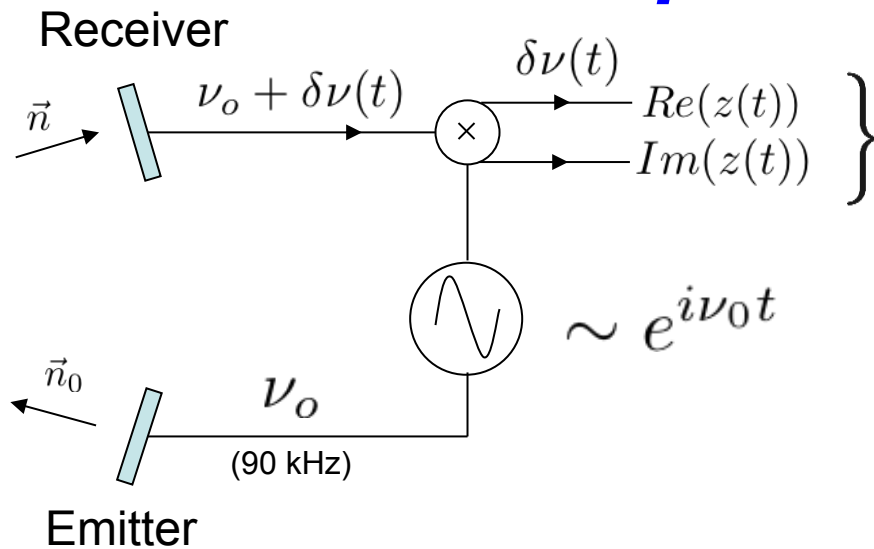

$$z(t) = A(t)e^{i2\pi \int_0^t \delta\nu(t') dt'}$$

Complex downmixed signal

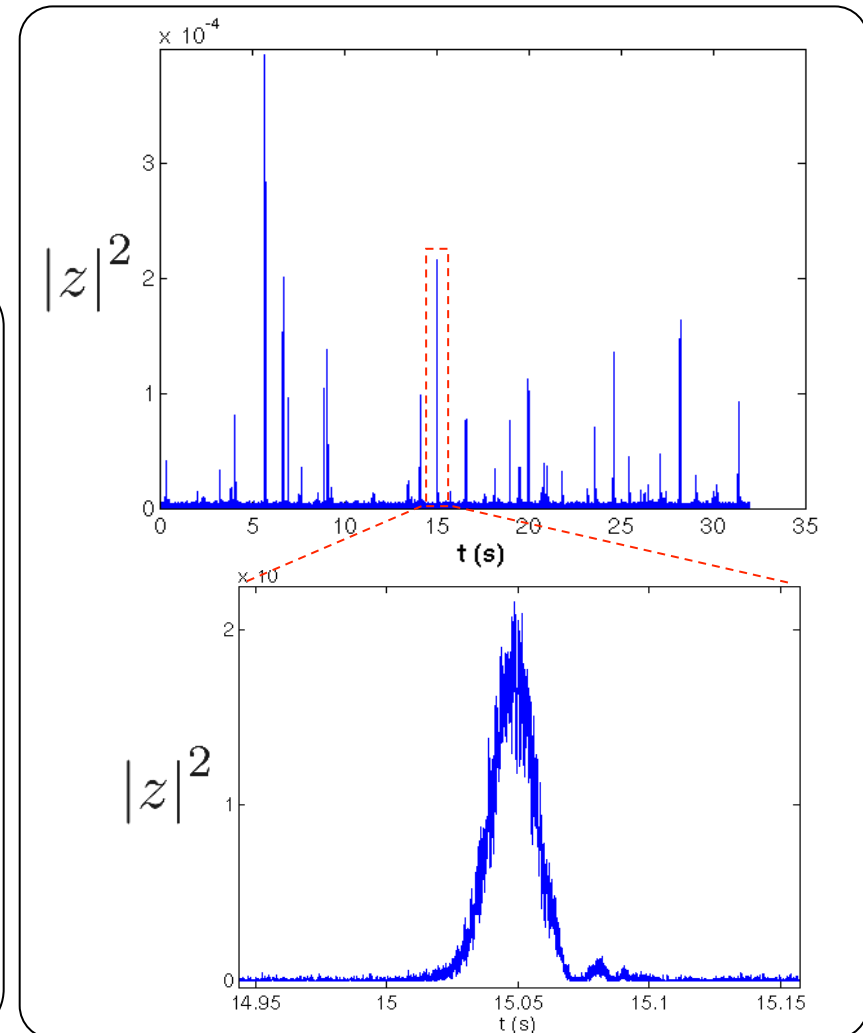
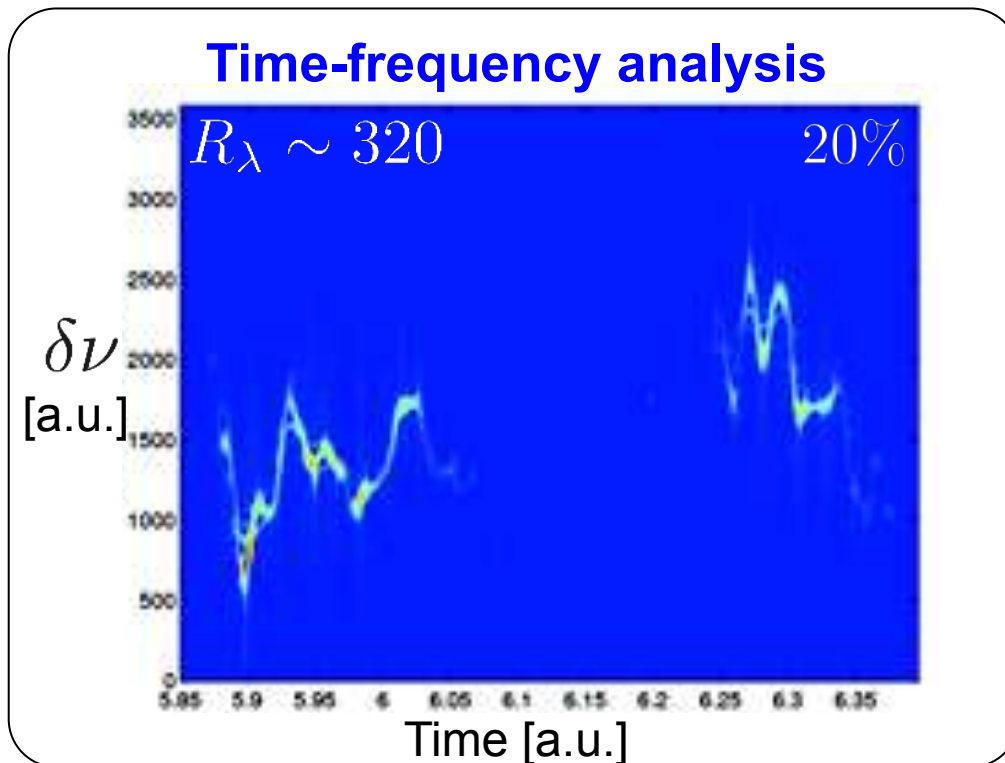

Data Acquisition - Processing

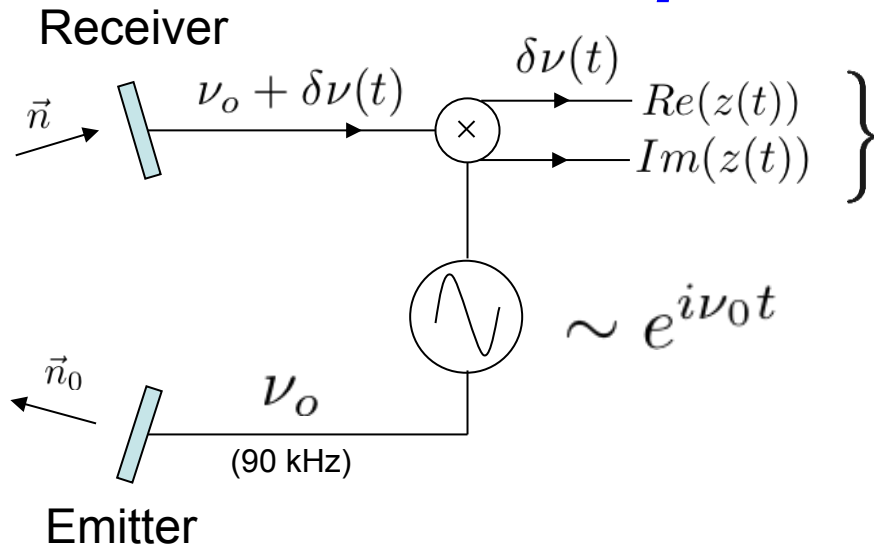

$$z(t) = A(t)e^{i2\pi \int_0^t \delta\nu(t') dt'}$$

Complex downmixed signal

$$z(t) = A_1(t)e^{i2\pi \int_0^t \delta\nu_1(t') dt'} + A_2(t)e^{i2\pi \int_0^t \delta\nu_2(t') dt'}$$

$$|z|^2 = |A_1|^2 + |A_2|^2 + 2A_1A_2 \cos\left(i2\pi \int_0^t \delta\nu_1(t') - \delta\nu_2(t') dt'\right)$$

