



HAL
open science

Scale effects on Hydrodynamics and Heat Transfer in two-dimensional mini and microchannels

Puzhen Gao, Stéphane Le Person, Michel Favre-Marinet

► **To cite this version:**

Puzhen Gao, Stéphane Le Person, Michel Favre-Marinet. Scale effects on Hydrodynamics and Heat Transfer in two-dimensional mini and microchannels. *International Journal of Thermal Sciences*, 2002, 41 (11), pp.1017-1027. 10.1016/S1290-0729(02)01389-3 . hal-00204622

HAL Id: hal-00204622

<https://hal.science/hal-00204622v1>

Submitted on 18 Feb 2020

HAL is a multi-disciplinary open access archive for the deposit and dissemination of scientific research documents, whether they are published or not. The documents may come from teaching and research institutions in France or abroad, or from public or private research centers.

L'archive ouverte pluridisciplinaire **HAL**, est destinée au dépôt et à la diffusion de documents scientifiques de niveau recherche, publiés ou non, émanant des établissements d'enseignement et de recherche français ou étrangers, des laboratoires publics ou privés.



Distributed under a Creative Commons Attribution 4.0 International License

Scale effects on hydrodynamics and heat transfer in two-dimensional mini and microchannels

Puzhen Gao ^{a,1}, Stéphane Le Person ^a, Michel Favre-Marinet ^{a,*}

^a *Laboratoire des écoulements géophysiques et industriels CNRS-UJF-INPG, 1025, rue de la Piscine, BP 53 X, 38041, Grenoble cedex, France*

The present paper is devoted to experimental investigations of the flow and the associated heat transfer in two-dimensional microchannels. Scaling laws pertaining to the hydrodynamics and heat transfer in microchannels are not yet clearly established. The published results are affected by a significant scatter, owing to the various conditions used in the experiments, and, most likely, owing to the difficulty of measurements at micronic scales. The present facility was designed to modify easily the channel height e . It was then possible to investigate hydrodynamics and heat transfer in channels of height ranging from 1 mm, which corresponds to conventional size, up to 0.1 mm, where size effects are expected. Size effects were therefore tested in the same set-up and with the same channel walls for all the experiments, which were carried out with demineralized water. Measurements of the overall friction coefficient and of local Nusselt numbers show that the classical laws of hydrodynamics and heat transfer are verified for $e > 0.4$ mm. For lower values of e , a significant decrease of the Nusselt number is observed whereas the Poiseuille number keeps the conventional value of laminar developed flow. The transition to turbulence is not affected by the channel size.

Keywords: Microfluidics; Micro heat transfer; Channel flow; Smooth walls; Laminar flow; Turbulent flow

1. Introduction

The current technological advances enable the development of ever more miniaturized systems, which opens a large field of applications in the medical domain (for example, development of integrated Micro Analysing Systems [1]) or in the field of the engineering sciences. Concerning heat transfer, micro heat exchangers are very promising for applications to the computer industry, which more and more needs efficient devices for cooling electronic equipment. In fact, several studies conducted during the last decade have shown the strong interest to use mini-channels (characteristic dimension $d \approx 1$ mm) or microchannels (d varying from several microns to several hundred of microns) for cooling efficiently electronic components [2,3]. On the same way, heat removal is a limiting factor for power electronics and inte-

grated systems using microchannels etched in silicon wafers have proved their efficiency for cooling electric power components [4].

Researches on micro-systems rise difficult technological problems for the manufacturing processes and for instrumentation, and more fundamental questions linked to the very small scales involved in the physical phenomena. Only this latter aspect concerns the present paper.

Many studies of the last ten years are relevant to hydrodynamics and heat transfer for single-phase flows in microchannels. They have revealed important differences with the classical laws, which are well established for geometrical configurations of usual size. However, some of the published results on this subject present contradictory conclusions. Actually, scaling laws pertaining to the hydrodynamics and heat transfer in microchannels are not clearly established.

The objective of the present study was to investigate the hydrodynamics and heat transfer in microchannels in a well-controlled experiment. The issue concerns the applicability of the classical laws (friction factor, laminar-turbulent transition, heat exchange coefficient) when the characteristic dimensions of the channel are of the order of several hundred

* Corresponding author.

E-mail address: michel.favre-marinet@hmg.inpg.fr

(M. Favre-Marinet).

¹ Presently at Harbin Engineering University, Yiman Street, Harbin, Heilongjiang province, People's Republic of China

Nomenclature

a	distance between the channel wall and the heating resistances	m
b	channel width (spanwise direction)	m
C_p	specific heat capacity	J·kg ⁻¹ ·K ⁻¹
D_h	hydraulic diameter	m
e	channel height	m
f	Fanning friction factor	
h	heat transfer coefficient	W·m ⁻² ·K ⁻¹
k	thermal conductivity	W·m ⁻¹ ·K ⁻¹
L	channel length	m
L^+	$= \frac{L}{D_h} \frac{1}{Re}$, non-dimensional channel length	
l_h	heating resistance length	m
Nu	Nusselt number	
P	electric power	W
p	pressure	Pa
Po	Poiseuille number	
Pr	Prandtl number	
Q	volumetric flow rate	l·min ⁻¹
Re	Reynolds number	
T	temperature	°C
V	channel bulk velocity	m·s ⁻¹
x	abscissa along the channel	m

$$x^* = \frac{x}{D_h} \frac{1}{RePr} \text{ entrance region parameter}$$

Greek letters

φ	heat flux	W·m ⁻²
Φ_e	total heat transfer rate	W
μ	dynamic viscosity	kg·m ⁻¹ ·s ⁻¹
ρ	density	m ³ ·s ⁻¹
τ	wall shear stress	N·m ²

Subscripts

av	average
c	critical
exp	experimental
f	fluid
film	film (Eq. (2))
hyd	hydraulic
in	inlet
lam	laminar
mod	modelled
out	outlet
th	theoretical
tr	transition
w	wall

to one hundred microns. The microchannels used during the experiments were two-dimensional to avoid the influence of more complex geometrical configurations.

2. Scientific background

Tuckermann and Pease [5,6] were the first to underline the interest of using very small channels for cooling electronic chips. Since this initial work, several authors [7–11] noticed an enhancement of heat transfer in microchannels in comparison with the results obtained for heat exchangers of conventional size. Other differences with the classical laws are observed for these micronic scales. In the laminar regime, Wang and Peng [8] have found that the Nusselt number (Nu) increases with the Reynolds number (Re) while the conventional theory indicates that Nu remains constant and independent of Re for laminar developed channel flow. On the other hand, in the turbulent regime, the same authors have found that Nu is significantly reduced (by a factor about 3), in comparison with classical laws.

Various studies conducted on the hydrodynamics in microchannels show that the transition to turbulence occurs for lower Reynolds number (for example, for $400 < Re < 700$, [12]) than in channels of conventional size.

Recent publications show contradictory conclusions on the friction coefficient f . In the laminar regime, Pfahler et al. [13] and Duncan and Peterson [14] noticed a decrease of f from 20 to 40%. Flockhart and Dhariwal [2] found no

scale effects on hydraulics in trapezoidal channels etched in silicon wafers (27 or 63 microns in height, Reynolds number < 240). On the contrary, Qu et al. [15] observed significant increase of f in the same type of channels (height 28 to 111 microns) in all the range of Re investigated (until 1600). Even more contradictory results exist for the turbulent regime.

In spite of the scattering of the published results, it seems that size effects are present in the hydrodynamics and heat transfer in microchannels. However, the tendencies are not firmly established.

There has been no conclusive explanation of these observations up to now, although some physical phenomena have been referred to in the interpretation of these deviations from the hydrodynamics and heat transfer laws in large-scale ducts.

The analysis of the observed phenomena remains still open and the reasons of these modifications can be attributed to the complexity of the geometry of the studied channels or to the physical effects which become important at very small scales.

Wang and Peng [8] as well as Peng et al. [12] attributed the difference of behaviour in microchannels to a decrease of the viscosity consecutive to the significant increase of the fluid temperature. However, this variation of the fluid thermophysical properties seems to be too small for explaining the dependence and the growth of the Nusselt number with the Reynolds number in the laminar regime. Mala et al. [16] explained the decrease of the Nusselt number

by a local decrease of velocity due to the Electric Double Layer effect. However, the EDL theory gives a decrease of the Nu number of about 5 to 10%, which is far from the factor 3 observed by Wang and Peng [8]. In fact, the EDL effect is negligible when the channel thickness is higher than $40\ \mu\text{m}$ [17]. Capillarity effects or other physical factors of secondary importance in the conventional geometries were studied but cannot explain the deviations from classical laws. The wall roughness was considered by Sabry [18] as a possible factor to explain the observed results. Very recently, Qu et al. [19] developed a model to take this factor into account and found a good agreement with their own results.

At the present time, there is however no agreement about the possible phenomena involved in the physics of the flow in micro-channels. On the other hand, it may be underlined that the measurements are especially difficult owing to the very small scale of the test sections. It follows that the published results may be questionable in regard of the measurement accuracy. Further experiments are then clearly required to have better insight in the physics of these flows.

3. Experimental set-up and reduction of data

The experimental set-up was designed to investigate the single-phase flow and the associated heat transfer in channels of large-span rectangular cross-section and adjustable height in the range $[0.1\text{--}1\ \text{mm}]$. The fluid used was demineralized water of pH equal to 7.8. Water circulates in a closed-loop circuit (Fig. 1) which includes a pump (10 bars, $20\ \text{l}\cdot\text{mn}^{-1}$), a filter ($1\ \mu\text{m}$), two flowmeters (range: $0.25\ \text{l}\cdot\text{mn}^{-1}$, $6.3\ \text{l}\cdot\text{mn}^{-1}$), the test section, a heat exchanger

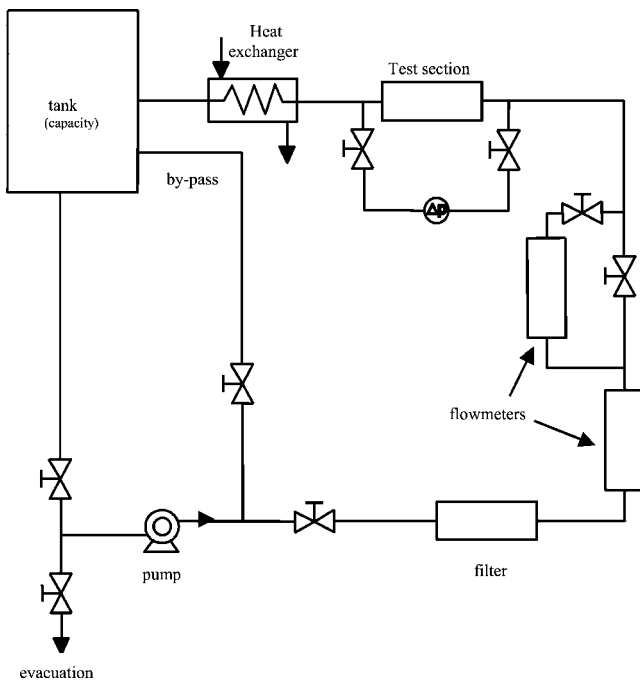

Fig. 1. Experimental set-up.

and a capacity of 30 l aimed at smoothing the fluid temperature variations.

The active channel walls are two plane brass blocks, which are separated by a foil (of thickness e) with a hollowed out central part of width b ($=25\ \text{mm}$) (Fig. 2). The thickness of this foil fixes the channel height e . A series of foils enables to change e by steps of $0.1\ \text{mm}$. The other dimensions of the channel are the width b and the length L ($=82\ \text{mm}$). The two blocks were rectified and hand-polished (measured roughness $<0.1\ \mu\text{m}$). Two sumps are machined in these blocks at channel inlet/outlet.

It is worth emphasising that there are two main advantages to this arrangement. The channel walls are the same surfaces during all the experiments. Also, for this two-dimensional configuration ($25 < b/e < 250$), experimental results are very simply compared to theory.

Heating of the fluid is provided by four electric cartridges (maximal total power of $4 \times 250\ \text{W}$), which are inserted inside the two blocks. Each heating block is mounted in a housing machined in a larger block of total thickness $30\ \text{mm}$ and surrounded by an insulating material (epoxy resin of thickness $5\ \text{mm}$). These two large blocks were fasten with bolts by using a torque spanner in order to have always the same force applied to the assembly. Watertightness is obtained by this tightening and by using a silicone grease between the foil and the surrounding blocks.

The inlet/outlet pressures of the test section are measured either by sensors Danfoss MBS 3000, 0–16 bars (accuracy: 1% of full scale range) or by a differential sensor HBW PD1/0.1 bar (accuracy: 1% of full scale range). The pressure sensors are placed flushed to the wall of the inlet/outlet sumps. The differential sensor is connected to the inlet/outlet tubes of the test section. The inlet/outlet fluid

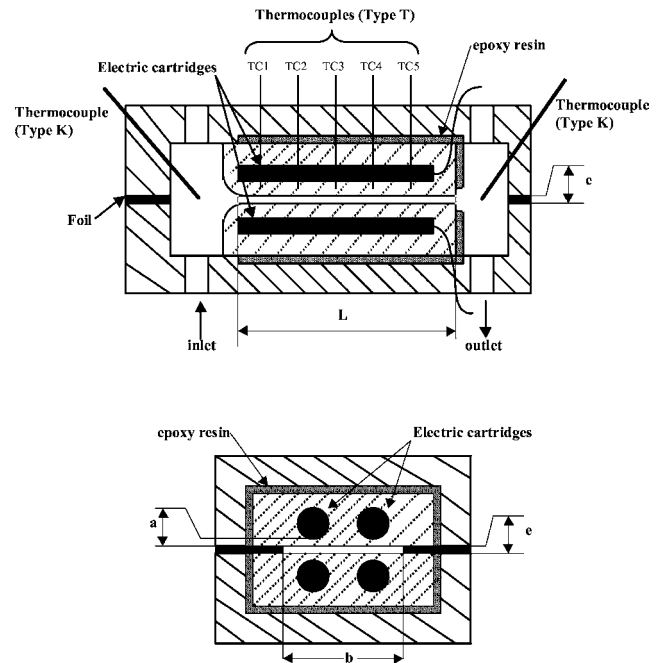

Fig. 2. Sketch of the test section.

temperatures are measured by thermocouples of type K (diameter = 3 mm) placed in the two sumps. The brass blocks are equipped with five thermocouples of type T (diameter = 0.5 mm) placed every 1.5 cm apart (position of the first thermocouple $x = 0.6$ cm). These thermocouples are denoted TCi hereafter. The sensitive part of the thermocouples is located 1 mm away from the metal-fluid interface. They were calibrated with a cryostat with a resolution of 0.1 °C and an accuracy of ± 0.01 °C. Two flowmeters of high accuracy are used to measure the flowrate. Their range and accuracy are respectively (0.01–0.25 l·min⁻¹, 0.3% of full scale range) and (0.04 to 6.3 l·min⁻¹, 0.2–0.5% of full scale range). The signals from the different sensors were sampled by a data acquisition system KEITHLEY2700 and stored in a PC microcomputer. For given flowrate and heating conditions, acquisition was started when all the measured quantities were stable. During each run of 10 minutes, about 100 samples were obtained and averaged for each measured variable. The data were interpreted by using the Reynolds number Re and the Nusselt number Nu , which were defined with the hydraulic diameter D_h . In the present microchannels of very large span, D_h was very close to $2e$. Re was based on the bulk velocity in the channel. Details on the processing of data for computing Nu are given in Section 4.3.

The water properties, such as density, dynamic viscosity, Pr number, were determined at the average inlet/outlet temperature T_{av} .

$$T_{av} = \frac{T_{in} + T_{out}}{2} \quad (1)$$

Table 1
Uncertainty analysis for $100 < Re < 8000$

e (mm)		1	0.5	0.1
dRe/Re	Mini	0.4%	0.4%	0.4%
	Maxi	0.8%	0.7%	0.7%
dNu/Nu	Mini	0.6%	0.7%	0.4%
	Maxi	7.8%	4.9%	1.2%

Table 1
Uncertainty analysis (dRe/Re)

e (mm)	1	0.5	0.1
Re			
200	0.4%	0.4%	0.4%
2000	0.6%	0.7%	0.6%
6000	0.5%	0.5%	–

Table 1
Uncertainty analysis (dNu/Nu)

e (mm)	1	0.5	0.1
Re			
200	0.8%	1%	0.9%
2000	3.5%	1.6%	0.5%
6000	4.4%	3.8%	–

The thermal conductivity used in Nu was determined at the local film temperature T_{film} (average of wall and fluid bulk temperatures)

$$T_{film} = \frac{T_w + T_f}{2} \quad (2)$$

Uncertainties were analyzed and estimated. The results are given in Table 1. Two complete sets of measurements were performed independently by two experimenters. Most measurements were carried out twice by one of the two experimenters. Comparison of all the data showed an excellent reproducibility of the results.

4. Results and discussion

4.1. Geometrical parameters

The channel surface finish was analysed by a roughness measurement system Taylor–Hobson Surtronic 3+ with accuracy of the order of 0.1 μm . The radius R_a of roughness was found to be less than 0.1 μm . The thickness of the foils, which delimit the channel, was measured by a micrometer and found in excellent agreement with the thickness indicated by the manufacturer with accuracy of the order of 1 μm . The height of a channel, which plays a crucial role in the head losses ($\sim 1/e^3$ in laminar regime) is determined by this thickness. The height e was also measured by difference between the thickness of the test section without the foil and with the foil after tightening. The height e was again found with an accuracy of 1 μm .

4.2. Friction factor

The overall Fanning friction factor f was determined from pressure measurements at channel inlet/outlet. The classical hypothesis of constant pressure in the outlet sump was made to evaluate the pressure at the channel outlet. The inlet pressure was corrected by the inertia term accounting for flow acceleration in the converging channel entrance.

$$\Delta p_{i-o} = p_{in} - p_{out} \quad (3)$$

$$\Delta p_{entrance} = 0.5 \rho V^2 \quad (4)$$

$$\Delta p = \Delta p_{i-o} - \Delta p_{entrance} \quad (5)$$

$$\tau = \frac{\Delta p D_h}{4L} \quad (6)$$

$$f = \frac{\tau}{\frac{1}{2} \rho V^2} = \frac{\Delta p D_h}{2 \rho V^2 L} \quad (7)$$

where Δp_{i-o} is the pressure difference between inlet and outlet sumps, $\Delta p_{entrance}$ is the pressure reduction at the channel entrance, Δp is the net pressure drop in the micro channel and τ is the wall shear stress.

Experiments were carried out with a series of channel heights ranging from 0.1 mm to 1 mm. It was not possible to

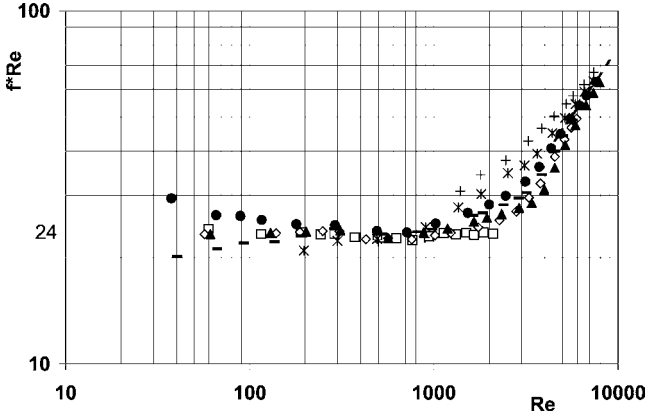

Fig. 3. Influence of Reynolds number and channel height on Poiseuille number: + $e = 1$ mm, * $e = 0.7$ mm, • $e = 0.5$ mm, ▬ $e = 0.4$ mm, ▲ $e = 0.3$ mm, ◇ $e = 0.2$ mm, □ $e = 0.1$ mm, --- Blasius law.

investigate larger channels owing to the limited range of the flowmeters.

Fig. 3 shows the Poiseuille number ($Po = fRe$) against the Reynolds number for all the channels investigated. It clearly shows that the theoretical value ($Po = 24$) is reached whatever the channel height for $Re < 1000$.

fRe is plotted as a function of the non-dimensional channel length ($L^+ = \frac{L}{D_h} \frac{1}{Re}$) and compared with the theoretical solution of the laminar regime [20,21] in Figs. 4 and 5 in order to identify entrance effects in the results.

The present results show that the experimental Poiseuille number tends to a constant value for sufficiently high values of L^+ . Entrance effects are therefore found to be negligible when L^+ is higher than about 0.1. As mentioned before, the classical law of the fully developed laminar regime ($Po = 24$) is found with a very good accuracy for all the tested microchannels up to the smallest channel height e (0.1 mm). Entrance effects on the overall friction factor are well taken into account by the following theoretical law for laminar developing flow in two-dimensional channels of usual size [21]

$$Po_{\text{lam}}(L^+) = \frac{3.44}{\sqrt{L^+}} + \frac{24 + \frac{0.674}{4L^+} - \frac{3.44}{\sqrt{L^+}}}{1 + \frac{2.9 \times 10^{-5}}{L^{+2}}} \quad (8)$$

Significant departures of the present results from this law occur for the smallest values of L^+ , which correspond to the highest flow rates and therefore to the highest values of the Reynolds number. This is a clear indication of transition to turbulence in the channel. A critical Reynolds number Re_{chyd} was defined by the condition that Po_{exp} exceeds by 10% Po_{lam} given by Eq. (8)

$$Re > Re_{\text{chyd}} \quad \text{for } Po_{\text{exp}} > 1.1Po_{\text{lam}} \quad (9)$$

Most values found for Re_{chyd} (Table 2) are close to the accepted value of 4000 for transition in plane wall channels [22] (note that Re is based on the hydraulic diameter in the present paper). The smallest values of Re_{chyd} are observed for the largest channels where the experimental uncertainties on the pressure drop are the highest.

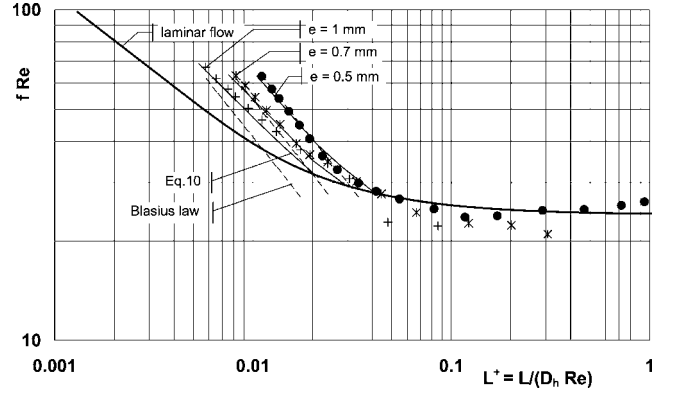

Fig. 4. Effect of channel size on Poiseuille number. Highest values of e . Same symbols as in Fig. 3: — laminar flow regime, White [21], --- Eq. (10), ---- Blasius law.

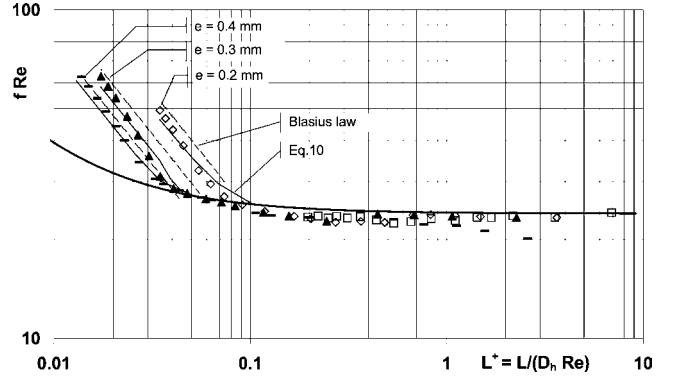

Fig. 5. Effect of channel size on Poiseuille number. Smallest values of e . Same symbols as in Fig. 3.

Table 2
Critical Reynolds number
 Re_{chyd} deduced from head-loss measurements

e (mm)	Re_{chyd}
1	2500
0.7	2500
0.5	3200
0.4	3800
0.3	4000
0.2	3300

Onset of transition occurs at some distance x_1 from the channel entrance. According to the heat transfer results, it was possible to make a crude estimation of x_1 as a function of Reynolds number. The experimental results were then compared to a computation of pressure losses which combines the laws of the laminar regime for $x < x_1$ and of the turbulent regime for $x > x_1$. x_1 was adjusted in order to give the best fit with the experimental data. Blasius law was used for the turbulent regime. The pressure losses are then modelled by

$$(fRe)_{\text{mod}} = (fRe)_{\text{lam}}(x_1^+) \cdot x_1^+ / L^+ + 0.079Re^{3/4} \cdot (1 - x_1^+ / L^+) \quad (10)$$

Table 3

Non-dimensional location of the start of transition of x_1/L used for the computation of pressure losses

e (mm)	1	0.7	0.5	0.4	0.3	0.2
Re						
<2000	1	1	1	1	1	1
2000	0.5	0.7	0.7	1	1	1
3000	0.5	0.6	0.5	0.8	1	0.6
3500	0.5	0.5	0.5	0.8	0.8	0.6
4000	0.5	0.5	0.5	0.6	0.6	0.5
8000	0.5	0.5	0.4	0.4	0.4	0.4

where $x_1^+ = \frac{x_1}{D_h} \frac{1}{Re}$ and $(f Re)_{lam}(x_1^+)$ is given by Eq. (8). The values of $x_1/L (= x_1^+/L^+)$ were chosen as indicated by Table 3.

The graph of Eq. (10) is drawn with solid lines in Figs. 4 and 5. $(f Re)$, as given by Blasius law applied all along the channel ($x_1^+ = 0$), is drawn with dotted lines in the same figures. Figs. 4 and 5 clearly show a good agreement of the experimental results with Eq. (10). For $e = 1$ mm, Blasius law applied for the whole channel strongly underestimates the pressure losses. This result may seem paradoxical and actually, it is not the case for other values of e (Fig. 5). This is due to the fact that the pressure losses are higher in the developing laminar regime than in the fully developed turbulent regime for certain flow conditions.

From the agreement of the experimental data with Eq. (8) (for $Re < Re_{c,hyd}$) and Eq. (10) (for $Re > Re_{c,hyd}$), it may be concluded that the overall friction factor is insensitive to the channel height e . This result holds true for the laminar regime and for the turbulent regime.

There is no sign of a faster transition to turbulence compared to conventional channel flows in the present results.

4.3. Heat exchange coefficient

Measurements of the local heat exchange coefficient require determination of the exchanged heat flux φ as well as the local wall and fluid temperatures. The global heat balance for a control volume consisting in the whole working section reads

$$P = \Phi_e + \text{thermal losses} \quad (11)$$

where P is the electric power dissipated by the heating resistances and Φ_e is the total enthalpy rise experienced by the stream between the channel inlet and outlet. Losses are mainly due to natural convection along the blocks external sides.

Fig. 6 shows that P and Φ_e are in balance with a good accuracy for a large range of flowrates used in these experiments. This result implies that the heat losses through the slabs delimiting the channel are small. It also shows that the total heat transfer rate Φ extracted by the fluid from the channel walls may be estimated with reasonable confidence by the measurements of P or Φ_e . The largest discrepancies

P, Φ_e (W)

Fig. 6. Electric power and total enthalpy convected by the stream versus flowrate: ■ P , $e = 1$ mm, Φ_e , □ $e = 1$ mm; ● P , $e = 0.1$ mm, Φ_e , ○ $e = 0.1$ mm.

are observed in Fig. 6 for the smallest flowrates. A possible explanation is that the fluid is then poorly mixed in the sump at the channel outlet and that, consequently, the outlet thermocouple does not determine the true bulk temperature T_{out} . Buoyancy effects may also contribute to deviate the hot jet at the microchannel exit so that the outlet thermocouple is not immersed in the stream in these conditions. The reduction of Φ_e may also be due to increasing heat losses for these very small flowrates.

To compute the local wall heat-flux extracted by the stream, it was assumed that the power density dissipated in the test section is uniformly distributed over the length of the heating resistances. However, the active length of the resistances $l_h (= 62$ mm) is smaller than the channel length (Fig. 7). As a result, the channel walls were not heated in the last part of the test section and the wall temperature decreased in the downward direction (Fig. 8). This decrease of T_w is due to the convective cooling of the wall by the flow. It was then necessary to take into account conductive effects inside the channel walls in order to interpret correctly the experimental data.

A one-dimensional model was developed for accounting conduction in the metallic slab, which is located between the resistances and the channel. The actual heating resistances were modeled by a plane of constant heat flux (φ_0) located at the distance a from the channel wall ($a = 4$ mm). φ_0 was determined by conservation of the total heat flux. The heating resistances are placed slightly upstream of the channel (4 mm), but this detail was neglected in the computations, in other words the channel heating was assumed to start at $x = 0$.

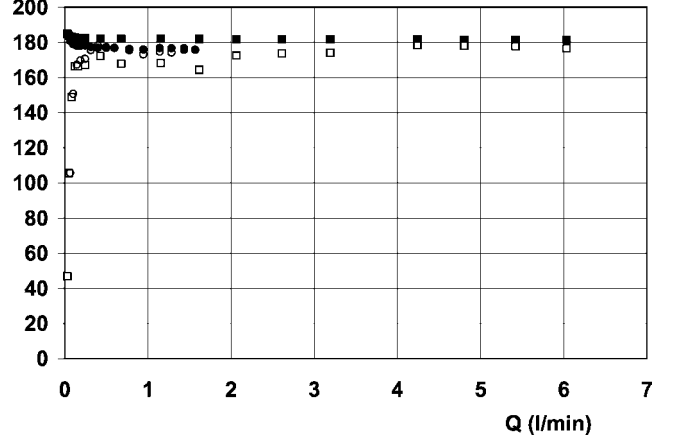
Considering a volume element of height a , length dx and width b in the spanwise direction (Fig. 7) and neglecting heat losses, the distribution of heat-flux at the heating resistance side ($y = a$) is modeled as follows

$$0 \leq x \leq l_h \quad \varphi_0 = \frac{P}{2bl_h} \quad (12)$$

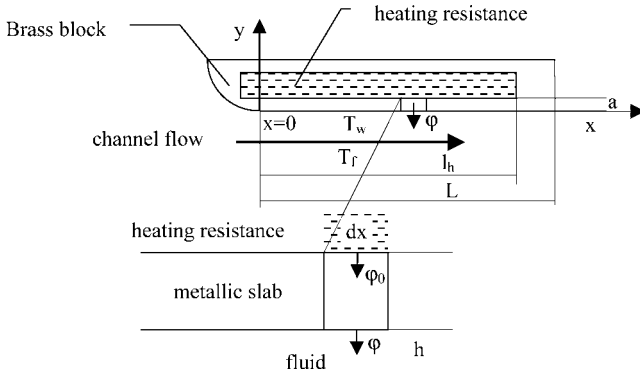

Fig. 7. Sketch of one-dimensional model for heat transfer.

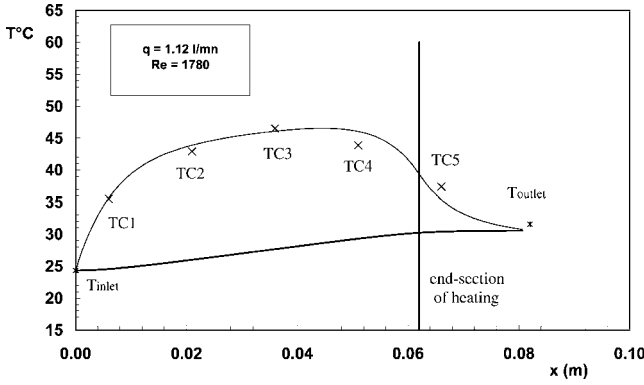

Fig. 8. Temperature distribution along the channel: × measured wall temperature, * measured inlet/outlet fluid bulk temperature, — computed wall temperature, — computed fluid bulk temperature.

$$l_h \leq x \leq L \quad \varphi_0 = 0 \quad (13)$$

The energy equation integrated over the wall cross-section ($a \times b$) yields

- in the heated part of the slab

$$0 \leq x \leq l_h \quad \varphi_0 = h(T_w - T_f) - k_w \frac{d^2 T_w}{dx^2} a \quad (14)$$

- in the unheated part of the slab

$$l_h \leq x \leq L \quad 0 = h(T_w - T_f) - k_w \frac{d^2 T_w}{dx^2} a \quad (15)$$

where T_f is the fluid bulk temperature.

The energy equation integrated over the channel cross-section yields

$$0 \leq x \leq L \quad \rho C_p Q \frac{dT_f}{dx} = 2h(T_w - T_f) \quad (16)$$

In the above equations, it is assumed that the temperature at the metal-fluid interface $T_w(x)$ is very close from the solid temperature integrated across the slab $\frac{1}{a} \int_0^a T(y) dy$ so that the conduction terms are estimated with T_w in the equations (14), (15).

The boundary conditions are given by the following equations

$$x = 0 \quad T_w(0) = T_f(0) \quad (17)$$

$$x = L \quad T_w(L) = T_f(L) \quad (18)$$

$$x = l_h \quad T_w(l_h^-) = T_w(l_h^+) \quad (19)$$

$$x = l_h \quad k_w \left(\frac{dT_w}{dx} \right)^- = k_w \left(\frac{dT_w}{dx} \right)^+ \quad (20)$$

The assumption that the end wall temperature equals the fluid temperature equation (18) is rather strong and may overestimate the conductive losses at the slab end. However, the results were only slightly modified when Eq. (18) was replaced by a condition of adiabatic wall at the slab end.

The above system of equations was resolved analytically by assuming the heat-transfer coefficient h as constant along the wall and the results of these calculations were compared to the temperature measurements.

A typical result is shown in Fig. 8 for the case of a very narrow microchannel ($e = 0.1$ mm). Fig. 8 compares the computed distribution of the wall and of the bulk fluid temperatures to the thermocouple measurements. The heat transfer coefficient was adjusted in the computation so as to give the best agreement with the temperatures measured by the thermocouples TC2 and TC3. Taking into account the experimental difficulties and the oversimplification of the model, the agreement of the computed temperatures with the measurements is considered to be satisfactory. The vertical solid line in Fig. 8 indicates the end-section of heating. The model predicts significant upstream conduction effects on the wall temperature near this section. Longitudinal conduction in the slab gives a sharp decrease of the heat flux φ , which is exchanged with the fluid. On the contrary, φ is constant in the mid-part of the channel, which corresponds to the measurement Sections 2 and 3. According to these computations, the heat flux exchanged with the fluid at Section 4 is reduced by a factor of about 10% up to 15% for the smallest flowrates. Fig. 8 shows that the temperature given by the thermocouple 4 is slightly lower than predicted by the model. This discrepancy may perhaps be attributed to three-dimensional effects, which are not accounted for by the model. From this comparison, it may be concluded that the measurements in Sections 2 and 3 are not affected by conductive effects and may be used to determine the heat transfer coefficient in the channel.

The local Nusselt number was therefore computed from the measurements by using the following relations

$$\varphi = \frac{P}{2bl_h} \quad (21)$$

$$T_f = T_{in} + (T_{out} - T_{in}) \frac{x}{l_h} \quad (22)$$

$$h = \frac{\varphi}{T_w - T_f} \quad (23)$$

$$Nu_x = \frac{hD_h}{k} \quad (24)$$

When Φ_e was smaller than the electric power P , this former parameter was used instead of P in Eq. (21).

As for pressure losses, the local Nusselt number Nu_x is plotted as a function of x^* ($= \frac{x}{D_h} \frac{1}{Re Pr}$) and compared with the theoretical solution [20] for $Pr = 4$ in Figs. 9–15 in order to identify entrance effects in the heat transfer results. For the sake of clarity, the results are displayed on different graphs corresponding to the different channel heights used in the present study. Nu_x was computed for Sections 1 to 4 although it has been shown that conduction effects may slightly overestimate the heat exchange coefficient in Section 4. These figures clearly demonstrate very good reliability of the present measurements since most results collapse on a single curve for the various combinations of the thermocouple positions and Reynolds number when the non-dimensional x^* is used in the graphs. Moreover, for $e = 1$ mm (Fig. 9), the results are in very good agreement with the theoretical solution in the greatest part of the x^* -range presently tested. However, two kinds of deviations are observed in Fig. 9.

Firstly, the experimental points corresponding to the thermocouple TC4 are significantly upper the theoretical curve for the lowest values of x^* . These conditions correspond to the highest flowrates used in the experiments. This rapid increase of Nu_x is observed for TC4 whatever the channel height when the flowrate is increased. This deviation cannot be accounted for by the conduction effects, which give

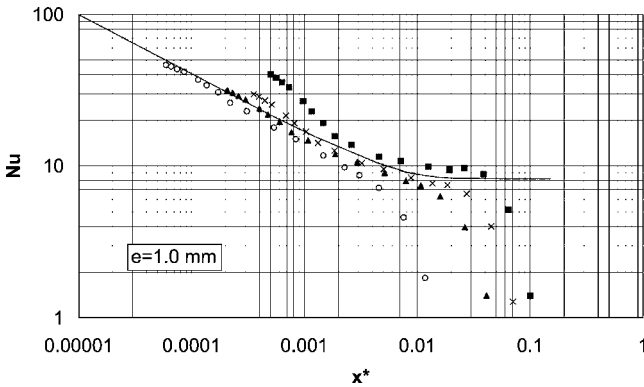

Fig. 9. Variations of Nusselt number along the channel for $e = 1$ mm: \circ Thermocouple 1, \blacktriangle Thermocouple 2, \times Thermocouple 3, \blacksquare Thermocouple 4, — laminar flow regime, Shah and London [20], $Pr = 4$.

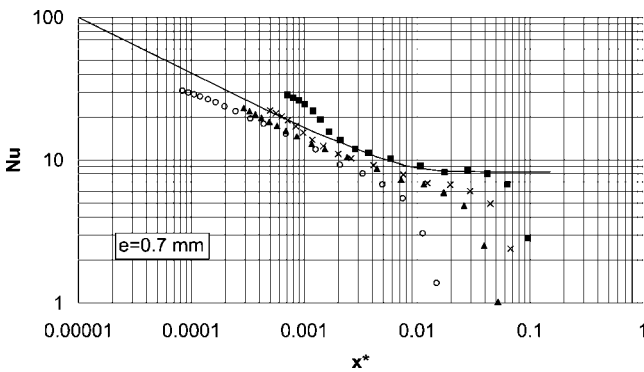

Fig. 10. Variations of Nusselt number along the channel for $e = 0.7$ mm. Same symbols as in Fig. 9.

an overestimation of about 10% only for Nu_x as indicated above. It is worth noting that Nu_x increases sharply at Section 4 when the Reynolds number exceeds a critical value $Re_{c,th}$, which slightly depends on e (Table 4). A similar behaviour is also observed at Section 3, but the increase of Nu_x is much smaller than at Section 4. The values found for $Re_{c,th}$ are again close to the accepted value of 4000 for transition in plane wall channels. It may then be concluded that this departure from Shah and London curve in Fig. 9 and more generally the sharp increase in Nu_x for narrower channels correspond to transition to turbulence in the microchannels. This conclusion is also supported by the pressure loss results (Section 4.2). The values found for $Re_{c,hyd}$ and $Re_{c,th}$ are in good general agreement.

Table 4
Critical Reynolds number $Re_{c,th}$ deduced from heat transfer measurements at Section 4

e (mm)	$Re_{c,th}$
1	2200
0.7	3300
0.5	3400
0.4	3400
0.3	3500
0.2	2300

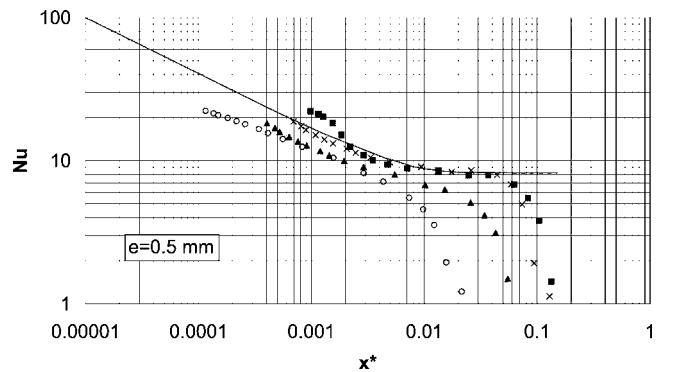

Fig. 11. Variations of Nusselt number along the channel for $e = 0.5$ mm. Same symbols as in Fig. 9.

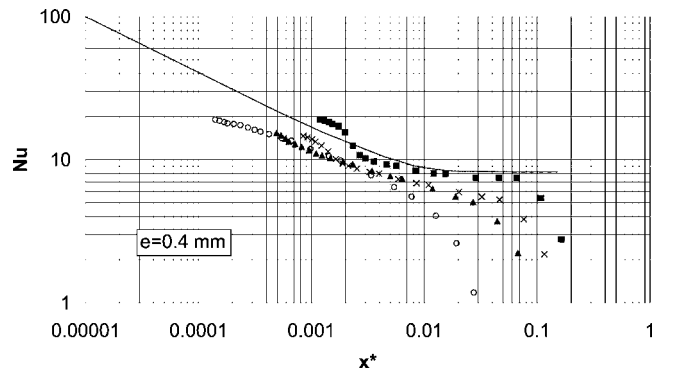

Fig. 12. Variations of Nusselt number along the channel for $e = 0.4$ mm. Same symbols as in Fig. 9.

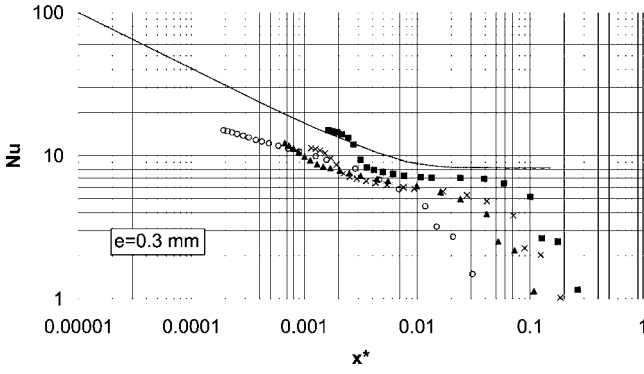

Fig. 13. Variations of Nusselt number along the channel for $e = 0.3$ mm. Same symbols as in Fig. 9.

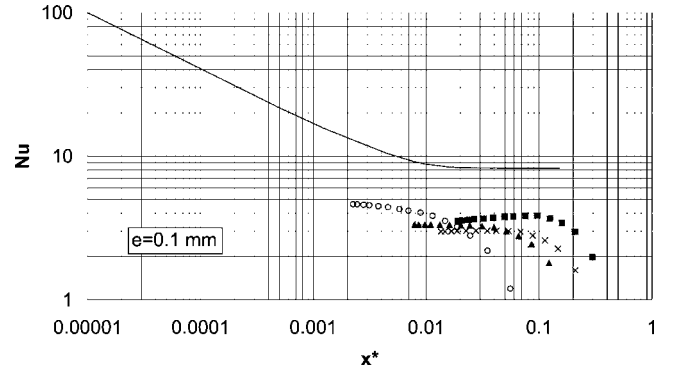

Fig. 15. Variations of Nusselt number along the channel for $e = 0.1$ mm. Same symbols as in Fig. 9.

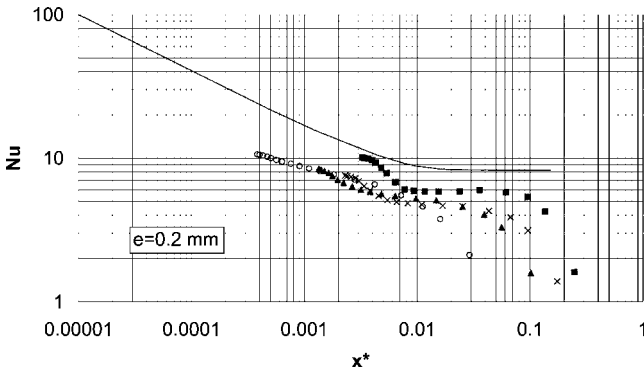

Fig. 14. Variations of Nusselt number along the channel for $e = 0.2$ mm. Same symbols as in Fig. 9.

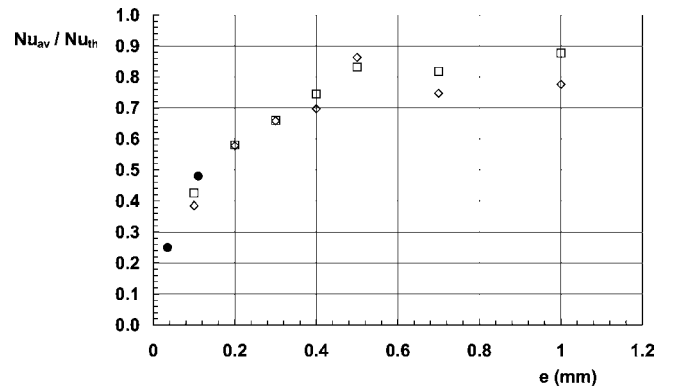

Fig. 16. Effect of channel size on Nusselt number. Present results: \square $x^* = 0.02$, \diamond $x^* = 0.004$, \bullet Qu et al. [19].

A second type of deviation from the theoretical curve and, more generally, an important scatter of the results occur when x^* is increased for a given thermocouple, i.e., when the flowrate is decreased. In fact, the observed rapid decrease of Nu_x is not linked to x^* as can be seen in Figs. 9–15, but to the small flowrates used in these conditions since it occurs for the same flowrate at the four measurement sections. This reduction of Nu_x corresponds to the low values of the total heat flux Φ_e measured for the smallest flowrates (Fig. 6). It is likely that Φ_e is incorrectly determined in these conditions as noted above and that the corresponding results for Nu_x are not reliable.

For a given x^* , Nu_x deduced from the thermocouple 4 is almost systematically higher than the three other ones, even in the laminar regime. This may be attributed to the conduction effects which lead to an overestimation of the local heat flux and consequently of the Nusselt number.

The striking result observed in Figs. 9–15 concerns the strong diminution of Nu_x with the channel height e . The average of the values of Nu_x given by the first three thermocouples for the same value of x^* was considered to specify the influence of e on heat transfer.

$$Nu_{av} = 1/3(Nu_x(T1) + Nu_x(T2) + Nu_x(T3)) \quad (25)$$

Fig. 16 shows Nu_{av}/Nu_{th} for $x^* = 0.004$ as a function of the channel height, where Nu_{th} is the theoretical value of Nusselt number for the same value of x^* [20]. This value of x^* was

chosen because it was possible to compute Nu_{av} from the data for all the heights considered, except for $e = 0.1$ mm. For this narrowest channel, $x^* = 0.004$ was reached by the thermocouple TC1 only and the corresponding Nu_x number is reported in Fig. 16. For the chosen value of x^* , the thermal regime is not fully developed and the theoretical value of Nu_x is $Nu_{x,th} = 10.2$. For $e = 1$ mm, Nu is 10% smaller than $Nu_{x,th}$. This discrepancy is mainly due to the value of Nu_x at Section 1, which seems to be underestimated for the small flowrate corresponding to $x^* = 0.004$ at this position as explained above (Fig. 9). If this thermocouple were discarded, Nu_{av} would be 9.9, very close to the theoretical value. An other set of results corresponding to $x^* = 0.02$ is also shown in Fig. 16. This non-dimensional distance corresponds to the fully developed regime for the theoretical solution. A plateau is actually observed in Figs. 14 and 15. However, the results are not reliable for the smallest flowrates as already noted. Thus, for this value of x^* , Nu_{av} was defined with the results deduced from the thermocouples TC2 and TC3 only. Moreover, the results are most probably underestimated for $e > 0.3$ mm because they are then associated to very small flowrates. The same tendency as for $x^* = 0.004$ is however observed in Fig. 16.

This significant reduction of Nu with the channel size is in agreement with previous findings [12,19,23]. The results of Qu et al. [19] are reported in Fig. 16 with the

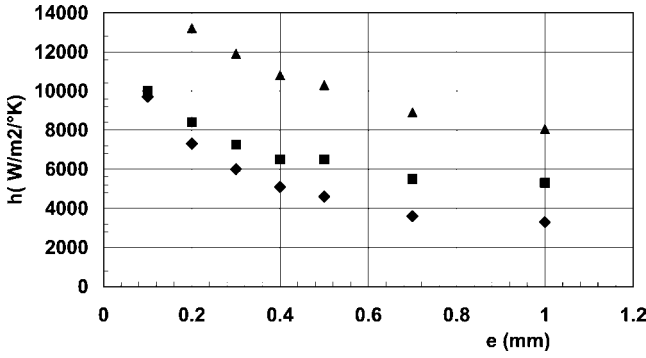

Fig. 17. Effect of channel size on heat exchange coefficient: \blacklozenge $Q = 0.35 \text{ l}\cdot\text{mn}^{-1}$, $Re = 600$, \blacksquare $Q = 1.5 \text{ l}\cdot\text{mn}^{-1}$, $Re = 2200$, \blacktriangle $Q = 4.7 \text{ l}\cdot\text{mn}^{-1}$, $Re = 6000$.

height of their microchannel on x -axis. Their channels N° 2 and 4 were considered for this comparison because they have the highest aspect ratio (respectively ≈ 11 and 4). In fact, it seems likely that the size effect is related to the smallest dimension of a microchannel. Thus it may be thought that the hydraulic diameter is inappropriate to represent correctly the phenomena at these very small scales. The hydraulic diameter was used in the present results for the sake of comparison with the classical laws of heat transfer. Moreover, for the very high aspect ratio used in this study, D_h is very close to $2e$. Fig. 16 shows an excellent consistency of the present results with those of Qu et al. although the aspect ratio is much higher in the present case.

It is worth noting that the reduction of Nu is very strong for the narrowest microchannels. For $e = 0.1 \text{ mm}$, Nu is about 60% smaller than the conventional value for large-scale channels.

For practical applications, it is also interesting to consider the dimensional heat transfer coefficient h . Fig. 17 is a plot of the average of h at Sections 2 and 3 for three constant values of the flowrate. In contrast to the preceding results, h strongly increases when the channel height is decreased. For example, h is notably higher for the narrowest channel ($e = 0.1 \text{ mm}$, $h \approx 1 \times 10^4 \text{ W}\cdot\text{m}^{-2}\cdot\text{K}^{-1}$) than for the broadest one ($e = 1 \text{ mm}$, $h \approx 0.33 \times 10^4 \text{ W}\cdot\text{m}^{-2}\cdot\text{K}^{-1}$) at the same flowrate ($Q = 0.35 \text{ l}\cdot\text{mn}^{-1}$). This increase of h corresponds to the large values of the temperature gradient due to the very small size of the microchannel.

4.4. Discussion of results

The results are summarised as follows. The present measurements of the overall friction factor and of local Nusselt numbers show that the classical laws of hydrodynamics and heat transfer are verified for $e > 0.4 \text{ mm}$. For lower values of e , a significant decrease of the Nusselt number is observed whereas the Poiseuille number keeps the conventional value of laminar developed flow. Both flow and heat transfer results are in agreement to show that onset of turbulence occurs in the microchannels at a critical Reynolds number Re_c in the range 3500–4000. This result is in agreement with values reported in the literature. A smaller value is obtained for

$e = 1 \text{ mm}$. However, experimental uncertainties are then the highest both for f and for Nu measurements and it is difficult to determine accurately Re_c in this case.

Previous findings show that the heat transfer coefficient is much more affected than the friction factor by the reduction of the channel size. Qu et al. [15] found an increase of the friction factor of 8–38% for hydraulic diameters ranging from $51 \mu\text{m}$ to $169 \mu\text{m}$. In the same facility, they observed reduction of the Nusselt number of about 60–75%. This behaviour is in contradiction with the Reynolds analogy, which at least would predict variations of f and Nu in the same direction. The authors attributed these modifications of the laws of transfer to roughness effects and they proposed a model to take these effects into account.

The present study concerns the flow near extremely smooth walls (roughness $< 0.1 \mu\text{m}$). The agreement of the present results with conventional laws for skin-friction in ducts is therefore not contradictory to Qu et al.'s model. However, the significant reduction of the Nusselt number with the size of the channel cannot be explained by such roughness effects in the present case.

The modification of heat transfer laws by electrokinetic effects seems also to be discarded at first sight, owing to the large difference of scales between the channel height and the double diffusive layer thickness. Another possible physical phenomenon could be air trapping close to the walls [18]. As air conductivity is much smaller than that of water, the presence of fine layers of air could explain the important reduction of the exchange coefficient. Furthermore, it seems likely that the friction factor would be little affected by such fine layers of air. This phenomenon would therefore explain at once the reduction of the heat transfer coefficient and the negligible variation of the friction factor. However, the formation of such air layers is doubtful in the present test section where the walls are very smooth. At the present time, there is no satisfactory explanation of the present results.

5. Conclusion

Two-dimensional microchannels were investigated in the present study. The design of the test section enabled variations of the channel height by steps of 0.1 mm , from 1 mm , which corresponds to plane walls channels of usual size to the smallest height of 0.1 mm , where size effects were suspected to affect the flow dynamics and heat transfer. It should be emphasized that the channel walls were the same surfaces during all the experiments. This does not mean that the surface finish may not play a different role in the hydrodynamics or the heat transfer problems for the various microchannels presently tested, but it eliminates the variability of this parameter, which is present in experiments carried out in channels etched in silicon wafers.

Flow and heat transfer measurements were interpreted by using a non-dimensional distance to the channel inlet (respectively, L^+ or $x^* = x/(D_h Re Pr)$). This presentation

clearly identifies entrance effects and transition to turbulence. Separation of these two effects would not have been possible by using classical plots of the friction factor f or of the Nusselt number as a function of Reynolds number. The classical laws of friction in two-dimensional ducts are well verified both in the laminar and the turbulent regimes. No scale effects were found in the present experiments for the flow hydrodynamics.

Considering heat transfer results, the theoretical Nu_x vs x^* relationship is also well verified for the channels of largest scale in the laminar regime. However, for $e < 0.5$ mm, the plots of $Nu_x(x^*)$ show a departure from the theoretical heat transfer law, which grows when the channel height is decreased. The reduction of Nu is very strong for the narrowest microchannels. For $e = 0.1$ mm, Nu is about 60% smaller than the conventional value for large-scale channels. As discussed above, the physical interpretation of the results is very difficult. Local measurements would be helpful to understand the phenomena involved in these flows.

Further experiments will be conducted with other fluids and other surface finish in order to identify the phenomena governing this flow. It is planned to carry out investigations of microchannel flows with a low surface tension fluid obtained by mixing demineralized water and a wetting agent. Other experiments will be conducted with rough walls. Further insight in the flow phenomena should be provided by visualizations, which will be soon performed in a test section with transparent walls. Measurements with microsensors are also planned in the near future.

Acknowledgements

This research was supported by the program ECODEV-CNRS. The authors would like to gratefully acknowledge the China Scholarship Council for supporting the stay of P. Gao in LEGI. They also wish to thank S. Pradal and T. Klajny for performing some of the experiments and Dr. S. Tardu for participating to the initiation of this research.

References

- [1] M. Anduze, Etude expérimentale et numérique de microécoulements liquides dans les microsystèmes fluidiques, Ph.D. Thesis, I.N.S.A.Toulouse, France, 2000.
- [2] S.M. Flockhart, R.S. Dhariwal, Experimental and numerical investigation into the flow characteristics of channels etched in '100' Silicon, *J. Fluids Engrg.* 120 (1998) 291–295.
- [3] B. Gromoll, Micro cooling systems for high density packaging, *Rev. Gén. Therm.* 37 (1998) 781–787.
- [4] C. Perret, C. Schaeffer, J. Boussey, Integration of micro heat sink in silicon technology, IWIPP '98.
- [5] D.B. Tuckermann, R.F. Pease, Optimized convective cooling using micromachined structure, *J. Electrochem. Soc.* 129 (3) (1982) C98.
- [6] D.B. Tuckermann, R.F. Pease, High performance heat sinking for VLSI, *IEEE Electronic Device Lett.* 2 (1991) 126–129.
- [7] S.B. Choi, R.F. Barron, R.O. Warrington, Fluid flow and heat transfer in microtubes, in: Cho, et al. (Eds.), *ASME DSC 32* (1991) 123–134.
- [8] B.X. Wang, X.F. Peng, Experimental investigation on liquid forced convection heat transfer through micro-channels, *Internat. J. Heat Mass Transfer* 37 (1) (1994) 73–82.
- [9] A.B. Duncan, G.P. Peterson, Review of microscale heat transfer, *Appl. Mech. Rev.* 47 (9) (1994) 397–428.
- [10] A. Bricard, Ecoulement et transfert de chaleur dans les micro-canaux et dans les microcaloducs, STI/LASP 95.01, CENG/CEA Grenoble, France, 1995.
- [11] G.P. Celata, M. Cumo, G. Zummo, Experimental investigation of single-phased forced convection heat transfer in capillary tubes with refrigerants, in: *Colloque Eurotherm 'Microscale Heat Transfer'*, Vol. 57, Poitiers, France, 1998.
- [12] X.F. Peng, G.P. Peterson, B.X. Wang, Heat transfer characteristics of water flowing through microchannels, *Exp. Heat Transfer* 7 (1994) 265–283.
- [13] J. Pfahler, J. Harley, H. Bau, J.N. Zenel, Gas and liquid flow in small channels, *ASME Paper, DSC*, Vol. 32, 1991, pp. 49–60.
- [14] A.B. Duncan, G.P. Peterson, Review of microscale heat transfer, *Appl. Mech. Rev.* 47 (9) (1994) 397–428.
- [15] W. Qu, M.Gh. Mala, L. Dongqing, Pressure-driven water flows in trapezoidal silicon microchannels, *Internat. J. Heat Mass Transfer* 43 (2000) 353–364.
- [16] M.G. Mala, L. Dongqing, J.D. Dale, Heat transfer and fluid flow in microchannels, *Internat. J. Heat Mass Transfer* 40 (13) (1997) 3079–3088.
- [17] L. Ren, W. Qu, D. Li, Interfacial electrokinetic effects on liquid flow in microchannels, *Internat. J. Heat Mass Transfer* 44 (2001) 3125–3134.
- [18] M.N. Sabry, Scale effects on fluid flow and heat transfer in microchannels, in: *Conf. Therminice*, Rome, 10/1999.
- [19] W. Qu, G.M. Mala, D. Li, Heat transfer for water flow in trapezoidal silicon microchannels, *Internat. J. Heat Mass Transfer* 43 (2000) 3925–3936.
- [20] R.K. Shah, A.L. London, *Laminar Flow Forced Convection in Ducts*, Advanced Heat Transfer, Academic Press, New York, 1978.
- [21] F.M. White, *Viscous Fluid Flow*, 2nd Edition, McGraw-Hill, New York, 1991.
- [22] D.R. Carlson, S.E. Widnall, M.F. Peeters, A flow-visualization study of transition in plane Poiseuille flow, *J. Fluid Mech.* 121 (1982) 487–505.
- [23] F. Debray, J.P. Franc, T. Maître, S. Reynaud, Measurements of Convection Heat Transfer Coefficients in Mini-Channels, *Colloque Microhydrodynamics*, Paris, 2000.