



**HAL**  
open science

## Sensor array for fetal ECG. part 2: Sensor selections

Vincent Vigneron, Annabelle Azancot, Christophe Herail, Manuel Schmidt,  
Olivier Sibony, Christian Jutten

► **To cite this version:**

Vincent Vigneron, Annabelle Azancot, Christophe Herail, Manuel Schmidt, Olivier Sibony, et al..  
Sensor array for fetal ECG. part 2: Sensor selections. 2nd IEEE International Conference on Com-  
putational Intelligence in Medical and Healthcare, Jun 2005, Costa da Caparica, Lisbon, Portugal.  
pp.434-442. hal-00203397

**HAL Id: hal-00203397**

**<https://hal.science/hal-00203397>**

Submitted on 9 Jan 2008

**HAL** is a multi-disciplinary open access archive for the deposit and dissemination of scientific research documents, whether they are published or not. The documents may come from teaching and research institutions in France or abroad, or from public or private research centers.

L'archive ouverte pluridisciplinaire **HAL**, est destinée au dépôt et à la diffusion de documents scientifiques de niveau recherche, publiés ou non, émanant des établissements d'enseignement et de recherche français ou étrangers, des laboratoires publics ou privés.

# SENSOR ARRAY FOR FOETAL ECG. PART 2: SENSOR SELECTION.

V. VIGNERON<sup>1,2,3</sup>, A. AZANCOT<sup>4</sup>, C. HÉRAIL<sup>2</sup>, M. SCHMIDT<sup>1</sup>, O. SIBONY<sup>4</sup> AND C. JUTTEN<sup>1</sup>

<sup>1</sup>LIS-INPG, France   <sup>2</sup>LSC, France   <sup>3</sup>MATISSE-SAMOS, France   <sup>4</sup>Hôpital R. Debré, France

## ABSTRACT

Non invasive foetal electrocardiogram (ECG) extraction involve measurements from electrodes located on different points of the mother's skin. As a result, foetal ECG (fECG) and maternal ECG (mECG) components appear mixed together in the recordings, in addition with some random disturbances, such as mother electromyograms, thermal noise from the electrodes, etc. Fetal contribution however is minor by comparison with these electrical sources and classical signal processing, like filtering, does not allow us to recover the fECG. The task of obtaining the fECG from the rest of non-desired signals, that disturb the cutaneous recordings, can be coped by using blind source separation (BSS) tools. In the following, we propose some conditions on the number and location of the sensors so that the extraction is optimal.

## 1. INTRODUCTION

So-called *non invasive techniques* have been shown to be very efficient for fECG extraction [1, 2]. Recently, some authors have shown that this problem can fit into the blind source separation (BSS) framework, where the *mixtures* are the signals recorded by external sensors. If their mixture is linear, instantaneous and noise-free, the well-known method of independent component analysis (ICA) is able to recover the original sources, up to a scale factor and permutation. Note that, if the identification of fECG signal among all the estimated sources is a quite easy task, extracting a complete PQRST waveform requires much more effort, especially due to the residual noise [3]. A necessary condition to recover the original sources is that the number of external sensors must be greater or equal to the number of original sources. While it may be appropriate to design a network that densely populate the mother abdomen with electrodes during sensor deployment, operation of the network may not require that all network nodes be operating. Indeed, for efficient operation, it may be desirable to select a subset of nodes such that (i) 2 sensors don't record exactly the same signal, (ii) all sources must be involved in the recording with a non-zero variance, (iii) electrodes providing irrelevant signals are rejected, (iv) the low power of the fECG signal can be improved, (v) there doesn't exist an optimal location of the sensors, constant in time as the foetus moves. These considerations, in addition to the low power of the fECG signal explain why the locations of the electrodes can improve the fECG extraction, while others can decrease its efficiency.

An appropriate algorithm for node subset selection in a densely populated network can be highly dependent on prior information about the signal and noise. In this paper, we explore strategies based on sensor selection and analyse the resulting algorithm's performance. We will show that sensor selection is a *viable* approach in the absence of reliable and detailed prior information. The signals analyzed here are the sum of the electrical fields generated by

several simulated sources for which an electrical model has been derived (see [4]). In section II, we consider the need for differential measurements and detail the proposed electronic architecture. Section III analyses the performance of selection algorithms. Section IV describes an algorithm which chooses electrode pairs based on geometrical calculation. Section V reviews our results and discusses direction for further investigation.

## 2. TWO STRATEGIES FOR ELECTRODE SELECTION

The aim of choosing electrodes is to enhance the quality of the output signal. This quality is strongly compromised by the fact that the signal of interest, *i.e.* the signal of the foetus, is overlaid by other signals with an equal or higher amplitude. The amplitude of the maternal heart is about 5-20 times higher than that of the foetus. Hence, to make the signal of the foetus observable the sources have to be separated. This is not possible by conventional linear filtering as the signals overlap in time and frequency space. For that reason, Independent Component Analysis (ICA) are applied. ICA is a signal processing technique capable of separating signals out of an *unknown mixture* of independent sources. As former investigations have shown, applying ICA to the signals of experimental found electrodes is not satisfying. With selecting optimal electrodes the quality of the input signal of the ICA procedure will increase and thus also the quality of the output. The reason for the fact that some electrodes are better than others is that the sources are not emitting homogeneously in every direction but for every source there are regions of maximal and regions of minimal amplitude [4].

To obtain a voltage measurement, it is always necessary to measure the difference of two potentials  $U_2$  and  $U_1$  due to the definition of voltage

$$U_{12} = U_2 - U_1. \quad (1)$$

Thus every measurement of electrode signals is the difference between the potential at one electrode and the potential at a "reference" electrode, which is performed by a differential amplifier. The most useful way is to choose the reference electrode also out of the electrodes attached to the body surface. This has the following reasons: First, noise which is added to every measurement with the same amplitude, is *almost* eliminated by measuring the difference of two signals. Second, with measuring between two points, the measurement is directed. This is explained using the example of one dipole and two electrodes as illustrated in figure 1.

If the line connecting the two electrodes is orthogonal to the dipole (Fig. 1.a), then the same signal is measured at both electrodes due to the symmetry of the dipole field and thus the difference is zero. On the other hand, if the measurement is parallel to the dipole direction (Fig. 1.b),

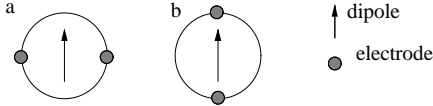

Figure 1: Direction of measurements.

the signals have the opposite polarity and thus the difference has two times the amplitude of the signal of one single electrode. This could be taken advantage of by finding electrode pairs which are *orthogonal* to the mother's dipole and *parallel* to the foetus' dipole, *i.e.* only the foetus' signal is captured. As a conclusion, the task is to find pairs of electrodes so that their measurements are optimized in order to separate the sources.

A criterion or cost function for that optimization has to be defined. Two ways for finding optimal electrodes can be identified:

1. The first possibility is to get the measurements of all electrodes, to compute the cost function of every electrode pair and to select the pairs with the lowest value. This would mean the computation of all possible combinations of two electrodes.
2. The second way could be to select electrode pairs *randomly* and change their position iteratively by only using a subset of measurements.

Some naming conventions which will be proposed in the following: the measurement of one electrode is called *unipolar measurement*. A measurement between one electrode and its reference electrode is called *differential measurement*. That implies, that both electrodes are connected to the same amplifier (see Fig. 2). A measurement between two arbitrary electrodes not connected to the same amplifier is called *bipolar measurement*.

Unaffected by the cost function used, several questions came up concerning the optimal electrodes found:

1. Are those electrodes, for which the criterion is fulfilled best, also the best for another criterion, which is impossible to measure? One answer regarding an example criterion could be that the measurement with the lowest amplitude of the mother is the best for observing the foetus. But the signal of the foetus may not be visible at all in this measurement.
2. What if the solution is not one single but a set of different measurements? An additional criterion has then to be applied to this set. *E.g.* the bipolar measurements with minimal maternal amplitude are those orthogonal to the maternal heart vector but, among these, are also those orthogonal to the foetal heart vector. Thus, out of the electrodes orthogonal to the maternal heart vector, those electrodes have to be chosen, which are most parallel to the foetal heart vector.
3. Does there exist, among the latter set of different measurements, a trivial one? *E.g.* one measurement with minimal maternal amplitude could be received when using a first electrode as reference and a second electrode which is the same as, or as near as possible to that reference. In that case, this solution has to be excluded.

### 3. PROPOSED HARDWARE ARCHITECTURE

Besides the problem of choosing the appropriate criterion exists the task of implementing the algorithm into hardware. For this task, the future architecture has to be regarded. The most important fact is that it is not possible

to collect the whole set of measurements during one sampling time, because the electrodes must be multiplexed to the amplifiers. Hence not all possible measurements are available at the same time and it is not possible to select one pair of electrodes with respect to the total number of combinations, *i.e.*  $L \times (C - 1)/2$ . Additionally, each amplifier has one fixed reference electrode and can only be connected to some electrodes as illustrated by figure 2.

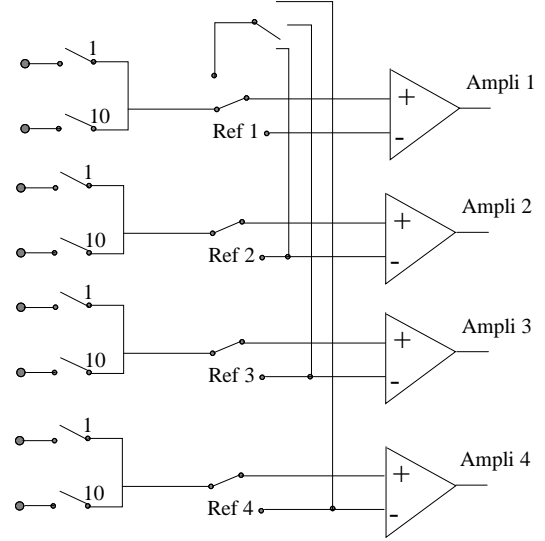

Figure 2: Proposed electronic architecture.

Consider the situation in which the sensors are uniformly distributed and form a  $L$ -by- $C$  array, located around the pregnant woman abdomen [5]. The sensors' relative positions are known and labelled with  $\mu = 1, \dots, L$  and  $\eta = 1, \dots, C$ . Each electrode is defined as a duplet of integers  $e_i = (\mu_i, \eta_i)$   $1 \leq \mu_i \leq L, 1 \leq \eta_i \leq C$ , where  $\mu_i$  is the coordinate in the direction feet to head, and  $\eta_i$  the coordinate on the abdominal circle. Let  $\mathcal{E} = \{e_1, \dots, e_n\}$  be the set of sensor elements ( $n = L \times C$ ). Any differential measurement  $m_{ij}$  can be defined as a selection of two electrodes  $m_{ij} = (e_i, e_j), 1 \leq i, j \leq n$ . Reference electrodes are defined as  $e_{Ri} = (\mu_{Ri}, \eta_{Ri})$ . Due to the proposed architecture detailed figure 2, differential measurements are only possible between electrodes connected to the same amplifier. Let defined by  $\mathcal{M}$  the set of these differential measurements. The subset of electrodes connected to the same amplifier  $i$  is defined as  $\mathcal{E}_{Ri} = \{e | (e, e_{Ri}) \in \mathcal{M}\}$ .

## 4. SENSOR PURSUIT ALGORITHM ADOPTED TO THE ARCHITECTURE

### 4.1 Finding the first two electrode pairs

A possible algorithm will be proposed in the following. The criterion to be maximized is the amplitude of the signal during the interval  $[t_1, t_2]$  while the maternal heart is not active. This time interval can be retrieved from thoracic ECG measurements as it is shown in figure 3.

The electrode grid is illustrated by figure 4, where reference electrodes  $e_{Ri}$  are fixed at positions  $(\mu_{Ri}, \eta_{Ri})$  and associated electrodes  $e_i$  at variable positions  $(\mu_i, \eta_i)$ . Let us define  $k$  the index of iteration steps. Assigned to each reference electrode  $e_{Ri}$  is a set of electrodes with variable po-

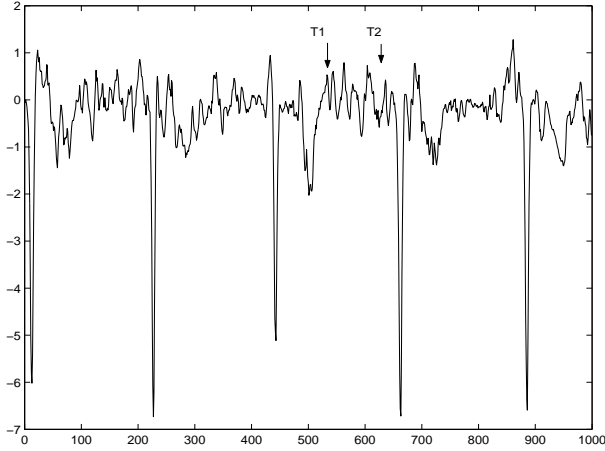

Figure 3: Thoracic ECG signal and inactive maternal heart period  $[T_1, T_2]$ .

sition  $(\mu_i^{(k)}, \eta_i^{(k)})$ . For simplicity, it is assumed that one reference electrode is at each row of the electrode grid and the assigned set consists of the other electrodes of that row, as shown in figure 4. This leads to  $\mu_{Ri} = \mu_i^{(k)}$  for all  $k$ . This means that the coordinate  $\mu$  is the same for all electrodes connected to the same amplifier. Further, the coordinate  $\mu_i$  chosen at iteration step  $j$  will be referenced as  $\mu_i^{(k=j)}$  or, shorter,  $\mu_i^j$ .

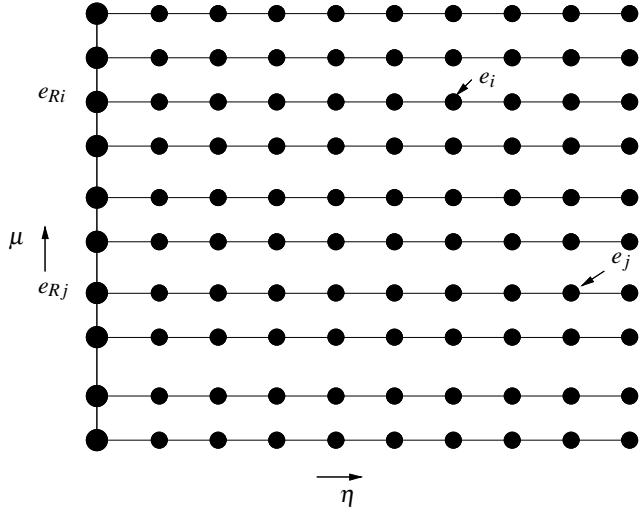

Figure 4: 10-by-10 electrode grid.

Differential measurements are only possible between a reference and one electrode in the set assigned to that reference. Unipolar measurement is written as  $u(\mu, \eta, t)$ , and  $t$  is the time index. Differential measurement is given through time by:

$$d(e_{Ri}, e_i, t) = u(\mu_{Ri}, \eta_{Ri}, t) - u(\mu_i, \eta_i, t) = d_i. \quad (2)$$

Bipolar measurements between two arbitrary electrodes on the grid, which are not connected to the same reference

electrode is:

$$b(e_i, e_j, t) = d(e_{Rj}, e_j, t) - d(e_{Ri}, e_i, t) + d(e_{Ri}, e_{Rj}, t) = b_{i,j}. \quad (3)$$

The further algorithm will optimize the placement of the first two electrodes  $e_1$  and  $e_2$ . First, the derivatives in the direction of  $\mu$  and  $\eta$  during the mother inactive heart period  $[t_1, t_2]$  are approximated:

$$D_{\mu 1} = \frac{1}{N} \left[ \sum_{t=t_1}^{t_2} b(\mu_1 + 1, \eta_1, \mu_2, \eta_2, t) - b(\mu_1, \eta_1, \mu_2, \eta_2, t) \right] \quad (4)$$

$$D_{\eta 1} = \frac{1}{N} \left[ \sum_{t=t_1}^{t_2} b(\mu_1, \eta_1 + 1, \mu_2, \eta_2, t) - b(\mu_1, \eta_1, \mu_2, \eta_2, t) \right] \quad (5)$$

$$D_{\mu 2} = \frac{1}{N} \left[ \sum_{t=t_1}^{t_2} b(\mu_1, \eta_1, \mu_2 + 1, \eta_2, t) - b(\mu_1, \eta_1, \mu_2, \eta_2, t) \right] \quad (6)$$

$$D_{\eta 2} = \frac{1}{N} \left[ \sum_{t=t_1}^{t_2} b(\mu_1, \eta_1, \mu_2, \eta_2 + 1, t) - b(\mu_1, \eta_1, \mu_2, \eta_2, t) \right] \quad (7)$$

where  $N$  is the number of summands, *i.e.* the number of samples during the mother inactive heart period. Once eq. (4-7) are complete, the position will be changed in the direction of the derivative:

$$\mu_1^{(k+1)} = \mu_1^{(k)} + \alpha D_{\mu 1} \quad (8)$$

$$\eta_1^{(k+1)} = \eta_1^{(k)} + \alpha D_{\eta 1} \quad (9)$$

$$\mu_2^{(k+1)} = \mu_2^{(k)} + \alpha D_{\mu 2} \quad (10)$$

$$\eta_2^{(k+1)} = \eta_2^{(k)} + \alpha D_{\eta 2} \quad (11)$$

where  $\alpha$  is a positive constant called *learning factor*.

The next iteration step starts with calculating other derivatives. This procedure will *maximize* the amplitude of the signal during mother inactive heart period. But, if two neighbored positions have the same foetal amplitude and that one has higher noise than the other, the electrode with the higher noise will be chosen. In order to avoid this drawback, the algorithm could be used during the interval where the amplitude of the mother ECG is dominant: the aim of the procedure is then to minimize the signal. To do so only  $t_1$  and  $t_2$  have to be changed and the learning factor  $\alpha$  is now set negative.

Due to the fact that the values for  $D$  vary largely, it is difficult to set the appropriate value for the learning factor  $\alpha$ . Making  $\alpha$  smaller will make the algorithm stop earlier. Making  $\alpha$  larger results in larger steps at the beginning. This could prevent the algorithm from converging to one blurred solution. A possible solution would be to replace the term  $\alpha \cdot D$  by  $sign(D)$ . Thus, after each step, the coordinates are changed by one. This might seem too slow but with a 10-by-10 electrode grid, the maximal number of iterations needed to converge is 10. Once the right position is found, the movement of the foetus will only induce small changes of the electrode position.

This algorithm converges to a maximum but it is not ensured that this is a global one (see [6]). In other words, the algorithm might get blocked in "local maxima". Evaluating the signals from the simulator, no local maximum was found, but though, the existence of local maxima cannot be excluded for *real data*.

This algorithm is used to select one first pair of electrodes with maximal maternal amplitude and another one with maximal foetal amplitude. This works under the assumption that the noise is *equally distributed* over the electrode grid or, at least, that the difference in noise between two electrodes is negligible with respect to the difference in foetal signal amplitude.

#### 4.2 Finding Further Pairs...

Let  $X$  defines the set of measurement:  $X = [\mathbf{x}_1 \mathbf{x}_2 \dots \mathbf{x}_n]$ , where  $\mathbf{x}_i = (x_{i1}, \dots, x_{iT})^T$  is the data vector of sensor  $i$  and  $T$  is the transpose operator. More electrode pairs are found by minimizing the correlation between an additional pair and a pair already found. This could be achieved by changing equations (4-7) to the following correlation difference:

$$D = \mathbb{E}[\mathbf{x}_d \mathbf{x}_r] - \mathbb{E}[\mathbf{x}_o \mathbf{x}_r], \quad (12)$$

where  $\mathbf{x}_r$  denotes the signal of the already found pair,  $\mathbf{x}_o$  denotes the signal of the additional pair at the actual position and  $\mathbf{x}_d$  is the signal of the additional pair moved the same way as in equations (4-7). These signals are first centered.

When computing the correlation by equation (12), it is only possible to receive the correlation between two electrode pairs. But it is necessary to have one single criterion which reflects the correlation between one new signal and an arbitrary number of already found signals. It was proposed to use the angle between the axis of the new signal and the eigenvector of the new signal. By eigenvector and eigenvalue is meant the eigenvector and eigenvalue of the full correlation matrix of the signals  $\mathbb{E}[X^T X]$ . The explanation for this uses statistical matters [6] which will be outlined in the following, while the first and second signals are always the signals of the already found electrode pairs and the third signal is always the signal of a new electrode pair whose placement has to be optimized. The problem is located near the problem of principle component analysis, which is discussed in detail in [7].

In the following, all signals are assumed to have zero mean, which could be easily achieved by subtracting the mean from the signals. The correlation between two signals could also be seen as in figure 5 where the lines indicate the eigenvectors of the signals. When one signal is already recorded and a second one has to be found, the two signals are uncorrelated if the eigenvector of the second signal is lying parallel to the axis of the second signal (figure 5.b). The two signals can be correlated if the eigenvalues are rotated as in figure 5.a.

Thus the angle between the eigenvector and the axis of the new signal can be used as a scalar criterion for the uncorrelatedness of the signals. The angle between two vectors  $\mathbf{a}$  and  $\mathbf{b}$  is calculated by equation (13):

$$\varphi = \arccos \left( \frac{\mathbf{a} \cdot \mathbf{b}}{|\mathbf{a}| |\mathbf{b}|} \right) \quad (13)$$

This calculation works also for higher dimensions and is used as the quality criterion. Figure 6 shows the eigenvectors of the signals before (a) and after (b) the iterative optimization.

One problem of this optimization was, that the differential signal of two electrodes very near to each other is uncorrelated with any other signal but electrodes like that are not useful for a measurement. The approach of the two electrodes to each other is accompanied by a significant decrease of the eigenvalue of the new measurement. Thus if

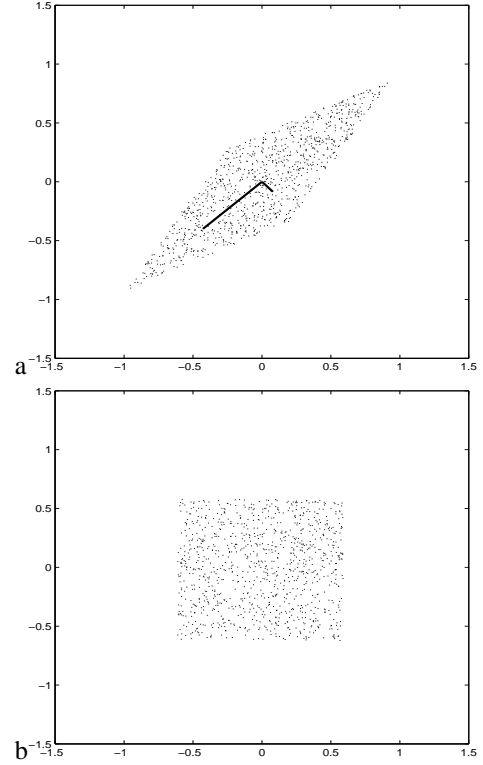

Figure 5: Distributions of Variables

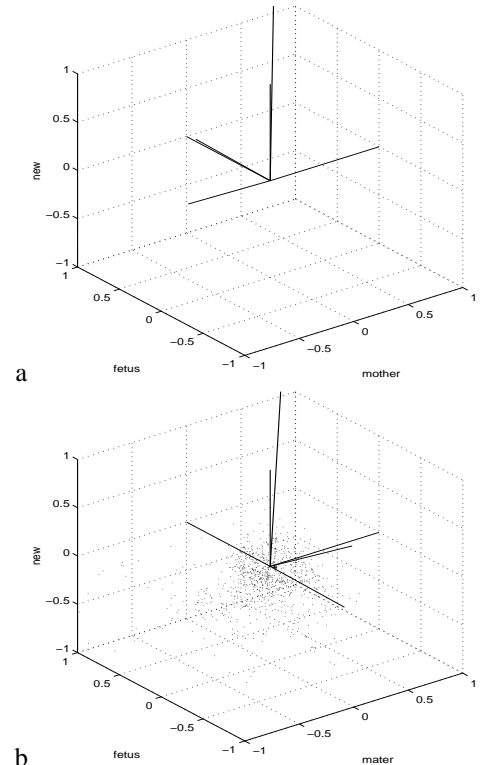

Figure 6: Eigenvectors for three dimensions

the eigenvalue is beneath a certain threshold, the electrodes are replaced randomly. The correlations between the new signal and the two already found signals over the iteration index is plotted in figure 7.

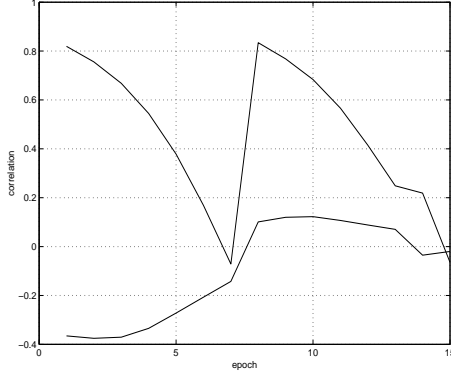

Figure 7: Correlations

At iteration 6 to 7, the steep edge indicates the *replacement* of the electrodes. This procedure can be used to find a third electrode pair but not to find further pairs. The reason for that is the following: the algorithm is based on following the gradient to an extremum but it cannot be guaranteed that this is a global extremum. Regarding the two signals which are optimized for the foetus and the mother, the correlation landscape is mostly *monotonic* as in these signals one component (mother or foetus) is *dominant* and thus the correlation declines with the the declination of the dominant component. But the third signal is chosen so that the two dominant components of the first two pairs are the least existent, thus the correlation landscape is quite irregular as shown in figure 8.

It is obvious that the global minimum can be found for the first two signals of the mother and the foetus but hardly for the third one. Thus, it is hardly possible to find a fourth electrode pair which is least correlated with the others.

## 5. GEOMETRY BASED ALGORITHM

This algorithm proposed to select an arbitrary number of electrode pairs by covering best the electrode grid and all possible directions starting with *at least one* already found electrode pair. For every electrode on the belt, the distance in space to an other found electrode  $e_{\mu,\eta}$  is calculated and the squared inverse of the distances to all  $m$  found (*single*) electrodes  $f_i, i = 1, \dots, m$  is cumulated. In the following bold characters describe coordinate vectors with  $x, y$  and  $z$  components:

$$d_{\mu,\eta} = \sum_{i=1}^m \frac{1}{|\mathbf{f}_i - \mathbf{e}_{\mu,\eta}|^2} \quad \mu = 1 \dots L, \eta = 1 \dots C. \quad (14)$$

The indices  $\mu, \eta$  of the lowest of all  $d_{\mu,\eta}$  are the indices of the first electrode  $f_{m+1}$  of the new pair. Thus this electrode is the most far away from the others. The second electrode of the line connecting the two electrodes, is most different (or orthogonal) to the direction of the pairs already found. To achieve that, the vector of the connection lines of the already found electrodes,  $f_{2i-1}$  and  $f_{2i}$  forming one pair  $p_i$ ,

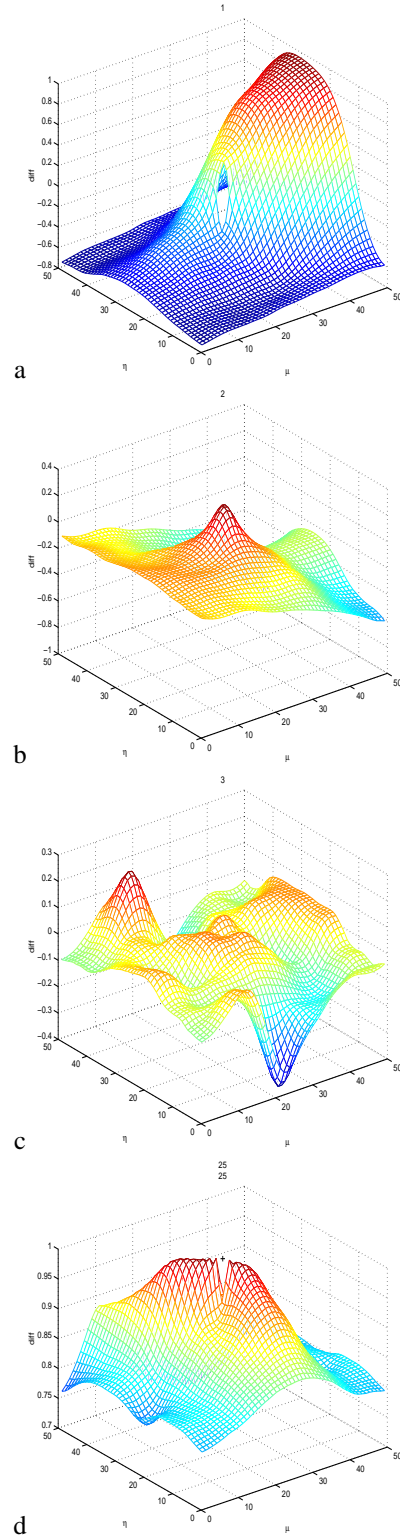

Figure 8: Correlation landscapes.

is calculated:

$$\begin{aligned} \mathbf{p}_i &= \mathbf{f}_{2i} - \mathbf{f}_{2i-1} \\ &= \begin{pmatrix} f_{2i,x} \\ f_{2i,y} \\ f_{2i,z} \end{pmatrix} - \begin{pmatrix} f_{2i-1,x} \\ f_{2i-1,y} \\ f_{2i-1,z} \end{pmatrix}, \forall i = 1 \dots \frac{m}{2} \end{aligned} \quad (15)$$

The vector is then divided by its norm. Further, The components  $x, y$  and  $z$  of the vectors between all electrodes of the belt and the first electrode of the new pair are calculated by:

$$\Delta_{\mu,\eta} = \mathbf{e}_{\mu,\eta} - \mathbf{f}_{m+1}, \quad \mu = 1 \dots L, \eta = 1 \dots C \quad (16)$$

Thus, the first electrode  $f_{m+1}$  of the new pair is selected and all possible vectors for the new pair are available. To find the second electrode of the new pair, one of the possible vectors has to be chosen. The best choice should be the pair with the *largest angle*  $\varphi$  or smallest dot product between the new vector and all the vectors of the pairs already found. For this, the dot product is computed between all possible vectors and the first already found pair. The result is a matrix with as many entries as the total number of electrodes. This matrix is now computed another time for the second pair already found and added to the matrix corresponding to the first pair and so on for all the pairs already found.

$$s_{\mu,\eta} = \sum_i^{m/2} \Delta_{\mu,\eta} \cdot \mathbf{p}_i \quad (17)$$

Now the electrode with the smallest value for this cumulated dot product  $s$  is chosen as second electrode  $f_{m+2}$  of the new pair. The new pair is added to the list of already found pairs and the procedure starts again for the next pair. The result is a set of electrode pairs which cover the belt by their placement and cover the space by their direction.

## 6. PARTICULARITIES OF THE SIGNALS

the hearts are emitting their electric field not homogeneously in all directions. The fields are generated by dipoles with fixed position but changing direction. Thus, regarding only one heart, the signals of two neighbored electrodes are not only of different amplitude but also shifted in time depending on the position of the electrodes. In addition to that the signal is not only shifted but its shape is also changed. Simplifying, it can be described as if the different peaks of the  $P, Q, R, S$  and  $T$  waves have different changes in amplitude for different direction. In other words, by switching from one electrode to a neighbored electrode, the  $Q$  peak could be higher while the  $R$  peaks is lower. Separation could be achieved by finding a function, which describes the relation between signals neighbored pairs and inserting this function in the ICA model. This could be threatened by the fact that not all sources are fields of rotating vectors and by the fact that the properties of the rotation, like speed and direction, heavily depend on anatomical properties as described in [4]. Thus these properties can change between two individuals especially when some kind of anatomical anomalies exist.

## 7. CONCLUSION AND FURTHER WORKS

Several different aspects of sensor selection were discussed. The most important result of this work is not the

algorithm but rather the knowledge gained on the properties of the signals. How the field of the rotating dipole behaves and which questions have to be answered. It came out that the discussion over the best suitable algorithm is closely related to the choice of the hardware. Thus this work did not arrive at the best mean of sensor selection but provides basic information for future researchers.

## REFERENCES

- [1] V. Vigneron, A. Paraschiv-Ionescu, A. Azancot, C. Jutten, and O. Sibony. Fetal electrocardiogram extraction based on non-stationary ICA and wavelet denoising. In *7th IEEE International Symposium on Signal Processing and its applications*, Paris, July 2003.
- [2] V. Zarzoso and A.K. Nandi. Non invasive fetal electrocardiogram extraction: blind separation versus adaptive noise cancellation. *IEEE Trans. Biomed. Eng.*, 48:12–18, 2001.
- [3] F. Vrins, M. Verleysen, and C. Jutten. *Independent Component Analysis and Blind Signal Separation*, volume LNCS 3195 of *Lectures Notes in Computer Science*, chapter Sensor array and electrode selection for non-invasive fetal electrocardiogram. Extraction by independent Component Analysis, pages 1017–1025. Springer, 2004.
- [4] V. Vigneron, A. Azancot, C. Hérail, M. Schmidt, O. Sibony, and C. Jutten. Sensor array for foetal ECG. part 1: Simulations. In *proceeding IEEE CIMED'2005*, 2005.
- [5] V. Vigneron, A. Azancot, A. Sibony, C. Hérail, and C. Jutten. Dispositif matériel et logiciel d'extraction d'ECG foetal. enveloppe Soleau, INPI, 2002.
- [6] A. Borovkov. *Statistique mathématique*. Editions Mir, Moscou, 1987.
- [7] A. Hyvärinen, J. Karhunen, and E. Oja. *Independent Component Analysis*. John Wiley & Sons, Chichester, 2001.