



HAL
open science

A Fine Structure of Finite Projective Ring Lines

Metod Saniga

► **To cite this version:**

| Metod Saniga. A Fine Structure of Finite Projective Ring Lines. 2007. hal-00199008v1

HAL Id: hal-00199008

<https://hal.science/hal-00199008v1>

Preprint submitted on 18 Dec 2007 (v1), last revised 25 Feb 2008 (v2)

HAL is a multi-disciplinary open access archive for the deposit and dissemination of scientific research documents, whether they are published or not. The documents may come from teaching and research institutions in France or abroad, or from public or private research centers.

L'archive ouverte pluridisciplinaire **HAL**, est destinée au dépôt et à la diffusion de documents scientifiques de niveau recherche, publiés ou non, émanant des établissements d'enseignement et de recherche français ou étrangers, des laboratoires publics ou privés.

A FINE STRUCTURE OF FINITE PROJECTIVE RING LINES*

Prolegomena for Quantum Computing,
Besançon (France), November 21–22, 2007

METOD SANIGA

Astronomical Institute of the Slovak Academy of Sciences
SK-05960 Tatranská Lomnica, Slovak Republic
(msaniga@astro.sk)

AN OVERVIEW OF THE TALK

- Introduction
- Basic Definitions and Notation (Free Cyclic Submodule)
- Projective Ring Line
- Visualising the Structure of PRL in Terms of FCSs
- Refinement of the Neighbour Relation
- Existence of “Outliers”
- Outliers Generating FCSs
- Finest Difference Between PLs over Local Commutative Rings
- Possible Physical Applications
- References

*Joint work with **Hans Havlicek** (TUW, Vienna, AT), **Michel Planat** (FEMTO-ST, Besançon, FR) and **Petr Pracna** (JH-Inst, Prague, CZ)

INTRODUCTION

Projective ring lines turned out to be a very important concept in unveiling the intricate geometrical nature of the structure of finite-dimensional Hilbert spaces.

It was our working on these intriguing physical applications when we discovered novel, and rather unexpected, properties of the fine structure of the projective lines not so far discussed by either physicists or mathematicians.

Hence, as the general theory does not exist yet, the purpose of the talk is simply to outline, in a rather illustrative way, the main findings and briefly address their possible applications.

BASIC DEFINITIONS AND NOTATION [1,2]

R : a finite associative ring with unity (1); we shall specifically refer to a ring as being of X/Y type, where X is the cardinality of R and Y the number of its zero-divisors.

$R(a, b)$: a (left) cyclic submodule of R^2 ,
 $R(a, b) = \{(\alpha a, \alpha b) \mid (a, b) \in R^2, \alpha \in R\}$;
a cyclic submodule $R(a, b)$ is called *free* if the mapping $\alpha \mapsto (\alpha a, \alpha b)$ is injective, i. e., if all $(\alpha a, \alpha b)$ are distinct.

Admissibility: a pair/vector $(a, b) \in R^2$ is called admissible, if it is the first row of an invertible 2×2 matrix over R

Unimodularity: a pair/vector $(a, b) \in R^2$ is called unimodular, if there exist $x, y \in R$ such that $ax + by = 1$

For the rings under consideration, admissibility and unimodularity mean the same

PROJECTIVE RING LINE [3–10]

$P(R)$, the projective line over R ,
 $P(R) = \{R(a, b) \subset R^2 \mid (a, b) \text{ admissible}\}$

Crucial property: if (a, b) is admissible, then $R(a, b)$ is free; there, however, are also rings in which there exist free cyclic submodules containing no admissible pairs!

Distant/Neighbour relation: Two distinct points $A =: R(a, b)$ and $B =: R(c, d)$ of $P(R)$ are called distant if the 2×2 matrix with the first row a, b and the second row c, d is invertible; otherwise, they are called neighbour.

It can easily be shown that any two distant points of $P(R)$ have only the pair $(0, 0)$ in common. As this pair lies on any cyclic submodule, the distant/neighbour condition can be rephrased as follows:

Theorem 1: Two distinct points $A =: R(a, b)$ and $B =: R(c, d)$ of $P(R)$ are distant if $|R(a, b) \cap R(c, d)| = 1$ and neighbour if $|R(a, b) \cap R(c, d)| > 1$.

VISUALISING THE STRUCTURE OF PRL IN TERMS OF FCS'S

The structure of $P(R)$ can be visualised in terms of a “tree” comprising all the fcs’s generated by admissible pairs

Any such tree consists of the “corolla” (α being units of R) and the “trunk” (α being zero-divisors of R)

The finest traits of the structure of the line pertain uniquely to the trunk — this fact is already fairly obvious from the examples of projective lines defined over (all) rings of order four (Figure 1)

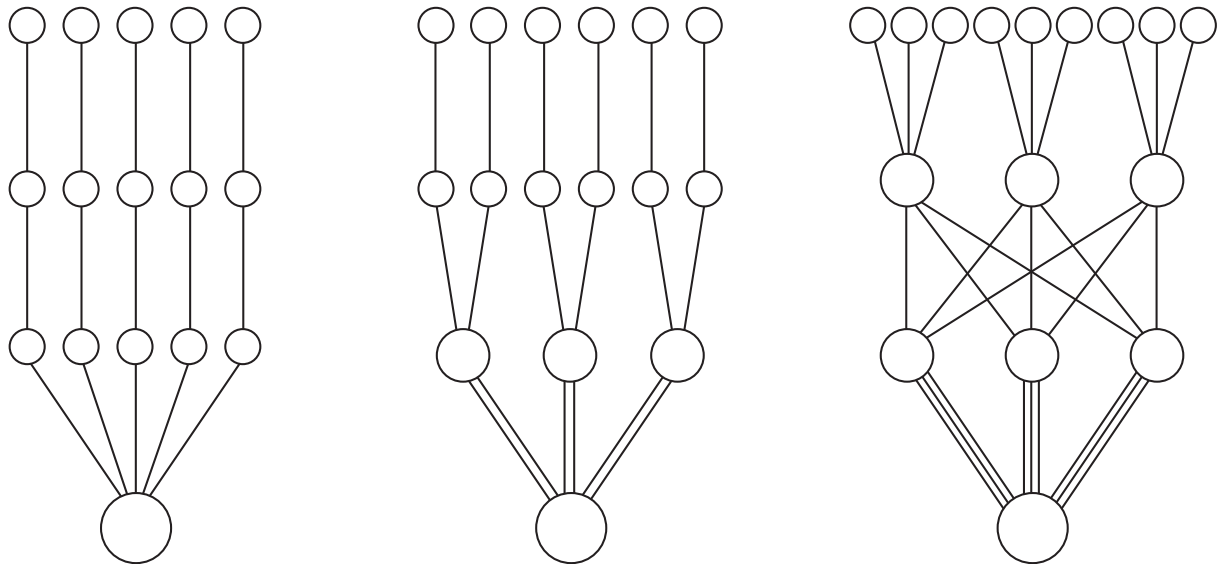

$$\begin{aligned} & \mathbf{GF(2)[x]/\langle x^2+x+1 \rangle} \\ & \cong \\ & \mathbf{GF(4)} \end{aligned}$$

$$\mathbf{GF(2)[x]/\langle x^2 \rangle \text{ or } Z(4)}$$

$$\begin{aligned} & \mathbf{GF(2)[x]/\langle x(x+1) \rangle} \\ & \cong \\ & \mathbf{GF(2) \times GF(2)} \end{aligned}$$

Figure 1:

REFINEMENT OF THE NEIGHBOUR RELATION

From THEOREM 1 it follows that one can refine the neighbour relation by introducing the degree of the “neighbourness” between any two neighbour points in terms of the number of shared pairs/vectors by their representing fcs’s. This is illustrated in Figure 2 on an example of the projective line defined over $Z_{12} \cong Z_3 \times Z_4$.

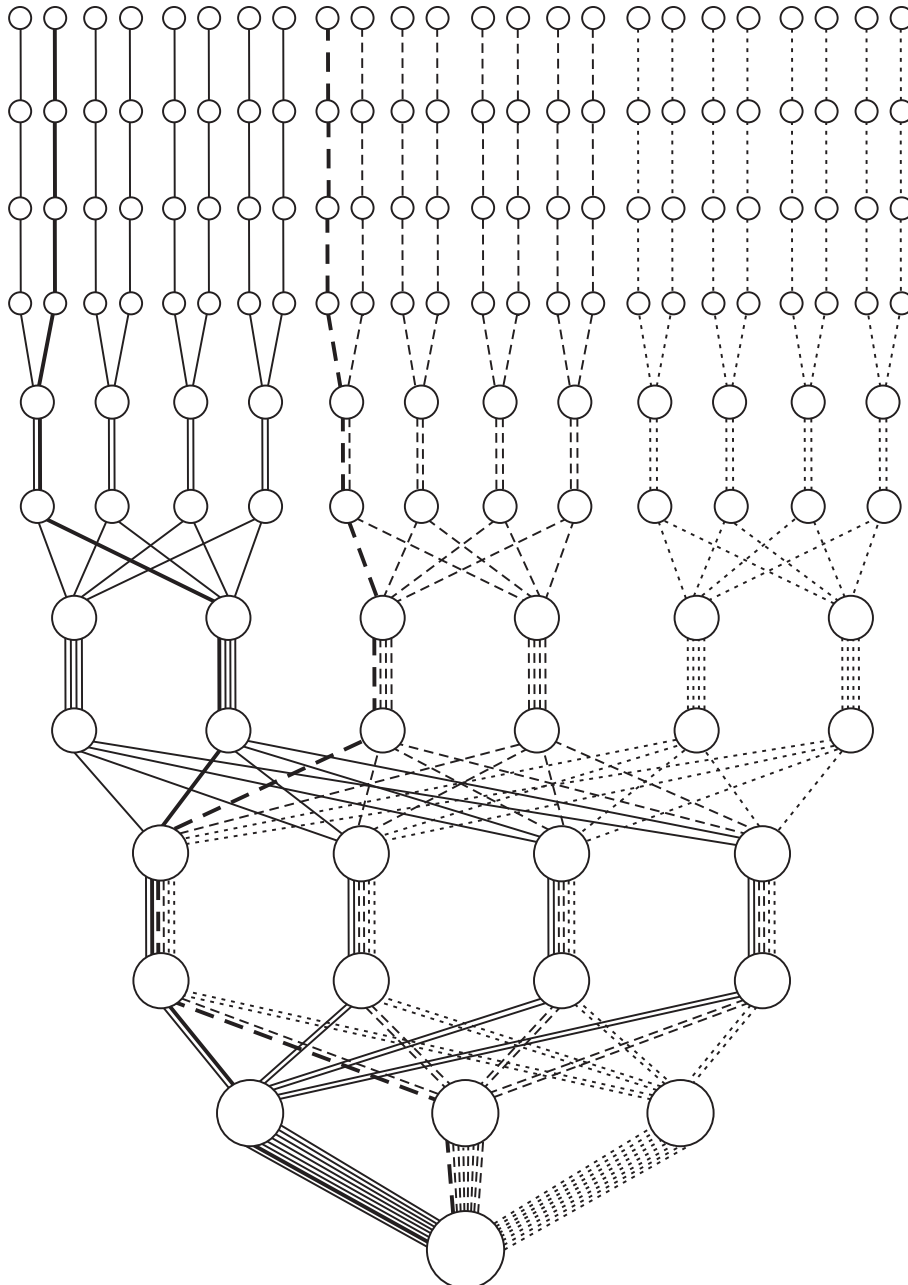

Figure 2:

EXISTENCE OF “OUTLIERS”

Outlier: a pair/vector of R^2 not belonging to any fcs generated by an admissible pair/vector.

Smallest order where they occur are some rings of 8/4 type (Figure 3, right) and the non-commutative 8/6 ring (Figure 4, right); many more are found in the case of commutative 16/8 rings (Figure 5, bottom and top right). Also all non-commutative rings of type 16/8 and 16/12 feature outliers, as well as the non-commutative ring of type 16/14; interestingly, the “exceptional” non-commutative ring of 16/10 type shows no outliers.

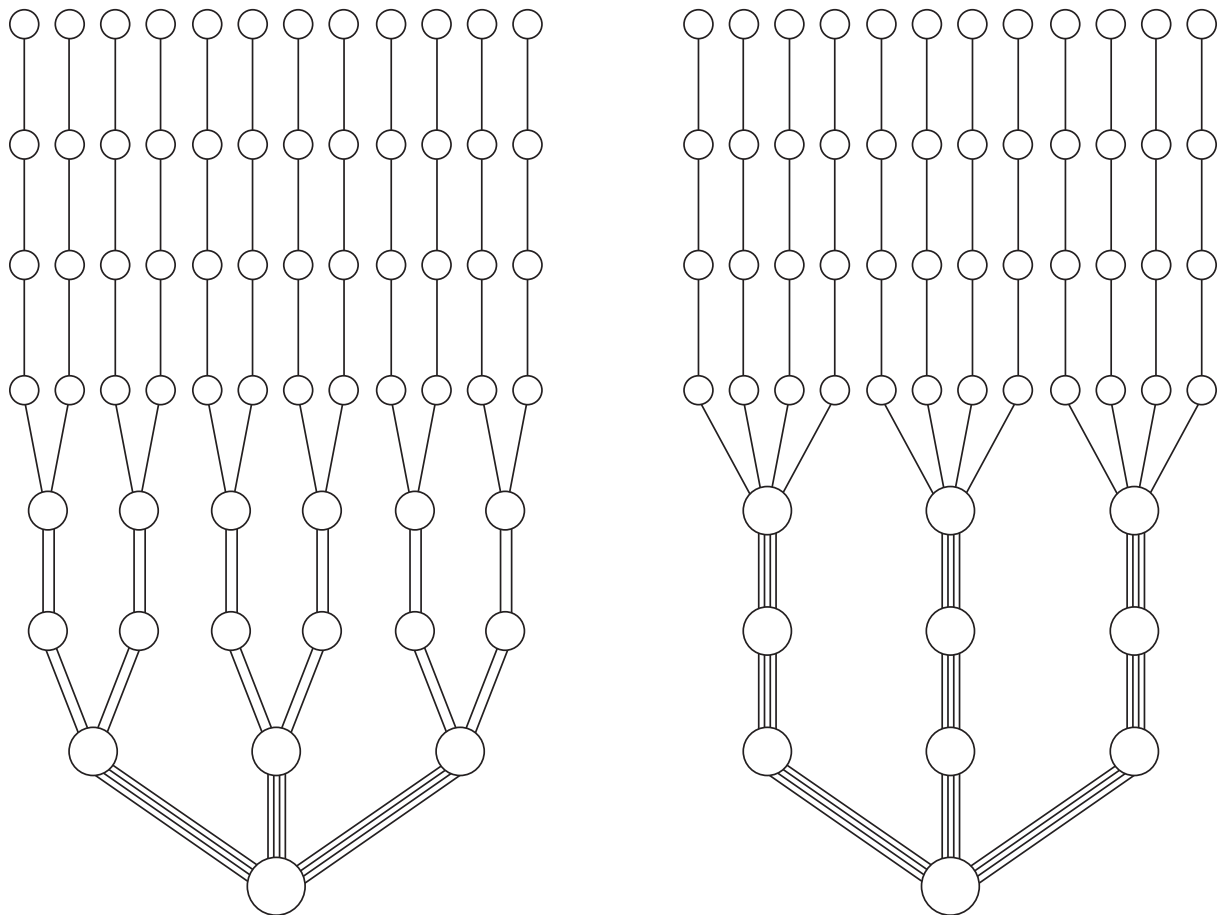

Figure 3:

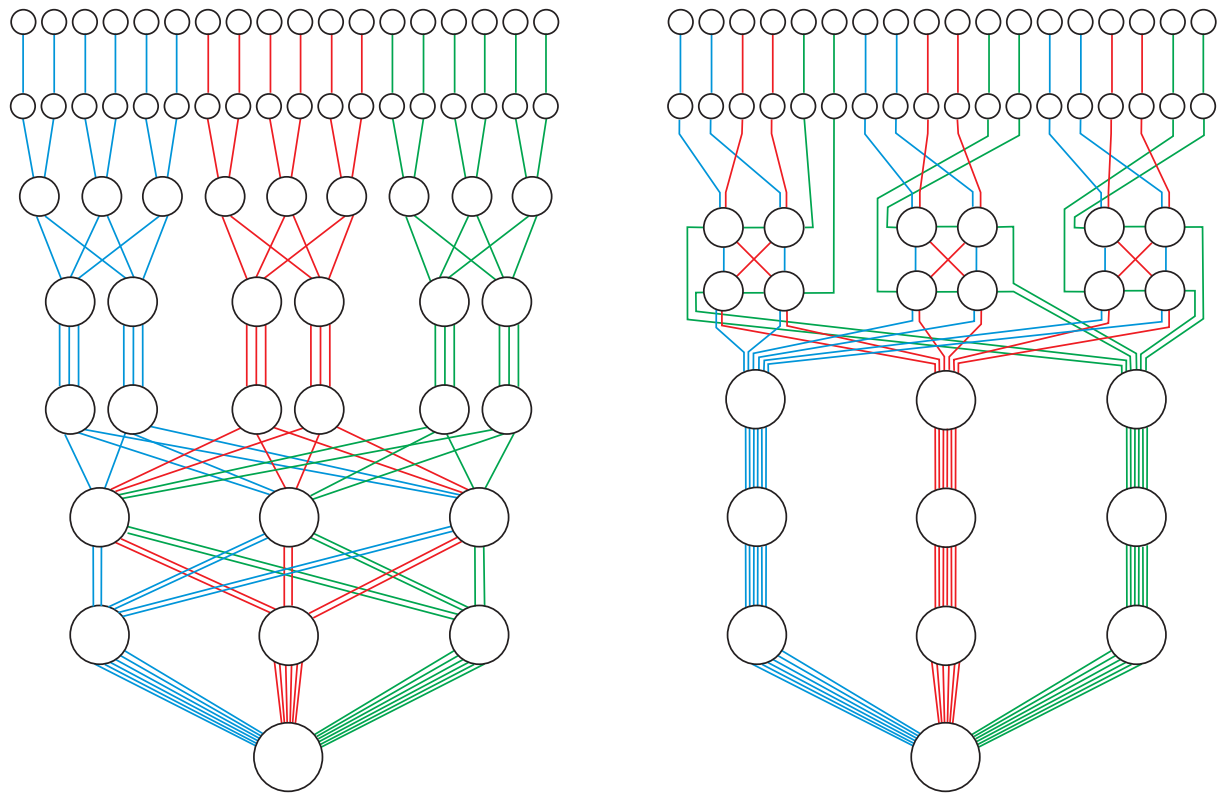

Figure 4:

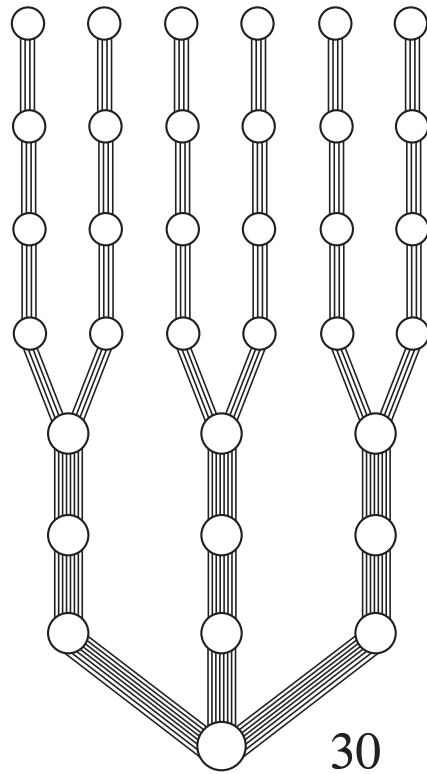
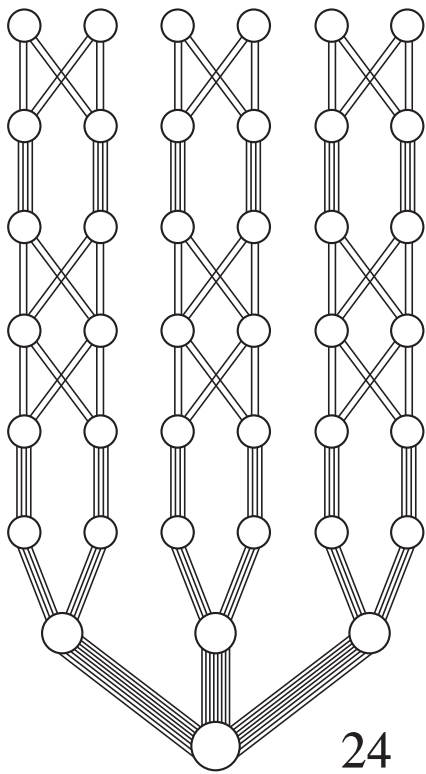
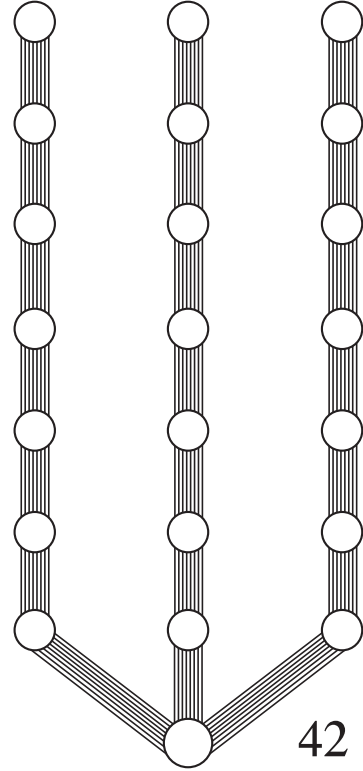
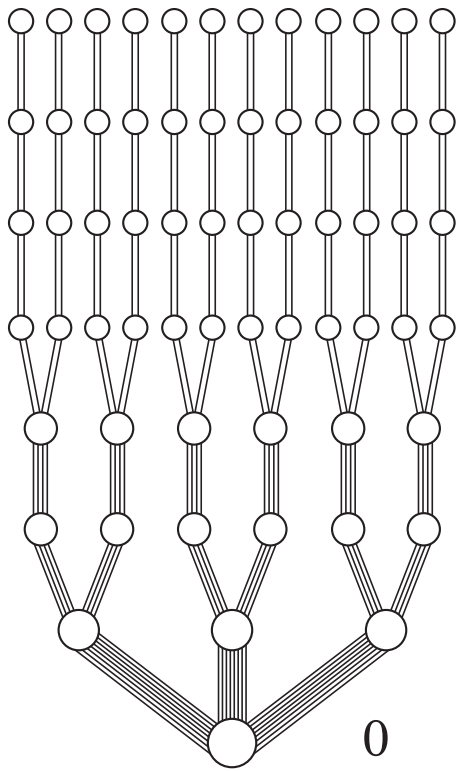

Figure 5:

OUTLIERS GENERATING FCS'S

The smallest order where they appear is 8/6 non-commutative (Figure 6).

They are also found in all but one non-commutative rings of type 16/12 and in the non-commutative ring of type 16/14.

No commutative example has been found among the rings so-far-analyzed.

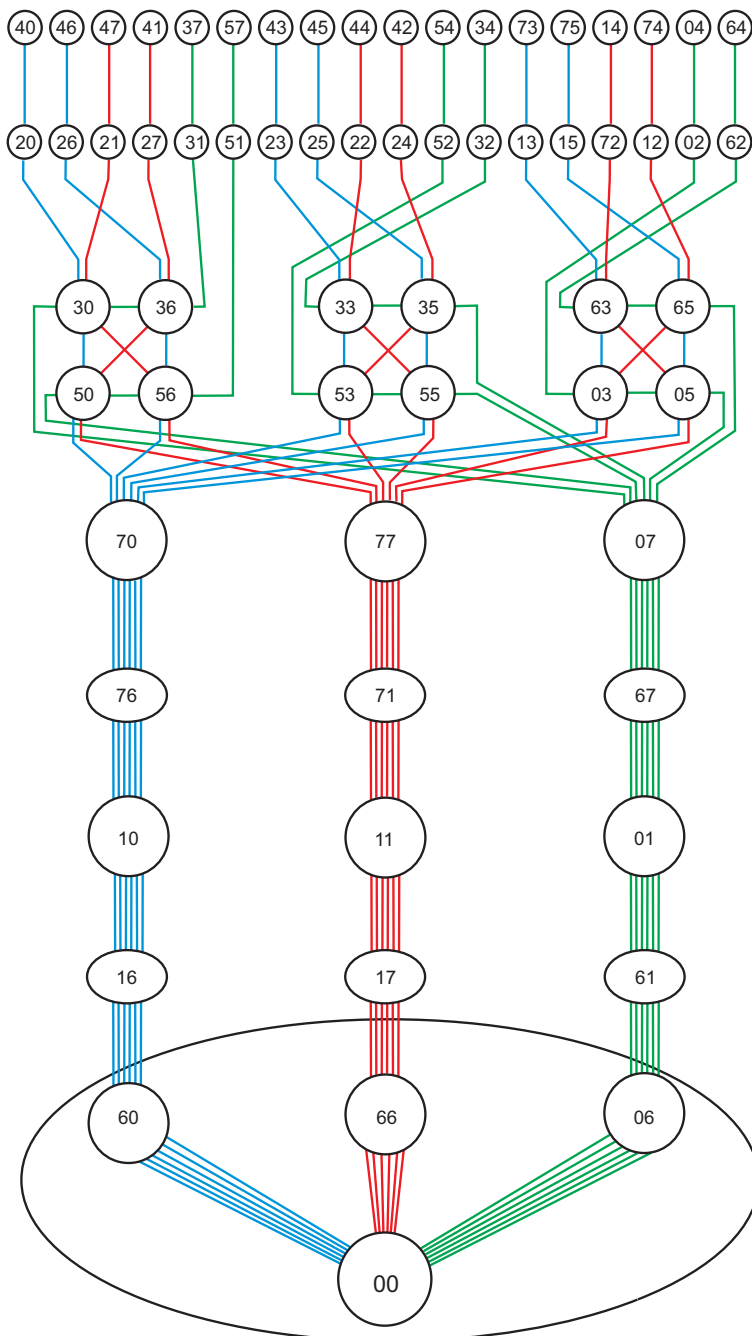

Figure 6:

FINEST DIFFERENCE BETWEEN PL'S OVER LOCAL COMMUTATIVE RINGS

$Z_4 \times Z_4$ versus $Z_2 \times Z_8$:

They are both local of the same (16/12) type and they both feature no outliers; having identical corollas and all “macroscopic” characteristics (total number of points, cardinality of neighbourhoods, intersections of neighbourhoods of two distant points, number of Jacobson points and maximum number of pairwise distant points), they differ profoundly in the “microscopic” structure of their trunks (Figure 7).

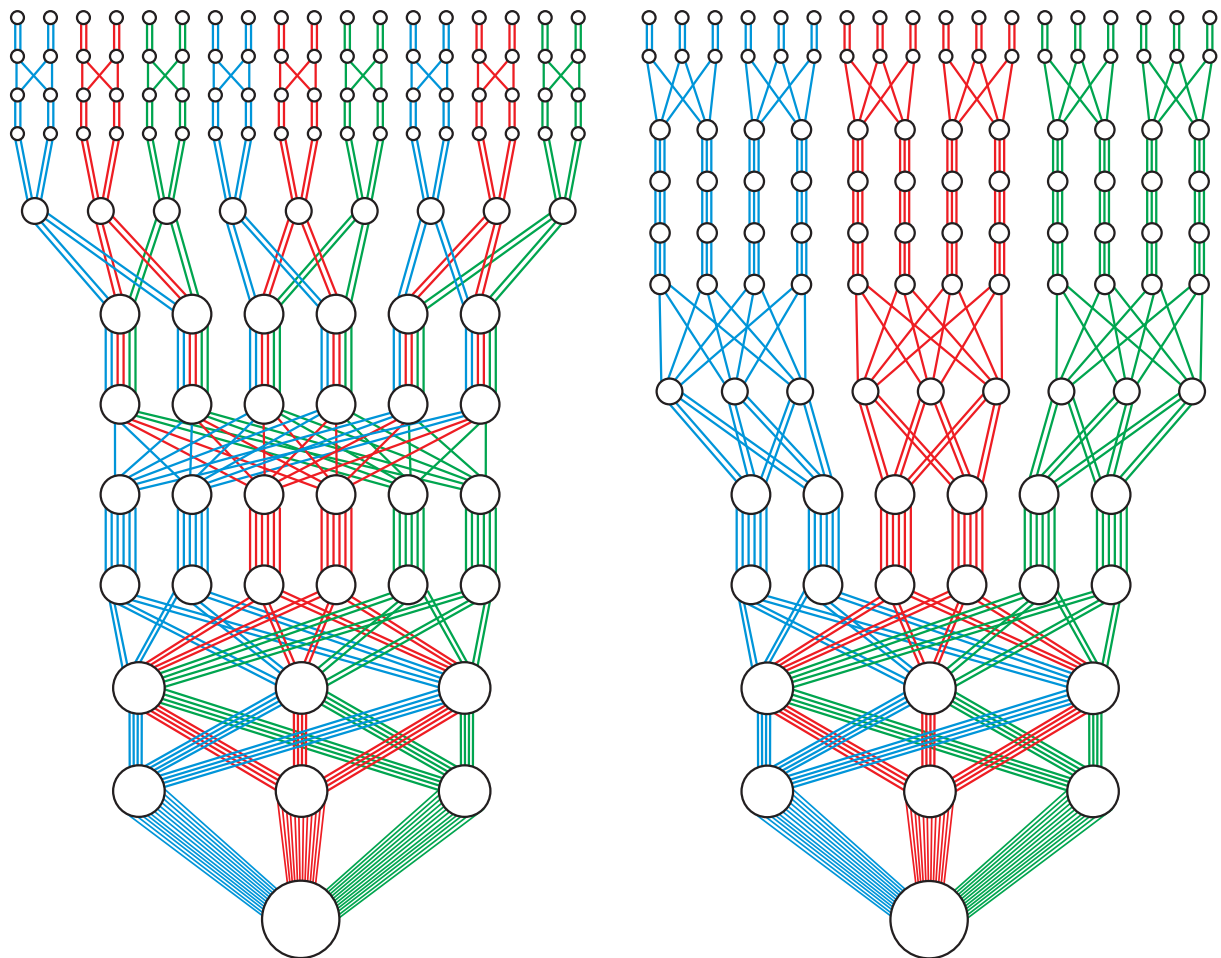

Figure 7:

POSSIBLE PHYSICAL APPLICATIONS

There exists a *bijection* between the pairs/vectors (a, b) of the modular ring Z_d and the elements of the generalized Pauli group of the d -dimensional Hilbert space generated by the standard shift (X) and clock (Z) operators, $\omega^c X^a Z^b$.

Under this correspondence, the operators of the group commuting with a given operator form:

- a) the *set-theoretic* union of the points of the projective line over Z_d which contain a given pair (Figure 8) if d is a product of primes [11], and
- b) the *span* of the points for other values of d [12].

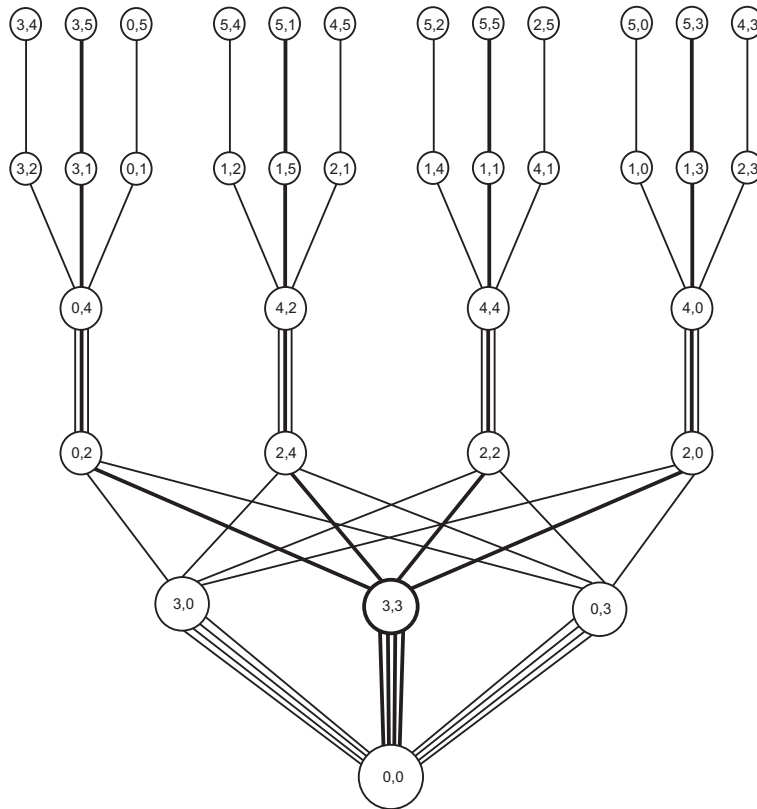

Figure 8:

As yet, there is no general theory for tensorial products of the above-defined operators, but some interesting particular cases have already been computer-analyzed [13].

References

- [1] BR McDonald, Finite rings with identity, Marcel Dekker, New York, 1974.
- [2] R Raghavendran, Finite associative rings, *Comp Mathematica* 1969;21:195–229.
- [3] A Blunck and H Havlicek, Projective representations I: Projective lines over rings, *Abh Math Sem Univ Hamburg* 2000;70:287–299.
- [4] H Havlicek, Divisible designs, Laguerre geometry, and beyond, *Quaderni del Seminario Matematico di Brescia* 2006;11:1–63, available from <http://www.geometrie.tuwien.ac.at/havlicek/pdf/dd-laguerre.pdf>.
- [5] M Saniga, M Planat, MR Kibler and P Pracna, A classification of the projective lines over small rings, *Chaos, Solitons and Fractals* 2007;33:1095–1102.
- [6] A Herzer, Chain geometries, in *Handbook of incidence geometry*, F Buekenhout (ed), Amsterdam, Elsevier, 1995:781–842.
- [7] A Blunck and A Herzer, *Kettengeometrien — Eine Einführung*, Shaker-Verlag, Aachen, 2005.
- [8] M Saniga, M Planat, and P Pracna, A Classification of the Projective Lines over Small Rings II. Non-Commutative Case, math.AG/0606500.
- [9] C Nöbauer, *The Book of the Rings – Part I*, 2000, available from <http://www.algebra.uni-linz.ac.at/~noebsti/pub/rings.ps>.
- [10] C Nöbauer, *The Book of the Rings – Part II*, 2000, available from <http://www.algebra.uni-linz.ac.at/~noebsti/pub/ringsII.ps>.
- [11] H Havlicek and M Saniga, Projective ring line of a specific qudit, *J Phys A: Math Theor* 2007;40:F943–F952
- [12] H Havlicek and M Saniga, Projective ring line of an arbitrary single qudit, *J Phys A: Math Theor* 2008;41:015302 (12pp).
- [13] M Planat and A-C Baboin, Qudits of composite dimension, mutually unbiased bases and projective ring geometry, *J Phys A: Math Theor* 2007;40:F1005–F1012.