



HAL
open science

INVERSE THERMAL PROBLEM VIA MODEL ORDER REDUCTION :DETERMINING MATERIAL PROPERTIES OF A MICROHOTPLATE

T. Bechtold, D. Hohlfeld, E.-B. Rudnyi, H. Zappe, J.-G. Korvink

► **To cite this version:**

T. Bechtold, D. Hohlfeld, E.-B. Rudnyi, H. Zappe, J.-G. Korvink. INVERSE THERMAL PROBLEM VIA MODEL ORDER REDUCTION :DETERMINING MATERIAL PROPERTIES OF A MICROHOTPLATE. THERMINIC 2005, Sep 2005, Belgirate, Lago Maggiore, Italy. pp.126-150. hal-00189467

HAL Id: hal-00189467

<https://hal.science/hal-00189467>

Submitted on 21 Nov 2007

HAL is a multi-disciplinary open access archive for the deposit and dissemination of scientific research documents, whether they are published or not. The documents may come from teaching and research institutions in France or abroad, or from public or private research centers.

L'archive ouverte pluridisciplinaire **HAL**, est destinée au dépôt et à la diffusion de documents scientifiques de niveau recherche, publiés ou non, émanant des établissements d'enseignement et de recherche français ou étrangers, des laboratoires publics ou privés.



Belgirate, Italy, 28-30 September 2005

INVERSE THERMAL PROBLEM VIA MODEL ORDER REDUCTION: DETERMINING MATERIAL PROPERTIES OF A MICROHOTPLATE

Tamara Bechtold, Dennis Hohlfeld, Evgenii B. Rudnyi, Hans Zappe and Jan G. Korvink

IMTEK, University of Freiburg, 79110 Freiburg, Germany, Email: bechtold@imtek.de,

Phone: +49 761 203 7387, Fax: +49 761 203 7382

ABSTRACT

In this paper we present a new possibility to determine unknown material thermal properties based on experimental measurements. We use a parametrized finite element (FE) model and fit it to a measured transient curve. Using brute force, this process requires an extensive computational time. However, it is possible to speed it up significantly by using model order reduction (MOR).

1. INTRODUCTION

An important engineering task is to build a validated model for each characterized novel MEMS device. It is possible to fit an RC-ladder network to the measured results [1], but in this way we don't obtain a complete physical picture of the device. As in most MEMS applications the whole temperature field has to be known, a more detailed FE model is required. Unfortunately, a common problem here is that the material properties of the employed thin film materials, like e. g. thermal conductivity κ and heat capacity c_p , strongly depend on fabrication conditions and may also be specific for the device under the test. In such case, it is possible to extract the material properties by fitting a parametrized FE model to a measured transient curve. However, the conventional optimization process is highly time consuming, because in each iteration a time integration of a full-scale model must be performed (see Fig. 1). As in most MEMS applications the size of an accurate finite element model easily exceeds 100,000 ordinary differential equations (ODEs), we suggest an alternative approach based on model order reduction. The right path in Fig. 1 shows that in each iteration of optimization loop, the suggested approach requires only the time integration of the reduced model (with less than 50 ODEs) and hence brings along an enormous saving in computational time. By defining an objective function, which characterizes the difference between simulated and measured results, data fitting cycle is performed. In this paper we demonstrate that Arnoldi-based model order reduction combined with optimization can be used for the efficient extraction of material thermal properties of a microhotplate. We limit ourselves

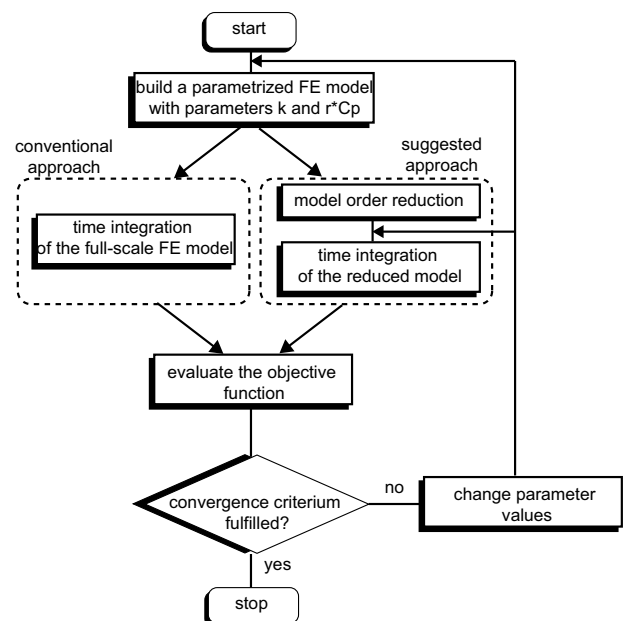

Fig. 1 Parameter extraction process for transient thermal problems via optimization and model order reduction (see also [2]).

to a simplified two dimensional (2D) finite element model with the goal to test the computational environment.

2. MEMS CASE STUDIE - SILICON-BASED MICROHOTPLATE

The fabricated structure resembles a micro-hotplate since it features a membrane for thermal isolation and integrated resistors for heat generation (see Fig. 2). This class of structures is employed in a variety of other micro-fabricated devices such as gas sensors [3] and infrared sources [4], [5].

The membrane features a thin-film metal resistor for temperature modulation through Joule heating. A second resistor, which serves as a temperature sensor, is placed adjacent to the heater. This resistor is configured for a four-point measurement of its resistance. In order to achieve a preferably circular symmetric and homogenous tempera-

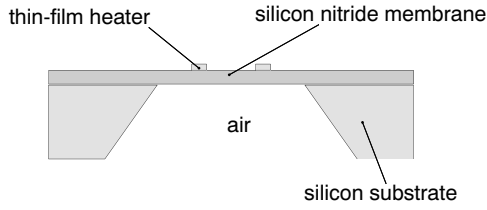

Fig. 2 Microstructured silicon/nitride membrane.

ture distribution at the center of the square membrane, both resistors are arranged as shown in Fig. 3.

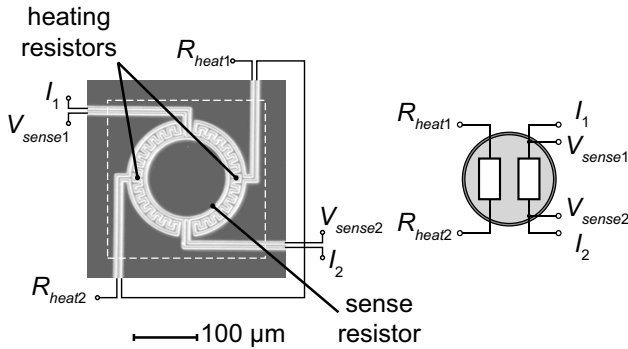

Fig. 3 Schematic view of the thin-film resistors for heating and temperature sensing. Heating resistor is operated at constant voltage. The sensing resistor is configured for four-point measurement.

The characterization of the static and transient thermal properties of the filter membrane is performed on a temperature controlled mount. For characterization of dynamic temperature changes, a constant current of $100\mu A$ is passed through the outer terminals of the sensing resistor while the voltage between the inner terminals is measured using an oscilloscope. In order to use the sensing resistor as a temperature sensor, the linear temperature coefficient of the material's resistivity has to be known. The temperature coefficient is measured by acquiring the sensor's resistance at various temperatures. These are precisely set by the Peltier-mount. The electrical resistance depends linearly on the temperature over the investigated temperature range. This is modeled through:

$$R(\Delta T) = R_0(1 + \alpha\Delta T) \quad (1)$$

with R_0 as the resistance for $\Delta T = 0$. A temperature coefficient of $\alpha = 2.293K^{-1}$ is obtained for a metallization of 150nm platinum with 50nm titanium. The electro-thermal dynamics of the system is determined through the specific heat capacity, material density and thermal conductivity of

the membrane material. Further influences on transient thermal behavior are the geometry parameters, like membrane shape and location of resistors. The transient thermal response of the filter membrane is characterized by applying rectangular heat pulses to the heating resistor using a function generator. The signal output is configured as a voltage source with a fixed output impedance of 50Ω . After applying the heating power, the membrane's temperature increases until a maximum value is reached. This temperature is defined as the steady-state value. After setting the power to zero, the heat stored in the membrane's volume is dissipated to the surrounding media by conduction and free convection. Thus, the temperature drops down to its initial value. The thermal response over a whole period is presented in Fig. 4.

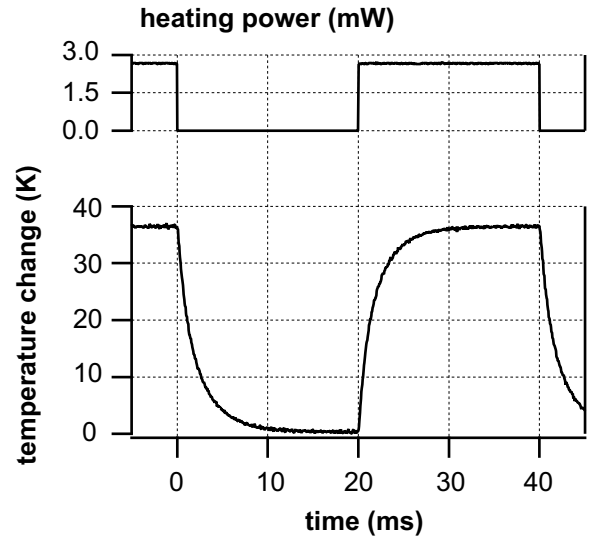

Fig. 4 Temperature modulation of a silicon/nitride membrane. A square wave heating power with a frequency of 25 Hz was applied to the membrane.

As already mentioned, we use a 2D model whose FE mesh is shown in Fig. 5. This simplification requires the omission of both out-of-plane thermal conduction and convection from the membrane's surface. Model contains 4,402 nodes and Dirichlet boundary conditions $T = 0^\circ C$ are set at the outer edges of the simulation domain which results in 4,182 ODEs.

The layer parameters are differentiated into three sections: areas where only the membrane layers are present, sections with the metal thin-films on the membrane and the silicon frame. The material properties are thickness related values, which are calculated as:

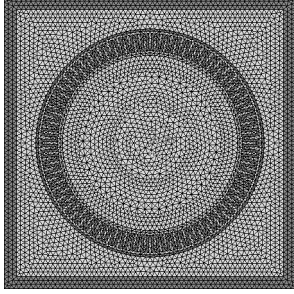

Fig. 5 FE mesh of the 2D model with 4,402 nodes.

$$\kappa'_m = \sum_i \kappa_i d_i, \rho'_m = \sum_i \rho_i d_i, c'_m = \frac{1}{\sum_i \rho_i d_i} \cdot \sum_i c_i \rho_i d_i \quad (2)$$

where d_i is a thickness of each layer and κ_i , ρ_i and c_i are its thermal conductivity, mass density and heat capacity respectively. In order to achieve the consistency between the numerical model and the measurement data, the effective thermal conductivity κ'_m and volumetric heat capacity $c'_m \cdot \rho'_m$ are set as fit parameters in order to determine their actual values via optimization of the reduced model.

3. MODEL ORDER REDUCTION

MOR allows a formal conversion of the physical model, that is, governing partial differential equation to a low-dimensional ordinary differential equation system (see Fig. 1). The intermediate level is a device level, that is, a high

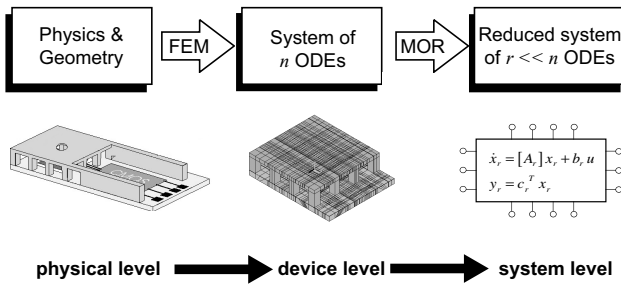

Fig. 6 Place of model order reduction within a conversion process from physical to compact model.

dimensional ODE system. The first conversion of the physical to the device model we perform via the finite element (FE) discretisation. The heat transfer within a hotplate is described through the following equations:

$$\nabla \cdot (\kappa \nabla T) + Q - \rho c \frac{\partial T}{\partial t} = 0, Q = j^2 R \quad (3)$$

where $\kappa(r)$ is the thermal conductivity in W/mK at the position r , $C_p(r)$ is the specific heat capacity in J/kgK, $\rho(r)$ is the mass density in kg/m³, $T(r, t)$ is the temperature distribution and $Q(r, t)$ is the heat generation rate per unit volume in W/m³. Assuming that the heat generation is uniformly distributed within the heater, and that the system matrices are temperature independent around the working point, the finite element based spatial discretization of (3) leads to a large linear ODE system of the form:

$$\begin{aligned} C \cdot \dot{T} + K \cdot T &= F \cdot I^2(t)R(T) \\ y &= E^T \cdot T \end{aligned} \quad (4)$$

where C and K are the global heat capacity and heat conductivity matrices, F is the load vector (matrix) and E is the output vector. (4) is a starting point for model order reduction. As already mentioned for our test case it contains 4,402 ODEs. Software tool mor4ANSYS [6] uses Arnoldi reduction algorithm, which can be viewed as a projection, from the full space to the reduced Krylov-subspace:

$$K_r \{A, b\} = \text{span} \left\{ b, A^2 b, \dots, A^{r-1} b \right\} \quad (5)$$

with $A = -K^{-1}C$ and $b = -K^{-1}F$. This projection is based on the transformation of the state vector T to the vector of generalized coordinates z , subjected to some small error ε :

$$T = V \cdot z + \varepsilon \quad (6)$$

and subsequent left side multiplication of (4) with the V^T . The transformation matrix $V \in R^{n \times r}$, where $r \ll n$ are the dimensions of the reduced and the full system, respectively, is a direct output of Arnoldi algorithm. The property of the Krylov-subspace (5) is such that the transfer function of (4) is approximated through the first r coefficients of its Taylor series around an arbitrary chosen frequency.

Figure 3 in [7] shows the transfer function of the full and reduced order model of a similar microhotplate-based structure, for the expansion around zero. Due to choice of the expansion point we observe a good approximation in the low frequency domain, as can be expected. This corresponds to the good approximation of the steady-state in transient thermal response (shown in Figure 4 in [7]).

Apart from choosing an expansion point, the MOR user must also choose an order for the reduced model which will fulfill the desired accuracy. In [7] we have suggested an error indicator criterion which is based on the convergence of relative error between two reduced models with subsequent order. In case of the microhotplate order 10 has been chosen.

Concerning the saving in computational times due to MOR, it is worth of noting that the time integration of the 2D microhotplate model in ANSYS with 30 time-steps takes 150s, whereas order reduction and the subsequent time integration of the reduced order 10 model in mathematica last only about 2s. However, the writing of files in each time-step by ANSYS, takes up to 50% of integration time for small model sizes. For the higher dimensional models the ratio between ANSYS integration and MOR process is smaller, so that the total saving in computational effort is about 20 times. In [8] we have shown that the time needed for the Arnoldi-based model order reduction of thermal MEMS models is comparable with a single stationary solution of the original system. We use this enormous increase in efficiency to extract material thermal parameters via optimization.

4. OPTIMIZATION

Fig. 7 shows the flexible optimization environment coupled to MOR process. Mathematica is used for scripting,

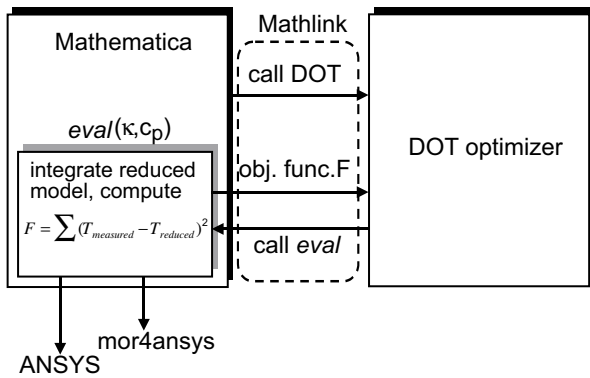

Fig. 7 Implementation of the reduced model optimization.

visualization and small size computations. Its function *eval* takes as arguments the fitting parameters κ and $c \cdot \rho$ and calls the external programs ANSYS (for rebuilding the FE model with changed material properties) and *mor4ansys* (for creating a reduced model). It further integrates the reduced model and evaluates the objective function, which

is defined as a quadratic error between the measured and the computed curves. Its value is transferred back to DOT optimizer [9] which communicates with Mathematica via Mathlink (our implementation can be found at <http://evgenii.rudnyi.ru/soft/dot/>).

Fig. 8 shows the measured temperature response and the simulated temperature response for the reduced order 10 model before the optimization (initial values for the material parameters were chosen as $\kappa = 6.35 W/m \cdot K$ and $\rho \cdot c_p = 525 \cdot 10^5 J/(m^3 \cdot K)$). Fig. 9 shows the measured and the simulated temperature response after 35 cycles of optimization (end values for the material parameters were $\kappa = 5 W/m \cdot K$ and $\rho \cdot c_p = 662 \cdot 10^5 J/(m^3 \cdot K)$).

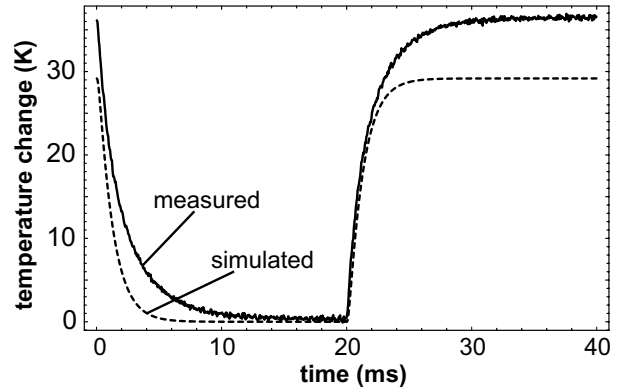

Fig. 8 Measured and simulated temperature response before optimization.

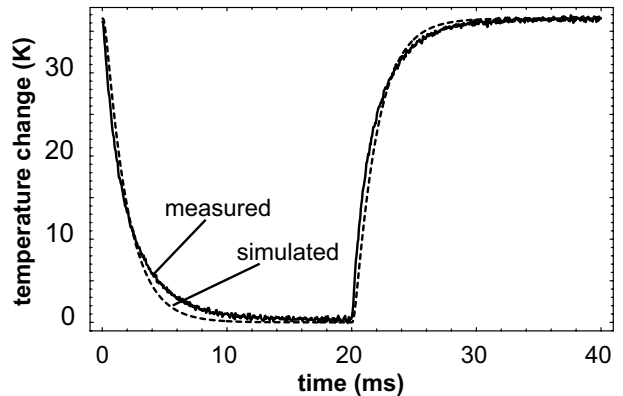

Fig. 9 Measured and simulated temperature response after 35 cycles of simulation.

5. CONCLUSION

We have developed a software environment which can be used for the solution of the inverse thermal problem via model order reduction and optimization. We have applied it to extract material thermal parameters of a fabricated microhotplate. Due to the fact that we have used a simplified 2D model under neglecting out-of-plane thermal conduction and convection and that we have performed optimization with only 2 parameters, the achieved numerical values may not be correct. Nevertheless, we have demonstrated that the tool works in principle. The next step should be to apply it the more realistic 3D model under consideration of convection. It is further possible to change the parameter values at the level of the reduced model [10] (see the right short path in Fig. 1) and to so completely avoid building of a new FE model and subsequent model order reduction.

11. REFERENCES

- [1] V. Székely, M. Renz, "Thermal dynamics and the time constant domain", *IEEE Trans. on Comp. Pack. Techn.*, **23**(3), pp. 587-594, (2000).
- [2] J. S. Han, E. B. Rudnyi, J. G. Korvink, "Efficient optimization of transient dynamic problems in MEMS devices using model order reduction", *J. Micromech. Microeng.*, **15**(4), pp. 822-832, (2005).
- [3] M. Graf, D. Barrettino, S. Taschini, C. Hagleitner, A. Hierlemann, H. Baltes, "Metal oxide-based monolithic complementary metal oxide semiconductor gas sensor microsystem", *Analytical Chemistry*, **76**, pp. 4437-45, (2004).
- [4] R. W. Bernstein, A. Ferber, I. Johansen, S. T. Moe, H. Rogne, and D. T. Wang, "Optical MEMS for infrared gas sensors", *Proc. IEEE/LEOS International Conference on Optical MEMS*, pp. 137-8, (2000).
- [5] A. Pollien, J. Baborowski, N. Ledermann, and P. Muralt, "New material for thin film filament of micromachined hot-plate", *Proc. 11th International Conference on Solid-State Sensors and Actuators*, Munich, Germany, pp. 848-51, (2001).
- [6] E. B. Rudnyi, J. G. Korvink, "mor4ansys (version 1.8): Compact Behavioral Models from ANSYS by Means of Model Order Reduction", at <http://www.imtek.uni-freiburg/simulation/mor4ansys>, (2005).
- [7] T. Bechtold, E. B. Rudnyi, J. G. Korvink, "Error indicators for fully automatic extraction of heat-transfer macromodels for MEMS", *J. Micromech. Microeng.*, **15**(3), pp. 430-440, (2005).
- [8] T. Bechtold, "Model Order Reduction of Electro-Thermal MEMS", *PhD thesis*, University of Freiburg, (2005).
- [9] DOT Users Manual version 4.20 (Colorado Springs, CO: Vanderplaats Research and Development), at <http://www.vrand.com/DOT.html>
- [10] L. H. Feng, E. B. Rudnyi, J. G. Korvink, "Preserving the film coefficient as a parameter in the compact thermal model for fast electro-thermal simulation", *IEEE Transactions on Computer-Aided Design of Integrated Circuits and Systems*, to be published, (2005).