



**HAL**  
open science

## Identifying the Magnetic Part of the Equivalent Circuit of n-Winding Transformers

Xavier Margueron, Jean-Pierre Keradec

► **To cite this version:**

Xavier Margueron, Jean-Pierre Keradec. Identifying the Magnetic Part of the Equivalent Circuit of n-Winding Transformers. IEEE IMTC 05, May 2005, Ottawa, Canada. pp.5320. hal-00182597

**HAL Id: hal-00182597**

**<https://hal.science/hal-00182597>**

Submitted on 13 Feb 2009

**HAL** is a multi-disciplinary open access archive for the deposit and dissemination of scientific research documents, whether they are published or not. The documents may come from teaching and research institutions in France or abroad, or from public or private research centers.

L'archive ouverte pluridisciplinaire **HAL**, est destinée au dépôt et à la diffusion de documents scientifiques de niveau recherche, publiés ou non, émanant des établissements d'enseignement et de recherche français ou étrangers, des laboratoires publics ou privés.

# Identifying the Magnetic Part of the Equivalent Circuit of n-Winding Transformer

Xavier Margueron, Jean Pierre Keradec

Laboratoire d'Electrotechnique de Grenoble  
INPG/UJF UMR-CNRS 5529, ENSIEG, B. P. 46  
38402 Saint-Martin-d'Hères Cedex France

Phone: +33 4 76 82 64 01, Fax: +33 4 76 82 63 00, Email: margueron@leg.ensieg.inpg.fr

**Abstract** – Representation of multi-winding transformers by equivalent circuits has been recently improved and so it is for the identification of its components. In this paper, focus is on magnetic coupling with its related losses. A general method, based on impedance measurements, is used to determinate inductances, coupling ratio and resistances included in these equivalent circuits. Justification for impedance measurements, choice of measured impedances and precautions regarding short-circuit compensation are discussed. For illustration, two components are tested and their equivalent circuits are established.

**Keywords** – multi-winding transformer, equivalent circuit, impedance measurement, identification, short-circuit compensation.

## I. INTRODUCTION

During the last decade, power electronics extended its domain of interest toward low power applications. In converters, wound components (coils and transformers) play a key role: they provide temporary energy storage, voltage transformation and electrical insulation. In medium and low power converters, operating frequencies range from 20 kHz to some MHz, magnetic cores are made of ferrite and, consequently, wound components behave almost linearly. Despite this, these components remain among the most difficult to represent by an equivalent circuit, especially when they own 3, 4 or more windings.

Our team is working on the representation and the experimental characterization of these components for roughly 15 years and successive refinements and extensions [1, 2] have been bring to our first published work on this subject [3]. Recently we introduced a general method to represent the magnetic coupling of an n-winding transformer [4]. Because this coupling is the main property of a transformer, this approach provides the backbone of its equivalent circuit. Our purpose, in this paper, is to show how to deduce this circuit from a set of measurements acquired with an impedance analyzer. We have shown that, putting a linear electrostatic circuit in parallel with the magnetic one allows a large part of its high frequency behavior to be described. For the determination of this part, please refer to [5].

At first sight, it is clear that measuring all the self and mutual inductances leads to the full knowledge of the inductance matrix. Unfortunately this leads to value leakage

inductances with a poor accuracy. Adopting successively two distinct points of view (that of the experimenter and that of the circuit user), we will explain, in the first part, why we prefer impedance measurements to any other kind of measurements to characterize transformers.

In the second part, we first remind the representation of a two winding transformer in order to deepen the localization of leakage inductances. Measurable variations due to the move of these inductances from primary to secondary side are evaluated and a criterion allowing the coupling to be neglected is given. Then, we summarize the method which gives equivalent circuits for n-winding transformers and, finally, we present two special cases that lead to simplifications.

The method intended to experimental identification is presented in the third part on a 150 W, 100 kHz, 3-winding transformer taken as an example. We address questions such as: what impedances to choose in order to fully characterize the magnetic coupling, how to check if non linearity is negligible? We also address some questions relative to the measurement process itself: what care about compensation procedures, how to account for impedances of external short-circuits... Presented experimental results are acquired with a 4294A Agilent impedance analyzer [6].

## II. WHY USING IMPEDANCE MEASUREMENTS?

In order to characterize a transformer, magnetic coupling can be access by different methods, such as inductance matrix evaluation, impedances measurements, s parameters.... How to choose the most appropriate?

First, it must be underlined that impedances measured on a high frequency transformer may range from 1 m $\Omega$  to 1 M $\Omega$ . Even if the frequency range to cover reaches 100 MHz, propagation based measurements are more sensitive when impedances remain relatively close to 50  $\Omega$ . This leads to choose an impedance-gain analyzer rather than a vector analyzer. Moreover, because wiring compensation is more efficient for impedance measurements than for gain measurements, we will try to use only impedance measurements.

Second, inductance matrix may be fully determined by measuring self and mutual inductance. Unfortunately, this approach often leads to a very inaccurate determination of

leakage inductances. Indeed, leakage inductances appear as difference between two terms which are very close from each other (1), especially when coupling is strong (coupling factor  $k_1$  close to 1) [7].

$$L_f = L_{11} - L_{12}^2 / L_{22} = L_{11} - (k_1)^2 L_{11} \quad (1)$$

In switch mode power supplies, transformers are included in electrical circuits in which their windings are periodically connected to load or supplies with extreme impedances ( $R=0$  or  $R \rightarrow \infty$ ). To provide accurate results, the equivalent circuit of the transformer must show, from any of its winding, the right inductance, whatever the number of its short-circuited windings is. As a consequence, our goal is now to identify the equivalent circuit on the base of open circuit and short circuit impedance measurements.

It is easy to show that, if the transformer has N windings,  $N \cdot 2^{N-1}$  such impedances (defined with 0 to N-1 short-circuits) are measurable. Of course, all these impedances are not independent. For example, for any pair of ports of a linear passive circuit, relation (2) applies.

$$Z_0 Z'_{cc} = Z'_0 Z_{cc} \quad (2)$$

$Z$ : Measured from one port,  $Z'$ : Measured from the other port, 0: open circuit measurement,  $cc$ : short circuit measurement.

We will try to select a reduced set of measurable impedances such that, when these impedances are known, all measurable impedances are accurately deducible.

### III. EQUIVALENT CIRCUIT FOR N-INPUT TRANSFORMERS

For a two winding transformer, many representations do exist depending on the localization of leakage inductance. Owing to arbitrary adjustable parameter  $x$ , circuit of fig.1 leads to all of them. In that circuit, leakage inductance is split in two parts; the left one may be attributed to primary, and the right one is to secondary. When  $x = 1$  is chosen, it is interesting to look at the variations of measurable inductances due to the move of magnetizing inductance from center to both left and right positions. It appears that, for  $k > .995$ , inductance variations is within 1%. Reciprocally, when coupling factor is close to unity, leakage splitting does not matter.

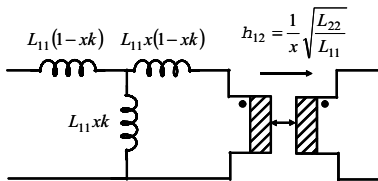

Figure 1 : 2 winding transformer

(1) shows that  $L_{cc} = L_0(1-k^2)$ .

So, if  $k < .1$ , coupling can be neglected because its impact on all measurable inductances is very weak.

Choosing  $x = 1/k$  and transferring series inductance to the secondary side of the coupler, a convenient circuit is drawn that is the first of a series we describe below.

To find the equivalent circuit of a 3-windings transformer, we begin with (fig.2) one inductance (we call magnetizing inductance) and two couplers. These 3 components account for input inductance and for open circuit voltage ratio. Then, we assume left input is shortened. In that situation, the two remaining windings can be looked at as a 2-windings transformer we call leakage transformer (surrounded by dotted line). This approach is iterative: in a 4-winding transformer (fig.3), the leakage transformer is a 3-winding one. Generally, leakage inductances are coupled but, owing to the above criterion, sometime some of these couplings can be neglected. Notice that, assuming inductors are replaced by impedance and couplers can have complex ratio, this way of drawing an equivalent circuit is applicable to any passive linear circuit.

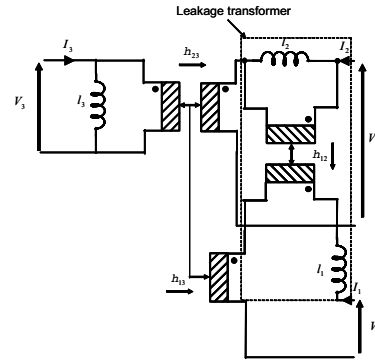

Figure 2 : 3 winding transformer

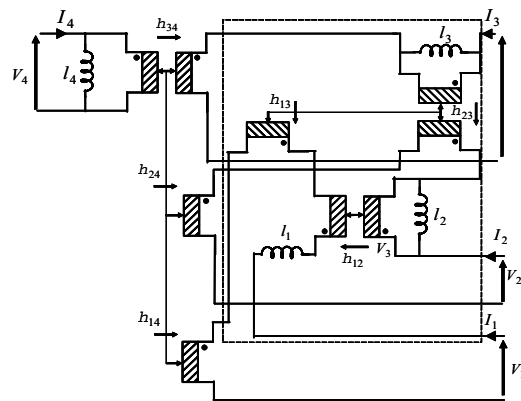

Figure 3 : 4 winding transformer

Despite this approach is general, some particular case are interesting because they lead to simplifications. First of them is identical windings. Windings are identical if they can be exchanged with no impact on electrical behavior. In such a situation, it is easier to look for the circuit of a n-winding transformer by drawing the circuit of an (n-1)-winding one and then splitting one winding in two as shown fig.4 for a 4-winding transformer.

Second case (fig.5) is connected to dominant coupling. Here, it is supposed that two windings are strongly coupled ( $k$  very close to 1) whereas coupling with other windings are smaller. Proposed circuit is presented in fig.5 for a 4-winding transformer, with windings 3 and 4 perfectly coupled. To account for real coupling value between 3 and 4, a leakage inductor must be introduced so it is flown by  $I_3$  or  $I_4$ .

As a conclusion, to find a convenient equivalent circuit, it seems recommended to distinguish two stages. In the first one, every pair of windings is characterized, through open and short circuit measurements. This leads to the full knowledge of the inductance matrix. Looking at this matrix, appropriate simplifications are decided and final representation fixed. The second stage aims at refining some coupling of the leakage transformer. It needs measurement of inductance with, at least, two short-circuits. This need for extra measurements can be justified by the fact that coupling factors of the leakage transformer are deduced from those of the initial transformer through difference of comparable quantities.

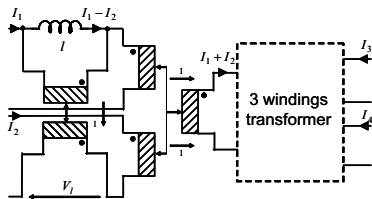

Figure 4 : Equivalent circuit with two identical insulated windings

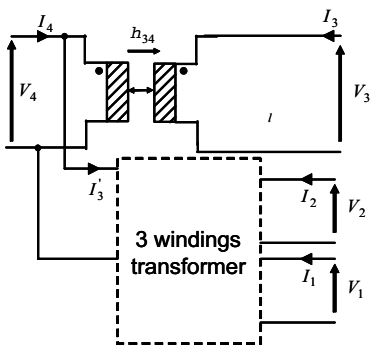

Figure 5 : Equivalent circuit with perfect coupling of two windings

#### IV. EXPERIMENTAL METHOD

As explained above, to characterize an  $n$ -winding transformer, we begin by  $n(n-1)/2$  characterizations of 2-winding couplings. This needs the measurement of the  $n$  open circuit inductances and of  $n(n-1)/2$  inductances with one winding short-circuited. One can see that total number of chosen measurements equals that of independent elements of inductance matrix.

#### A. How to choose the "best measurements" to acquire?

Because we are dealing with the magnetic part of the equivalent circuit that represents the transformer, we focus on the low frequency side of the impedances which roughly ends at the lower resonance frequency. In that frequency range transformer impedances are never too high to be measured accurately but, sometimes, they are too low! For this reason, we choose to first measure all open circuit impedances which are the higher ones. Then, we must measure some impedances with one short-circuit. During these measurements and more generally for low impedance measurements, care must be paid to the short-circuit compensation.

4294A Agilent impedance analyzer [6] measure modulus and argument of an impedance. Each measure performed with this analyzer will thus give complex values.

#### B. Special care to measure low impedances

In fig.6, two methods are compared to realize short circuit compensations. For reproducibility reasons, they both avoid disconnection at the test fixture terminals. The first one overestimates the wire impedance because extra short circuit wire between component terminals is not present during the measurement.

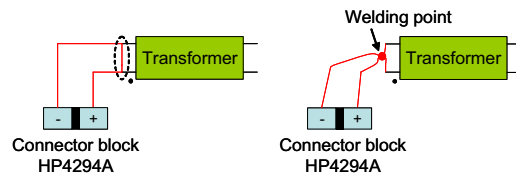

Figure 6 : Compensation method

As a result, this leads sometimes to observe negative resistances (figure 7). Other method leads to opposite results. Wire are soldered close to the component so a little part of each wire is not compensated. This error seems to be less than the previous and above all, found resistances remain positive.

Unfortunately, no systematic procedure is available to account for the impedance of the short-circuit which load a winding. However, redundant measurements allow sometimes its evaluation.

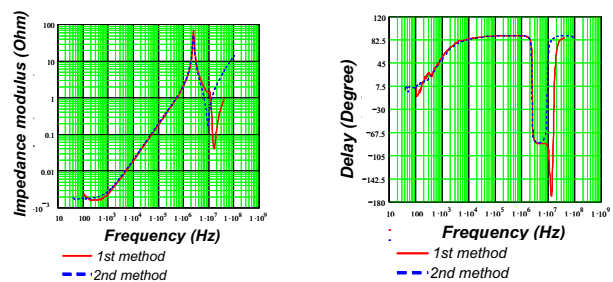

Figure 7 : Compensation method examples

### C. Parameters identification of a pair of windings

During the first stage of the identification, we work on several 2-windings transformers. The equivalent circuit for a 2 winding transformer is presented on figure 8. The circuit relative to the magnetic coupling (which appears in fig.2) is completed by two resistances located in series with both windings. These resistances are supposed to be the dc resistances of each winding wire.

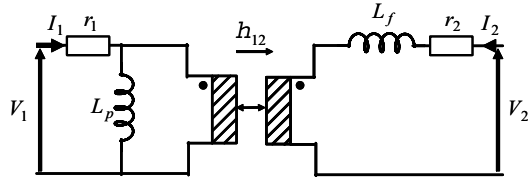

Figure 8 : 2 winding transformer

With open and short circuit configurations, 4 measures (Table I) can be operated.

Table I. Measurement possibilities for a 2 winding transformer.

Measurement	from winding	with
$Z_0$	1	$I_2 = 0$
$Z_{cc}$	1	$V_2 = 0$
$Z'_0$	2	$V_2 = 0$
$Z'_{cc}$	2	$V_1 = 0$

The 2 measures  $Z_0$  and  $Z'_0$  are needed to determinate these DC resistances,  $r_1$  and  $r_2$ . The 2 other available measurements are shorted circuit ones; the fourth are linked by relation (2). Only one more is thus necessary; high impedance measurement will be preferred to lowest one. Because resistance value of a short circuit is not null, relation (2) can be used to found the short circuit impedance value; this one is due to short circuit impedance itself and also contact resistances due to welding.

Previous method [1] [2] evaluated inductances only at one frequency. Open and short circuited inductances where determinate very often at different frequencies. The deduce model was valid for some frequencies, not on a frequency range. To establish the 2 winding model we are now considering that inductances are not perfect inductive components. They are studied as complex impedances (4) (6). In the same way, ratio  $h$  (5) is not supposed to be real.

$$L_p = \frac{\text{Im}(Z_0 - R_0)}{2\pi f} \quad (3)$$

$$h^2 = \frac{Z'_0(Z_0 - Z_{cc})}{(Z_0 - R_0)^2} = \frac{Z_0(Z'_0 - Z'_{cc})}{(Z_0 - R_0)^2} \quad (4)$$

$$L_f = \text{Im} \left[ \frac{Z'_0(Z_{cc} - R_0)}{Z_0 - R_0} \right] \times \frac{1}{2\pi f} \quad (5)$$

To take into consideration some strategy measurement, for example, if  $Z_{cc}$  is preferred to  $Z'_{cc}$ , for the third necessary measure, this one has to be done just after  $Z_0$ . This will

permit to have the same contact resistance which will be compensated by subtraction in (4). Impedance analyser connector can also induce error because of tightening problems. Indeed connexion between connector and round wire is not perfect and it creates a resistor contact, that's why connector has to be screwed hardly.

Figure 9 shows the algorithm which permits to determine the 6 parameters of a 2 winding transformer. If transformer has more than two windings, we work on several 2 windings separately and then we will focus on leakage transformers.

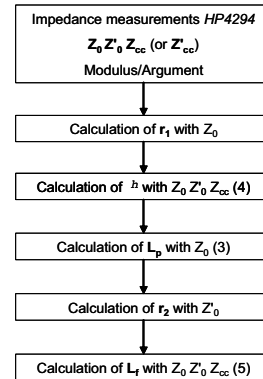

Figure 9 : Algorithm for a 2 winding transformer

2 windings from a 3 winding 100 kHz-150 W transformer wound around a ferrite ring core are now considered. Figure 10 shows curves relative to these two windings. It can be seen that coupling ratio is quite constant and real over 3 decades ( $\Delta f$ ).

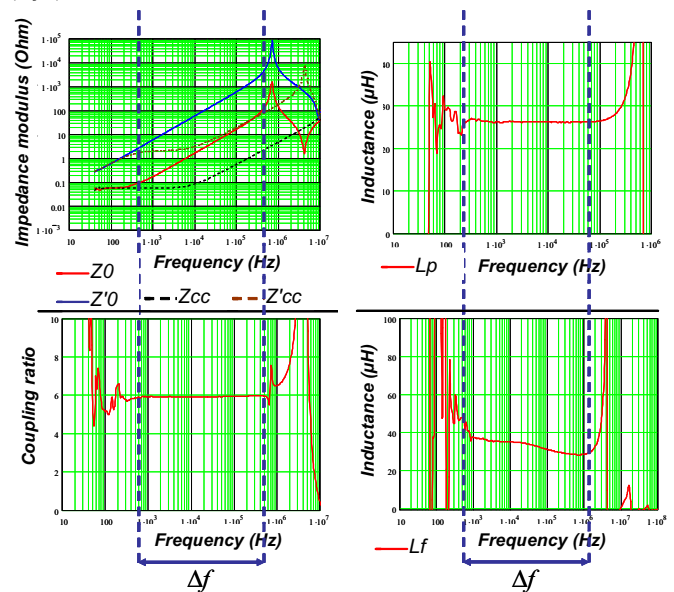

Figure 10 : Identification process for 2 windings from a 3 winding 100 kHz-150 W transformer

Variations on the low frequency side can be attributed to measurement incertitude and high frequency deviation is due to capacitor effects which are not taken into account in this

paper. Magnetizing inductance is also quite constant on  $\Delta f$ , and leakage inductor decreases with the increase of frequency, due to eddy currents effects.

Although previous methods evaluated inductances at one frequency, this one allows their determination on a wide frequency range.

### D. 3 winding Planar transformer

Planar transformers are very interesting ones because many phenomena appear inside these components. The one that we studied has three windings (primary, secondary and auxiliary). Equivalent circuit is presented on figure 2.

Independent 2 windings transformer are first considered. Table II shows the 12 measurement possibilities. Three measures are needed to determine equivalent circuit for primary/secondary transformer. Two more are then necessary for the primary/auxiliary transformer. The last measure will be useful for determining leakage transformer between secondary and auxiliary. 6 measures are thus necessary, 3 with open circuits, 2 with one short circuit and 1 with two short circuits.

Table II. Measurement possibilities for a 3 winding transformer.

Measurement	from winding	with	
$Z_{1\_2o\_3o}$	1	$I_2 = 0, I_3 = 0$	0 short circuit
$Z_{2\_1o\_3o}$	2	$I_1 = 0, I_3 = 0$	
$Z_{3\_1o\_2o}$	3	$I_1 = 0, I_2 = 0$	
$Z_{1\_2cc\_3o}$	1	$V_2 = 0, I_3 = 0$	1 short circuit
$Z_{1\_2o\_3cc}$	1	$I_2 = 0, V_3 = 0$	
$Z_{2\_1cc\_3o}$	2	$V_1 = 0, I_3 = 0$	
$Z_{2\_1o\_3cc}$	2	$I_1 = 0, V_3 = 0$	
$Z_{3\_1cc\_2o}$	3	$V_1 = 0, I_2 = 0$	2 shorts circuits
$Z_{3\_1o\_2cc}$	3	$I_1 = 0, V_2 = 0$	
$Z_{1\_2cc\_3cc}$	1	$V_2 = 0, V_3 = 0$	
$Z_{2\_1cc\_3cc}$	2	$V_1 = 0, V_3 = 0$	
$Z_{3\_1cc\_2cc}$	3	$V_1 = 0, V_2 = 0$	

Coupling ratios (figure 11) are first calculated with (4). For this transformer, measurements from secondary are very difficult because of the low level of impedance (0.5 m $\Omega$ ). Imprecision on these measurements at low frequencies induce imprecision on expressions (3) (4) and (5). This can explain the shape of coupling ratio between 100Hz and 1kHz. A better connector and wire compensation is needed like on figure 6.

Coupling ratios are quite constant and real between 1kHz and 1MHz. Above this frequency, capacitors have to be taken into account.

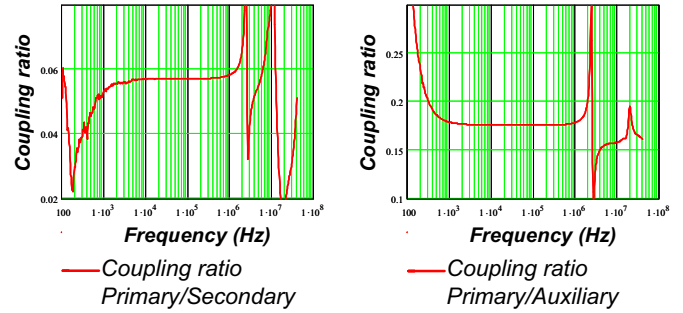

Figure 11 : Primary/Secondary and Primary/Auxiliary coupling ratios

One of the particularities of this transformer is that all inductances decrease with the increase of frequency. Even magnetizing inductance is not constant with frequency. This variation can be represented by figure 12. At low frequency inductance is equal to  $L_{BF} = L_{HF} + \Delta L$ . For higher frequencies, equivalent inductance is simply equal to  $L_{HF}$ . This model is quite simple but the addition of several cells permits to fit the variation.

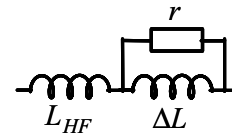

Figure 12 : Inductance variation representation

Inductances calculated with (3) and (5) are presented with their model (dotted line) on figure 13.

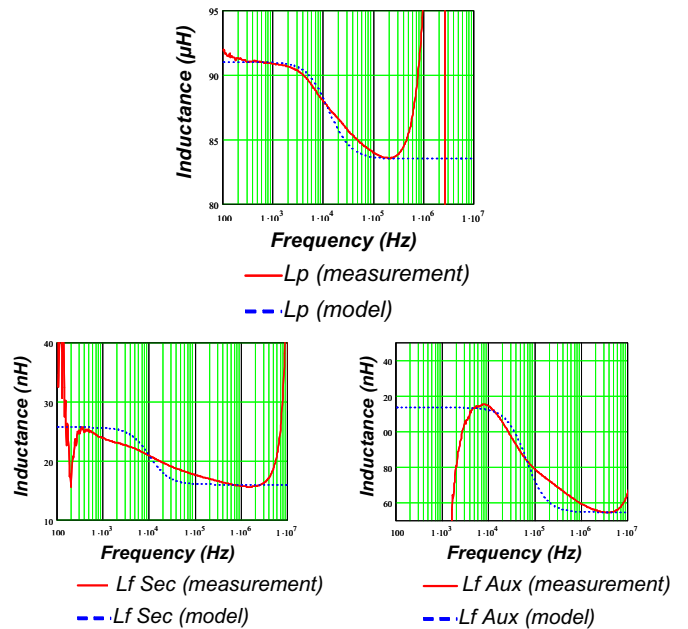

Figure 13 : Magnetizing and leakage inductances

For leakages inductances, it is difficult to determine them with good accuracy below 500Hz for secondary and 10kHz

for auxiliary. At these frequencies, resistors are predominating compared to inductances.

To determinate leakage coupling between secondary and auxiliary, a measurement with two short circuits is needed. Because of low impedance from secondary, the one from auxiliary will be preferred. Figure 14 shows that coupling between these 2 windings is low and it can be neglected. Leakage coupler is not necessary.

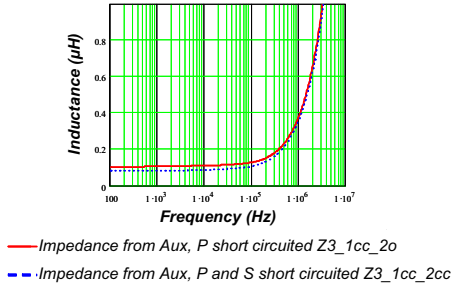

Figure 14 : Influence of leakage coupling

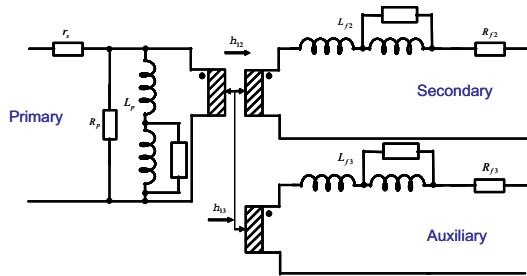

Figure 15 : 3 winding planar transformer equivalent circuit

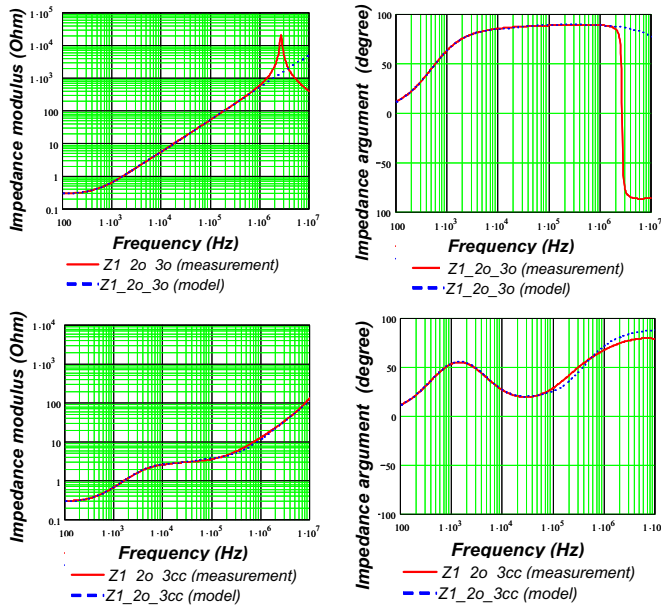

Figure 16 : Comparisons between measurement and model simulation

Inductive model of the transformer is presented on figure 15. Comparisons between measure and Psice® simulation on figure 16 show good agreement between our model and the planar transformer. Only two configurations are presented, one with no short circuit and one with one short circuit.

The inductive model is now validated. Capacitor effects have now to be taken into account to characterize totally the transformer.

## V. CONCLUSION

Experimental characterisation of multi-winding transformers is now mature. Theoretical developments have given reliable general equivalent circuits. This paper presents a general method intended to the experimental identification of these equivalent circuits.

Accuracy target has been clearly enunciated according to users needs and measured impedances have been chosen to reach this target. Indispensable precautions to use the impedance analyzer at best are also described and checked. Results relative to a ring core transformer and to a planar one, both having three windings, have been given.

## REFERENCES

- [1] J. P. KERADEC, A. SCHELLMANN, J. L. SCHANEN, K. BERROUCHE. "Representing electrical behaviour of transformers by lumped element circuits. A global physical approach.", *IEEE Industrial Application Society*, Phoenix, Arizona (U. S. A. ), 3-7 Oct. 1999, pp. 2100-2107. IEEE Reference.
- [2] A. SCHELLMANN, K. BERROUCHE, J. P. KERADEC, "Multiwinding transformers: a successive refinement method to characterize a general equivalent circuit.", *IEEE Instrumentation Measurements and Technology Conference*, St Paul, Minesota (U. S. A.), 18-20 May 1998, Proc. pp. 717-722.
- [3] B. COGITORE, J. P. KERADEC, J. BARBAROUX. "Two winding ferrite core transformer : An experimental method to obtain a wide frequency range equivalent circuit". *IEEE Transactions on Instrumentation and Measurements*, April 1994, vol. 43, no. 2, pp. 364-371.
- [4] X. MARGUERON, J. P. KERADEC, "Design of equivalent circuits and Characterization strategy for n-input coupled inductors", *IEEE Industrial Application Society*, oct. 2004, Seattle (Wa) USA. CD proceeding 15p1.
- [5] A. SCHELLMANN, J. P. KERADEC, J. L. SCHANEN, "Electrical equivalent circuit for frequency dependant impedance: minimum lumped elements for a given precision." *IEEE Industrial Application Society*, Rome (It), 3-7 Oct. 2000.
- [6] Agilent 4294A Precision Impedance Analyser-Operation Manual, Agilent Technologies.
- [7] *Magnetic Circuits and Transformers*, Chapter XVII, Art. 5, pp 454, by the EE Staff at MIT, McGraw-Hill, New York, 1943.