



HAL
open science

A prediction-based nonlinear controller for stabilization of a non-minimum phase PVTOL aircraft

Ahmed Chemori, Nicolas Marchand

► **To cite this version:**

Ahmed Chemori, Nicolas Marchand. A prediction-based nonlinear controller for stabilization of a non-minimum phase PVTOL aircraft. *International Journal of Robust and Nonlinear Control*, 2008, *Nonlinear Model Predictive Control of Fast Systems*, 18 (8), pp.876-889. 10.1002/rnc.1248 . hal-00176071

HAL Id: hal-00176071

<https://hal.science/hal-00176071>

Submitted on 27 Mar 2023

HAL is a multi-disciplinary open access archive for the deposit and dissemination of scientific research documents, whether they are published or not. The documents may come from teaching and research institutions in France or abroad, or from public or private research centers.

L'archive ouverte pluridisciplinaire **HAL**, est destinée au dépôt et à la diffusion de documents scientifiques de niveau recherche, publiés ou non, émanant des établissements d'enseignement et de recherche français ou étrangers, des laboratoires publics ou privés.

A prediction-based nonlinear controller for stabilization of a non-minimum phase PVTOL aircraft

A. Chemori^{1,*†} and N. Marchand²

¹*LIRMM, Univ. Montpellier 2-CNRS, 161 rue Ada, 34392 Montpellier Cedex 05, France*

²*LAG-UMR 5528-ENSIEG BP 46, 38402 Saint Martin d'Heres Cedex, France*

SUMMARY

In this paper, a nonlinear prediction-based control approach is proposed for stabilization of planar vertical take-off and landing (PVTOL) aircraft. This system has fewer control inputs than degrees of freedom (i.e. under-actuated) and has unstable zero dynamics (i.e. non-minimum phase). The proposed control approach is based on partial feedback linearization, which allows the emergence of a completely linearized sub-state and internal dynamics. Then, optimal trajectories are proposed for the linearized variables, where the optimization objective is to enhance the behaviour and the stability of the internal dynamics. Stability analysis of the closed-loop system is performed using a graphical tool based on Poincaré's section. The performance of the proposed scheme is illustrated through simulations. Copyright © 2007 John Wiley & Sons, Ltd.

KEY WORDS: PVTOL aircraft; non-minimum phase; internal dynamics; nonlinear predictive control; stabilization; robustness

1. INTRODUCTION

Vertical take-off and landing (VTOL) describes flying machines that can lift off and land up vertically. This class of machines includes helicopters, balloons and few aircrafts. PVTOL aircrafts have the same property but projected in the plane. One example of real PVTOL aircrafts is the AV-8B Harrier manufactured by McDonnell Douglas company, displayed in Figure 1.

† E-mail: ahmed.chemori@lirmm.fr



Figure 1. Example of PVTOL aircrafts : AV-8B Harrier.

The simplified PVTOL is a mathematical model of flying aircraft that evolves in the vertical plane with three degrees of freedom. These coordinates correspond to its position and orientation in the frontal plane. However, this system is equipped with only two thrusters that produce a force and a moment on the flying machine.

PVTOL stabilization represents a challenging and a very interesting nonlinear control problem since it includes difficulties such as under-actuation and non-minimum phase features. Consequently, it gains more and more interest within the control community. In the last few years, many control strategies have been proposed to control the simplified PVTOL aircraft, which has a minimum number of states, but that retains the main features that must be considered when designing controls for a real aircraft.

The existing works can be subdivided into two main classes: the first one addresses the trajectory tracking problem, whereas the second one aims to solve the stabilization problem. The first set of results dealing with trajectory tracking is chronologically earlier. Hauser *et al.* [1] proposed an approximate input–output linearization, which results in bounded tracking (and stabilization) for the V/STOL. This approach was then extended by Martin *et al.* [2] with a flat output approach. In contrast to the approximate linearization proposed by Hauser, Martin’s approach enables to take into account non-minimum phase flat systems as well as a non-zero coupling parameter. A multirate digital approach was initially proposed in [3] and then further extended. It is worth emphasizing that these works assume that the rolling angle remains within the interval $]-\pi/2, \pi/2[$.

The efforts brought to achieve global stabilization are, however, more recent. In [4], taking first the rolling angle directly as control and after a coordinates change, the system is transformed to a double integrator chain. Using a result of [5], this first subsystem is stabilized with a positive and bounded thrust. A tracking strategy is then used to force the roll angle to converge to the trajectory required to stabilize the first sub-system. This strategy that initially enabled only bounded thrust was extended in [6] to take care also of a bounded angular acceleration. It should be emphasized that the result obtained is global contrary to most preceding results. Besides this important work, a robust stabilization can be found in [7]. The robust stabilization objective is formulated as an optimal control problem. The obtained Hamilton–Jacobi–Bellman (HJB) problem can then be explicitly solved for a particular parametrization of the controller, based on a transformation that often appears in the trajectory tracking framework, assumes that the rolling angle remains in the strict positive half-plane $]-\pi/2, \pi/2[$. Furthermore, a small displacement assumption is made on the angle θ in order to simplify the HJB problem formulation.

In this paper, a recently developed control scheme in [8] is exploited to control the PVTOL aircraft. Simulation results are given to show the efficiency of the proposed control approach.

The paper is structured as follows: In Section 2, the PVTOL aircraft is described and its dynamic model is given. Section 3 is devoted to partial feedback linearization of the dynamic model. In Section 4, the proposed feedback controller is summarized. Stability analysis of the resulting closed-loop system is discussed in Section 5. Section 6 reports on simulation results, and the paper ends with a conclusion.

2. DESCRIPTION AND DYNAMICS OF THE PVTOL AIRCRAFT

Consider the nonlinear simplified dynamics of the PVTOL aircraft initially proposed in [9], and widely used since:

$$\ddot{x} = -\sin(\theta)u_1 + \varepsilon \cos(\theta)u_2 \quad (1)$$

$$\ddot{y} = \cos(\theta)u_1 + \varepsilon \sin(\theta)u_2 - 1 \quad (2)$$

$$\ddot{\theta} = u_2 \quad (3)$$

where x and y represent, respectively, the horizontal and vertical position of the aircraft's centre of mass as shown in Figure 2. θ is the roll angle that the aircraft makes with the horizon. The control inputs u_1 and u_2 represent the normalized quantities related to the vertical thrust directed upwards with respect to the aircraft and the angular acceleration (rolling moment). The PVTOL aircraft belongs to the so-called *under-actuated* class of systems, since it has a fewer number of control inputs than degrees of freedom. The parameter ε is a coefficient which characterizes the coupling between the rolling moment and the lateral acceleration of the aircraft. For usual aircrafts, this parameter is small but on recent applications like unmanned air vehicles (UAV) or flapping robots, this parameter may have a non-negligible influence. The coefficient '-1' in Equation (2) corresponds to the normalized gravitational acceleration. These different parameters are better illustrated in Figure 2.

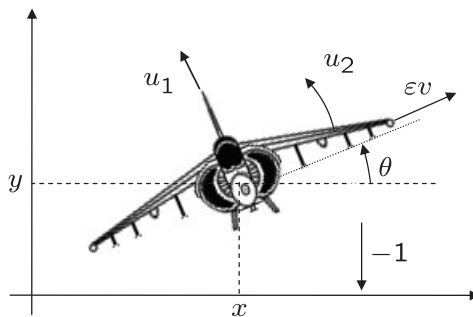

Figure 2. View of the PVTOL aircraft in the frontal plane.

3. FEEDBACK LINEARIZATION

Consider the simplified dynamics (1)–(3) of the PVTOL aircraft, and the two outputs:

$$\begin{aligned} y_1 &= x \\ y_2 &= y \end{aligned} \tag{4}$$

Let us now derive the outputs until at least one of the control inputs appears. The two outputs derived twice give:

$$\begin{bmatrix} \ddot{x} \\ \ddot{y} \end{bmatrix} = \begin{bmatrix} 0 \\ -1 \end{bmatrix} + D \begin{bmatrix} u_1 \\ u_2 \end{bmatrix} \tag{5}$$

where the matrix D given by

$$D = \begin{bmatrix} -\sin(\theta) & \varepsilon \cos(\theta) \\ \cos(\theta) & \varepsilon \sin(\theta) \end{bmatrix}$$

is called the decoupling matrix, which is non-singular since $\det(D) = -\varepsilon$.

Remark

In the case where $\varepsilon = 0$, there exists a bijective coordinate transformation that brings the dynamics with $\varepsilon = 0$ to dynamics (1)–(3) with $\varepsilon \neq 0$ [10]. Then, even though $\varepsilon = 0$, with this transformation the decoupling matrix is always non-singular.

Consider now the control inputs chosen as:

$$\begin{bmatrix} u_1 \\ u_2 \end{bmatrix} = D^{-1} \left(\begin{bmatrix} v_1 \\ v_2 \end{bmatrix} + \begin{bmatrix} 0 \\ 1 \end{bmatrix} \right) \tag{6}$$

which can be rewritten as:

$$\begin{aligned} u_1 &= -\sin(\theta)v_1 + \cos(\theta)(1 + v_2) \\ u_2 &= \frac{1}{\varepsilon}\cos(\theta)v_1 + \frac{1}{\varepsilon}\sin(\theta)(1 + v_2) \end{aligned} \tag{7}$$

These controls injected in dynamics (1)–(3) lead to the following partial linearized system:

$$\ddot{x} = v_1 \tag{8}$$

$$\ddot{y} = v_2 \tag{9}$$

$$\ddot{\theta} = \frac{1}{\varepsilon}(\sin(\theta) + \cos(\theta)v_1 + \sin(\theta)v_2) \tag{10}$$

which could be written in the standard form of partially linearized systems [11]:

$$\dot{\zeta} = A\zeta + Bv, \quad \zeta \in \mathbb{R}^{n_\zeta} \tag{11}$$

$$\dot{\eta} = Z(\zeta, \eta), \quad \eta \in \mathbb{R}^{n_\eta} \quad (12)$$

with $\zeta = [x \ \dot{x} \ y \ \dot{y}]^T$, $\eta = [\theta \ \dot{\theta}]^T$, $n_\zeta = 4$, $n_\eta = 2$.

The completely linearized part is controllable, since the controllability matrix $\mathcal{C}(A, B)$ is full rank. Equation (12) defines what we call the internal dynamics [11, 12] of the PVTOL system. Since this dynamics is unstable, then the system is called *non-minimum phase* [1].

4. THE PREDICTION-BASED FEEDBACK CONTROLLER

The control approach proposed to control the PVTOL aircraft is developed in [8] for systems with jumps, whose dynamics writes:

$$\dot{x} = f(x) + g(x)u \quad \text{if } x \notin \mathcal{S}_0 \quad (13)$$

$$x(t^+) = \Delta(x(t)) \quad \text{if } x \in \mathcal{S}_0 \quad (14)$$

where $x \in \mathbb{R}^n$ and $u \in \mathbb{R}^m$ are the state and the control input, respectively, f , g and Δ are continuous functions in their arguments. Equation (14) defines a conditional jump on the state, which occurs when its trajectory under (13) hits the switching surface defined by

$$\mathcal{S}_0 := \{x \in \mathbb{R}^n \mid S(x) = 0\}$$

where $S : \mathbb{R}^n \rightarrow \mathbb{R}^{n_s}$ is some continuous map.

The proposed approach is also applicable to classical jump-free nonlinear systems, insofar as any classical n -dimensional jump-free system (13) may be extended to $(n+1)$ -dimensional system (13) and (14) with virtual jump. This is stated in the following lemma (the proof of this lemma can be found in [8]).

Lemma 1

Any classical n -dimensional jump-free system $\dot{x} = f(x) + g(x)u$ may be embedded in an $(n+1)$ -dimensional system that has the general form (13)–(14).

In this section, the basic principle of the control approach is summarized, and the forthcoming section is devoted to the stability analysis of the resulting closed-loop system. Roughly speaking, the basic idea of the proposed nonlinear predictive control scheme is to use the completely linearized sub-state ζ to enhance the stability of the internal dynamics η . Model (13)–(14) should be put in the form (11)–(12) by means of a partial feedback linearization. The basic structure of the proposed scheme is shown in Figure 3.

The prediction model block uses a state space model of the system to predict future states and especially internal dynamics. The optimization block is a fundamental part of the proposed strategy, it provides optimal parameters (cf. (15)) of reference trajectories on linearly controlled sub-state ζ . The aim of the optimization is to enhance the stability and behaviour of internal dynamics of the system. The parameterized trajectories block uses optimal parameters to construct reference trajectories $\zeta_d = [x_d \ \dot{x}_d \ y_d \ \dot{y}_d]^T$ on linearly controlled sub-state ζ . These trajectories are tracked using a PD-like feedback controller (cf. (17)). The algorithm of the proposed scheme basically consists of the following steps.

Step 1: Definition of B-spline p -parameterized trajectories on the directly controlled variables ζ (cf. Figure 4). These trajectories should link the two points ζ^0, ζ^f in the space \mathbb{R}^ζ . ζ^0 is the initial sub-state, and ζ^f ($= 0$ for stabilization) is the desired final one. The sampling time is denoted by T , and the virtual jumps are τ_c -equispaced, that is, $t_k = k\tau_c$. The decision instants over each interval $[t_k, t_{k+1}]$ are defined by $\tau_k^j = t_k + j(\tau_c/m)$; $j = 0, \dots, m-1$, where m is a design parameter which denotes the number of times that the optimal trajectories are updated between each two successive virtual jumps (for the PVTOL aircraft this parameter is fixed to $m = 2$, cf. Simulations later on).

Step 2: Computation of the optimal parameter p based on a prediction of the internal dynamics, this is done by optimization of the following performance index:

$$\hat{p}_k := \text{Arg min}_{p \in \mathcal{P}} \|\eta(t_{k+1}^-) - \eta^f\|_Q^2 \quad (15)$$

where η^f defines some desired sub-state on the internal dynamics, which may be chosen, for stabilization purpose, as $\eta^f = 0$ and Q is a weighting matrix. $\eta(t_{k+1}^-)$ is the state of the internal dynamics just before next jump, it is obtained by means of prediction.

The optimization parameter \hat{p}_k is that invoked in step 1, it parameterizes the reference trajectories. It is chosen scalar in order to reduce the computation time. In doing so, the proposed control approach could easily be implemented for fast systems control.

$\eta(t_{k+1}^-)$ that appears in (15) can be expressed by the following relation:

$$\eta(t_{k+1}^-) = F(\eta(t_k^-), p_k, \zeta^f) \quad (16)$$

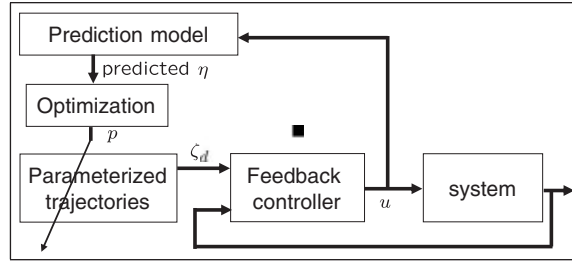

Figure 3. The control approach principle.

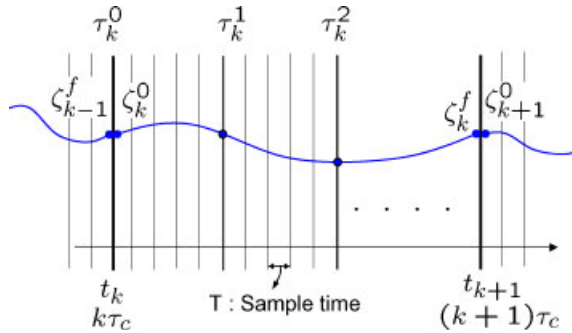

Figure 4. Trajectories illustration.

F is a prediction function of the internal dynamics over the interval $[t_k, t_{k+1}]$. The times t_k^- and t_{k+1}^- that appear in relations (15) and (16) represent instants just before the virtual jumps t_k, t_{k+1} , respectively.

Step 3: Tracking of the optimal reference trajectories is done until next decision instant τ_k^{j+1} using the following feedback:

$$\begin{aligned} v_1 &= \ddot{x}_d + k_d(\dot{x}_d - \dot{x}) + k_p(x_d - x) \\ v_2 &= \ddot{y}_d + k'_d(\dot{y}_d - \dot{y}) + k'_p(y_d - y) \end{aligned} \quad (17)$$

where the subscript d denotes the reference trajectory, k_d, k_p, k'_d, k'_p are positive feedback gains. The proposed feedback corresponds to a PD-type controller for double integrator. Then, consider the actual state of the system as initial state and go to step 1.

These three steps of the algorithm are to be executed at each decision instant τ_k^j . Even though the second step includes an optimization problem to resolve, a real time application of the approach is possible, since the computation time is significantly reduced with respect to classical MPC [13] approach (cf. Simulations).

5. STABILITY ANALYSIS

The stability of the closed-loop system (composed of completely linearized part and internal dynamics) depends on the stability of the internal dynamics under the chosen time varying feedback. To do that, the graphical tool based on Poincaré's section developed in [8] is used. The basic idea of this method is explained by the following equations.

Equation (16) injected in (15) leads to the following dynamics:

$$\begin{aligned} \eta(t_{k+1}^-) &= F(\eta(t_k^-), \hat{p}_k(\eta(t_k^-), \zeta^f, \eta^f), \zeta^f) \\ &= F_{cl}(\eta(t_k^-), \zeta^f, \eta^f) \end{aligned} \quad (18)$$

this dynamics can be expressed in multi-step form (k_0 steps ahead) by k_0 successive compositions as:

$$\eta(t_{k+k_0}^-) = F_{cl}^{k_0}(\eta(t_k^-), \zeta^f, \eta^f)$$

then the following multi-step function is to be plotted for increasing values of $r = \|\eta - \eta^f\|_Q^2$:

$$\Psi_{k_0}^Q(r) := \left[\sup_{\|\eta - \eta^f\|_Q^2 = r} \|F_{cl}^{k_0}(\eta, \zeta^f, \eta^f) - \eta^f\|_Q^2 \right] \quad (19)$$

According to the obtained curve, two cases are possible. In the first case, illustrated in Figure 5, a convergence to stable limit cycle is obtained for any initial condition within the region of attraction delimited by the second intersection point of the curve with the bisector. In the case of stabilization, the limit cycle should degenerate to a point in the phase portrait of the internal dynamics.

In the second case, illustrated in Figure 6, a convergence to an ε -neighbourhood of a stable limit cycle is obtained for any initial condition within the region of attraction, delimited by the second intersection point of the curve with the bisector.

It is worth noting that the proposed graphical tool, besides stability analysis, also enables estimation of a region of attraction. The reader should refer to [14, 15] for more details on contraction property.

For the PVTOL aircraft, the stability analysis falls in the first case (cf. Section 6, especially Figure 7).

6. SIMULATION RESULTS

Consider the PVTOL aircraft dynamic model (1)–(3) with the coupling parameter $\varepsilon = 0.5$, the different parameters of the proposed control approach are summarized in Table I.

Two simulation case studies are proposed in the sequel. In the first simulation, the objective is to stabilize the PVTOL aircraft to the equilibrium. The second one aims to show the robustness of the proposed control strategy against parameters uncertainties.

6.1. Stabilization control

In this simulation, the stabilization problem of the PVTOL aircraft is considered from the initial condition defined by $x_0 = [1 \ 1 \ 30 \ 0.2 \ -0.5 \ 20]^T$ and the final target sub-state is chosen as

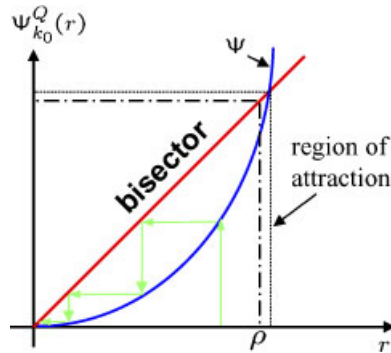

Figure 5. Stability analysis tool: convergence to a stable limit cycle.

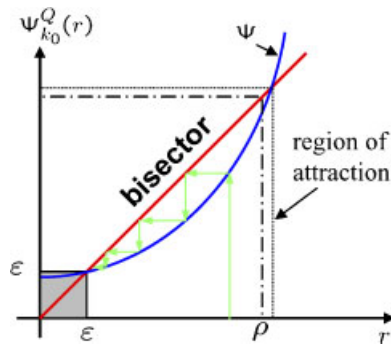

Figure 6. Stability analysis tool: ε convergence to a neighbourhood of a stable limit cycle.

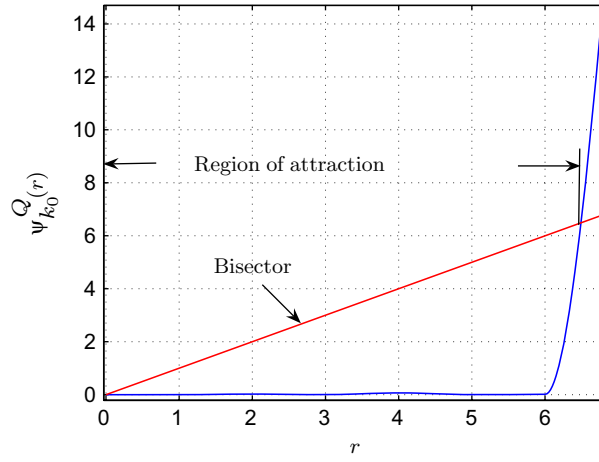

Figure 7. A stability analysis tool: the curve $\Psi_{k_0}^Q(r)$ for $k_0 = 5$.

Table I. Control approach parameters.

Parameter	Significance	Value
t_f	The horizon length	1.85 s
Q	Weighting matrix	$\begin{pmatrix} 1 & 0 \\ 0 & 0.3 \end{pmatrix}$
p	Optimization parameter	$x(t_f/4)$
m	Trajectories updates	2

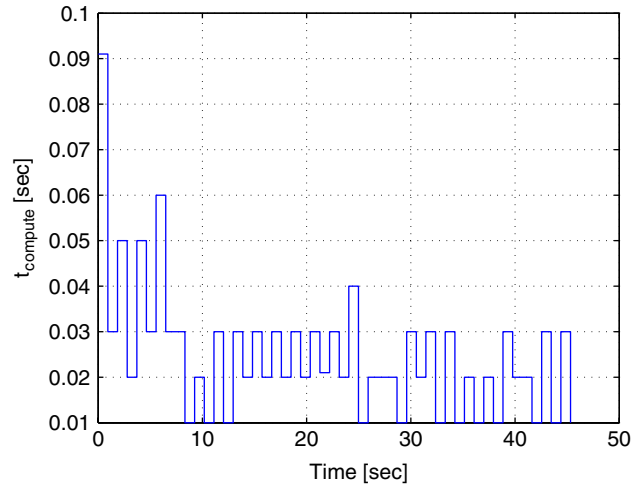

Figure 8. Evaluation of computing time.

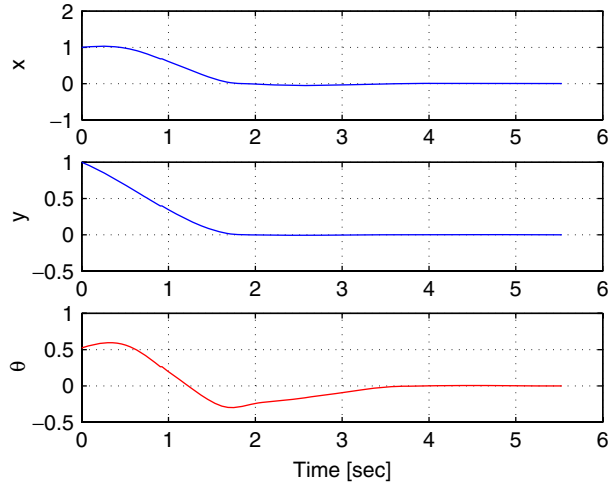

Figure 9. Evolution of the PVTOL position and orientation.

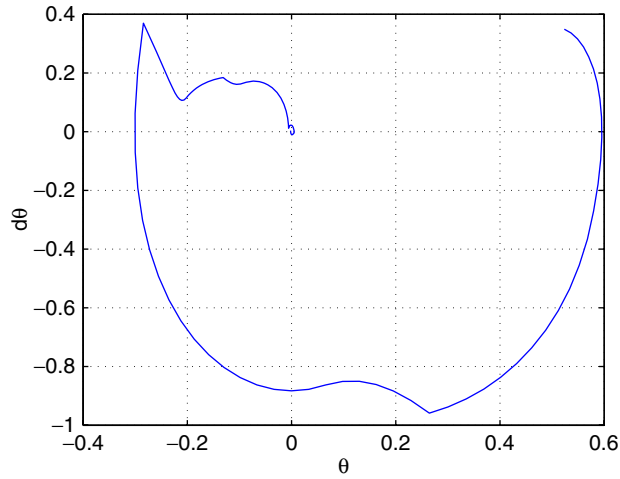

Figure 10. Phase portrait of internal dynamics.

$\zeta^f = 0, \eta^f = 0$. The optimal trajectories on the directly controlled variables are updated twice over each interval $[t_k, t_{k+1}]$, that is, $m = 2$.

6.1.1. Stability analysis and computing time. The stability analysis of the closed-loop system is carried out using the graphical tool discussed in Section 5. Figure 7 displays the multi-step function $\Psi_{k_0}^Q$. According to the obtained curve, the sufficient conditions of point 1 of Proposition 1 (cf. [8]) are satisfied for $k_0 = 5$.

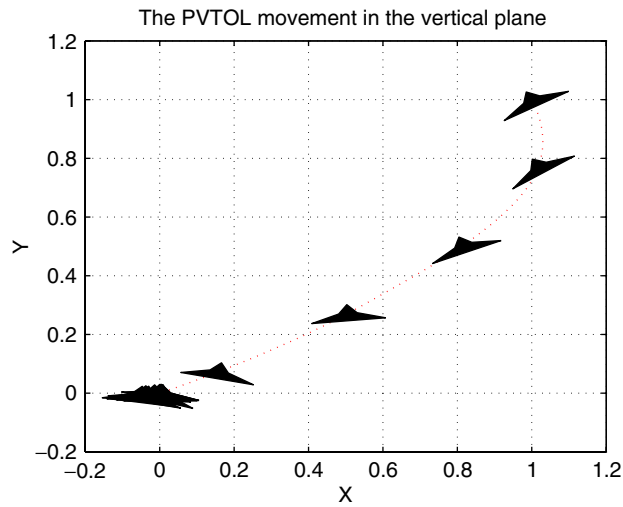

Figure 11. Stick figures of the PVTOL in the vertical plane.

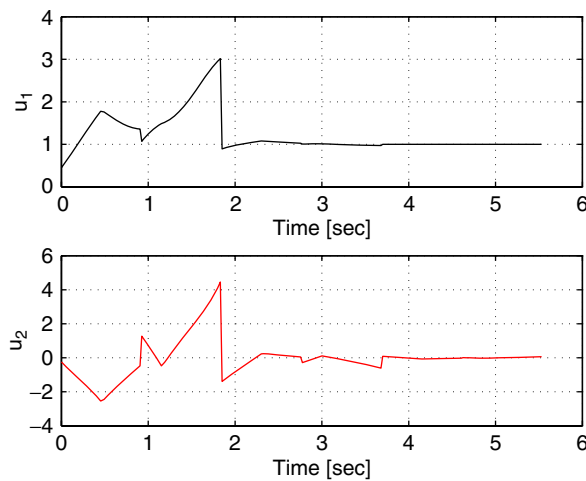

Figure 12. Evolution of the control inputs.

The simulations are carried out on a Visual Fortran 5.0 framework. To evaluate the computing time[‡] the function TIMEF from the IMSL library is used. For that, the controlled system is simulated (starting from the above initial condition) for 45 s and the obtained curve is plotted in Figure 8. The maximum computing time is $t_{\max} = 0.091$ s.

6.1.2. *Other simulation results.* The obtained simulation results are plotted in Figures 9–12. Because of the normalized nature of the system variables, their artificial units are omitted.

[‡]Its the time necessary to resolve the optimization problem.

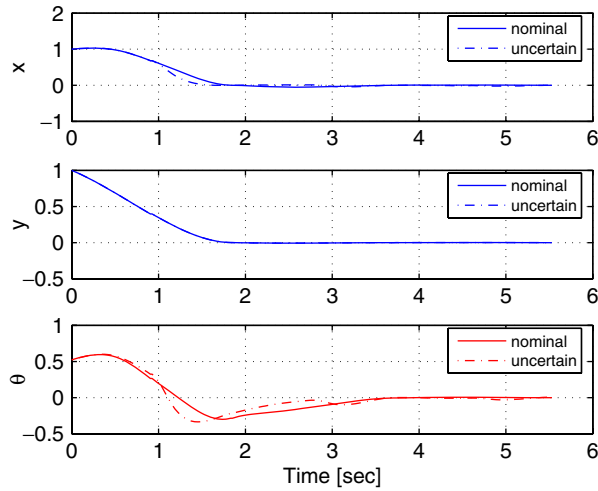

Figure 13. Evolution of the PVTOL position and orientation.

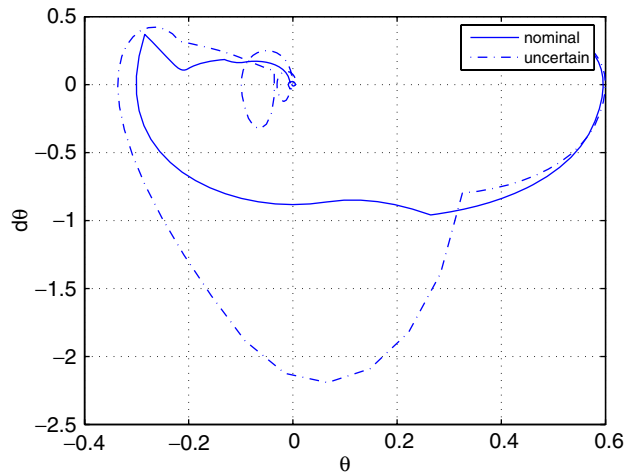

Figure 14. Phase portrait of internal dynamics.

In Figure 9, the evolution of the position and orientation of the aircraft are plotted *versus* time, where it could be seen that the aircraft is stabilized over 3.5s. The internal dynamics of the system is shown in Figure 10, which displays the phase portrait $(\theta, \dot{\theta})$. Figure 11 displays the movement of the aircraft in the vertical plane during the stabilization. The control actions generated by the proposed controller are shown in Figure 12. According to this figure, it could be clearly seen that the constraints on the control inputs are satisfied, namely the thrust is directed upwards the aircraft (i.e. $u_1 > 0$) throughout the stabilization operation.

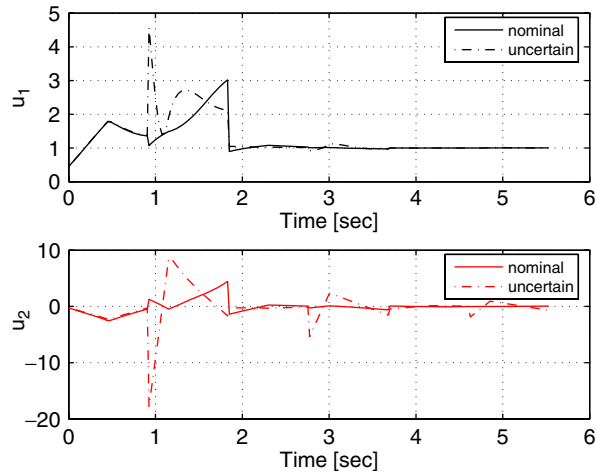

Figure 15. Evolution of the control inputs.

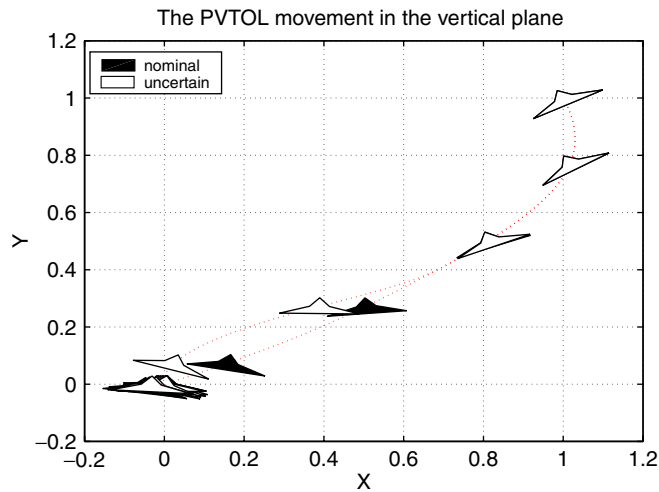

Figure 16. Stick figures of the PVTOL in the vertical plane.

6.2. Robustness towards parameters uncertainties

To attest the efficiency of the proposed control approach, let us consider uncertainties on the system model parameters, and especially on the coupling parameter ε , since it is often unknown and could not be measured:

$$\varepsilon_u = \varepsilon + \Delta_\varepsilon$$

Let the uncertainty Δ_ε be 10% of the nominal value. The system will be simulated with the same parameters of control approach as the above simulation. The obtained results are illustrated

through the simulation curves of the nominal system plotted together with those of the uncertain system. This will enable us to see the effect of the introduced uncertainty. Figure 13 displays the evolution of the aircraft coordinates (x, y, θ) versus time. It is worth noting that the uncertain system is also stabilized over 3.5s. The phase portrait of the system's internal dynamics is depicted in Figure 14, where the evolution of the velocity of the roll angle is plotted versus its position. The generated control inputs are shown in Figure 15. Figure 16 displays snapshots of the PVTOL aircraft position and orientation. Therefore despite the uncertainty considered the controller manage to stabilize the system. This fact shows the robustness of the proposed controller against parameters uncertainties.

7. CONCLUSION

Planar vertical take-off and landing (PVTOL) aircraft is an interesting illustration example of nonlinear under-actuated non-minimum phase systems that gain increasing interest within the control community. In this paper, a nonlinear prediction-based control approach is proposed to resolve the stabilization problem. The proposed control approach is based on partial feedback linearization, and optimal trajectories generation to enhance the behaviour and the stability of the system's internal dynamics. The stability analysis of the resulting closed-loop system is performed using a graphical tool based on Poincaré's section. The approach performance and robustness are illustrated through simulation case studies.

REFERENCES

1. Hauser J, Sastry S, Kokotovic P. Nonlinear control via approximated input-output linearization: the ball and beam example. *IEEE Transactions on Automatic Control* 1992; **37**:392–398.
2. Martin P, Devasia S, Paden B. A different look at output tracking: control of a vtol aircraft. *Automatica* 1996; **32**(1):101–107.
3. Di Giamberardino P, Djemai M. Multirate digital control of a PVTOL. *Proceedings of the IEEE Conference on Decision and Control*, Florida, U.S.A., 1994; 3844–3849.
4. Fantoni I, Zavala A, Lozano R. Global stabilization of a PVTOL aircraft with bounded thrust. *Proceedings of the IEEE Conference on Decision and Control*, Nevada, U.S.A., 2002; 4462–4467.
5. Teel AR, Murray RM, Walsh GC. Non-holonomic control systems: from steering to stabilization with sinusoids. *International Journal of Control* 1995; **62**(4):849–870.
6. Zavala A, Fantoni I, Lozano R. Global stabilization of a PVTOL aircraft with bounded inputs. *International Journal of Control* 2003; **76**(18):1833–1844.
7. Lin F, Zhang W, Brandt RD. Robust hovering control of a PVTOL aircraft. *IEEE Transactions on Control Systems Technology* 1999; **7**(3):343–351.
8. Chemori A, Alamir M. Limit cycle generation for a class of nonlinear systems with jumps using a low dimensional predictive control. *International Journal of Control* 2005; **78**(15):1206–1217.
9. Hauser J, Sastry S, Meyer G. Nonlinear control design for slightly non-minimum phase systems: application to v/stol aircraft. *Automatica* 1992; **28**(4):665–679.
10. Olfati-Saber R. Global configuration stabilization for the vtol aircraft with strong input coupling. *Proceedings of the IEEE Conference on Decision and Control*, Sydney, Australia, 2000.
11. Khalil HK. *Nonlinear Systems*. Prentice-Hall: London, 1996.
12. Isidori A. *Nonlinear Control Theory*. Springer: Berlin, Heidelberg, 1995.
13. Camacho EF, Bordons C. *Model Predictive Control*. Springer: Berlin, 1999.
14. Lohmiller W, Slotine J-JE. On contraction analysis for nonlinear systems. *Automatica* 1998; **34**(6):683–696.
15. Lohmiller W, Slotine J-JE. Nonlinear process control using contraction theory. *AIChE Journal* 2000; **46**(3):588–596.