



HAL
open science

Determination and evaluation of the possible links and sequences between TRIZ and other design methods.

Julien Durand, Pierre-Alain Weite, Claude Gazo, Philippe Lutz

► To cite this version:

Julien Durand, Pierre-Alain Weite, Claude Gazo, Philippe Lutz. Determination and evaluation of the possible links and sequences between TRIZ and other design methods.. ICED'07, Aug 2007, Paris, France. CD ROM - 11 p. hal-00174135

HAL Id: hal-00174135

<https://hal.science/hal-00174135>

Submitted on 21 Sep 2007

HAL is a multi-disciplinary open access archive for the deposit and dissemination of scientific research documents, whether they are published or not. The documents may come from teaching and research institutions in France or abroad, or from public or private research centers.

L'archive ouverte pluridisciplinaire **HAL**, est destinée au dépôt et à la diffusion de documents scientifiques de niveau recherche, publiés ou non, émanant des établissements d'enseignement et de recherche français ou étrangers, des laboratoires publics ou privés.

DETERMINATION AND EVALUATION OF THE POSSIBLE LINKS AND SEQUENCES BETWEEN TRIZ AND OTHER DESIGN METHODS

Julien Durand¹, Pierre-Alain Weite², Claude Gazo³ and Philippe Lutz⁴

¹Institut de productique, ²Laboratoire M3M UT Belfort Montbéliard,

³ADEFI, ⁴LAB UMR CNRS 6596 ENSMM UFC

ABSTRACT

TRIZ was really developed in the occident during the 90th and at the end of the 90th for Europe. Probably, the industrial development is not at the level of its potential. It sometimes uses some notions or data very close to the ones used in other methods like functional analysis or FMECA, nowadays widely implemented in the companies product development processes, and constitutes a useful complement of that methods, through its problem resolution process. Identifying and characterizing the possible links between the current methods and TRIZ could thus be an interesting way to improve the design process efficiency.

Our research approach has consisted firstly in a decomposition of each method in elementary bricks. Then we analyzed these elementary bricks and according to their objectives and input and output data, we defined possible links enabling to move from a method to TRIZ and conversely. In order to remain close to industrial realities, that work also includes several case studies very useful to detect the links as well as validate them; some of the links we identified are illustrated into a technical example.

That approach makes it possible to structure design process, not by a sequence of methods, but by possible sequences of elementary steps (the "bricks") coming from one or another method in order to exploit their contributions as well as possible, and according to each project specificities.

Keywords: Design Process, Design Methods, TRIZ, TIPS, Functional Analysis, QFD, FMECA

1 INTRODUCTION

Designers of technical products have some methods able to help them; some of those methods (like QFD, Functional Analysis, Value Analysis, and FMECA) have become very usual in industrial projects as far as some companies included them in their standards defining their product development process.

TRIZ method [1] appeared in Europe only in the late 90's, and some of its approaches differ from more classical ones. Indeed, it proposes a whole of concepts and methodological tools intended to help designers to set and solve technical problems.

Compared to the other methods, TRIZ main originality is to propose solution models linked to problem models, thus helping designers to build their structural answer from a functional need [2].

Thus it appears that TRIZ is a very useful complement for the other methods: for instance, it could be interesting to model and solve with TRIZ the contradictions between performances criteria identified during a Functional Analysis.

Otherwise, some of the notions used by TRIZ, for instance "function", are sometimes close to the ones used by other methods.

It becomes then interesting to determine what parts of TRIZ could be linked to other methods or steps of methods.

Some works were already undertaken to define the possible relations between TRIZ and the other design methods. For example, several authors [3] [4] noticed that the roof of the House of Quality in QFD allows finding technical contradictions which can be solved with the TRIZ Matrix. Others identified some links between Value Analysis and TRIZ [5] on a macroscopic scale suggesting for instance to use TRIZ during phases 3 and 4 of Value Analysis (analysis of functions and costs and search of ideas and ways of solution), or between the tools of the Internal Functional Analysis and

TRIZ [6] [7] in a more local approach: TRIZ is useful to check the exhaustiveness of flows in Internal Functional Analysis.

It's thus necessary to look very closely at the possible links which can exist between TRIZ and the other design methods, on an observation scale making it possible to determine if data produced by a method can feed another one.

We chose to proceed in five steps:

- Bibliography
- To split each method studied in a relatively fine way in order to identify their elementary “bricks”,
- To characterize each of these bricks by their input and output data,
- To build a cartography of the possible links between tools,
- To test and validate this links on industrial cases.

Our approach, operated systematically and in relatively fine way, aims to analyze, by a decomposition in elementary bricks of TRIZ, External and Internal Functional Analysis, FMECA, and Q.F.D., the various places where it's possible to use TRIZ tools from an another method and conversely; this research work having for finality to define and characterize methodological links.

2 METHODS SPLITTING UP

In this search for inter-methods links, the first stage was to define the level of description of links. Considering links on a macroscopic level (i.e. looking for links from a whole method to another) is only of little interest for designers, since every whole method is too long and too heavy to make it possible to stack up two or more of them.

So the first phase of the study was to split up each method, into elementary "bricks". Thus before the search for links, we subdivided these methods into stages and elementary tools as far as possible.

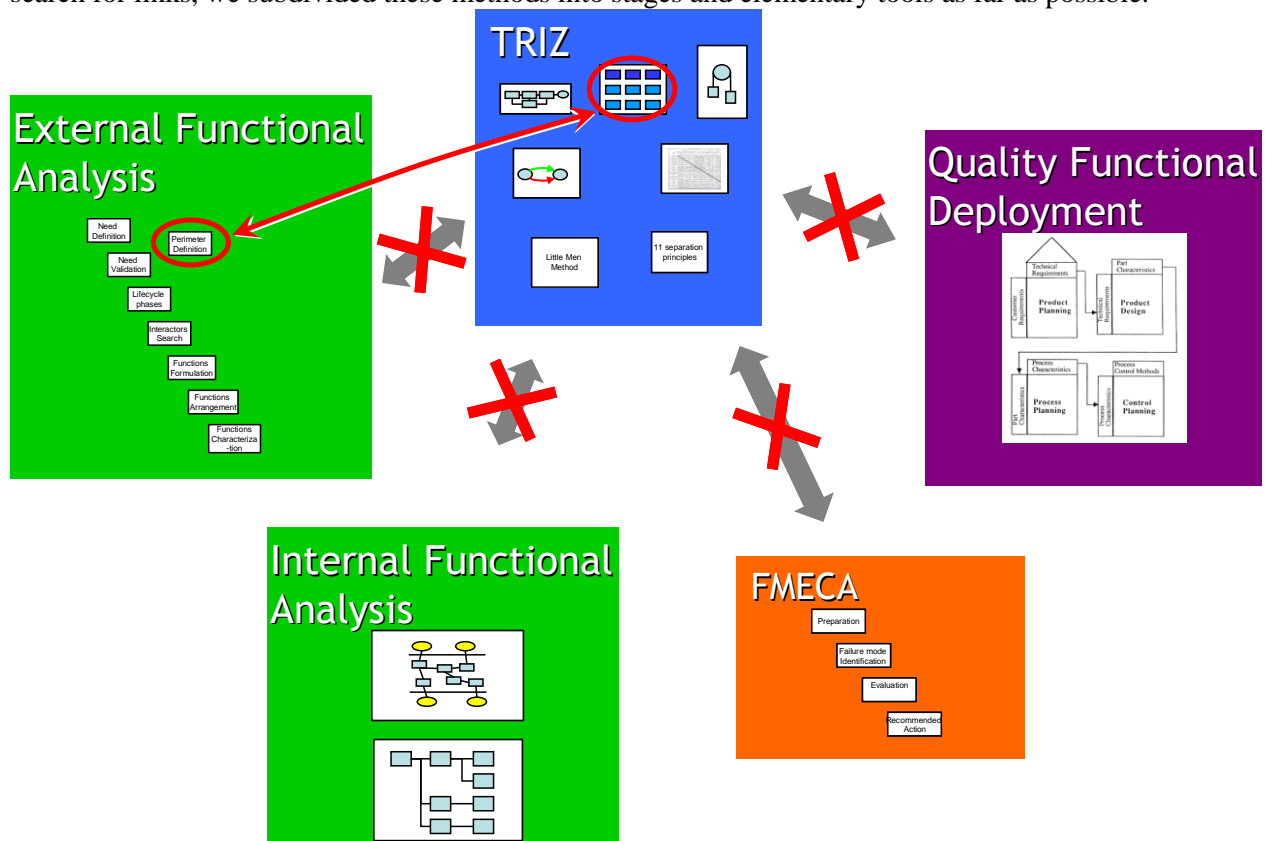

Figure 1. Consider links between TRIZ and other design methods on a macroscopic level would lead only to descriptions of macroscopic and not exploitable links

Reaching this level of description enables to define clearly each step and concept, and sometimes to formulate definitions, where the "Letter of the Law" is more or less vague. Another interest is to identify clearly the objectives and the data processing in each brick in order to characterize the input and output data.

For instance for External Functional Analysis, these elementary bricks are: definition of system boundaries, need definition, need validation, interactors search, functions formulation....

As for TRIZ, we split up this method into tools and elementary concepts such as: primary useful function, multi-screens diagram, law of system completeness, technical contradiction...

Once elementary bricks are defined, it becomes possible to describe precisely their input and output data.

It's worth noting here that various types of data can be met. It's by analysis of these data kinds that a serious comparison between design methods can be considered.

3 ELEMENTARY BRICKS CHARACTERIZATION

The step immediately following the splitting up one consists in describing any elementary bricks by answering to the following questions:

What are the pre-requisites (demanded data for starting) to use this tool?

What are the data handled by this tool?

What are the relations established between these data?

What is the aim of this tool? Its added value?

What is the utility of this tool in the process?

Example: Multi-screens Diagram

Multi-screens diagram is a tool of data extraction and representation. It constitutes a framework of representation locating the system on temporal and systemic axes (subsystems, system, super system or similar sets of systems) [8] [9]. It helps to validate the system boundaries and to detect its main probable future evolutions, allowing defining the Ideal End Result without being influenced by "psychological inertia".

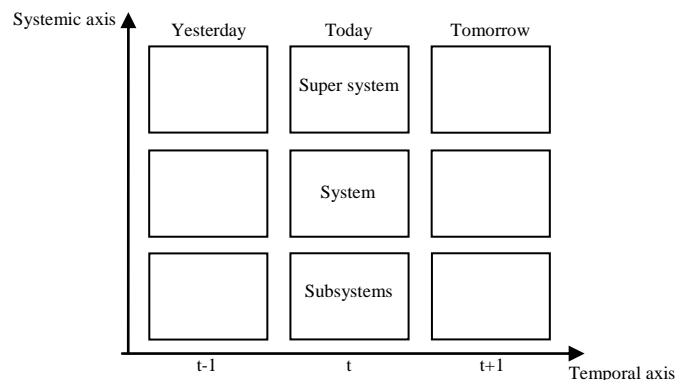

Figure 2. Multi-screens diagram

Data Analysis

What are the pre-requisites (demanded data for starting) to use this tool?

A system with technical evolutions.

What are the data handled by this tool?

Data handled by this tool are:

- Functional and Structural descriptions of objects in each screen.
- Parameters identified as significant in the evolution of these objects.

What are the relations established between these data?

- Qualitative and quantitative remarkable evolutions which define technical jumps between t-1(yesterday) and t (today). The evolutions are detected by analyzing the parameters modifications.
- Extrapolation of these evolutions between t (today) and t+1 (tomorrow). Key properties (specifications) of the future system are deduced from tomorrow super system definition

(evolution of the I.E.R.). Tomorrow subsystems constitute some means to answer to these specifications.

What is the aim of this tool? Its added value?

- To emphasize the tendencies of evolution
- To identify the systemic levels

What is the utility of this tool in the process?

The goal of multi-screens diagram is:

- To provide a description of the product (to trace the perimeter of the system),
- To build a description of what the system is now and what ideally it should be made tomorrow and to make all the workgroup members share this common vision.
- To identify contradictions as conflicts between tomorrow super system requirements and today or tomorrow subsystems.
- To place the I.E.R. in relation to the various systemic levels. The multi-screens diagram enables to correctly define the systemic level, in agreement with the Ideal End Result, and to answer the question: "On what level do we want to work? On the system, on the super system or on the subsystems?"

Thus, in this example, it is possible to represent input and output data as follows:



Figure 3. Input and output data of the multi-screens diagram

Input data:

- A technical system with a history
 - o Structural and Functional Description of actual system
 - o System history
 - Parameters characterizing the previous technical jump

Output data:

- System boundaries
- New vision of the system: evolutions
 - o Probable evolution imposed by the future super system
 - o Future resources brought by the future subsystems
- Contradictions
 - o Conflicts between requirements

The analysis of each stage, tool or concept, as illustrated in the case of multi-screens diagram, enables to constitute a table of data, indexing them with an equivalent degree of description; this equivalence of description thus making them comparable.

Table 1. Table of data analysis

Method	Step / Tool / Concept	Succeed to...	Input Data	Input Data Typology	Tool Internal Operations	Output Data	Output Data Typology	Antecedent to ...

Following constitution of this table, it seems clearly that typologies of input and output data are in a limited number. We will quote for instance that the concept of function is present in several design methods. In the same way, components and interactors such as defined in Functional Analysis or in FMECA come close to the concept of substance as defined in TRIZ. Another connection based on kinds of data concerns engineering requirements of QFD, function specifications of Functional Analysis, and parameters intervening in technical contradictions.

4 CARTOGRAPHY

Once objectives and input and output data characterized for each elementary brick, we can now consider the complementarities between steps and tools arising from various methods.

According to this level of description, it becomes possible to identify the redundancies and specific originalities of each elementary brick, and also to bring to light the inter-methodological linking possibilities. We called "links" each inter-methodological linking possibility exploiting the opportunity of using output data of a tool as input data in another.

It results from this systematic approach that application of links between design methods and TRIZ brings real methodological complements. Indeed TRIZ helps designers to formulate technical solutions in agreement with functional specifications previously defined. TRIZ also helps designers to identify the structural compromise existing into the system.

We mention here some of the links that we have formulated.

Firstly, between External Functional Analysis and TRIZ: we identified that the step of Need Validation of Functional Analysis [10], in which the work group considers the potential evolutions of need causes and goals, can be helped by several descriptive and predictive tools of TRIZ, like multi-screen and evolution laws, which bring some structured representations and enable to formulate several hypothesis on the future evolutions of the system.

Another link example consists in an analysis and a crossing of function specifications, in order to identify the compromises existing in the system. These compromises may be then formulated as technical or physical contradictions, which are models of problems specific to TRIZ.

Internal Functional Analysis is also a good starting point to application of tools of TRIZ [11]. Indeed, during constitution of Functional Flows Diagram, a technical solution is studied in order to identify the roles of each component, by the identification of functional flows into the system [12]. Interactions between two components, underlined by this type of diagram, can be formulated as TRIZ Su-Field diagram. Please take note here that it's not a simple "translation", since TRIZ concept of field and Functional Analysis concept of function are close but not strictly equivalent: an important difference being that field can translate a harmful effect, whereas function formulates only a desired action.

Concerning Q.F.D., several works were already undertaken to connect it to TRIZ. Thus several authors [3] [4] already propose to switch towards tools of TRIZ starting from conflicts between engineering requirements [13] thus enabling to identify and to elude compromises.

Failure modes identified during a FMECA correspond to "structural answers" whose actions inter or intra-components do not respect anymore the setting signal, and thus generate not-desired effects. Su-Field diagram enables to represent this type of dysfunction by a field described as harmful, excessive or insufficient between two substances. To these models of problem are associated models of resolution, called standards (for solving inventive problems). Thus let us underline, in this case, that TRIZ brings some help to solve problems, where FMECA identifies and indicates that it's necessary to set up plans of action in order to reduce the Risk Priority Number, without giving any indication on the way to go to do it.

In their final form, the links constitutes inter-methodological switch opportunities which could take the shape of computerized inter-methodological switch procedures. These procedures describe propositions of good utilization practices. Thus all the links we identified have been translated into UML (Unified Modeling Language). This language allows to represent the various objects concerned by links in a static approach and also to represent the data flows in a dynamic approach.

5 EXPERIMENT

In order to remain close to industrial realities and to validate the links, the search of inter-methodological links between TRIZ and the other design methods hasn't been only theoretical. Indeed we also worked on case studies, applied within several companies of Franche Comté. Thus, these companies agreed to use their new product development projects as experimental field for this research work, able to help them to structure their design activity.

Through study cases, we proceeded in several steps.

First studies aim was to detect in an empirical way the possible links in order to confirm and complete the decomposition and characterization steps of our approach.

The following ones have been conducted in a more structured way, in order to validate the complementarities and linking revealed by the theoretical approach.

Example of application of inter-methodological links: a vise

As an example, the links between some Functional Analysis steps and several tools of TRIZ will now be applied to a relatively simple technical system: a multi-directional mechanical vise. This system enables to fasten a object to a fixed support.

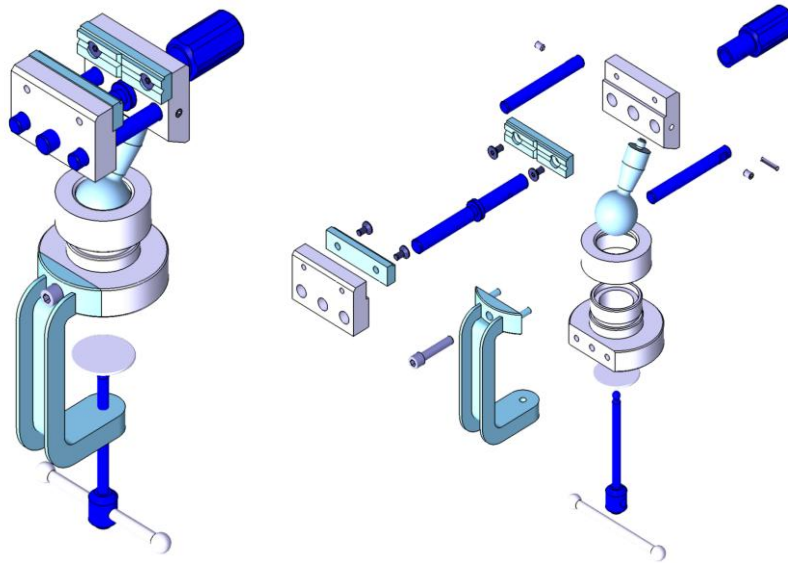

Figure 4. Vise assembled & disassembled

Link between F.A. Need Definition and TRIZ Multi-screens

Need definition and its validation are essential steps of External Functional Analysis. It's a step consisting in an identification of the need – the main reason for which the system has been created - and a reflexion on its possible evolutions [10]. This is obtained by a questioning on goals and causes of the need and on their probable evolutions.

Need Definition:

- WHO will be help by this product?
Operator
- WHAT will this product act on?
Object / Part / Mechanical Component
- WHAT is the product goal?
To fasten an object in position

Need Validation:

- What does the goal exist for? (the goals of the goal)
 - To work on part or on mechanical component
 - To carry out some operations on an object
- Why does this goal exist? (the goal causes)
 - Considering the operations that the operator has to do, he cannot hold the object.
 - Considering the operations that the operator has to do, a high stability is required.
- Need Evolution Conditions and Need cancellation conditions
 - That the tool which operates on the object has a hold device.

As previously described, multi-screens diagram is a tool of data extraction and representation. It constitutes a representation framework enabling to locate a system on temporal and systemic axes.

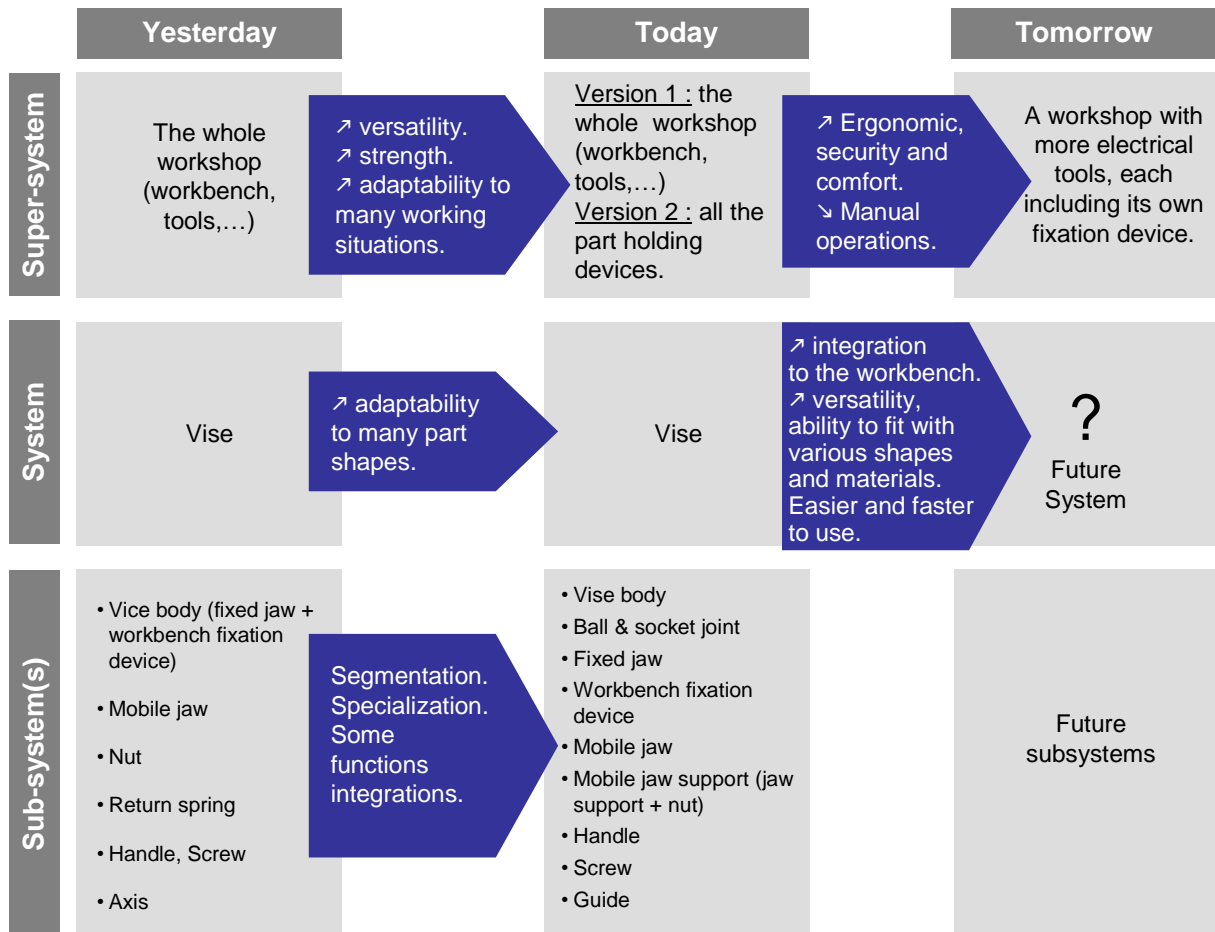

Figure 5. Multi-screens diagram

Some of the data handled in that two tools are close as are their interrogations. Whereas the questioning on the need validation operates as a way to check the durability and the evolution of the need, the multi-screens diagram gives (among other things) axes of reading with regard to temporal evolution ("structural answer" to the need and its evolution) on upper (super system) and lower (subsystems) systemic levels [8] [9].

That is why, in complement of classical approach of External Functional Analysis, multi-screens diagram can be applied.

As the figure 5 shows it, the multi-screens diagram, coupled to the need validation, makes it easier firstly to define the system perimeter and to identify some interactors, and secondly "to predict", through a study of the system expectable evolutions, what should be the future system; and it thus gives some guidelines concerning the functional specifications.

It should be noted that for these two steps, both uses common data. Indeed, the "goals of the goal" corresponds to one of the main functions of the super system. The super system defined, in the multi-screens diagram, enables to anticipate the interactor's identification.

The relevance of the use of multi-screens diagram is to provide a formalized tool enabling the study group to consider the possible evolutions of the system. Multi-screens diagram may be used here in a phase where "the Letter of the Law" of External Functional Analysis only offers a poor help to designers: indeed it only stipulates "define the perimeter of the technical system" without giving us tools to do it.

Thus, we propose this sequence: Firstly, validate the need, then, use multi-screens diagram enabling to work on future evolutions of the system, and finally return to the External Functional Analysis with more precise definitions of the system evolution tendencies.

Link between F.A. Function Formulation and TRIZ Law of system completeness

Another interesting links consists in using law of system completeness during the search and characterization of system functions. This step of Functional Analysis consists in listing the interactors which the system will have to coexist with and identifying functions that it will have to fulfil. During this step, we generally employ a diagram in which the system is surrounded with its interactors, functions being represented like relations between these various elements.

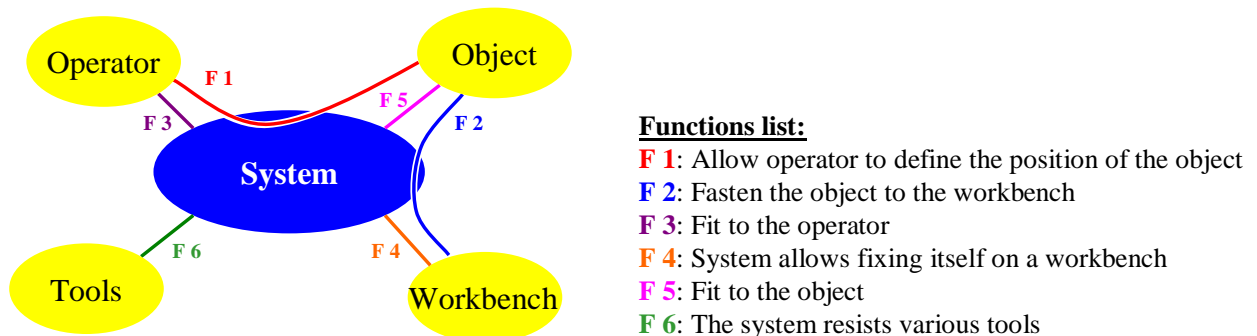

Figure 6. Function formulation step

The law of system completeness decomposes the system into four parts: a Working Unit, an Engine, a Transmission and a Control Unit; the working unit is connected to the object modified by the system action, whereas the engine is connected to the energy source. This law describes structurally any technical system. Associated to laws of "conductibility of energy" and coordination (harmonization of rhythms), it enables to underline its weaknesses.

Applying the law of system completeness, in parallel of the search of the functions, is a way to check the major interactors in contact with the technical system.

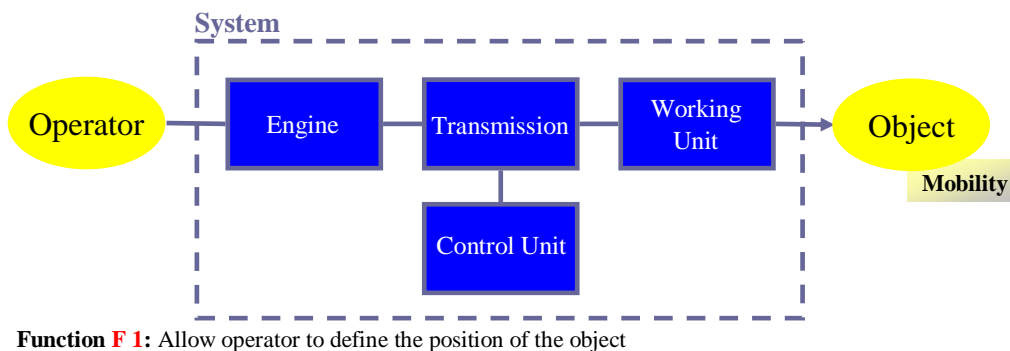

Figure 7. Law of System Completeness

As the law of system completeness underlines it, each action of the technical system on an interactor implies a connection to a source of energy. Thus this law enables to think as soon as possible about energy resources usable by the technical system.

Let us underline here that there's only a relation of proximity and not of equality between these various elements. Since TRIZ often focuses on particular technical problems, it often leads to a more accurate scale description than a classical Functional Analysis approach, which aims to build a global functional representation of the system.

This link induces another link between the Functional Analysis and TRIZ; i.e. connection between Functional Flows Diagram and Law of system completeness.

Link between F.A. Functional Flows Diagram and TRIZ Law of system completeness

Functional Flows Diagram is a diagram based on functional flows study. It represents system components, connected at first by contact elementary functions, then by flows representing paths of energy, substance or data. This diagram describes how the system fulfils its functions and also how each component participates to functions accomplishment.

Functional Flows Diagram enables to have a both functional and structural representation of the system. It connects components and interactors and brings to light the functions and their paths into the system.

Thus Functional Flows Diagram and Law of system completeness have close aims: describe the technical system and inform on roles of each component.

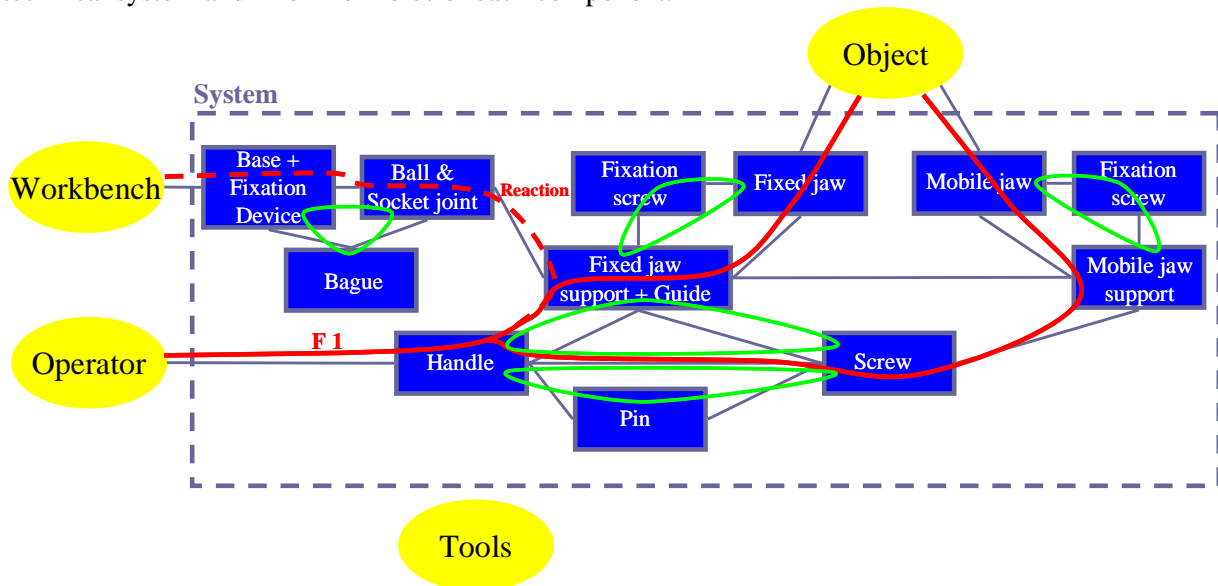

Interaction Functions:

- F 1:** Allow operator to define the position of the object
- F 2:** Fasten the object to the workbench

Adaptation Functions:

- F 3:** Fit to the operator
- F 4:** System allows fixing itself on a workbench
- F 5:** Fit to the object
- F 6:** The system resists various tools

Figure 8. Function Flows Diagram

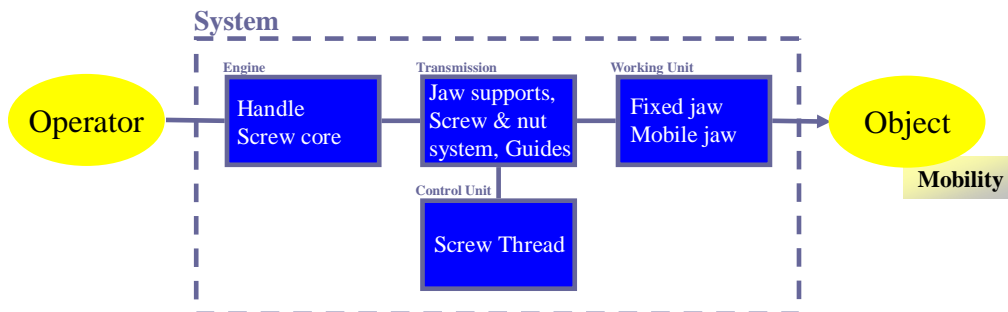

Function F 1: Allow operator to define the position of the object

Figure 9. Law of system completeness

These two diagrams enable to identify functions path through the system. In this link TRIZ helps to identify role of each component and enables to better understand how does work the system by the separation of energetic and information paths.

Thus, this representation enables to interrogate the good realization of the function by regarding its structural answer as being made up of four elementary functional parts.

Moreover, the paths representing a given function have to involve the same components or sets of components in both diagrams.

On the other hand, let's underline again that if parallels can be established between these diagrams, we cannot conclude on the concepts equality that they handle, particularly because of differences of description level on both sides. Indeed, Functional Flows Diagram often considers globally a component, without needing to split it into smaller parts, whereas TRIZ often leads to a more accurate scale of description, for instance by considering specially an interface instead of the whole part itself.

6 CONCLUSION

This study aims to build cartography of links between TRIZ and other design methods well known and used in industry.

The splitting up of each method into elementary bricks allows to determine precisely the kind of input and output data, and to detect and describe possible links between methods.

One purpose of that work is also to allow a better use and assimilation of TRIZ by companies. Indeed, TRIZ appears like the "missing chain link" between product specification and structural answer, making it very complementary to other methods.

Moreover, it becomes possible to structure design process, not by a sequence of methods, but by possible sequences of elementary steps (the "bricks") coming from one or another method in order to exploit their contributions and specificities as well as possible. For instance, we thus observed that it's relevant, during a Functional Analysis, to make a turning by some tools of TRIZ likely to help to decide on the system perimeter.

The design process can thus be built according to reasons which can be related to the treated project (ex-nihilo design, resolution of a technical problem), but which can also be of an organisational nature (for instance: to use as main thread a method well-known of the company or appearing in its procedures).

The question of the links between design methods takes a particular weight for a software development: a possible strategy consists in developing independent modules for each "brick" ("micro-tool" concept, [14]), another one aims to instrument each method before trying to link them. In all cases, it is particularly important to locate data of similar natures used in different steps of the design process (in order to statute on their possible equality, and reach the data uniqueness), but also to detect the "false friends" (given similar but no equal natures).

At last, that links can be seen as vectors able to increase the use of TRIZ on industrial projects; indeed, TRIZ is still very few used in spite of its potential. Through detecting in the current – and well known and acknowledged – methods some possible germs of TRIZ approaches, the links can help to convince the designers to try a method that they still often see as complex and difficult to use.

REFERENCES

- [1] Altshuller G. S. *And suddenly the inventor appeared*, Technical innovation Center, Inc. 1984 (Worcester, Massachusetts).
- [2] Durand J., Weite P.-A., Gazo C., and Lutz P. Propositions de passerelles inter-méthodologiques entre la démarche d'invention TRIZ et les autres méthodes de conception, In *Congrès International de Génie Industriel, CIGI '07*, Trois-Rivières, June 07.
- [3] Verduyn D., Wu A. Integration of QFD, TRIZ and Robust Design (overview & "Luggage" Case Study), *American Supplier Institute*, 1996.
- [4] Terninko J. The QFD, TRIZ and Taguchi Connection: Customer-Driven Robust Innovation. In *The ninth Symposium on Quality Function Deployment*, 1997.
- [5] Cavallucci D. *Contribution à la conception de nouveaux systèmes mécaniques par intégration méthodologiques*, 1999, pp.65-74, Rapport de thèse, Université Louis Pasteur, Strasbourg.
- [6] Doré R. *Intégration des sensations utilisateur en conception préliminaire*, 2004, Rapport de Thèse, Ecole National Supérieur des Arts et Métiers, Bordeaux.
- [7] Vernat Y. *Formalisation et qualification de modèles par contrainte en conception préliminaire*, 2004, Rapport de Thèse, Ecole National Supérieur des Arts et Métiers, Bordeaux.
- [8] Altshuller G.S. *Creativity as an exact science*, 1988 (Gordon and Breach, New York).
- [9] Seredinski A. *System Operator and the Methodology of Prediction*, 2002, TRIZ Journal.
- [10] Tassinari R. *Le Besoin. Pratique de l'analyse fonctionnelle*, 2003, pp.29-38 (Ed. DUNOD)
- [11] Scaravetti D. *Formulation préalable d'un problème de conception, pour l'aide à la décision en conception préliminaire*, 2004, Rapport de Thèse, Ecole National Supérieur des Arts et Métiers, Bordeaux.
- [12] de la Bretesche B. *La méthode APTE, Analyse de la valeur, analyse fonctionnelle*, 2000 (Ed. Petrelle, Paris).
- [13] Ullman D. G. Understanding the problem and the development of engineering specifications. *The Mechanical Design Process 2nd ed.*, 1997 (McGraw-Hill College)
- [14] Weite P.-A., Fougères A.-J., and Gazo C. Les Micro-outils, vecteurs d'appropriation de conception et d'innovation. In *Congrès International de Génie Industriel, CIGI '05*, Besançon,

June 05.

Contact: Julien Durand
institution/university: Institut de Productique
street: 24 rue Alain Savary
PO Box, City: 25000 Besançon
Country: FRANCE
Phone: +33 3 81 40 20 07
Fax: +33 3 81 40 57 01
e-mail: julien.durand@productique.com