



HAL
open science

A formalism for machine translation in MTT, including syntactic restructurings

Sylvain Kahane

► **To cite this version:**

Sylvain Kahane. A formalism for machine translation in MTT, including syntactic restructurings. Third International Conference on Meaning Text Theory (MTT), May 2007, Klagenfurt, Austria. hal-00170539

HAL Id: hal-00170539

<https://hal.science/hal-00170539>

Submitted on 20 Sep 2019

HAL is a multi-disciplinary open access archive for the deposit and dissemination of scientific research documents, whether they are published or not. The documents may come from teaching and research institutions in France or abroad, or from public or private research centers.

L'archive ouverte pluridisciplinaire **HAL**, est destinée au dépôt et à la diffusion de documents scientifiques de niveau recherche, publiés ou non, émanant des établissements d'enseignement et de recherche français ou étrangers, des laboratoires publics ou privés.

A formalism for machine translation in MTT, including syntactic restructurings

Sylvain Kahane

Modyco, Université Paris 10 - Nanterre & CNRS
sk@ccr.jussieu.fr
<http://www.kahane.fr>

Abstract

This paper presents a new formalisation of the transfer-based translation model of the Meaning-Text Theory. Our modelling is based on polarized correspondence grammars and observes a strict separation between the monolingual models, a minimal bilingual lexicon and universal restructuring rules, directly associated with syntactic lexical functions.

Keywords

Machine translation, paraphrase, syntactic restructuring, MTT (Meaning-Text Theory), dependency grammar, lexical function, bilingual lexicon, PUG (Polarized Unification Grammar), correspondence grammar, synchronous grammars.

1 Introduction

The aim of this paper is the modeling of the syntactic restructurings in a transfer-based translation system. The architecture we consider was introduced at the beginning of works in machine translation [MT] (Kulagina & Mel'čuk 1967) and picked up by various systems and in particular the Etap-2 platform (Apresian *et al.* 2003), the TransLex system (Nasr *et al.* 1997, Lavoie *et al.* 2000) and the Eurotra project (Arnold & des Tombes 1987, Danlos & Samvelian 1992). This architecture is characterized by a minimization of the bilingual lexicon; the rules which allow the restructurings are universal and separated from the monolingual grammars.

Our contribution is only at a theoretical and formal level. The examples we study are very well known (Tesnière 1959 (chapters on metataxis), Lindop & Tsujii 1993, Dorr 1994) and our work is not implemented. We nevertheless think that even if most of these phenomena are considered in many studies, it is still possible to improve the modeling of the translations using such syntactic restructurings. If various transfer-based systems have been developed, few works propose a clean formalism for writing a transfer module. Most of the systems use ad hoc procedural transfer grammars based on tree rewriting and tree transformations. The

most achieved formalizations I know use synchronous grammars (Abeillé *et al.* 1990, Nesson *et al.* 2006 or Ding & Palmer 2005), but such architectures do not enforce a strong separation between bilingual lexicon and monolingual grammars, since the rules of monolingual grammars themselves are aligned.

Our modeling lies within the scope of the Meaning-Text Theory [henceforth MTT] (Žolkovskij & Mel'čuk 1967, Mel'čuk 1988a), a linguistic theory which was initially developed from the point of view of MT. The modeling of restructuring in MTT was treated in detail in Mel'čuk 1988b and more recently in Mel'čuk & Wanner 2006. We will show that the formalization we propose, using the polarized correspondence grammars developed in Kahane 2006 and Kahane & Lareau 2005, is at the same time simpler and more rigorous. In particular we explore more in depth the algebra of restructuring rules.

We will start by introducing, in Section 2, the central concept of “significant unit”, a new definition of the DSyntS, and the principle of translation by commutation of significant units. Section 3 presents syntactic restructurings and the bilingual lexicon we need in consequence. The restructuring rules and the polarized correspondence grammar, which brings them into play, are introduced in Section 4. Section 5 is devoted to the problem of multiple restructurings and the algebra of syntactic lexical functions. We finish with the classical problem of motion verbs in Section 6.

2 Translation, significant units and deep syntactic structure

Translating is expressing about the same meaning in another language. In the near total of the cases, it is possible to obtain a suitable translation by replacing each significant unit of the utterance in the source language by a significant unit of the target language expressing a similar meaning (and a priori seldom identical, which explains the difficulty of finding a satisfactory interlingua, even for a single language pair). In fact, the only cases where this is not possible are the cases where one of the significant units of the source utterance cannot be translated in a satisfactory way, cases which escape for the moment from any attempt to automatically translate.

Significant units [SU] (Martinet 1960: chap. 4; Ducrot 1995) are the indecomposable linguistic signs in their meaning: they are divided into lexical units (including phrasemes), grammatical units and constructions (within the meaning of construction grammars; Goldberg 1995). The SU are the units of choice; for example in the French utterance *La moutarde me monte au nez* (litt. The mustard goes me up to the nose, ‘I feel anger welling up in me’), there are 4 choices made by the speaker and as many significant units: the phraseme ‘LA MOUTARDE MONTER AU NEZ’, the pronoun MOI (in its clitic form *me*) which is the single actant of this phraseme, the present tense and the declarative construction (we will not consider this SU after, but it should be and is opposed for example to the interrogative construction).

Although the deep syntactic structure [DSyntS] is presented in many studies in MTT (Mel'čuk 1988a), this structure seems to me to have to be the subject of a better definition and some adjustments. For us, the DSyntS of an utterance is the structure that indicates how the SUs of an utterance combine. It can be seen as the derivation structure of the semantics-syntax interface (Kahane 2003). The surface syntax [SSynt] imposes a hierarchical structure to the DSyntS, which is a skeleton on which we indicate the numbers differentiating the various

actants. Surface syntactic relations, government and agreements do not appear in the DSyntS and can be recomputed from the lexicon and the grammar. The lexical units [LU] (that we note in small capitals followed by their part of speech [pos]) occupy the nodes of the DSynt tree. The grammatical units [GU] (or deep grammemes) are indicated as indexes of the LU they combine with. One of the difficulties for stating the DSyntS is that the SUs can combine in a different manner at the semantic level [Sem] and the SSynt level. However the DSyntS, which is precisely used as an interface between Sem and SSynt levels, must encode simultaneously both of them. Let us take the example of a raising verb such as SEEM in *Max seems to sleep*. At the Sem level, because of synonymy with *It seems that Max sleeps*, one can affirm that ‘seem’ has only one argument which is ‘sleep’, which has itself as argument ‘Max’. Moreover, at the SSynt level, MAX is the subject of the verb SEEM and not of SLEEP. In the DSyntS, we will thus state that SEEM has two actants, that we number 1 and 2, but that the 1st actant is “additional”, which we note with +, that is it appears only in SSynt. In addition, we indicate, by a superscript on the pos (V¹), that the 1st Sem actant of SLEEP is not realized as a SSynt dependent of SLEEP and, by a superscript 1 on the dependence between its governor and it (2¹), that it is realized as the 1st DSynt actant of its governor.

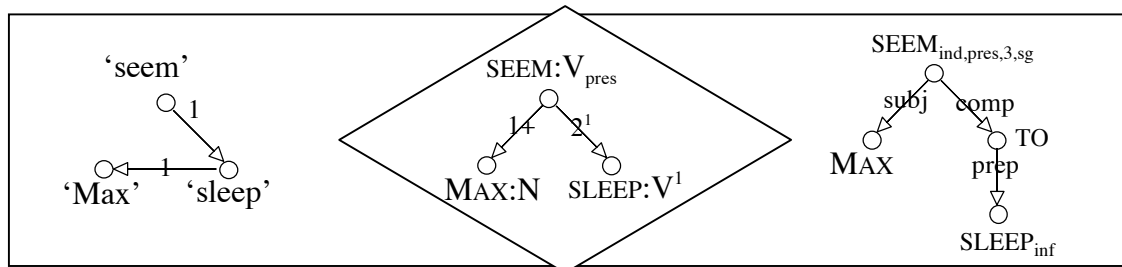

Fig. 1 The SemS, DSyntS et SSyntS of *Max seems to sleep*

Replacing in an utterance a SU by an equivalent SU (that is having about the same meaning), gives us a paraphrase. A translation will be obtained by simultaneously commutating all the SUs of a utterance of the source language by equivalent SUs of the target language.¹ When each SU of the source utterance is translated by an SU with an equivalent construction, the translation is particularly simple, both utterances having exactly the same DSyntS. We illustrate this by the following English-French translation:

$$(1) \quad \begin{array}{l} \mathbf{a.} \text{ He slept.} \\ \mathbf{b.} \text{ Il a dormi.} \end{array} \quad \begin{array}{c} \text{T} \left(\begin{array}{c} \text{SLEEP:V}_{\text{perf}} \\ \downarrow 1 \\ \text{HE:N}_{\text{sg}} \end{array} \right) \equiv \begin{array}{c} \text{T(SLEEP):V}_{\text{T(perf)}} \\ \downarrow 1 \\ \text{T(HE):N}_{\text{T(sg)}} \end{array} \equiv \begin{array}{c} \text{DORMIR:V}_{\text{passé-c}} \\ \downarrow 1 \\ \text{LUI:N}_{\text{sg}} \end{array} \end{array}$$

This translation is carried out in two stages. The first stage models our postulate: the translation of a utterance can be carried out by translating each SU separately. The second

¹ Collocations are the source of a well known problem (and elegantly solved in MTT). For example to translate *heavy smoker*, we need to know that HEAVY is a collocative of SMOKER, that is a LU whose choice is lexically constrained by another LU, its basis, here SMOKER. Although *heavy smoker* is the composition of two LUs, it is not possible to translate HEAVY separately in such a context. The English lexicon must indicate that $\text{Magn}(\text{SMOKER}) = \text{HEAVY}$, where Magn is the lexical function associating an intensifier to its basis, and translate HEAVY as a Magn value. For a translation into French, we thus translate SMOKER by FUMEUR and we consult the French lexicon to know $\text{Magn}(\text{FUMEUR}): \text{T}(\text{heavy smoker}) = \text{T}(\text{SMOKER} \oplus \text{Magn}) = \text{T}(\text{SMOKER}) \oplus \text{T}(\text{Magn}) = \text{FUMEUR} \oplus \text{Magn} = \text{gros fumeur}$.

stage commutates each SU with one of its possible translations by using the English-French bilingual lexicon:²

$\mathcal{L}_{E-F} =$ (SLEEP:V, DORMIR:V) (HE:N, LUI:N) (:V _{perf} :V _{passé-c}) (:N _{sg} :N _{sg})	$T_{E-F}(\text{SLEEP}) = \text{DORMIR}$ $T_{E-F}(\text{HE}) = \text{LUI}$ $T_{E-F}(\text{perf}) = \text{passé-c}$ $T_{F-E}(\text{sg}) = \text{sg}$
---	---

The bilingual lexicon (left-hand column) for these “simple” cases consists of a list of couples of significant units that are the translation of each other. In other words, saying that (SLEEP:V, DORMIR:V) is in the English-French dictionary comes down to saying $T_{E-F}(\text{SLEEP}) = \text{DORMIR}$ or that $T_{F-E}(\text{DORMIR}) = \text{SLEEP}$, where T_{E-F} and T_{F-E} are translation functions.³

3 Restructurings and bilingual lexicon

Let us consider the following classical examples:

- (2) **a.** *I miss you.*
 b. *Tu me manques.* (litt. You lack to me)
- (3) **a.** *Ich schwimme gern.* (litt. I swim willingly)
 b. *I like to swim.*
- (4) **a.** *Zoé needs a book.*
 b. *Zoé a besoin d'un livre* (litt. Zoé has need of a book)

For the translation (2), one must not only indicate that MISS and MANQUER are the translation of each other, but also that a conversion of the actants occurs. For (3), the German-English lexicon will have to indicate that GERN is an adverb whose verbal governor corresponds to the second actant of LIKE,⁴ while the subject of this verbal governor corresponds to the subject of LIKE. We can model that in two ways: either by indicating the diathesis in the bilingual lexicon (*à la Nasr et al.* 1997), or by expressing this diathesis change by a lexical function (*à la Mel'čuk & Wanner* 2006):

(MISS:V[1,2], MANQUER:V[2,1]) (GERN:Adv*[2[1]^], LIKE:V[1,2]) (NEED:V, BESOIN:N)	$T_{E-F}(\text{MISS}) = \text{Conv}_{12}(\text{MANQUER})$ $T_{D-F}(\text{GERN}) = \text{Adv}^1_2(\text{LIKE})$ $T_{E-F}(\text{NEED}) = \text{V}_0(\text{BESOIN})$
--	---

For the diathesis, we use the notations suggested by Kahane & Polguère 2001 for the explicit encoding of the lexical functions: $[x,y]$ denotes a list of actants by order of prominence (x is thus the first actant; for a verb it is the subject). For Adj or Adv, the first “actant” is in fact the syntactic governor, which we signal by the symbol \wedge (to read like an upward arrow).

² Of course, our bilingual rules are too simple and need additional information. For instance, the rule (HE:N, LUI:N) might indicate that HE is appropriate only if LUI refers to a +human entity (see Viegas 1997 for a quite simple formalization). The perfect-*passé composé* translation rule calls for far more complicated conditions.

³ T_{E-F} and T_{F-E} are not exactly functions, because the bilingual correspondence is many-to-many. Moreover, bilingual dictionaries are generally not considered as symmetrical. We think they must be; that a translation is more useful in one way than in the other way is due to monolingual information about the corresponding significant units.

⁴ More precisely, GERN is what we call an Adv*, that is an Adv which control the subject of its governor and then has two semantic actants.

Conv_{12} carries out the conversion of actants 1 and 2. Adv^1_2 adverbializes its key word: the subscript 2 indicates that this Adv will modify the 2nd actant of the key word, while the superscript 1 indicates that it controls also the 1st actant of its governor.⁵ V_0 is a verbalization without diathesis change. For (4), the bilingual lexicon indicates that the translation of the verb NEED is not a verb but the noun BESOIN and that is all; it is the lexicon of French who in addition states that this noun has the light verb $\text{Oper}_1(\text{BESOIN:N}) = \text{AVOIR:V}$.

4 Restructuring rules and syntactic lexical functions

A restructuring rule is associated with each syntactic lexical function (Mel'čuk 1988b). To write these rules we use the formalism of Polarized Unification Grammar [PUG] (Kahane 2006) and more precisely polarized correspondence grammars (Kahane & Lareau 2005). Three types of objects are considered:⁶ syntactic nodes represented by rounds, syntactic dependencies between nodes represented by arrows and correspondence links between nodes represented by dotted lines supplied with a diamond for the polarity. Each object receives a polarity in the form of a black or white color: the black objects are those which are handled by the rule, while the white objects express needs and must obligatorily be amalgamated with a black object. The correspondence is completed when, after merging, all the objects are black.

The rules associated with the lexical functions Conv_{12} and Adv^1_2 handle only dependencies:⁷ the syntactic nodes, as well as the links of correspondence between them, are thus white and must be built by other rules. The rule for Oper_1 introduces the additional node for the light verb Oper_1 and built a link (Fig. 2).⁸

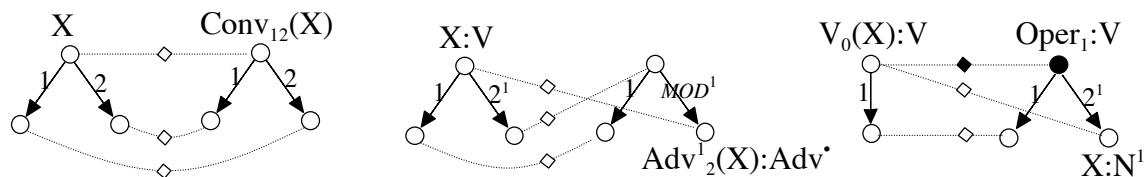

Fig. 2. Restructuring rules associated with Conv_{12} , Adv^1_2 and Oper_1

The correspondence between two DSyntSs is carried out by combining the restructuring rules and the copy rules ensuring the copy of the lexemes, grammatical units and dependencies which were not yet taken into account (Fig. 3).

⁵ Let us give another monolingual example: $\text{Adv}^1_2(\text{HURRY:V}) = \text{[IN A HURRY]:Adv}$ (*Max hurried out* \equiv *Max went out in a hurry*).

⁶ For sake of simplification, grammemes were not considered as objects, but they might be. Furthermore, the correspondence grammar does not try to ensure the well-formedness of DSyntSs that it makes them correspond. This can and must be ensured by an independent grammar. See Kahane & Lareau 2005 for the interfacing of a correspondence grammar and well-formedness grammars.

⁷ We note *MOD* the modificative relation (rather than *ATTR* as usual in MTT). Generally *mod* corresponds to a semantic dependency whose predicate is the dependent. The superscript 1 indicates that the 1st actant of the governor is also an argument of the dependent.

⁸ It is useful to link $V_0(X)$ both to X and to Oper_1 because a modifier can go as well on X (*Max a grand besoin d'un livre*, litt. Max has big need of a book) as on Oper_1 (*Max a vraiment besoin d'un livre*, litt. Max has really need of a book). The link with Oper_1 is built by this rule, while the other link must be validated by a lexical rule, such as $(\text{NEED:V}, \text{BESOIN:N})$.



Fig. 3. Copy rules for LIKE, the present and a dependency 1

Fig. 4 shows the complete execution of the system for the translation (3): the first stage uses only the bilingual lexicon without modifying the structure; the second stage (detailed in the lower part of the figure) carries out the restructuring. It should be noted that, in addition to the restructuring rule associated with Adv^1_2 and the copy rules, another rule makes it possible to create a link between two verbs if one of these verbs is associated with a modifier of the other verb. Such a rule amounts to authorizing a head switching during the translation the meaning, lexicalized as head of the sentence, is no longer the same.⁹ This rule is essential to allow the copy of the present tense from SWIM to LIKE and the restructuring when the verbs are embedded in a structure like *I think that Max likes to swim*.

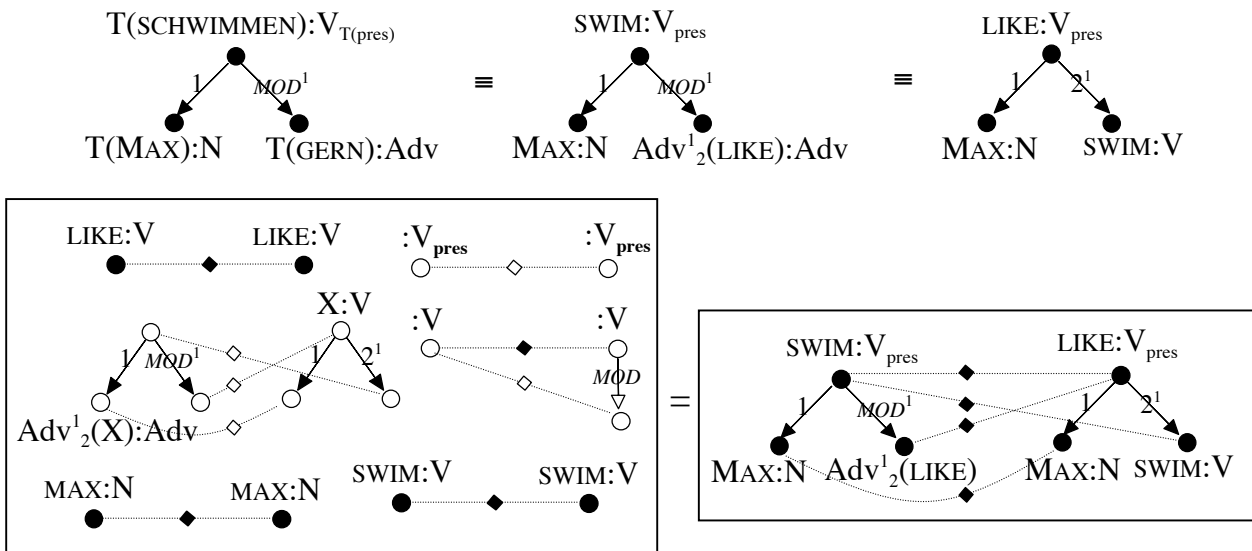

Fig. 4. The translation (4)

As shown, PUG gives us a simple way to combine the rules, only by merging black and white objects (that is nodes as well as correspondence links), and thus to write transfer rules.

5 Multiple restructurings

One of the most attractive properties of our formalism is that it allows taking into account multiple simultaneous restructurings. For the sake of simplicity, we will exemplify this by a monolingual example (which does not change anything to the problem):

- (5) a. *Max was sick for 2 weeks.*
- b. *Max's sickness lasted two weeks.*

⁹ We might indicate that this link is of secondary importance, blocking the transfer of actants between the two heads. The polarized correspondence grammars easily allow this by typing the links differently, contrarily to similar formalism such as synchronous grammars (Nesson et al. 2006) where correspondence links are encoded by co-indexation.

Two lexical rules are needed for this paraphrasing:

$$\begin{aligned} \text{SICK} &= \text{Adj}_1(\text{SICKNESS}:\text{N}) \\ \text{FOR} &= \text{Adv}_1(\text{LAST}:\text{V}) \end{aligned}$$

The Adj_1 function indicates that SICK is an Adj which has the same meaning that SICKNESS and whose governor is the 1st actant of SICKNESS. Idem for Adv_1 (the 2nd actant of LAST becomes the 2nd actant of FOR, which is a preposition, that is a “transitive” adverb). In addition, we introduce the lexical function Pred , which associates each adjective with a light verb, which is the copula for all English adjectives: $\text{Pred} = \text{BE}$. The paraphrase (5) is carried out by the following equivalence:

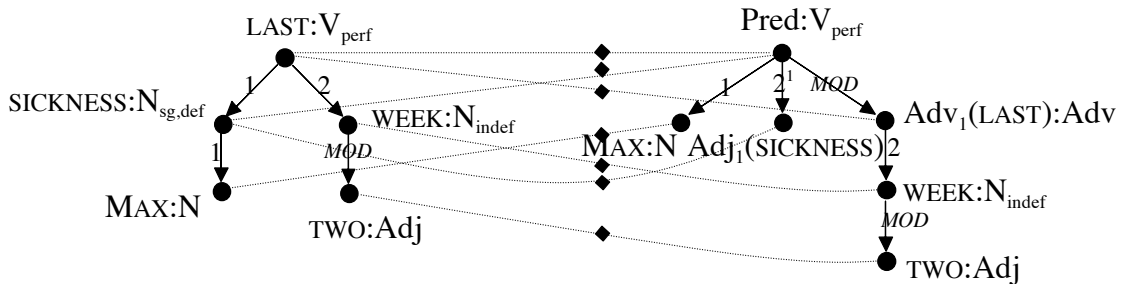

The transfer rules must apply simultaneously: it is not possible to change LAST by FOR and then SICKNESS by SICK, because at the same time as LAST becomes FOR, its first actant, which is a noun (SICKNESS), must become a verb (in fact it becomes an adjective, SICK, “transferred” into a verb by Pred). For this transfer, four restructuring rules will have to act jointly. The three first are the structural rules associated with the lexical functions Adj_1 , Adv_1 and Pred . The rules for Adj_1 and Adv_1 indicate that they are modifiers whose governor corresponds to the 1st actant of the key word; the rule for Pred associates an Adj with a verbal form whose 1st actant is the governor of the Adj. The last one is the head switching rule previously considered.¹⁰

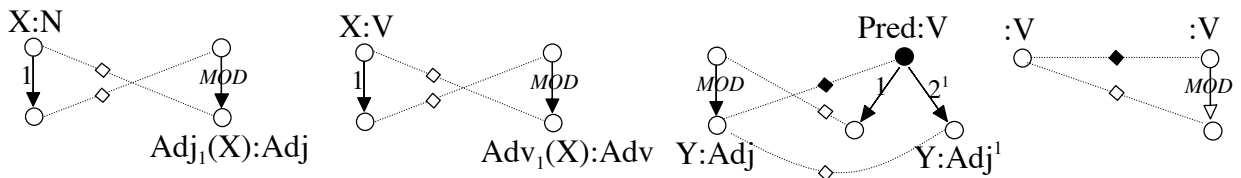

The rules associated with Adj_1 and Pred cannot be applied directly. They must be before combined together in order to construct a new rule allowing a direct transfer from the noun SICKNESS to the $\text{Pred}+\text{Adj}$ form BE SICK:

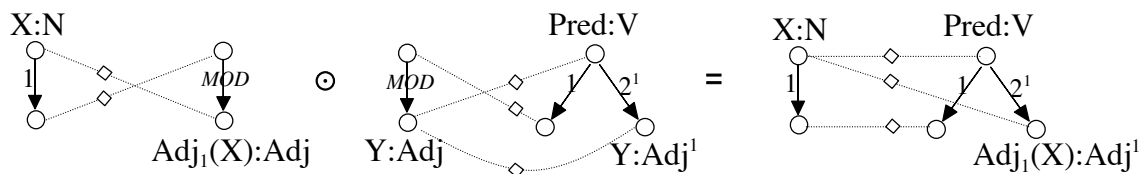

¹⁰ Changing the head strongly modifies the communicative structure of the sentence, considering that subject-verb partition often corresponds to a theme-rheme partition. Another reason for the difference of meaning between (5)a et b is that replacing an adjective by a noun entails to introduce a number and a determination on this noun, that is two new significant units (here singular and definite).

Structural rules and lexical functions thus form an algebraic system with an operation of composition, which we note \circ (Kahane & Polguère 2001). The composition of structural rules is ensured by “sticking” the left-hand part of the 1st rule on the 2nd one, as can be seen in the previous figure.

6 Motion verbs

Motion verbs illustrate a classical problem of translation between English and French:

- (6) a. *Zoe swam accross the river.*
 b. *Zoé a traversé la rivière à la nage* (litt. Zoe crossed the river in swimming_N)
- (7) a. *Zoe drove to the hospital.*
 b. *Zoé est allé à l'hôpital en voiture* (litt. Zoe went to the hospital in car)
- (8) a. *Max crawled out of the den.*
 b. *Max est sorti de la tanière en rampant* (litt. Max went_out of the den by crawling)

As known since the founding work of Talmy 1976, English is satellite-frame while French is verb-frame, that is English expresses the motion path by a satellite (and the motion manner by the verb governing it) while French uses the main verb for the motion path and a modifier for the manner. From the lexical point of view, this implies that verbs like SWIM and CRAWL, unlike their French equivalents NAGER and RAMPER, have a 2nd actant which is a locative complement. Consequently, when this 2nd actant is instantiated, the English verb cannot be translated into a French verb and a restructuring rule is needed for attributing this second actant to another element. This is done by the rule of Fig. 5 which puts the verb GO Y in place of the locative preposition Y at the same time as it puts an Adv¹⁺ in place of the motion verb X (that X is a motion verb ensures that the introduction of GO does not add any meaning). An Adv¹⁺ can be expressed by a present participle (Adv¹⁺(RAMPER:V) = *en rampant*). The symbol + indicates that the relation MOD is additional: there is no predicative relation between an Adv₊ and its governor; both of them form a co-predication. Some French motion verbs have a specific Adv¹⁺: Adv¹⁺(NAGER:V) = ‘À LA NAGE’, Adv¹⁺(CONDUIRE:V) = ‘EN VOITURE’.

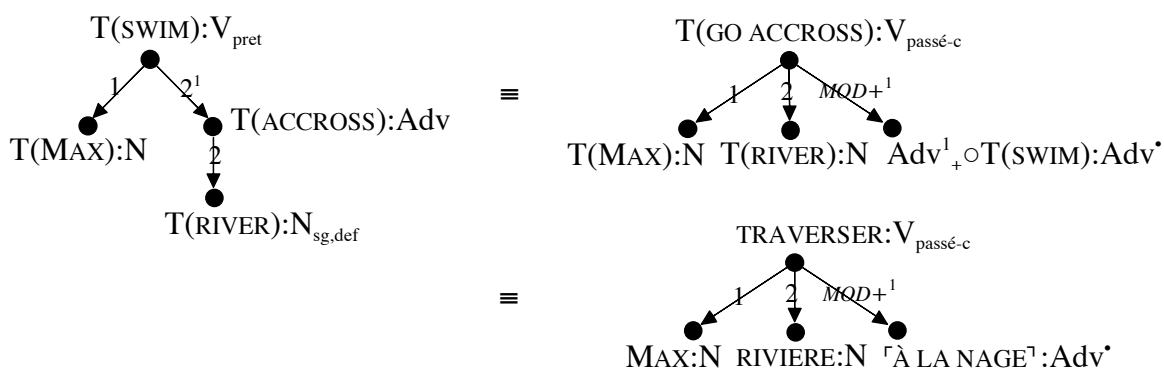
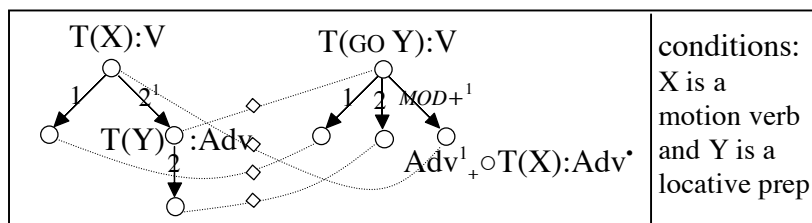

Fig. 5. Translation (6) and the corresponding restructuring rule.



Dorr 1994 argues that a straightforward transfer is impractical for such cases and proposes a solution using a deeper representation supposed to be an interlingua. Nasr *et al.* 1997 proposes a transfer-based solution using an underlying semantic decomposition of LUs and involving a specific rule for exchanging the semantic features path and manner. Our solution is simpler and our bilingual lexicon simply contains entries like (GO OUT:V, SORTIR:V), (GO ACROSS:V, TRAVERSER:V), (GO TO:V, ALLER (à/jusqu'à):V) and the restructuring rule of Fig. 5 allows these rules to apply in every case.

7 Conclusion

The architecture we adopted, following the first works in MT in the framework of MTT, is particularly economic: most of the rules used belong to the monolingual models (specially the description of collocations), restructuring rules are universal and the bilingual lexicon is minimized. Each restructuring rule is anchored by a syntactic lexical function which controls when this rule can be used, i.e. when the restructuring rule can combine with a correspondence between two LUs that is modeled by this lexical function in the monolingual or bilingual lexicons. The formalism of polarized correspondence grammars allows an elegant writing of the rules and an easy control of what is exactly handled by each rule.

Note that the transfer can be carried out directly at the SSynt level (e.g. Schubert 1987). But in this case, the transfer rules link portions of the SSyntSs, portions which correspond to a SU with its subcategorization. Such a mechanism (equivalent to a synchronous grammar like Ding & Palmer 2005 or Nesson et al. 2006) boils down to integrate the monolingual syntactic modules in the transfer module and makes the development of the bilingual lexicon a lot more expensive (which justifies that such lexicons are extracted automatically). (The use of a statistical model, although linked to the automatic extraction, is another question; it is clear that information about the frequency and the conditions of use of SUs are useful for a better fit of the translations.)

Acknowledgments

I thank Laurence Danlos, Kim Gerdes, Igor Mel'čuk and Alain Polguère and the three reviewers for many valuable comments on a preliminary version of this paper, as well as Leo Wanner and Igor Mel'čuk again for heated discussions about their work on the same topic.

References

- Abeillé A., Schabes Y., Joshi A. 1990. Using Lexicalized TAGs for Machine Translation, *Proceedings of COLING*, Helsinki, Finland, 1-6.
- Apresian J., Boguslavsky I., Iomdin L., Lazursky A., Sannikov V., Sizov V. & Tsinman L. 2003. ETAP-3 Linguistic Processor: a Full-Fledged NLP Implementation of the MTT, *Proceeding of MTT*, Paris, 279-288.
- Arnold D., des Tombes L. 1987. Basic theory and methodology in Eurotra. In S. Nirenburg (ed.), *Machine Translation: Theoretical and Methodological Issue*, Cambridge: Cambridge University Press, 114-135.
- Ding Y., Palmer M. 2005. Machine Translation Using Probabilistic Synchronous Dependency Insertion Grammars, *Proceedings of ACL*, Ann Arbor.

- Danlos D., Samvelian P. 1992. Translation of the predicative elements of a sentence: category switching and aspect, *Proceedings of Fourth International Conference on Theoretical and Methodological Issues in Machine Translation*, Montréal, Canada.
- Dorr, Bonnie J. 1994. Machine Translation Divergences: A Formal Description and Proposed Solution, *Computational Linguistics*, 20(4):597-633.
- Ducrot O. 1995. Les unités significatives [The significant units]. In Ducrot O. & J.-M. Schaeffer, *Nouveau dictionnaire encyclopédique des sciences du langage*, Seuil, 358-365.
- Goldberg A. 1995. *A Construction Grammar approach to argument structure*. Chicago: University of Chicago Press.
- Kahane S. 2003. On the status of the deep syntactic structure, *Proceedings of MTT*, Paris.
- Kahane S. 2006. Polarized Unification Grammar, *Proceedings of COLING-ACL*, Sydney.
- Kahane S., Lareau F. 2005. Meaning-Text Unification Grammar: modularity and polarity, *Proceedings of MTT*, Moscow, 23-32.
- Kahane S., Polguère A. 2001. Formal foundations of lexical functions, *Proceedings of the Workshop on Collocation, ACL*, Toulouse, 8 p.
- Kulagina O.S., Mel'čuk I.A. 1967. Automatic translation: some theoretical aspects and the design of a translation system, in A.D Booth (ed.) *Machine translation*, Amsterdam, North-Holland, 131-171.
- Lavoie B., Kittredge R. Korelsky T., Rambow O. 2000. A Framework for MT and Multilingual NLG Systems Based on Uniform Lexico-Structural Processing, *Proceedings of ANLP/NAACL 2000*, Seattle, Washington.
- Martinet A. 1960. *Éléments de linguistique générale*, Paris.
- Mel'čuk I. 1988a. *Dependency Syntax: Theory and Practice*, SUNY.
- Mel'čuk I. 1988b. Paraphrase et lexicque dans la théorie linguistique Sens-Texte — Vingt ans après, *Revue internationale de lexicologie et lexicographie*, Vol. 52/53, pp. 5-50/5-53.
- Mel'čuk I, Wanner L. 2006. Syntactic mismatches in machine translation, *Machine Translation*, 20(2):81-138.
- Nasr A., Rambow O., Palmer M., Rosenzweig J. 1997. Enriching Lexical Transfer With Cross-Linguistic Semantic Features. In *Proceedings of the AMTA/SIG-IL First Workshop on Interlingua*, San Diego, CA. Published as New Mexico State University Computing Research Laboratory technical report MCCA-97-314.
- Nesson R., Shieber S., Rush A. 2006. Induction of probabilistic synchronous tree-insertion grammars for machine translation. *Proceedings of the 7th Conference of the Association for Machine Translation in the Americas (AMTA)*, Boston, Massachusetts.
- Schubert K. 1987. *Metataxis: Contrastive Dependency Syntax for Machine Translation*. Dordrecht/Providence: Foris
- Talmy L. 1976. Semantic Causative Types, in M. Shibitani (ed.) *Syntax and Semantics 6: The Grammar of Causative Constructions*, Academic Press : N.Y, 43-116.
- Tesnière L. 1959. *Éléments de syntaxe structurale*, Paris: Klincksieck.
- Viegas E. 1997. Mismatches and divergences: the continuum perspective, *Proceedings of TMI*, Santa Fe.
- Žolkovskij A., Mel'čuk I. 1967. "O semantičeskom sinteze" [On the semantic synthesis (of texts)], *Problemy Kybernetiki*, 19:177-238. [French transl: 1970, *T.A. Information*, 2:1-85.]