



HAL
open science

Stationary ergodic Jackson networks: results and counter-examples

François Baccelli, Serguei Foss, Jean Mairesse

► **To cite this version:**

François Baccelli, Serguei Foss, Jean Mairesse. Stationary ergodic Jackson networks: results and counter-examples. Stochastic Networks: Theory and Applications, Oxford University Press, pp.281-307, 1996. hal-00165920

HAL Id: hal-00165920

<https://hal.science/hal-00165920>

Submitted on 30 Jul 2007

HAL is a multi-disciplinary open access archive for the deposit and dissemination of scientific research documents, whether they are published or not. The documents may come from teaching and research institutions in France or abroad, or from public or private research centers.

L'archive ouverte pluridisciplinaire **HAL**, est destinée au dépôt et à la diffusion de documents scientifiques de niveau recherche, publiés ou non, émanant des établissements d'enseignement et de recherche français ou étrangers, des laboratoires publics ou privés.

1

Stationary Ergodic Jackson Networks: Results and Counter-Examples

François Baccelli, Serguei Foss and Jean Mairesse

*INRIA Sophia-Antipolis, Novosibirsk State University and BRIMS
Hewlett-Packard Laboratories Bristol*

Abstract

This paper gives a survey of recent results on generalized Jackson networks, where classical exponential or i.i.d. assumptions on services and routings are replaced by stationary and ergodic assumptions. We first show that the most basic features of the network may exhibit unexpected behavior. Several probabilistic properties are then discussed, including a strong law of large numbers for the number of events in the stations, the existence, uniqueness and representation of stationary regimes for queue size and workload.

1 Introduction

Jackson networks provide a very effective mathematical model for packet switching networks. This paper gives a survey of recent results and a preview of ongoing research on *generalized* Jackson networks. Here the classical Markovian assumptions on services and routings, as proposed in Jackson's original model, are replaced by general stationary and ergodic assumptions.

Beyond the natural quest for a better mathematical understanding of such general stochastic networks, the interest in the non-Markovian case stems from two practical observations. First, it enables the incorporation of periodic phenomena, such as the dependence of random variables (services, routings) upon the period of the day or the year. Second, it was recently observed that in several basic communication networks (e.g. Ethernet LANs and the Internet), the point processes describing the offered traffic exhibit long range dependence [31], which rules out the classical Markovian representation.

The stability of Jackson networks has been considered in several papers. Without any claim to an exhaustive enumeration, one can cite the works of Jackson [19], Gordon and Newell [18], Borovkov [8, 9], Foss [16, 17], Daduna [14], Sigman [29, 30], Chang [11], Kaspi and Mandelbaum [20, 21] and Meyn and Down [25]. A more complete bibliography on the subject can be found in [17]. All these papers require some sort of independence assumptions or

The work of the last author was supported in part by a post-doctoral grant from INRIA.

some distributional constraints on services. By constructing counter-examples, the present paper first shows that under more general stationary and ergodic assumptions, all basic quantitative measures of the network may indeed exhibit unexpected behavior. The paper then focuses on positive results: strong laws of large numbers for the dates and counters associated to stations, existence and uniqueness of stationary regimes for the stochastic processes describing the queue sizes and the workloads, with detailed discussions on how these objects may depend on the initial condition. Finally, some special cases are investigated, with the aim of showing more detailed results on the classes of functions which are involved in the stationary regimes of such networks. The results are stated without proofs, the paper serving as a comprehensive review/preview of material to be found in: Baccelli and Foss [2, 3], Baccelli, Foss and Gaujal [4], Baccelli and Mairesse [6], Baccelli, Foss and Mairesse [5]. The counter-examples mentioned above, as well as several constructive results are original.

The main mathematical tools used are ergodic theory, random graphs, stochastic recurrence equations and stochastic ordering.

2 Definitions

2.1 Model

Definition 2.1 *A Jackson network is a queuing network with K stations, where each station is a single FIFO server with infinite buffer ($././1/\infty$ FIFO using Kendall's notation). Customers move from station to station in order to receive some service. The data are $(2K)$ sequences*

$$\{\sigma^i(n), n \in \mathbb{N}\}, \quad \{\nu^i(n), n \in \mathbb{N}\}, \quad i \in \{1, \dots, K\},$$

where $\sigma^i(n) \in \mathbb{R}^+$ and $\nu^i(n) \in \{1, \dots, K, K+1\}$, $K+1$ being the exit.

The n -th customer to be served by station i after the origin of time requires a service time $\sigma^i(n)$; after completion of its service there, it moves to station $\nu^i(n)$ and is put at the end of the line. We say that $\nu^i(n)$ is the n -th routing variable on station i .

Remark As far as results on throughputs or workload processes are concerned, we can replace FIFO by any non-preemptive, work conserving discipline.

We distinguish between two classes of Jackson networks, open and closed.

- **Open case:** There is an external arrival point process $\{T_n, n \in \mathbb{N}\}$, with $0 \leq T_0 \leq T_1 \leq \dots$. Equivalently, there is an additional saturated station (numbered 0) producing its first customer at time $\sigma^0(0) = T_0$, and further customers with inter-arrival times $\sigma^0(n) = T_n - T_{n-1}$, $n > 0$. The n -th external arrival is routed to station $\nu^0(n) \in \{1, \dots, K\}$. The description of the arrival process by means of station 0 is systematic throughout the paper. The customers eventually leave the network (see absence of capture below).
- **Closed case:** There are no external arrivals. It is impossible to be routed to the exit, i.e. $\nu^i(n) \in \{1, \dots, K\}, \forall i \in \{1, \dots, K\}, \forall n \in \mathbb{N}$. The total

number of customers in the network is then a constant.

Remark The previous definition of an open Jackson network includes the possibility of bulk arrivals.

It is convenient to denote by \mathcal{K} the set of stations of the network. We have in the open and closed cases respectively:

$$\mathcal{K} = \{0, 1, \dots, K\} \text{ and } \mathcal{K} = \{1, \dots, K\}. \quad (2.1)$$

Note that the exit, $K + 1$, is not considered as one of the stations in the open case. We use the notation $*$ with the convention that $*$ = 0 in the open case and $*$ = 1 in the closed case. For example, the set $\mathcal{K} \setminus *$ has to be interpreted as $\{1, \dots, K\}$ for an open network and $\{2, \dots, K\}$ for a closed network.

We use the following compact way of describing a Jackson network J .

$$J = \{(\sigma^k(n), k \in \mathcal{K}), (\nu^k(n), k \in \mathcal{K}), n \in \mathbb{N}\} \quad (2.2)$$

To unify the presentation, the number of customers (in the closed case) is not included in the definition of J but in the initial condition, to be defined below.

Definition 2.2. (Initial condition) For a Jackson network with K stations, we denote the initial condition by $(Q, R) = \{(Q^k, R^k), k = 1, \dots, K\}$. The integer Q^k is the number of customers in station k at time 0^- , $M = \sum_{k=1}^K Q^k$ is the total number of initial customers and R^k is the residual service time of the customer under service at station k at time 0^- . We adopt the convention $R^k = 0$ when $Q^k = 0$.

An initial condition is said to be finite if $Q^k < +\infty$ and $R^k < +\infty, k = 1, \dots, K$.

For an open network, the state of station 0 was not included in the above definition as it is always $(Q^0, R^0) = (\infty, T_0) = (\infty, \sigma^0(0))$.

We do not require that $R^k \leq \sigma^k(0)$. If $R^k > \sigma^k(0)$, one can interpret this as the fact that the first customer is frozen in station k until instant $R^k - \sigma^k(0)$ when its service starts.

We assume the initial condition to be deterministic. The case when Q^k and R^k are random variables is further discussed in [5].

Definition 2.3. (Canonical initial condition) We say that a Jackson network has a canonical initial condition if we have

- **Open case:** $\{(Q^k, R^k) = (0, 0), k = 1, \dots, K\}$. In words, the state at the origin of time is that all stations are empty.
- **Closed case:** $\{(Q^1, R^1) = (M, \sigma^1(0)), (Q^k, R^k) = (0, 0), k = 2, \dots, K\}$. In words, the state at the origin of time is that all customers are in station 1, and service 0 is just starting on station 1.

In the following, when nothing is specified, it is always implicit that the Jackson networks have canonical initial conditions. In order to avoid any confusion,

we use specific notations indexed by I (e.g. ${}_I J$, ${}_I J_{[0,n]}$, ${}_I X_{[0,n]}$, all quantities to be defined later on) for a network with a non-canonical initial condition I .

Let us define the sub-class of closed cyclic Jackson networks.

Definition 2.4 *A Cyclic Jackson Network (CJN) is a closed Jackson network, where for all n and i , $\nu^i(n) = i + 1$. The numbering of stations has to be understood modulo $[K]$, for example station $(K + 2)$ is station 2. The cycle time of a customer is the time between two consecutive visits to the same station.*

Remark Jackson networks are a sub-class of free-choice Petri nets. Cyclic Jackson Networks are a sub-class of closed event graphs. Free-choice Petri nets and event graphs are sub-classes of Petri nets, which provide an efficient formalism to represent and study discrete event systems with synchronization and/or routing, see for example Murata [26]. In [4], the method presented here for Jackson networks is applied to *open* free-choice Petri nets. Event graphs can be represented as $(\max,+)$ linear systems. It yields stronger results than those presented here for the sub-class of Jackson Networks which are event graphs (i.e. for CJN), see for example [1], [22].

2.2 Stochastic framework

Let (Ω, \mathcal{F}, P) be a probability space. We consider a bijective and bi-measurable shift function $\theta : \Omega \rightarrow \Omega$. We assume that θ is P -stationary (i.e. $P\{\theta^{-1}(\mathcal{A})\} = P\{\mathcal{A}\}, \forall \mathcal{A} \in \mathcal{F}$) and P -ergodic (i.e. $\mathcal{A} \subset \theta^{-1}(\mathcal{A}) \Rightarrow P\{\mathcal{A}\} = 0$ or 1). The symbols $\theta^n, n \geq 0$, denote the iterations of the shift θ (θ^0 is the identity). We use the notation $X \circ \theta$ to denote the r.v. $X \circ \theta(\omega) = X(\theta\omega), \omega \in \Omega$. A sequence of random variables $\{X(n), n \in \mathbb{N}\}$ is said to be stationary-ergodic (with respect to θ) if $X(n) = X(0) \circ \theta^n$.

Definition 2.5 *A Jackson network is said to be i.i.d. if the sequences of service times $\{\sigma^k(n), n \in \mathbb{N}\}$, $k \in \mathcal{K}$, and routings $\{\nu^k(n), n \in \mathbb{N}\}$, $k \in \mathcal{K}$, are i.i.d. and mutually independent.*

As suggested by the title of the article, we are interested in studying more general Jackson networks under stationary-ergodic assumptions. There are several possible definitions of stationary-ergodic Jackson networks, some of which are listed below in increasing order of generality.

- SE1** The sequences $\{\sigma^k(n), n \in \mathbb{N}\}$, $\{\nu^k(n), n \in \mathbb{N}\}$, $k \in \mathcal{K}$, are stationary-ergodic and mutually independent.
- SE2** The sequences $\{\sigma^k(n), k \in \mathcal{K}, n \in \mathbb{N}\}$ and $\{\nu^k(n), n \in \mathbb{N}\}$, $k \in \mathcal{K}$, are stationary-ergodic and mutually independent.
- SE3** The sequence $\{(\sigma^k(n), \nu^k(n), k \in \mathcal{K}), n \in \mathbb{N}\}$ is stationary-ergodic.

The stochastic assumptions we are going to work with are different yet again from from the previous three. They are defined in eqn (4.3) and denoted **H1**.

Routing matrix Let us consider a stationary-ergodic (**SE3**) Jackson network. We define its routing matrix as

$$P = (P_{ij}), \quad P_{ij} = P(\nu^i(0) = j), \quad i, j \in \mathcal{K}. \quad (2.3)$$

For an open Jackson network, we identify stations 0 and $K + 1$, setting $\mathbb{P}_{i0} = P(\nu^i(0) = K + 1), i = 1, \dots, K$. Note that this definition of \mathbb{P} boils down to the usual one in the case of an i.i.d. network.

In the following, it is always assumed that a Jackson network is at least stationary-ergodic (**SE3**). Furthermore, it is always assumed that a Jackson network has an irreducible routing matrix \mathbb{P} (i.e. $\forall i, j, \exists n \in \mathbb{N}$ s.t. $\mathbb{P}_{ij}^n > 0$). In the open case, the irreducibility of matrix \mathbb{P} implies that the system is without capture, i.e. a customer entering the system eventually leaves it.

Remark When the previous assumptions are not verified, one should study separately the maximal irreducible sub-networks. The departure processes from upstream sub-networks provide the arrival processes for downstream ones. Accordingly, to connect together the results obtained for the different sub-networks, one needs to prove that these departure processes are stationary and ergodic. This is partially addressed in §8. For more insights, see also [4] and [5].

Letting α be a left-eigenvector associated with the maximal eigenvalue of \mathbb{P} , we have

$$\alpha \mathbb{P} = \alpha. \quad (2.4)$$

It follows from the Perron-Frobenius theorem that α is unique (up to a constant) and can be chosen to be positive ($\forall i, \alpha_i > 0$). We choose α such that $\alpha_* = 1$. The real α_k can be interpreted as the relative frequency of visits to stations k and $*$.

Periodic networks By definition, a Jackson network is *periodic* if the sequences of services and routings are periodic. Periodic Jackson networks can be transformed into stationary-ergodic (usually **SE3**) Jackson networks, as shown below.

Example 2.6 Let us consider a closed periodic network with two stations. We have

$$\sigma^1(n) = 0, 3, 0, 3, \dots, \sigma^2(n) = 5, 5, 5, \dots, \nu^1(n) = 1, 2, 1, \dots, \nu^2(n) = 2, 1, 2, \dots$$

This network does not satisfy the stationary ergodic assumptions.

Let (Ω, \mathcal{F}, P) be the probability space with $\Omega = \{\omega_1, \omega_2\}$ and $P(\omega_1) = P(\omega_2) = 1/2$. We consider the P -stationary and P -ergodic shift defined by $\theta(\omega_1) = \omega_2, \theta(\omega_2) = \omega_1$. We define a new network on Ω with services and routings equal to

$$\begin{aligned} \sigma^1(n, \omega_1) &= 0, 3, 0, \dots, \sigma^2(n, \omega_1) = 5, \nu^1(n, \omega_1) = 1, 2, 1, \dots, \nu^2(n, \omega_1) = 2, 1, 2, \dots \\ \sigma^1(n, \omega_2) &= 3, 0, 3, \dots, \sigma^2(n, \omega_2) = 5, \nu^1(n, \omega_2) = 2, 1, 2, \dots, \nu^2(n, \omega_2) = 1, 2, 1, \dots \end{aligned}$$

It is easy to verify that this network is stationary and ergodic (**SE3**).

In general, one builds a stationary-ergodic version of a periodic Jackson network by considering a finite probability space whose cardinal is the *least common multiple* of the periods of the sequences of services and routings.

2.3 First and second order variables

We describe Jackson networks using daters and counters.

Definition 2.7 We define the internal dater $X^k(n)$, $k \in \mathcal{K}$, to be the time at which the n -th service is completed at station k . We define the internal counter $\mathcal{X}^k(t)$, $k \in \mathcal{K}$, to be the number of services completed at station k before time t . And last, we define $\mathcal{X}^{k,l}(t)$, $k, l \in \mathcal{K}$ to be the number of customers routed from k to l before time t . The counters are chosen to be right continuous with left-hand limits.

We are going to study two types of variables, called respectively first and second order variables.

First order variables Counters and daters are called first order variables. Properly scaled, they may converge to throughputs. The throughput at station k (when it exists) is equal to

$$\lambda^k = \lim_{n \rightarrow \infty} n/X^k(n) = \lim_{t \rightarrow \infty} \mathcal{X}^k(t)/t.$$

The arrival rate in the network is $\lambda^0 = \lim_{t \rightarrow \infty} \mathcal{X}^0(t)/t$. The departure rate (when it exists) is $\lambda^{K+1} = \lim_{t \rightarrow \infty} \mathcal{X}^{K+1}(t)/t$.

Second order variables They include queue length, residual service time, and workload processes. They are called second order variables because they can be defined as differences of counters and daters, as shown below. All processes are chosen to be right continuous with left-hand limits.

- (1) Queue length and residual service time process:
 $(Q^k(t), R^k(t), k \in \mathcal{K} \setminus 0), t \in \mathbb{R}^+$, with
 $Q^k(t) = Q^k + \sum_{l \in \mathcal{K}} \mathcal{X}^{l,k}(t) - \mathcal{X}^k(t)$ and $R^k(t) = [X^k(\mathcal{X}^k(t)+1) - t] 1_{\{Q^k(t) > 0\}}$.
 We have $(Q(0), R(0)) = (Q, R)$ where (Q, R) is the initial condition.
- (2) Workload process:
 $(W^k(t), k \in \mathcal{K} \setminus 0), t \in \mathbb{R}^+$, with $W^k(t) = [X^k(\mathcal{X}^k(t) + Q^k(t)) - t] \vee 0$. Dually, one can consider the idle time processes $I^k(t) = [t - X^k(\mathcal{X}^k(t) + Q^k(t))] \vee 0$.

Here are different properties that we would like to investigate:

- (A) Existence of throughputs λ^k , $k \in \mathcal{K}$, for a given initial condition (Def. 2.2)?
- (B) Uniqueness of the throughputs λ^k , $k \in \mathcal{K}$, for all different initial conditions?
 For an open network, this uniqueness has to be verified for any finite initial condition, see Def. 2.2. For a closed network, this uniqueness has to be verified for all finite initial conditions such that $\sum_{k=1}^K Q^k = M$ for some M (i.e. the number of customers is fixed).
- (C) Concavity of the throughputs $\lambda^k(M)$, $k \in \mathcal{K}$, as a function of the number M of customers in the network? This property is of course irrelevant for open networks.
- (D) Existence of stationary regimes for second order processes? Uniqueness of the stationary regimes for different initial conditions (see property (B) for a precise statement)?

The answers to these questions are summarized in the following table, where the assumptions which are considered are **H1-2**, see eqn (4.3):

Table 1.

.	Open network	Closed network
A	Yes	Yes
B	Yes	No
C	—	No
D	No	No

3 Counter-Examples

We provide counter-examples for all the cases corresponding to an answer “No” in Table 1. The networks considered in these counter-examples are periodic networks. The reader can check that the counter-examples remain valid if we replace these networks by their stationary and ergodic extensions (the initial conditions being kept unchanged), see §2.2. Note also that all these networks (or rather their extensions) satisfy the forthcoming assumption **H1**, see eqn (4.3). It is a direct consequence of the cyclic form for the networks of §3.2, 3.3 and 3.4 and it can be checked directly for the network of §3.1.

3.1 Open network, non-uniqueness of second order limits (D)

We consider an open Jackson network with two stations. The stations can be described as $. / D / 1 / \infty$ FIFO, using Kendall’s notation. Here D stands for Deterministic. The service times are $\sigma^1(n) = \sigma^1 = 1/4$ and $\sigma^2(n) = \sigma^2 = 1/2$. The input process is $\{T_n = n + 1, n \in \mathbb{N}\}$, i.e. one customer arrives each unit of time. The routing sequence of customers leaving station 1 is

$$\nu^1(n) = \{3, 2, 3, 2, 3, \dots\},$$

where 3 corresponds to the exit. This network is represented in Fig. 1.

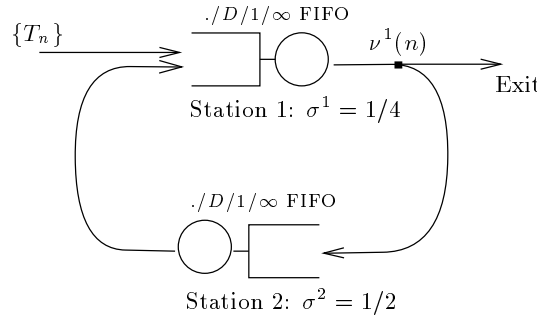

FIG. 1. Open Jackson network with two stations.

Let us show that we obtain several stationary regimes. We fix $1 < c < 1 + \sigma^1$. We consider an initial condition of the form $(Q^1, R^1) = (1, c), (Q^2, R^2) = (0, 0)$, i.e. there is one customer in station 1 with residual service time c .

We have represented, in Fig. 2, the Gantt chart corresponding to this network

for $c = 1 + 1/8$. The horizontal axis represents time. The blocks correspond to the time spent by the customers in the stations. The colors of the blocks depend on the customer. For example, *black* corresponds to the initial customer and *light gray* to the customer arriving at instant $T_0 = 1$. It follows from the periodicity of $\nu^1(n)$ that each customer (except the initial one) receives exactly two services at station 1 and one at station 2.

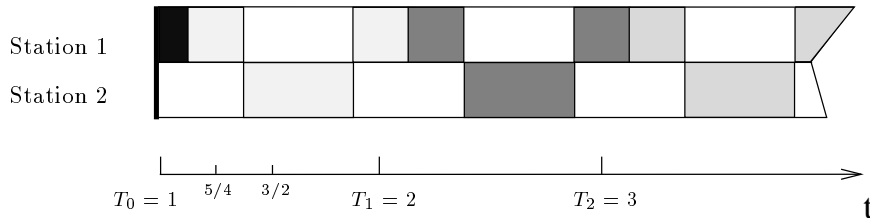

FIG. 2. Initial condition $(Q^1, R^1) = (1, 9/8), (Q^2, R^2) = (0, 0)$.

We recall that $W^1(t)$ is the workload at station 1 at instant t . Using Fig. 2, one can easily see that $\max_t W^1(t) = 1/4 + (c - 1) = W^1(n), n \in \mathbb{N}$. We conclude that there is a continuum of possible stationary regimes for the workload, depending on c .

Remark This counter-example was first mentioned in [4]. The phenomenon of multiplicity of second order limits appears in other types of open networks. A folk example consists of a multiserver queue of the form $D/P/2/\infty$ where arriving customers are allocated to the server with the smallest workload. For more details, see for example Brandt, Franken and Lisek, [10] Example 5.5.2.

3.2 Closed network, non-uniqueness of second order limits (D)

We consider a Cyclic Jackson Network (CJN) with three stations and two customers. The stations are of type $.D/1/\infty$ FIFO. The service times are $\sigma^1(n) = \sigma^2(n) = \sigma^3(n) = 1$. This network is represented in Fig. 3.

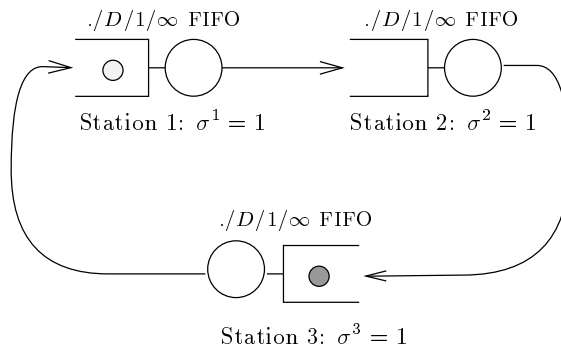

FIG. 3. Cyclic Jackson Network, three stations and two customers.

In Fig. 4 and 5, the Gantt charts corresponding to two different initial conditions are given. The color of the blocks differs according to the customer served, *light gray* is for the customer originally in station 1 and *dark gray* for the one originally in station 3, see Fig. 3.

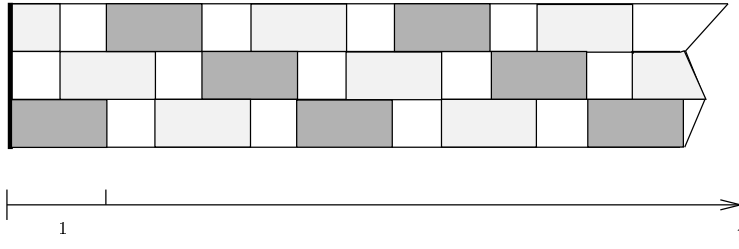

FIG. 4. Initial condition $(Q^1, R^1) = (1, 1/2), (Q^2, R^2) = (0, 0), (Q^3, R^3) = (1, 1)$.

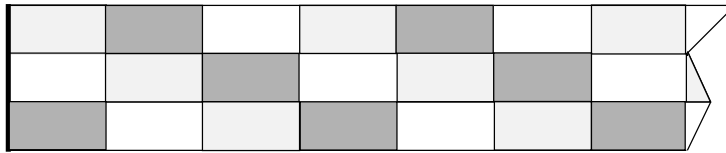

FIG. 5. Initial condition $(Q^1, R^1) = (1, 1), (Q^2, R^2) = (0, 0), (Q^3, R^3) = (1, 1)$.

Let us consider for example the idle time $\{I^1(t)\}$ at station 1. For the initial conditions corresponding to Fig. 4 and 5, we obtain $\{I^1(n) = 1/2, 1/2, 1/2, \dots\}$ and $\{I^1(n) = 0, 1, 0, 1, \dots\}, n \in \mathbb{N}$, respectively. It is easy to see that there is a continuum of possible limiting regimes for $I^1(t)$ depending on the initial condition.

In such a deterministic model, initial delays between customers never vanish. In fact, even first order limits may depend on the initial condition, see next section.

Remark Such counter-examples are well-known in the literature. In fact, a complete classification of CJN having multiple second order stationary regimes can be made using the $(\max, +)$ theory, see [22, 23].

3.3 Closed network, non-uniqueness of the throughput (B)

We consider a CJN with four stations and two customers. The stations are of type $. / P / 1 / \infty$ FIFO, where P stands for Periodic. The service times are

$$\sigma^1(n) = 2, 0, 2, 0, \dots, \sigma^2(n) = 1, \sigma^3(n) = 0, 2, 0, 2, \dots, \sigma^4(n) = 1.$$

We consider the network under two different initial conditions, see Fig. 6. The first one is with one customer in station 1 and one in station 3. The second one is with both customers in station 1. We have represented the corresponding

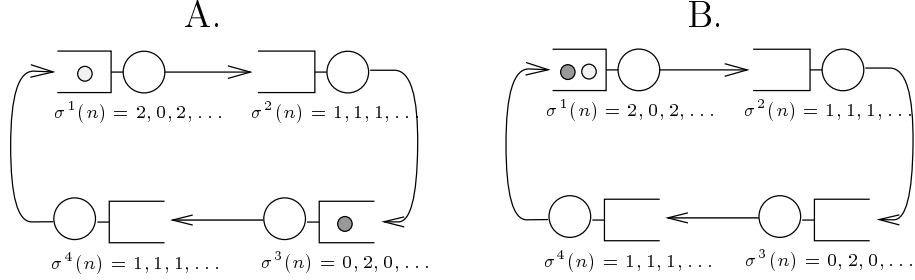
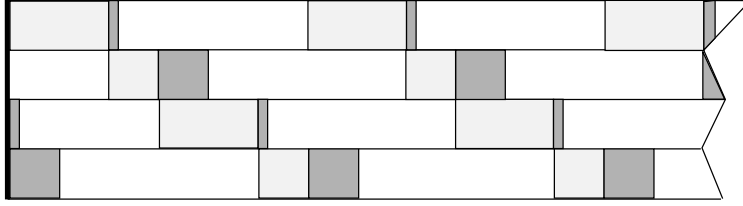
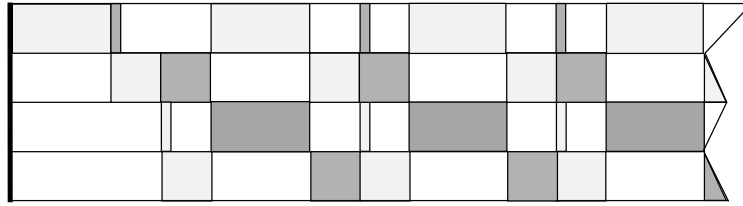

FIG. 6. CJN, four stations and two customers.

Gantt charts in Fig. 7 and 8 respectively. For convenience, service times equal to 0 have been materialized and represented by slim bars.

FIG. 7. $(Q^1, R^1) = (1, 2)$, $(Q^2, R^2) = (0, 0)$, $(Q^3, R^3) = (1, 0)$, $(Q^4, R^4) = (0, 0)$.FIG. 8. $(Q^1, R^1) = (2, 2)$, $(Q^2, R^2) = (0, 0)$, $(Q^3, R^3) = (0, 0)$, $(Q^4, R^4) = (0, 0)$.

In Fig. 7, the throughput is $1/3$. In Fig. 8, the throughput is $1/2$. We conclude that the throughput depends on the initial position of customers.

In Fig. 7, the *light gray* customer always receives long services and the *dark gray* customer always waits before getting served. In Fig. 8, services and waiting times are more equally shared between the two customers. It increases the efficiency of the network.

Remark This example was first introduced in [23], Chap. 8. A closely related counter-example is displayed by Bambos in [7]. His model is a CJN with distinguishable customers. It means that the service times depend on the station *and* on the customer. For each couple station-customer, the sequence of service times

is periodic. As customers do not overtake, the cyclic ordering of customers in the network is an invariant. It is shown in [7], that the throughput may depend on the cyclic ordering but also on the initial positioning of customers given a cyclic ordering. This last result is close but slightly different from the one illustrated in Fig. 7 and 8. Let us explain why.

We fix a cyclic ordering of customers. For a given initial positioning of customers, we can define the sequence $\{s^i(n), n \in \mathbb{N}\}$ of services received at station i . It is easy to see that $\{s^i(n)\}$ is periodic. The difference with our model is that the sequences $\{s^i(n)\}$ depend on the initial position of customers. For another initial position, we will obtain sequences of the form $\{s^i(n + k_i), n \in \mathbb{N}\}$.

3.4 Closed network, non-concavity of the throughput (C)

We investigate the behavior of the network with respect to the number of customers. We consider the network of Fig. 6.A and we add a second customer in station 1. The new Gantt chart is represented in Fig. 9.

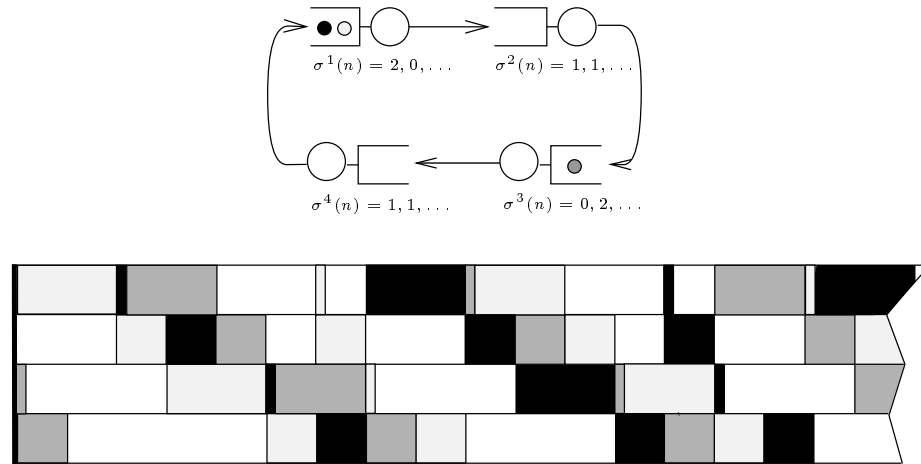

FIG. 9. CJN, four stations and three customers. Initial condition $(Q^1, R^1) = (2, 2), (Q^2, R^2) = (0, 0), (Q^3, R^3) = (1, 0), (Q^4, R^4) = (0, 0)$.

The average cycle time (see Def. 2.4) of a customer is $21/4 = 5.25$. For example, the cycle time of the *light gray* customer computed from station 2 to station 2 is $\{4, 5, 6, 6, 4, 5, 6, 6, \dots\}$.

Comparing Fig. 7 and 9, one checks that the average cycle time of the original two customers has decreased from 6 to 5.25. The addition of one customer has increased the speed of the original customers!

For the purpose of this example, let us introduce some notation. We consider a network with M customers. We denote by $\gamma(M)$ the cycle time of a customer

and by $\lambda(M)$ the throughput (which is the same at each station). We have

$$\lambda(M) = M/\gamma(M).$$

In the previous example, we have obtained $\gamma(3) < \gamma(2)$. It implies $\lambda(3)/3 > \lambda(2)/2$. We conclude that there is no concavity of the throughput.

We have represented in Fig. 10, the throughput $\lambda(M)$ for the network of Fig. 9. For $M > 2$, each new customer is added in the buffer of station 1. When M becomes large, we obtain the expected behavior, i.e. the throughput becomes constant and is imposed by the bottleneck (slowest) station(s).

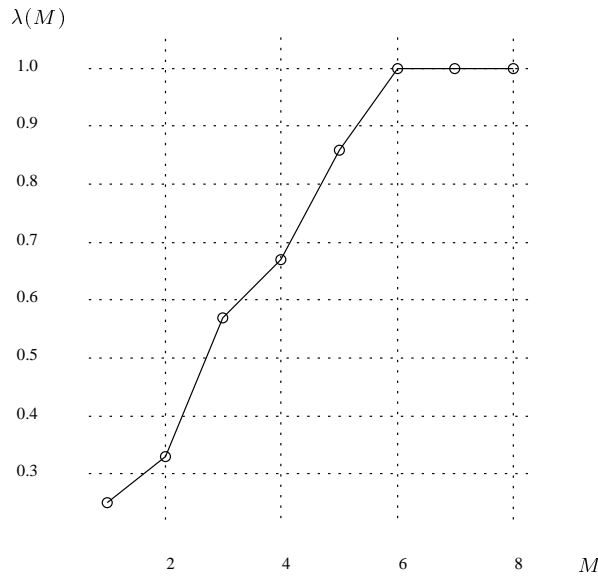

FIG. 10. Throughput $\lambda(M)$ as a function of the number of customers M .

In contrast, we can consider the same network with all the customers in station 1. In this case, we obtain the expected behavior, i.e. the cycle time $\gamma(M)$ is an increasing function of M .

Remark To the best of our knowledge, this kind of counter-example is original. A similar paradox is provided by the network of Braess, studied in Cohen and Kelly [13]. It is a transportation network where the withdrawal of one of the existing routes increases the speed of all the customers. However, the two models are completely different. Braess model is that of an open congested network with optimal routing. The paradox comes from the non compatibility between customer optima and global optima, in a game theoretic sense. Our model is closed, uncongested and with a predetermined routing. The paradox comes from the (in)compatibility between the number of customers and the periods of the sequences of service times.

Summary The best we can expect to prove is the complement of the previous counter-examples. More precisely, we propose in Table 2, a new detailed version of Table 1, with the sections where the positive results are stated.

		<i>Open network</i>		<i>Closed network</i>	
		<i>i.i.d.</i>	<i>stat. erg.</i>	<i>i.i.d.</i>	<i>stat. erg.</i>
Table 2.	A	Yes §5.2	Yes §5.2	Yes §5.1	Yes §5.1
	B	Yes §6.3	Yes §6.3	Yes §6.2	No §3.3
	C	—	—	???	No §3.4
	D	Yes §8.1	No §3.1	No §3.2	No §3.2

4 Restriction of a Jackson Network

4.1 Euler property

Let J be a Jackson network. We associate with J a random graph G , called the routing graph which is defined from the information carried by the routing sequences only. The set of nodes of G is \mathcal{K} and a routing $\{\nu^i(n) = j\}$ is interpreted as an arc labeled n from node i to node j . In the open case, a routing $\{\nu^i(n) = K + 1\}$ is interpreted as an arc from node i to node 0. If $(i, j) \in \mathcal{K}^2$ is such that $P_{ij} > 0$ (see (2.3)), then there is an infinite number of arcs from i into j . The arcs originating from a given node are totally ordered by the labels. An initial condition for the graph is defined as a finite number of tokens placed on the nodes. Each node might contain several tokens.

Definition 4.1. (Game \mathcal{G}) *Given a routing graph G and an initial condition, we move the tokens according to the following rules*

- *Step 1: Select one of the tokens, say one on node i , and move it to node $\nu^i(0)$. Remove the arc $\{\nu^i(0)\}$.*
- *Step $n > 1$: Select one of the tokens, say one on node i , and move it to node $\nu^i(p)$ where $\{\nu^i(p)\}$ is the arc originating from i with the lowest label. Remove the arc $\nu^i(p)$.*
- *Termination rule: Each time a token **returns** to station $*$, it is frozen there and cannot be considered for further moves. Equivalently, there is a step 0 for the game which consists of removing the arcs $\nu^*(I^*), \nu^*(I^* + 1), \dots$, where I^* is the initial number of tokens in station $*$.*

A sequence of moves following the previous rules is called an execution of game \mathcal{G} . The game ends when there are no unfrozen tokens left in the network. We denote by T the step at which the game ends.

This game can in some sense be interpreted as an untimed version of the evolution of the Jackson network. There are of course several possible executions of the game depending on which token is selected at each step. In the closed case, given an execution of the game, it is easy to build sequences $\{(\tilde{\sigma}^k(n), k \in \mathcal{K}), n \in \mathbb{N}\}$ of service times such that the Jackson network $\{(\tilde{\sigma}^k(n), \nu^k(n))\}$ evolves exactly as \mathcal{G} . In the open case, it would be necessary to allow the addition or removal of tokens to obtain the same interpretation.

Proposition 4.2. (Euler property) *Let J be a stationary and ergodic (SE3) Jackson network. Let G be the corresponding routing graph. Let us consider a finite initial condition for G . For all executions of the game \mathcal{G} , the game ends in finite time, i.e. $T < \infty$. Furthermore both T and the set of arcs of G which are not removed at time T do not depend on the execution.*

Proof The key ingredient is the irreducibility of the routing matrix \mathcal{P} . A proof was proposed in [2] under (H_1) type conditions. For a proof under (SE3), see [5]. \square

4.2 Restriction of a network

Let J be a Jackson network. For all integers $l \geq 0$, we define the Jackson network

$$J_{[0,l]} = \left\{ (\sigma_{[0,l]}^k(n), k \in \mathcal{K}), (\nu_{[0,l]}^k(n), k \in \mathcal{K}) \right\}, \quad (4.1)$$

where

$$\sigma_{[0,l]}^*(n) = \begin{cases} \sigma^*(n) & \text{for } 0 \leq n \leq l \\ \infty & \text{otherwise} \end{cases},$$

and $\sigma_{[0,l]}^k(n) = \sigma^k(n), \forall n \geq 0, \forall k \in (\mathcal{K} \setminus *)$ and $\nu_{[0,l]}^k(n) = \nu^k(n), \forall n \geq 0, \forall k \in \mathcal{K}$.

We say that $J_{[0,l]}$ is a *restriction* of J . The intuitive interpretation is that we block station $*$ after l services there.

In a consistent way with the notations of Def. 2.7, we denote the dates and counters associated with the network $J_{[0,l]}$ by $X_{[0,l]}^k(n)$ and $\mathcal{X}_{[0,l]}^k(t)$. We define the *maximal dates* associated with the network $J_{[0,l]}$ as

$$X_{[0,l]}^k = \max_{n \geq 0} X_{[0,l]}^k(n), \quad X_{[0,l]} = \max_{k \in \mathcal{K}} X_{[0,l]}^k, \quad (4.2)$$

where the maxima are taken over the finite terms only. It follows from Prop. 4.2 that $X_{[0,l]}$ is finite P -a.s. The interpretation is that $X_{[0,l]}$ is the date of the last event to take place in $J_{[0,l]}$. Let us define

$$l_{[0,l]}^k = \lim_{t \rightarrow \infty} \mathcal{X}^k(t) = \mathcal{X}^k(X_{[0,l]}), \quad l_{[0,l]} = \sum_{k \in \mathcal{K}} l_{[0,l]}^k.$$

The integer $l_{[0,l]}^k$ is the total number of services completed at station k until instant $X_{[0,l]}$ (or equivalently until ∞). By definition, we have $l_{[0,l]}^* = l + 1$. It follows from Prop. 4.2 that $l_{[0,l]}^k$ is finite and depends only on the routings, not on the services.

We define the following notations.

- Services used up to time $X_{[0,l]}$:

$$\sigma_{[0,l]}^k = (\sigma^k(0), \dots, \sigma^k(l_{[0,l]}^k - 1)), \quad \sigma_{[0,l]} = (\sigma_{[0,l]}^k, k \in \mathcal{K}).$$

- Routings used up to time $X_{[0,l]}$:

$$\nu_{[0,l]}^k = (\nu^k(0), \dots, \nu^k(l_{[0,l]}^k - 1)), \quad \nu_{[0,l]} = (\nu_{[0,l]}^k, k \in \mathcal{K}).$$

- Total service time received up to time $X_{[0,l]}$:

$$\|\sigma_{[0,l]}^k\| = \sum_{i=0}^{l_{[0,l]}^k-1} \sigma^k(i), \quad \|\sigma_{[0,l]}\| = \sum_{k \in \mathcal{K}} \|\sigma_{[0,l]}^k\|.$$

For all $l \geq 0$, we define the Jackson network

$$J_{[l,\infty]} = \left\{ (\sigma_{[l,\infty]}^k(n), k \in \mathcal{K}), (\nu_{[l,\infty]}^k(n), k \in \mathcal{K}), n \in \mathbb{N} \right\},$$

where $\sigma_{[l,\infty]}^k(n) = \sigma^k(n + l_{[0,l-1]}^k)$ and $\nu_{[l,\infty]}^k(n) = \nu^k(n + l_{[0,l-1]}^k)$, $k \in \mathcal{K}$ (with the convention $l_{[0,-1]}^k = 0$).

The interpretation is that $J_{[l,\infty]}$ is the network obtained by unblocking $J_{[0,l-1]}$ after instant $X_{[0,l-1]}$.

The definition of the restricted networks $J_{[l,p]}$, $l \leq p$, follows naturally. The notations used for quantities associated with $J_{[l,p]}$ are consistent with the previous ones. For example, we denote the internal dates of $J_{[l,p]}$ by $X_{[l,p]}^k(n)$.

For convenience, we use the following abridged notation $J_{[p]} = J_{[p,p]}$ and accordingly $X_{[p]} = X_{[p,p]}$, $X_{[p]}^k(n) = X_{[p,p]}^k(n), \dots$

Remark The restrictions $J_{[l,p]}$ are defined as Jackson networks, and the conventions of Section 2.1 will be used without further mention. It implies that $J_{[l,p]}$ starts its evolution at time 0 and not at time T_l or $X_{[0,l-1]}$.

Example 4.3 Let us consider the closed Jackson network of Fig. 6.B. We have

$$\begin{aligned} l_{[i]} &= 4, & \nu_{[i]} &= \{\nu_{[i]}^1, \dots, \nu_{[i]}^4\} = \{2, 3, 4, 1\}, \\ \sigma_{[i]} &= \{\sigma_{[i]}^1, \dots, \sigma_{[i]}^4\} = \{2, 1, 0, 1\}, i \text{ even}, & \sigma_{[i]} &= \{0, 1, 2, 1\}, i \text{ odd}. \end{aligned}$$

Note that in this case, the stations visited and the services received by a customer in the networks J and $J_{[i]}$ are the same. One can easily convince oneself that it is not the case as soon as the routings allow customers to overtake.

4.3 Stochastic assumptions

We consider a probability space $(\Omega, \mathcal{F}, P, \theta)$ as defined in §2.2. The main forthcoming results (Sections 5,6,7) are to be given under the following stochastic assumptions :

- **H1** The sequence $\{(\sigma_{[i]}, \nu_{[i]}) = (\sigma_{[i]}^k, \nu_{[i]}^k), k \in \mathcal{K}, i \in \mathbb{N}\}$ is stationary and ergodic, i.e. we have

$$(\sigma_{[i]}, \nu_{[i]}) = (\sigma_{[0]}, \nu_{[0]}) \circ \tilde{\theta}^i, \quad (4.3)$$

for some P -stationary and P -ergodic shift $\tilde{\theta}$.

- **H2** The total service time received in $J_{[0]}$ is integrable, i.e. $E(\|\sigma_{[0]}\|) < +\infty$.

Note that these assumptions are made on the quantities associated with the restricted networks $J_{[i]}$. They may not seem natural at first glance. All the

results to come will show that they are the right ones, see Remark 6.2. The following lemma gives simple sufficient assumptions on J under which the above assumptions are satisfied (see [5]).

Lemma 4.4 *Let us consider a Jackson network J such that the sequences $\{(\sigma^k(n)), n \in \mathbb{N}\}, k \in \mathcal{K}$, are stationary-ergodic and mutually independent and the sequences $\{\nu^k(n), n \in \mathbb{N}\}, k \in \mathcal{K}$, are i.i.d., mutually independent and independent of the services. Then $\{(\sigma_{[p]}, \nu_{[p]}), p \in \mathbb{N}\}$ is a stationary and ergodic sequence.*

The previous lemma fails to be true if we only assume that $\{(\sigma^k(n), k \in \mathcal{K}), n \in \mathbb{N}\}$ is stationary-ergodic.

5 First Order Limits for Canonical Initial Conditions (A)

It is easy to prove, see [5], that α_k , defined in (2.4), is also the expected number of visits to station k in $J_{[0]}$:

$$\alpha_k = E(l_{[0]}^k). \quad (5.1)$$

5.1 Closed network

Theorem 5.1 *Let J be a closed Jackson network. Under the assumptions **H1-2**, we have for all $k \in \mathcal{K}$:*

$$\begin{aligned} \lim_{n \rightarrow \infty} \frac{n}{X^k(n)} &= \lim_{t \rightarrow \infty} \frac{\mathcal{X}^k(t)}{t} = \alpha_k \lambda, \quad P - a.s. \\ \lim_{n \rightarrow \infty} E\left(\frac{n}{X^k(n)}\right) &= \lim_{t \rightarrow \infty} E\left(\frac{\mathcal{X}^k(t)}{t}\right) = \alpha_k \lambda, \end{aligned}$$

for some constant λ and where α_k is defined in (2.4) or (5.1).

Proof The proof is based on the sub-additivity of the maximal daters $\mathcal{X}_{[m,n]}$. It is given in [5]. \square

5.2 Open network

Let J be a Jackson network verifying assumptions **H1-2**. We define $J\{0\}$ to be the Jackson network obtained from J by modifying only the arrival process and setting $T_n = 0, \forall n \geq 0$. In words, $J\{0\}$ is the saturated network associated with J . We define, with obvious notations, the quantities $X^k(n)\{0\}, \mathcal{X}^k(t)\{0\} \dots$

Theorem 5.2 *Under the previous assumptions, there exists a constant $\lambda(0)$ such that*

$$\lim_{t \rightarrow \infty} \frac{\mathcal{X}^{K+1}(t)\{0\}}{t} = \lambda(0), \quad P - a.s. \text{ and in } L_1. \quad (5.2)$$

The constant $\lambda(0)$ is the asymptotic throughput of departures from the network $J\{0\}$. Furthermore, we have:

$$1/\lambda(0) = \max_{k=1, \dots, K} E\left(\|\sigma_{[0]}^k\|\right).$$

We recall that $\|\sigma_{[0]}^k\|$ is the total service time received at station k in $J_{[0]}$.

Proof The first proofs were given in [2] and [4]. A shorter proof will appear in [5]. \square

Theorem 5.3 *Let J be an open Jackson network verifying assumptions **H1-2**. Let $\lambda(0)$ be the constant defined in (5.2). We assume that $\lambda^0 < \lambda(0)$. We have for all $k \in \mathcal{K} \cup \{K+1\}$:*

$$\lim_{n \rightarrow \infty} \frac{n}{X^k(n)} = \lim_{t \rightarrow \infty} \frac{\mathcal{X}^k(t)}{t} = \alpha_k \lambda^0, \quad P - a.s. \text{ and in } L_1,$$

where $\alpha_k, k \in \mathcal{K}$, is defined in (2.4) and where $\alpha^{K+1} = 1$. If we assume that $\lambda^0 > \lambda(0)$, then we have:

$$\lim_{n \rightarrow \infty} \frac{n}{X^{K+1}(n)} = \lim_{t \rightarrow \infty} \frac{\mathcal{X}^{K+1}(t)}{t} = \lambda(0), \quad P - a.s. \text{ and in } L_1.$$

Proof A weaker version of the result was proved in [2]. The proof of this version is given in [5]. \square

It follows from Theorems 5.2 and 5.3 that

$$1/\lambda^{K+1} = \max(1/\lambda^0, 1/\lambda(0)) = \max_{k=0,1,\dots,K} E \left(\|\sigma_{[0]}^k\| \right).$$

The constant $\lambda(0)$ is the throughput of the network when we saturate the input. The interpretation of Theorem 5.3 is that $\lambda(0)$ is the maximal possible throughput for the network. This follows from the fact that the saturation rule of [3] can be applied. Theorem 5.2 provides a simple practical way to compute the maximal throughput of an open network.

Example 5.4 We consider the network of §3.1. We obtain $\sigma_{[0]}^1 = (1/4, 1/4)$ (two services, each of length 1/4) and $\sigma_{[0]}^2 = (1/2)$. It follows that $\|\sigma_{[0]}^1\| = \|\sigma_{[0]}^2\| = 1/2$. We conclude that the maximal asymptotic throughput of the network is 2.

6 First Order Limits for Different Initial Conditions (B)

We want to obtain extensions of the results of §5 for networks with arbitrary initial conditions. The results will be completely different for open and closed networks. The throughputs do not depend on the initial condition in the open case and they do in the closed case.

6.1 Compatibility

Let ${}_I J = \{(\sigma^k(n), \nu^k(n)), k \in \mathcal{K}, n \in \mathbb{N}\}$ be a Jackson network with an arbitrary finite initial condition $I = \{(Q^k, R^k), k \in \mathcal{K}\}$. We consider a modification ${}_I J_{[\emptyset]}$ of ${}_I J$ obtained by setting $\sigma^*(0) = +\infty$. All other quantities (services, routings and initial condition) are the same in ${}_I J$ and ${}_I J_{[\emptyset]}$. The interpretation is that ${}_I J_{[\emptyset]}$ is obtained by immediately blocking station $*$. Associated quantities are denoted accordingly, for example ${}_I X_{[\emptyset]}$ for the maximal dater.

It follows from Prop. 4.2 that ${}_I X_{[\emptyset]}$ is $P - a.s.$ finite. Furthermore at instant

${}_I X_{[\emptyset]}^+$, the network is empty (open case) or all the customers are in station 1 (closed case).

We define a new network ${}_I \hat{J}$ with service times $\{{}_I \hat{\sigma}^k(n) = \sigma^k(n + {}_I l_{[\emptyset]}^k), n \in \mathbb{N}\}$, $k \in \mathcal{K}$, and routings $\{{}_I \hat{\nu}^k(n) = \nu^k(n + {}_I l_{[\emptyset]}^k), n \in \mathbb{N}\}$, $k \in \mathcal{K}$. The initial condition of ${}_I \hat{J}$ is canonical. The interpretation is that ${}_I \hat{J}$ is the network obtained by unblocking ${}_I J_{[\emptyset]}$ after instant ${}_I X_{[\emptyset]}$.

We are now ready to define *compatibility*. Let ${}_1 J$ and ${}_2 J$ be two Jackson networks differing only by their initial conditions I_1 and I_2 . Let ${}_1 J_{[\emptyset]}$ and ${}_2 J_{[\emptyset]}$ be the blocked networks defined as above. Let ${}_1 \hat{J}$ and ${}_2 \hat{J}$ be the unblocked networks defined as above. Let $\{({}_1 \hat{\sigma}_{[i]}, {}_1 \hat{\nu}_{[i]}), i \geq 0\}$ and $\{({}_2 \hat{\sigma}_{[i]}, {}_2 \hat{\nu}_{[i]}), i \geq 0\}$ be the services and routings used in networks ${}_1 \hat{J}_{[i]}$ and ${}_2 \hat{J}_{[i]}$ respectively.

Definition 6.1 *The initial conditions of ${}_1 J$ and ${}_2 J$ are said to be compatible if*

- (1) $\{({}_1 \hat{\sigma}_{[i]}, {}_1 \hat{\nu}_{[i]}), i \geq 0\}$ *is stationary and ergodic.*
- (2) $\{({}_1 \hat{\sigma}_{[i]}, {}_1 \hat{\nu}_{[i]}), i \geq 0\}$ *has the same distribution as $\{({}_2 \hat{\sigma}_{[i]}, {}_2 \hat{\nu}_{[i]}), i \geq 0\}$.*

Lemma 4.4 provides assumptions under which the first condition is always verified. The next lemma is straightforward.

Lemma 6.2 *Let us consider an i.i.d. Jackson network, see Def. 2.5. Then all initial conditions are compatible.*

Without the i.i.d. assumption, compatibility is not always verified.

Example 6.3 Let us consider the model of §3.3. The networks of Fig. 6.A and 6.B, say ${}_A J$ and ${}_B J$, differ only by their initial condition.

- ${}_A J$. Let us consider the network ${}_A J_{[\emptyset]}$ (as defined above). It gets blocked after the *dark gray* customer has received exactly one service at stations 3 and 4. It implies that the network ${}_A \hat{J}$ has the following sequences of service times:

$$\hat{\sigma}^1(n) = 2, 0, 2, 0, \dots \quad \hat{\sigma}^2(n) = 1, 1, 1, \dots \quad \hat{\sigma}^3(n) = 2, 0, 2, 0, \dots \quad \hat{\sigma}^4(n) = 1, 1, 1, \dots$$

We have $\hat{\nu}_{[i]}^k = k + 1 \pmod{4}$ for all $i \geq 0$ and $\hat{\sigma}_{[i]} = (\hat{\sigma}_{[i]}^1, \dots, \hat{\sigma}_{[i]}^4) = (2, 1, 2, 1)$, i odd, $\hat{\sigma}_{[i]} = (0, 1, 0, 1)$, i even.

- ${}_B J$. The quantities associated with the restricted network ${}_B J_{[i]}$ are $\hat{\nu}_{[i]}^k = k + 1 \pmod{4}$ and $\hat{\sigma}_{[i]} = (2, 1, 0, 1)$, i odd, $\hat{\sigma}_{[i]} = (0, 1, 2, 1)$, i even.

We conclude that the initial conditions of ${}_A J$ and ${}_B J$ are not compatible.

6.2 Closed network

The main theorem is the following one.

Theorem 6.4 *Let ${}_1 J$ and ${}_2 J$ be two closed Jackson networks with finite initial conditions I_1 and I_2 . We assume that I_1 and I_2 are compatible. The networks*

are supposed to verify assumption **H2**. Let ${}_1X^k(n), {}_1\mathcal{X}^k(t)$ and ${}_2X^k(n), {}_2\mathcal{X}^k(t)$ denote the daters and counters associated with ${}_1J$ and ${}_2J$ respectively. There exists a constant λ such that for all $k \in \mathcal{K}$:

$$\begin{aligned} \lim_{n \rightarrow \infty} \frac{n}{{}_1X^k(n)} &= \lim_{t \rightarrow \infty} \frac{{}_1\mathcal{X}^k(t)}{t} = \lim_{n \rightarrow \infty} \frac{n}{{}_2X^k(n)} = \lim_{t \rightarrow \infty} \frac{{}_2\mathcal{X}^k(t)}{t} = \alpha_k \lambda, \quad P - a.s. \\ \lim_{n \rightarrow \infty} E\left(\frac{n}{{}_1X^k(n)}\right) &= \lim_{t \rightarrow \infty} E\left(\frac{{}_1\mathcal{X}^k(t)}{t}\right) = \lim_{n \rightarrow \infty} E\left(\frac{n}{{}_2X^k(n)}\right) = \lim_{t \rightarrow \infty} E\left(\frac{{}_2\mathcal{X}^k(t)}{t}\right) = \alpha_k \lambda, \end{aligned}$$

where α_k is the expected number of visits to station k in ${}_1\hat{J}_{[0]}$ or ${}_2\hat{J}_{[0]}$, see (5.1).

Proof The networks ${}_1\hat{J}$ and ${}_2\hat{J}$ are equivalent in distribution. They also have a canonical initial condition. It implies that we can apply Theorem 5.1. The last step is to prove that the first order limits of ${}_iJ$ and ${}_i\hat{J}$, $i = 1, 2$, are identical. For a more detailed proof, see [5]. \square

For non-compatible initial conditions, the first order limits need not be the same.

Example 6.5 Let us consider the counter-example of §3.3. The throughputs of the networks ${}_AJ$ and ${}_BJ$ are different, equal to $1/3$ and $1/2$ respectively. We know from Example 6.3 that the initial conditions of ${}_AJ$ and ${}_BJ$ are not compatible.

However, we obtain the next Theorem as a corollary of Lemma 4.4 and 6.2

Theorem 6.6 *In an i.i.d. closed Jackson network verifying assumption **H2**, the first order limits $(n/X^k(n), \mathcal{X}^k(t)/t, \dots)$ exist and do not depend on the finite initial condition.*

Remark The results of this section show that first order limits depend only on the distribution of $\{(\sigma_{[p]}, \nu_{[p]}), p \in IN\}$. It implies that the ‘‘unusual’’ stochastic assumption that we make on our Jackson networks (**H1**, see (4.3)) is the ‘‘natural’’ one. It is not an artefact of our method of proof.

6.3 Open network

Let ${}_IJ$ be an open Jackson network with an arbitrary finite initial condition $I = \{(Q^k, R^k), k \in \{1, \dots, K\}\}$.

Let J be the associated network with exactly the same sequences of services and routings but with a canonical initial condition (see Def. 2.3). We assume that J verifies assumptions **H1-2**.

Theorem 6.7 *We assume that $\lambda^0 < \lambda(0)$, see eqn (5.2). For all finite initial conditions I , we have for all $k \in \mathcal{K} \cup \{K+1\}$:*

$$\lim_{n \rightarrow \infty} \frac{n}{{}_IX^k(n)} = \lim_{t \rightarrow \infty} \frac{{}_I\mathcal{X}^k(t)}{t} = \alpha_k \lambda^0, \quad P - a.s. \text{ and in } L_1,$$

where α_k is defined in eqn (2.4). If we assume that $\lambda^0 > \lambda(0)$, then we have:

$$\lim_{n \rightarrow \infty} \frac{n}{{}_IX^{K+1}(n)} = \lim_{t \rightarrow \infty} \frac{{}_I\mathcal{X}^{K+1}(t)}{t} = \lambda(0), \quad P - a.s. \text{ and in } L_1.$$

Proof The first proof was given in [2], for initial conditions which are compatible with the canonical one. The general proof is given in [5]. \square

7 First Order Limits: Concavity of Throughput (C)

7.1 Results and conjecture

The throughput at a station is an increasing function of the vector of initial queue lengths.

Proposition 7.1 *Let ${}_U J$ and ${}_V J$ be two closed Jackson networks differing only in their initial condition. We denote by ${}_U \lambda$ and ${}_V \lambda$ the throughputs at station 1 in ${}_U J$ and ${}_V J$ respectively. Let us assume that ${}_U Q^k \geq {}_V Q^k, k \in \mathcal{K}$. Then we have ${}_U \lambda \geq {}_V \lambda$.*

Proof The result follows from a sample path argument. It was originally proved by Shanthikumar and Yao [28]. \square

As far as concavity is involved, the only result which is known is for exponential networks.

Proposition 7.2 *Let J be an i.i.d. closed Jackson network. We assume furthermore that all the services times are exponentially distributed, i.e. there exist constants $\beta_k, k \in \mathcal{K}$, such that $P\{\sigma^k(0) \geq u\} = \exp(-\beta_k u)$. Let M be the number of customers in the network and $\lambda^k(M)$ be the throughput at station $k, k \in \mathcal{K}$. Then $\lambda^k(M)$ is a concave function of M .*

Proof The proof depends heavily on the product form solution for the stationary distribution of the vector of queue lengths. For details, see Shanthikumar and Yao [27] and also Dowdy and al. [15]. \square

Prop. 7.2 fails to be true for a stationary-ergodic (**H1-2**) Jackson network. Note first that it is now necessary to record the exact initial position of the customers because of the non-uniqueness of the throughput. However, the concavity fails even for an increasing (in the sense of the partial ordering on (Q^1, \dots, Q^K)) sequence of initial conditions. A counter-example is provided in §3.4, see Fig. 10 in particular.

To bridge the gap between this counter-example and Prop. 7.2, the next step would be to (dis)prove the following result.

Conjecture Let J be an i.i.d. closed Jackson network. Then $\lambda^k(M), k \in \mathcal{K}$, is a concave function of M , the number of customers in the network.

8 Second Order Limits (D)

We obtain different types of results for open and closed Jackson networks. In the open case, we prove the existence of minimal stationary regimes for second order processes. In the closed case, there are no general ways of constructing the stationary regime. In both cases, there is no uniqueness of the stationary solutions in general.

8.1 Open network

Let us consider an open network J with a canonical initial condition and satisfying assumptions **H1-2**. The second order processes of J are denoted by $(Q(t), R(t)) = (Q^k(t), R^k(t), k \in \mathcal{K} \setminus 0)$ and $W(t) = (W^k(t), k \in \mathcal{K} \setminus 0)$, see §2.3.

Theorem 8.1 *If $\lambda^0 > \lambda(0)$, then there exists $k \in \mathcal{K}$ such that we have P -a.s.:*

$$Q^k(t) \xrightarrow{t} +\infty, \quad W^k(t) \xrightarrow{t} +\infty.$$

If $\lambda^0 < \lambda(0)$, then the processes $(Q(t), R(t))$ and $W(t), t \geq 0$, converge weakly to a finite and stationary-ergodic limit processes $(Q_\infty(t), R_\infty(t))$ and $W_\infty(t), t \geq 0$.

Proof The proof is given in [2], §6. □

The stationarity of the processes $(Q_\infty(t), R_\infty(t))$ and $W_\infty(t)$ has to be interpreted as a Palm stationarity (i.e. with respect to the instants $\{T_n\}$). These processes are called the minimal stationary regimes for reasons explained in § 9. They are explicitly computed under special assumptions in Section 9. In many cases, there will be multiple stationary regimes depending on the initial condition, see Example 8.2.

Example 8.2 Let us consider the network of §3.1. It was shown in Example 5.4 that $\lambda(0) = 2$. In the example of §3.1, the arrival rate is 1, hence we are in the case $\lambda^0 < \lambda(0)$. However, we have shown that there are several limits for second order processes depending on the initial condition. The minimal stationary regimes are the ones corresponding to $c = 0$. For example, the minimal queue length process is the randomized version of

$$Q_\infty(t) = \begin{cases} (1, 0) & \text{if } t \in [0, 1] \cup_{n>0} [n - 1/4, n + 1/4] \\ (0, 1) & \text{if } t \in \cup_{n>0} [n + 1/4, n + 3/4] \end{cases}$$

Under stronger assumptions, we obtain the following refined result.

Theorem 8.3 *We consider a Jackson network ${}_I J$ with a finite initial condition I . We assume that the sequence of service times $\{(\sigma^k(n), k \in \mathcal{K}), n \in \mathbb{N}\}$ is stationary and ergodic and the sequences of routings $\{\nu^k(n), n \in \mathbb{N}\}, k \in \mathcal{K}$, are i.i.d., mutually independent and independent of the services. Then the results of Theorem 8.1 apply independently of the initial condition. In particular, when $\lambda^0 < \lambda(0)$, there is a unique stationary regime for the second order processes $(Q(t), R(t))$ and $W(t)$. Furthermore, they converge in total variation to their stationary distribution.*

Proof The proof of this result is given in [2], §7. □

Stability region Saying that $[0, \lambda(0)]$ is the *stability region* of an open Jackson network is a way to summarize the results of Theorems 5.2, 6.7 and 8.1. For an input rate $\lambda^0 \in [0, \lambda(0)]$, the output rate (λ^{K+1}) is λ^0 and second order processes are finite. For an input rate $\lambda^0 \notin [0, \lambda(0)]$, the output rate is $\lambda(0)$ and second order processes are asymptotically infinite.

8.2 Closed network

Let J be a closed Jackson network verifying assumptions **H1-2**. In general there is no uniqueness of the stationary regimes for second order processes. This is illustrated by the counter-example of §3.2. Furthermore, we have not been able to obtain a counterpart of Theorem 8.1, i.e. to construct a stationary regime in general. Some insights into the difficulties that arise are given in [6].

Even for i.i.d. closed Jackson networks, no general necessary and sufficient conditions for stability are known. There exist however some good sufficient conditions, see [8, 9], [17], [29] or [20]. The most recent ones are provided in [24].

9 Fluid Open Jackson Networks

The object of this section is to give more detailed results on the class of functions involved in the weak limits for second order variables, like those mentioned in Theorem 8.1. We will concentrate on a rather special model with fluid routing and with deterministic service times, but which still allows one to handle general stationary ergodic external arrival processes. More general cases can be considered along these lines (see [5]).

9.1 Evolution equations for counters

In this section, we consider an open Jackson network J with canonical initial condition, and such that $\sigma^k(n) = \sigma^k = \text{Const.}$ for all $k \neq 0$. We will make use of the following counters:

- $\mathcal{Y}^k(t)$, the total number of services *initiated* in station k in $[0, t]$;
- $\mathcal{A}^k(t)$, the total number of *external* arrivals in station k in $[0, t]$.

In addition, let

$$\Pi_{jk}(p) = \sum_{l=1}^p 1_{\{\nu^j(l)=k\}}, \quad p \in \mathbb{N}, j, k \in \mathcal{K} \setminus 0. \quad (9.1)$$

Using the FIFO hypothesis and the assumption that the network is initially empty, we obtain the following set of recurrence equations, holding for all $t > 0$ and all $k \neq 0$ (see [4] for more details on these equations):

$$\mathcal{Y}^k(t) = (\mathcal{Y}^k(t - \sigma^k) + 1) \wedge \left(\sum_{j=1}^K \Pi_{jk} (\mathcal{Y}^j(t - \sigma^j)) + \mathcal{A}^k(t) \right), \quad (9.2)$$

with initial condition $\mathcal{Y}^k(t) = \mathcal{A}^k(t) = 0$, for $t < 0$.

Fluid networks By definition, the *fluid* network \bar{J} associated with (9.2) is that with evolution equation

$$\bar{\mathcal{Y}}^k(t) = (\bar{\mathcal{Y}}^k(t - \sigma^k) + 1) \wedge \left(\sum_{j=1}^K \mathbb{P}_{jk} \bar{\mathcal{Y}}^j(t - \sigma^j) + \mathcal{A}^k(t) \right), \quad (9.3)$$

where \mathbb{P} is the routing matrix. Such fluid models, which differ completely from the usual fluid models of queuing theory (here only the routing is fluid, whereas the services remain unchanged), were introduced in [12] for a class of Petri nets. Although the state variables stop being integer-valued, we will go on speaking of numbers of customers etc.

When each of the K sequences $\{\nu^k(p)\}$ is stationary, then for all (deterministic) $X \in \mathbb{N}$, $E(\Pi_{jk}(X)) = \mathbb{P}_{jk}E(X)$. Assume that the sequences $\{\nu^k(p)\}$ and the arrival process are independent and that each of the sequences $\{\nu^k(p)\}$ is i.i.d. Then, when X is a random vector of \mathbb{N}^K , the relation $\sum_j \Pi_{jk}(X^j) = \sum_j \mathbb{P}_{jk}E(X^j)$ also holds true whenever X is a stopping time of the sequences $\{\nu^k(p)\}$, $k = 1, \dots, K$. This fact and the concavity of the mappings involved in eqn (9.3) are the key ingredients to prove the following relation between the fluid and the non-fluid equations (see [5] for more details).

Lemma 9.1 *If the sequences $\{\nu^k(p)\}$ and the arrival process are independent and if each of the sequences $\{\nu^k(p)\}$ is i.i.d., then for all $f : \mathbb{R}^K \rightarrow \mathbb{R}$, nondecreasing and concave, and for all $t \in \mathbb{R}^+$, $E(f(\mathcal{Y}(t))) \leq E(f(\bar{\mathcal{Y}}(t)))$.*

We will from now on concentrate on the fluid model.

9.2 Evolution equations for second order variables

When letting t go to infinity in the above evolution equations, we obtain that the total number of events $\bar{\mathcal{Y}}^k = \bar{\mathcal{Y}}^k(\infty)$, $\bar{\mathcal{A}}^k = \bar{\mathcal{A}}^k(\infty)$, satisfy the equation $\bar{\mathcal{Y}} = \bar{\mathcal{Y}}\mathbb{P}^* + \bar{\mathcal{A}}$ where \mathbb{P}^* denotes the restriction of \mathbb{P} to the coordinates $\{1, \dots, K\}$. The total numbers of events do not depend on the values of the service times. This property is a special case of Prop. 4.2 (for fluid).

When $\bar{\mathcal{Y}}$ is finite, let

$$\bar{\mathcal{M}}^k(t) = \bar{\mathcal{Y}}^k - \bar{\mathcal{Y}}^k(t), \quad \bar{\mathcal{B}}^k(t) = \bar{\mathcal{A}}^k - \bar{\mathcal{A}}^k(t), \quad (9.4)$$

be the processes which count the *residual* number of events to take place in station k after time t . These second order variables satisfy the following system of equations:

$$\bar{\mathcal{M}}^k(t) = \left(\bar{\mathcal{M}}^k(t - \sigma^k) - 1 \right) \vee \left(\sum_j \mathbb{P}_{jk} \bar{\mathcal{M}}^j(t - \sigma^j) + \bar{\mathcal{B}}^k(t) \right). \quad (9.5)$$

One can reconstruct the total number $\bar{Q}^k(t)$ of customers present in queue k at time t , from $\bar{\mathcal{M}}^k(\cdot)$ via the formula:

$$\bar{Q}^k(t) = \bar{\mathcal{M}}^k(t) - \sum_j \mathbb{P}_{jk} \bar{\mathcal{M}}^j(t - \sigma^j) - \bar{\mathcal{B}}^k(t). \quad (9.6)$$

Remark Similar evolution equations can be derived for the initial non-fluid network (see [4]), including the case of random services (see the last section therein).

9.3 Stationary regime

In this section, we consider a slotted model where all service times and inter-arrival times are equal to 1. The only randomness comes from the number of external arrivals at time n in station $k = 1 \dots, K$, described by the random sequence $\{\mathcal{A}_{[n]}^k\}$, $n \in \mathbb{Z}$, which is assumed to be such that $\mathcal{A}_{[n]}^k = \mathcal{A}_{[0]}^k \circ \theta^n$, for all k and n . These stochastic assumptions are slightly different from the previous ones in that θ is not necessarily the Palm shift of the arrival process anymore.

Let $M_n^k \equiv \overline{\mathcal{M}}_{[-n,0]}^k(n)$, $n \geq 0$, be the residual process in the system which starts empty at time 0, has arrivals at time $1, 2, \dots, n+1$, with respective numbers of arrivals $\mathcal{A}_{[-n]}$, $\mathcal{A}_{[-n+1]}$, \dots , $\mathcal{A}_{[0]}$. We have $M_0^k = \mathcal{Y}_{[0]}^k$, and from the relation $\overline{\mathcal{M}}_{[-n-1,0]}^k(n+1) \circ \theta = \overline{\mathcal{M}}_{[-n,0]}^k(n+1)$, we obtain that

$$M_{n+1}^k \circ \theta = \overline{\mathcal{Y}}_{[1]}^k + (M_n^k - 1) \vee \left(\sum_j \mathcal{P}_{jk} M_n^j \right). \quad (9.7)$$

It is easy to check that the sequences M_n^k are non-decreasing in n , and that the limit $M = \lim_{n \rightarrow \infty} M_n$ is either a.s. finite or a.s. infinite. When the limit $M = \lim_{n \rightarrow \infty} M_n$ is a.s. finite, it is the minimal solution of the functional equation

$$M^k \circ \theta = \overline{\mathcal{Y}}_{[1]}^k + (M^k - 1) \vee \left(\sum_j \mathcal{P}_{jk} M^j \right). \quad (9.8)$$

These minimal stationary variables allow one to construct an associated “minimal” stationary queuing process (giving the queuing process just before arrival instants), via relation (9.6). More generally, it is in this sense that the limit variables mentioned in Theorem 8.1 are said to be minimal.

Remark In the case where the transpose of matrix \mathcal{P} is substochastic, (9.7) can be rewritten in vector form as $M_{n+1} = \phi(M_n)$, where the random map ϕ is monotone, sub-homogeneous and non-expansive. The existence of the a.s. limit $\max_k M_n^k/n$ follows then immediately from general theorems on such maps given in [6].

Theorem 9.2 below, which is proved using (9.7) and (9.8), gives a representation of the transient and the stationary variables M_n and M .

The following notations will be needed: for $p \leq q$, let

$$a_{[p,q]}^k = \overline{\mathcal{Y}}_{[p,q]}^k - (q - p). \quad (9.9)$$

For $2 \leq h \leq \infty$, let $l^1, l^2(j_1), l^3(j_1, j_2), \dots, l^h(j_1, \dots, j_{h-1})$, be a family of integers indexed by $j = (j_1, \dots, j_{h-1})$ in $\{1, \dots, K\}^{h-1}$. Let $\Delta_n(h)$ denote the set of all families $L = \{l^q(j)\}_{q=1, \dots, h, j \in \{1, \dots, K\}^{h-1}}$ such that for all j , $0 < l^1 < l^2(j) < \dots < l^h(j) \leq n$. Finally, let $\Delta = \Delta_\infty(\infty)$

Theorem 9.2 *Under the foregoing assumptions, the variable M_n^k , $n < \infty$,*

$k = 1, \dots, K$, admits the following representation:

$$M_n^k = \max_{h=0, \dots, n} A_n^k(h), \quad (9.10)$$

with $A_n^k(0) = a_{[-n,0]}^k$, $A_n^k(1) = \max_{0 < l_1 \leq n} a_{[-l_1+1,0]}^k + \sum_j \mathbb{P}_{jk} a_{[-n,-l_1]}^j$, and more generally

$$A_n^k(h) = \max_{L \in \Delta_n(h)} \sum_{\substack{p=0, \dots, h \\ 1 \leq k_1, \dots, k_p \leq K}} a_{[-l^{p+1}(k_1, \dots, k_p)+1, -l^p(k_1, \dots, k_{p-1})]}^{k_p} \prod_{q=1}^p \mathbb{P}_{k_q, k_{q-1}}, \quad (9.11)$$

with the conventions $l^0 = 0$, $l^{h+1} = n+1$, $k_0 = k$ and $\prod_1^0 = 1$.

In the case where the stability condition $E(\mathcal{Y}_{[0]}^k) < 1$, for all k , is satisfied, the stationary variable M^k admits the representation:

$$M^k = \sup_{L \in \Delta} \sum_{\substack{p \geq 0 \\ 1 \leq k_1, k_2, \dots \leq K}} a_{[-l^{p+1}(k_1, \dots, k_p)+1, -l^p(k_1, \dots, k_{p-1})]}^{k_p} \prod_{q=1}^p \mathbb{P}_{k_q, k_{q-1}}. \quad (9.12)$$

Example 9.3 Consider a feedback queue with unit service times, where feedback takes place with probability $p < 1$. Equation (9.7) reads

$$M_{n+1} \circ \theta = \frac{\mathcal{A}_{[1]}}{1-p} + (M_n - 1) \vee (pM_n). \quad (9.13)$$

The solution of this equation is

$$\begin{aligned} M_n &= \frac{1}{1-p} (\mathcal{A}_{[-n,0]} - n) \\ &\vee \max_{0 < l^1 \leq n} \frac{1}{1-p} (\mathcal{A}_{[-l^1+1,0]} - (l^1 - 1)) + \frac{p}{1-p} (\mathcal{A}_{[-n,-l^1]} - (n - l^1)) \vee \dots \\ &\vee \max_{0 < l_1 < \dots < l_q \leq n} \frac{1}{1-p} (\mathcal{A}_{[-l^1+1,0]} - (l^1 - 1)) \\ &\quad + \dots + \frac{p^q}{1-p} (\mathcal{A}_{[-n,-l^q]} - (n - l^q)) \vee \dots \\ &\vee \sum_{q=0}^n \frac{p^q}{1-p} (\mathcal{A}_{[-q]-1}). \end{aligned}$$

The sequence M_n is nondecreasing, and it tends to the limit

$$M = \sup_{0 < l_1 < l_2 < \dots} \sum_{q \geq 0} \frac{p^q}{1-p} \mathcal{A}_{[-l^q+1+1, -l^q]},$$

as n goes to ∞ , which is finite when $E(\mathcal{A}_{[0]}) < 1 - p$.

Bibliography

1. Baccelli, F., Cohen, G., Olsder, G.J., and Quadrat, J.P. *Synchronization and Linearity*. John Wiley & Sons, New York, 1992.
2. Baccelli, F. and Foss, S. Ergodicity of Jackson-type queueing networks. *Queueing Systems*, **17**, 5–72, 1994.
3. Baccelli, F. and Foss, S. On the saturation rule for the stability of queues. *J. Appl. Prob.*, **32(2)**, 494–507, 1995.
4. Baccelli, F., Foss, S. and Gaujal, B. Structural, temporal and stochastic properties of unbounded free-choice Petri nets. INRIA Report **2411**, 1994. To appear in *IEEE Trans. Automatic Control*.
5. Baccelli, F., Foss, S. and Mairesse, J. On the stability of Jackson networks under stationary and ergodic assumptions. In preparation, 1996.
6. Baccelli, F. and Mairesse, J. Ergodic theory of stochastic operators and discrete event networks. In J. Gunawardena, editor, *Idempotency*. Cambridge Univ. Press, 1995.
7. Bambos, N. On closed ring queueing networks. *J. Appl. Prob.*, **29**, 979–995, 1992.
8. Borovkov, A. Limit theorems for queueing networks. I. *Theory Prob. Appl.*, **31**, 413–427, 1986.
9. Borovkov, A. Limit theorems for queueing networks. II. *Theory Prob. Appl.*, **32**, 257–272, 1988.
10. Brandt, A., Franken, P. and Lisek, B. *Stationary Stochastic Models*. Prob. and Math. Stat. Wiley, New York, 1990.
11. Chang, C.S. Stability, queue length and delay of deterministic and stochastic queueing networks. *IEEE Trans. Automatic Control*, **39**, 913–931, 1994.
12. Cohen, G., Gaubert, S. and Quadrat, J.P. Polynomial discrete event systems. In J. Gunawardena, editor, *Idempotency*. Cambridge University Press, 1995.
13. Cohen, J. and Kelly, F. A paradox of congestion in a queueing network. *J. Appl. Prob.*, **27**, 730–734, 1990.
14. Daduna, H. Note on the ergodicity of closed queueing network. Technical Report **88-3**, Hamburg University, 1988.
15. Dowdy, L., Eager, D., Gordon, K. and Saxton, L. Throughput concavity and response time convexity. *Information Processing Letters*, **19**, 209–212, 1984.
16. Foss, S. Some properties of open queueing networks. *Problems of Information Transmission*, **25(3)**, 90–97, 1989.
17. Foss, S. Ergodicity of queueing networks. *Siberian Math. J.*, **32**, 184–203, 1991.
18. Gordon, W. and Newell, G. Closed queueing systems with exponential servers. *Oper. Res.*, **15**, 254–265, 1967.

19. Jackson, J.R. Jobshop-like queueing systems. *Manag. Science*, **10**, 131–142, 1963.
20. Kaspi, H. and Mandelbaum, A. Regenerative closed queueing networks. *Stoch. and Stoch. Reports*, **39**, 239–258, 1992.
21. Kaspi, H. and Mandelbaum, A. On Harris recurrence in continuous time. *Math. Oper. Research (to appear)*, 1994.
22. Mairesse, J. Products of irreducible random matrices in the $(\max, +)$ algebra. Technical Report RR-1939, INRIA, Sophia Antipolis, France, 1993. To appear in *Adv. Applied Prob.*
23. Mairesse, J. *Stabilité des systèmes à événements discrets stochastiques. Approche algébrique*. PhD thesis, Ecole Polytechnique, Paris, 1995. In english.
24. Mairesse, J. New conditions for the stability of closed i.i.d. Jackson networks. In preparation, 1996.
25. Meyn, S. and Down, D. Stability of generalized Jackson networks. *Ann. Appl. Prob.*, **4(1)**, 124–149, 1994.
26. Murata, T. Petri nets: Properties, analysis and applications. *Proceedings of the IEEE*, **77(4)**, 541–580, 1989.
27. Shanthikumar, G. and Yao, D. Second-order properties of the throughput of a closed queueing network. *Math. Oper. Res.*, **13(3)**, 524–534, 1988.
28. Shanthikumar, G. and Yao, D. Stochastic monotonicity in general queueing networks. *J. Appl. Prob.*, **26**, 413–417, 1989.
29. Sigman, K. Notes on the stability of closed queueing networks. *J. Appl. Prob.*, **26**, 678–682, 1989.
30. Sigman, K. The stability of open queueing networks. *Stoch. Proc. and Appl.*, **35**, 11–25, 1990.
31. Willinger, W. Traffic modeling for high-speed networks: theory versus practice. In F. Kelly and R. Williams, editors, *Stochastic Networks*, volume **71** of *IMA*. Springer-Verlag, 1995.