



**HAL**  
open science

# A RECONFIGURABLE ELECTROMAGNETIC BANDGAP STRUCTURE FOR A BEAM STEERING BASE STATION ANTENNA

Halim Boutayeb, T. Brillat, J.P. Daniel, F. Gadot, P.Y. Garel, A. de Lustrac,  
Kouroch Mahdjoubi, P. Ratajczak, Anne-Claude Tarot

► **To cite this version:**

Halim Boutayeb, T. Brillat, J.P. Daniel, F. Gadot, P.Y. Garel, et al.. A RECONFIGURABLE ELECTROMAGNETIC BANDGAP STRUCTURE FOR A BEAM STEERING BASE STATION ANTENNA. Workshop on Innovative Periodic Antennas, Mar 2004, Santiago de Compostela, Spain. pp. 383-389. hal-00164619

**HAL Id: hal-00164619**

**<https://hal.science/hal-00164619>**

Submitted on 22 Jul 2007

**HAL** is a multi-disciplinary open access archive for the deposit and dissemination of scientific research documents, whether they are published or not. The documents may come from teaching and research institutions in France or abroad, or from public or private research centers.

L'archive ouverte pluridisciplinaire **HAL**, est destinée au dépôt et à la diffusion de documents scientifiques de niveau recherche, publiés ou non, émanant des établissements d'enseignement et de recherche français ou étrangers, des laboratoires publics ou privés.

# A RECONFIGURABLE ELECTROMAGNETIC BANDGAP STRUCTURE FOR A BEAM STEERING BASE STATION ANTENNA

H. Boutayeb<sup>(3)</sup>, T. Brillat<sup>(2)</sup>, J.P. Daniel<sup>(5)</sup>, F. Gadot<sup>(1)</sup>, P.Y. Garel<sup>(4)</sup>, A. de Lustrac<sup>(1)</sup>,  
K. Mahdjoubi<sup>(3)</sup>, P. Ratajczak<sup>(4)</sup>, A.C. Tarot<sup>(3)</sup>

<sup>(1)</sup> *IEF, Université Paris XI, UMR 22 du CNRS, Bât. 220  
91415 ORSAY, FRANCE  
andre.delustrac@ief.u-psud.fr, frederique.gadot@ief.u-psud.fr*

<sup>(2)</sup> *GEA, IUT de Ville d'Avray, Université de Paris X  
92410 VILLE D'AVRAY, FRANCE*

<sup>(3)</sup> *IETR, Université de Rennes 1, Bât 11C, Campus de Beaulieu  
35042 RENNES, FRANCE  
halim.boutayeb@univ-rennes1.fr, kouroch.mahdjoubi@univ-rennes1.fr, anne-claude.tarot@univ-rennes1.fr*

<sup>(4)</sup> *France Telecom R&D, Antenna Department, Fort de tete de chien  
06320 LA TURBIE, FRANCE  
philippe.ratajczak@francetelecom.com, pierreyves.garel@francetelecom.com*

<sup>(5)</sup> *ADVANTEN, Germanuim, 80 avenue des Buttes de Coësmes  
35700 RENNES, FRANCE  
jean-pierre.daniel@advanten.fr*

## INTRODUCTION

The purpose of this communication is to present the works of a French Industry and Research sponsored project (RNRT Project) named "BIP" [1]. The goal of this project was to design a beam steering multi-band (GSM/DCS/UMTS) base station antenna. After a presentation of the different partners, we will show how we would solve the problem of the beam steering antenna with a controllable Electromagnetic BandGap (EBG) structure and we will present the results of simulations and experiments in order to validate the concept.

## 1. "BIP" PROJECT PRESENTATION

The RNRT project was started in 2001 with 5 partners:

- 3 french universities laboratories:
  - IEF (Institut d'Electronique Fondamentale), University of PARIS XI
  - GEA (Groupe d'Electronique Appliquée), University of PARIS X,
  - IETR (Institut d'Electronique et de Telecommunication de Rennes), University of RENNES 1,
- Antenna Department of France Telecom R&D,
- Advanten: an antennas & radio applications company.

In this project, we purposed to manage the coverage (single beam or multi-beam) of a base station for mobile communications with a reconfigurable EBG material. The use of this kind of structure for this application must solve different problems like:

- the design of a wide or multi-band controllable EBG material
- the capabilities to control the radiation over 360° in the azimuth plane (the maximum of radiation in the elevation plane stay in the 90° direction),
- the matching of the antenna

## 2. A RECONFIGURABLE EBG MATERIAL

For our application, the EBG structure must have the same electromagnetic behavior for the different frequency bands: GSM, DCS and UMTS.

In order to control the EBG material and to manufacture the structure, we choose a lattice of metallic wires that has a wide Electromagnetic BandGap starting from 0 GHz to a frequency depending on the geometrical parameters of the lattice.

To manage the radiation of the antenna, we choose to control the behavior of the EBG material between to complementary state like a lattice of long metallic wires (fig. 1) without transmission in the frequency range 0 to 20 GHz and a lattice of discontinuous metallic wires with transmission in the same band

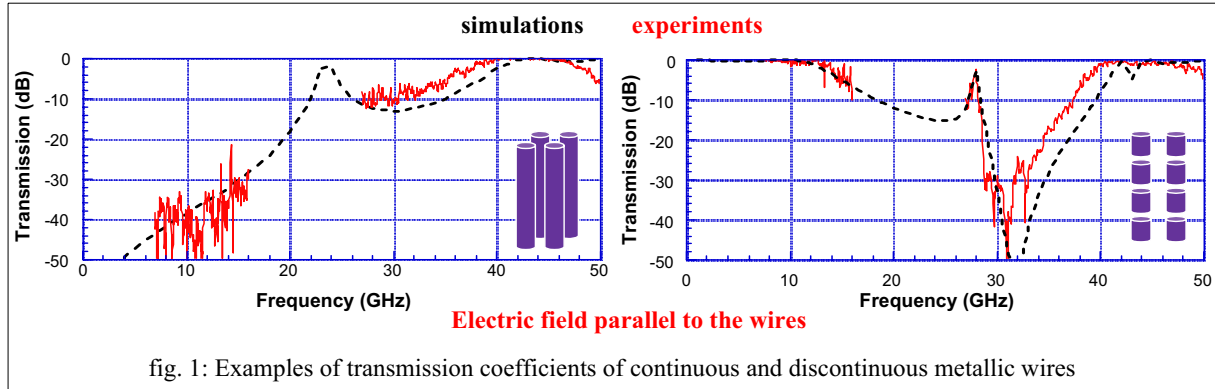

fig. 1: Examples of transmission coefficients of continuous and discontinuous metallic wires

If we inserted diodes between the discontinuous wires [2] we can control the state of the EBG structure as we can see on the figure 2:

- when the diodes are on: the discontinuous impedance and capacitance of the diodes, are
- when the diodes are off: the wires stay discontinuous transparent in the frequency range 0-5 GHz

are equivalent to long wires thanks to the low impedance and capacitance of the diodes, are a reflector in the frequency range 0-15 GHz when the diodes have high impedance and the lattice is

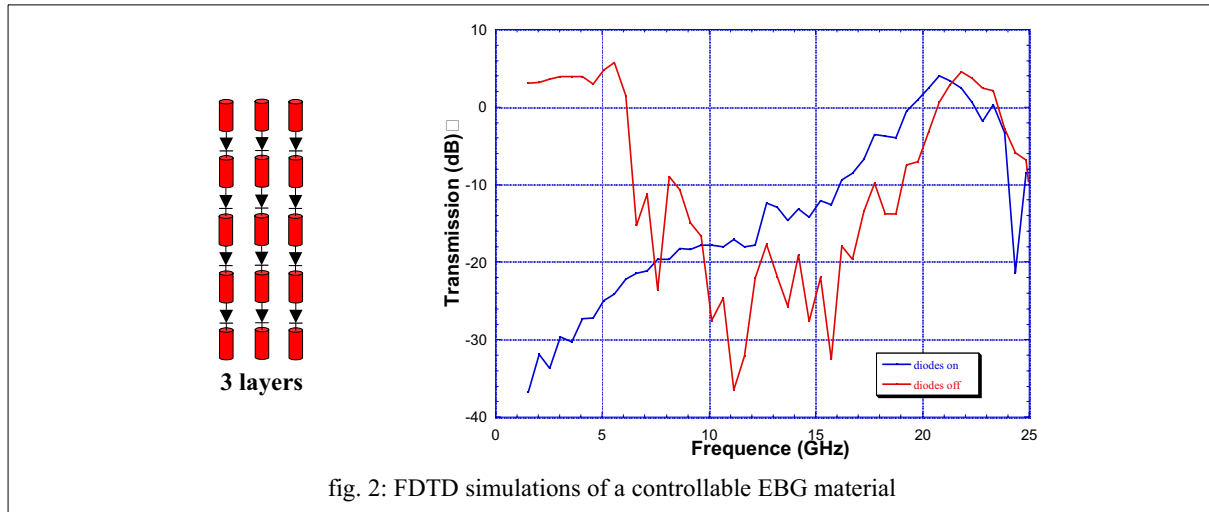

fig. 2: FDTD simulations of a controllable EBG material

The bandwidth of the controllable EBG material is depending on the geometrical parameters of the lattice and the length of the discontinuous part of the wires that must be small toward wavelength. The choice of PIN diodes was made in order to obtain a very low impedance and capacitance when the diodes are on.

### 3. THE BEAM STEERING

The square lattice of the controllable EBG material is transform to a cylindrical one in the center of it we have placed a omni-directional probe [3]. The control of the coverage is made through the bias of the diodes. The figure 3 shows the electric field in different cases of angular sector of diodes off. We can see that:

- when the diodes are on: the angular sectors are like reflectors,
- for the other sectors where the diodes are off, the EBG material is transparent,
- we can choose the azimuth angle, the beamwidth and manage single or multi-beam coverage.

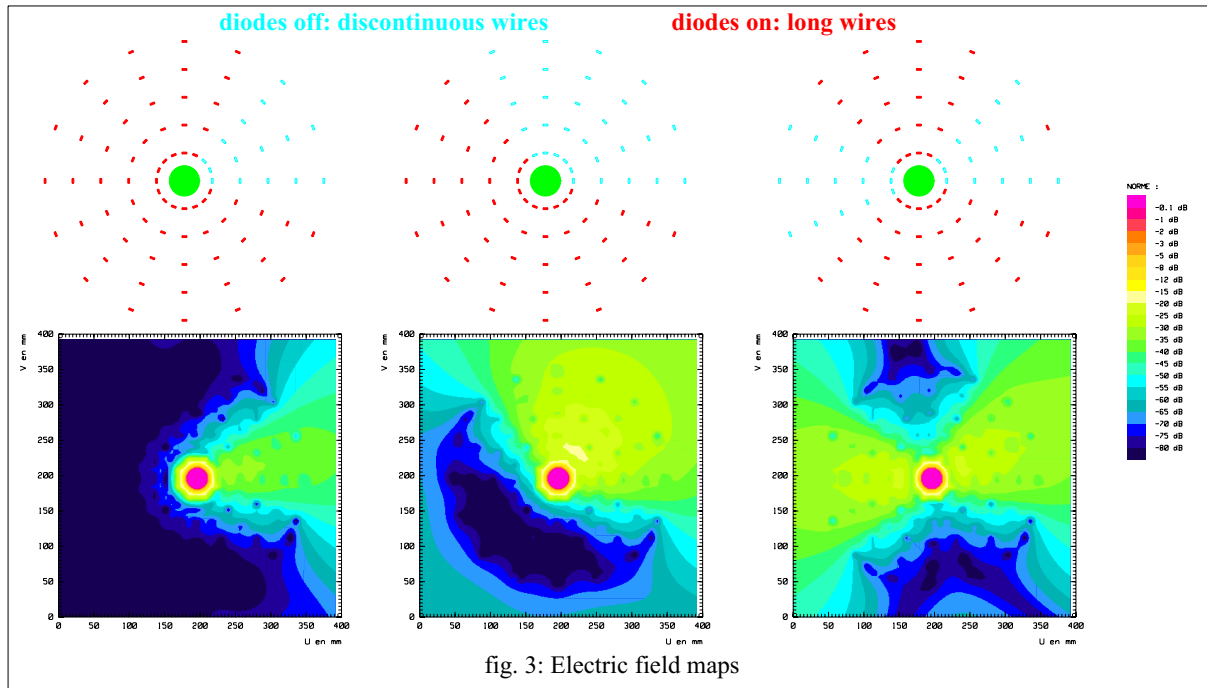

fig. 3: Electric field maps

The matching of this structure: cylindrical EBG material associated to a omni-directional probe in the center is difficult because the reflector behavior of the EBG structure, when the diodes are on, reflects the radiation of the probe. So the radiation go back through the probe and mismatches the input impedance of the antenna.

Different distributions of the cylindrical lattice are possible (fig. 4) like:

- a azimuthally distribution with a constant angle that allows to design a simple control system of the beam steering because a constant number of wire on each cylindrical layer
- a distribution with a constant azimuth step where the beam control system is more complex because each must be controlled independently but allows to match the antenna more easily.

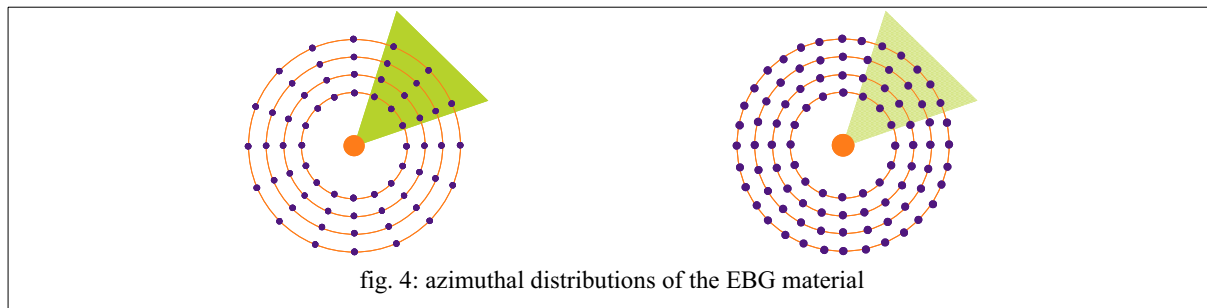

fig. 4: azimuthal distributions of the EBG material

The distribution of the cylindrical lattice has been optimized [3] taking into account that the number of cylindrical layers is fixed by the beam shape, the level of back radiation and the input impedance of the antenna.

#### 4. EVALUATION OF THE PERFORMANCES

In order to estimate the electromagnetic characteristics of the EBG structure to control the coverage of the base station antenna, we develop two breadboards:

- the first one to evaluate the control principle with the EBG material by the design of a single layer of discontinuous metallic wires with diodes
- the second without electronically control but with a four layers of EBG structure of continuous metallic wires to evaluate the EM performances: input impedance, capabilities of the single or multi-beam coverage.

##### 4.1. Performances of the control principle

The breadboard has been realized in Advanten's metallized foam technology.

The probe is a monopole on a ground plane (fig. 5) inserted in a foam cylinder of 100 mm radius and a  $\epsilon_r = 1.2$  with a metallic plate on the top. The discontinuous wires with 6 diodes are placed on the exterior face of the cylinder and spaced by  $15^\circ$ , this number and this spacing have been optimized in order to keep the control and minimize the cost. So there are 144 diodes on this breadboard.

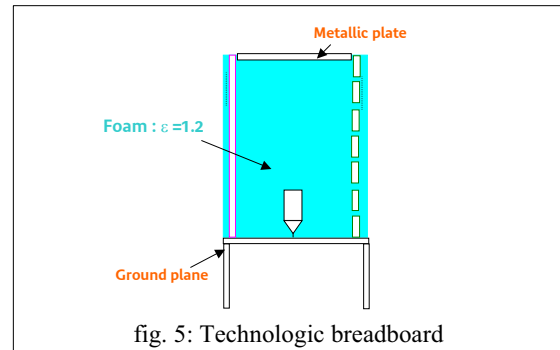

fig. 5: Technologic breadboard

The design of the antenna has been made with a FDTD software and Ansoft HFSS code. A single layer of metallic wires don't allow to match the antenna in the all frequency band (fig. 6) when 6 contiguous wires are open (diodes off) equivalent to a  $90^\circ$  aperture in the EBG structure. The measured reflection coefficient is presented fig. 6. We can see some differences due to feeding kind: lumped feed for the simulations and a waveguide feeding for the experiment.

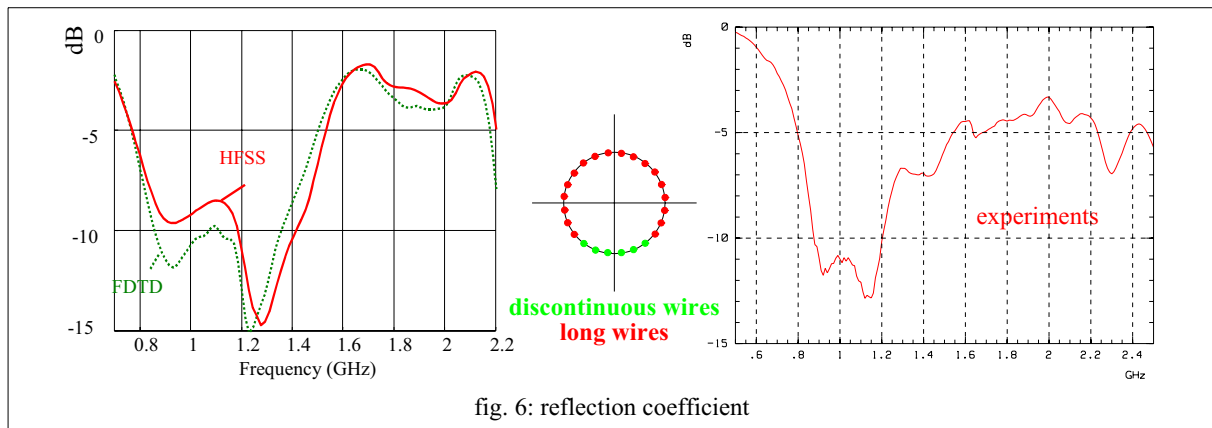

fig. 6: reflection coefficient

The simulated radiation patterns for different frequencies are presented fig. 7. We can see that the maximum of radiation is not in the  $\theta = 90^\circ$  direction because a reduced ground plane.

The radiation patterns at 1.7 GHz are presented fig. 8 for different configurations of the diodes: 6 wires open in the azimuth direction  $+90^\circ$ ,  $-90^\circ$  and  $\pm 90^\circ$ . The radiation patterns in  $E^\theta$  and  $E^\phi$  polarization are plotted in a 2D polar representation where the axis agrees to  $\theta = 0^\circ$  and the exterior circle  $\theta = 180^\circ$ . We can see a small dissymmetry on the back radiation between the  $+90^\circ$  and  $-90^\circ$  configuration certainly due to the manufacturing (soldering, ...).

The experiments show the capabilities of the beam steering with a cylindrical EBG material associated to a omnidirectional probe in the center.

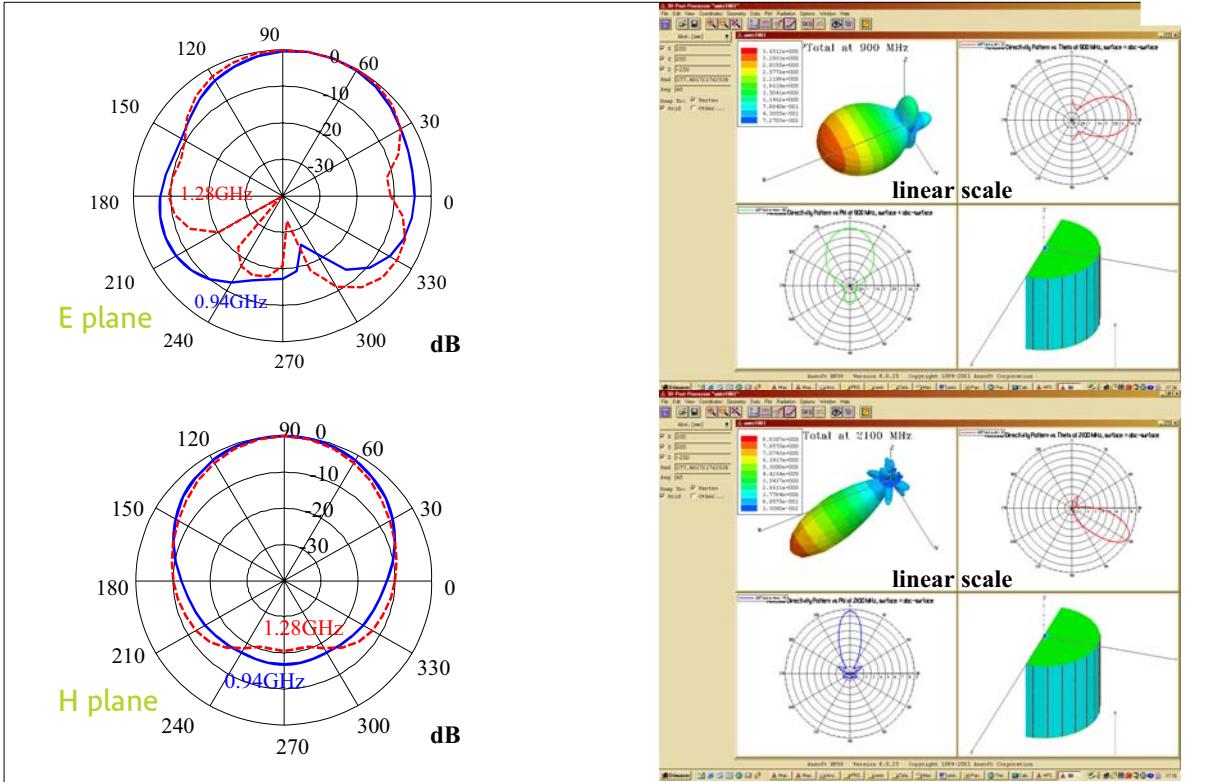

fig. 7: Simulated radiation patterns of the technologic breadboard

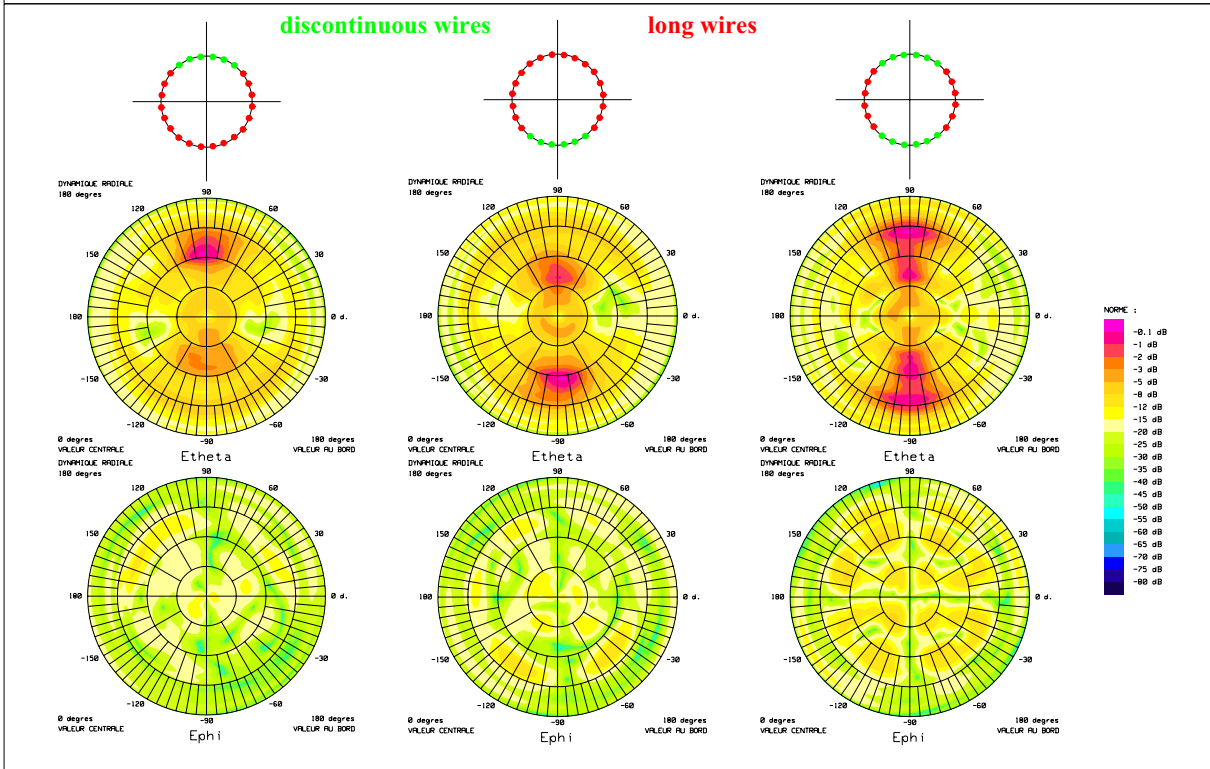

fig. 8: Measured radiation patterns of the technologic breadboard- F = 1.7 GHz

## 4.2. Performances of the beam steering base station

The base station antenna was design with SR3D [4]. The cylindrical EBG material is composed by 4 layers with a constant azimuthally step distribution. For this antenna, we didn't take into account diodes in the EBG material. the structure is modelized with only continuous and discontinuous wires.

On the fig. 9, we can the simulated radiation patterns for different configuration of the EBG material in order to obtain a single or multi-beam coverage. The maximum of radiation in the main polarization ( $E^\theta$ ) is in the  $\theta = 90^\circ$  direction and the level of cross-polarization is below -15 dB for the upper bands and below -10 dB for the GSM band (not presented).

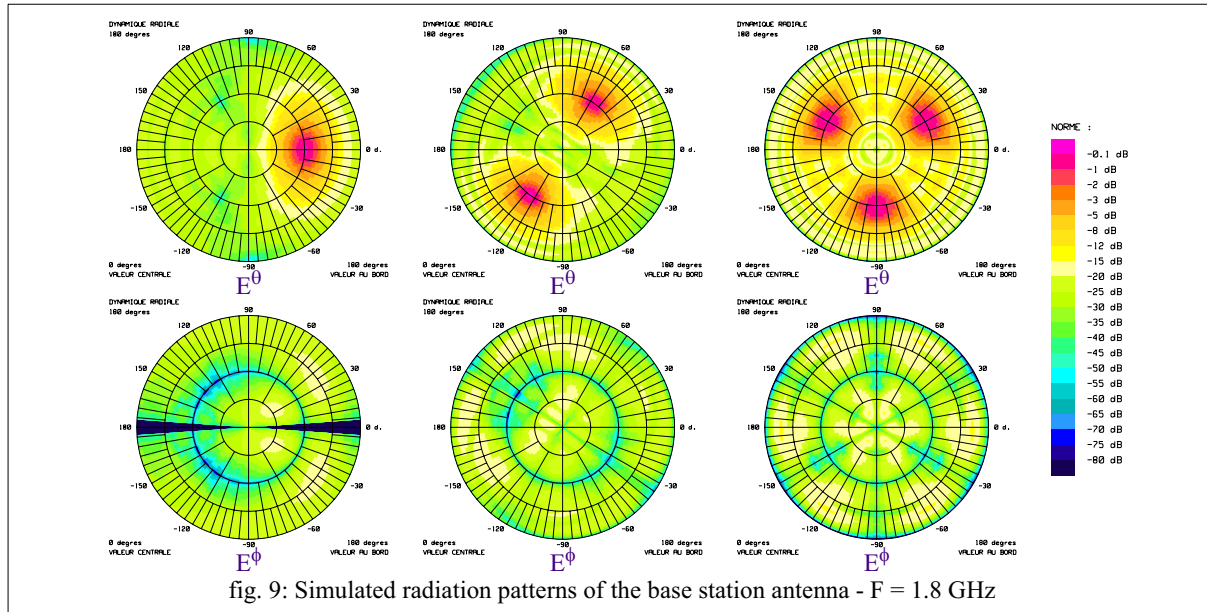

fig. 9: Simulated radiation patterns of the base station antenna -  $F = 1.8$  GHz

For the experiment, we put and remove the long metallic wires depending the configuration of the EBG material, the discontinuous wires didn't have been manufacturing. So in order to compare experiments and simulations, we have realized new simulation in the same geometrical configurations without discontinuous wires.

When the EBG material is open in a aperture of  $60^\circ$ , we can see that the input impedance (fig. 10) is well predicted with SR3D. the simulated S.W.R. (red symbols) is comparable to the measured one (blue line). there is a frequency shift of 20 MHz on the resonance position. A optimization of the input impedance is possible and is shown with the green line.

For the same aperture ( $60^\circ$ ) of the EBG material, the radiation patterns in the  $E^\theta$  polarization are presented fig. 11 at 0.9, 1.75 and 2 GHz. The comparizon between experiment and simulation is excellent. the difference for the 2 GHz pattern is due to the frequency shift.

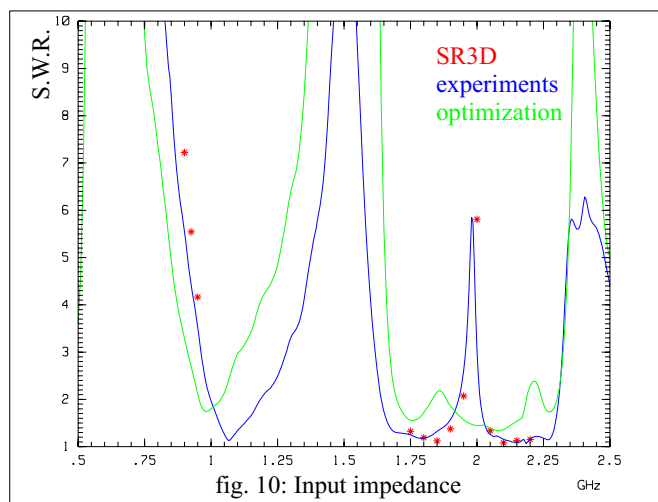
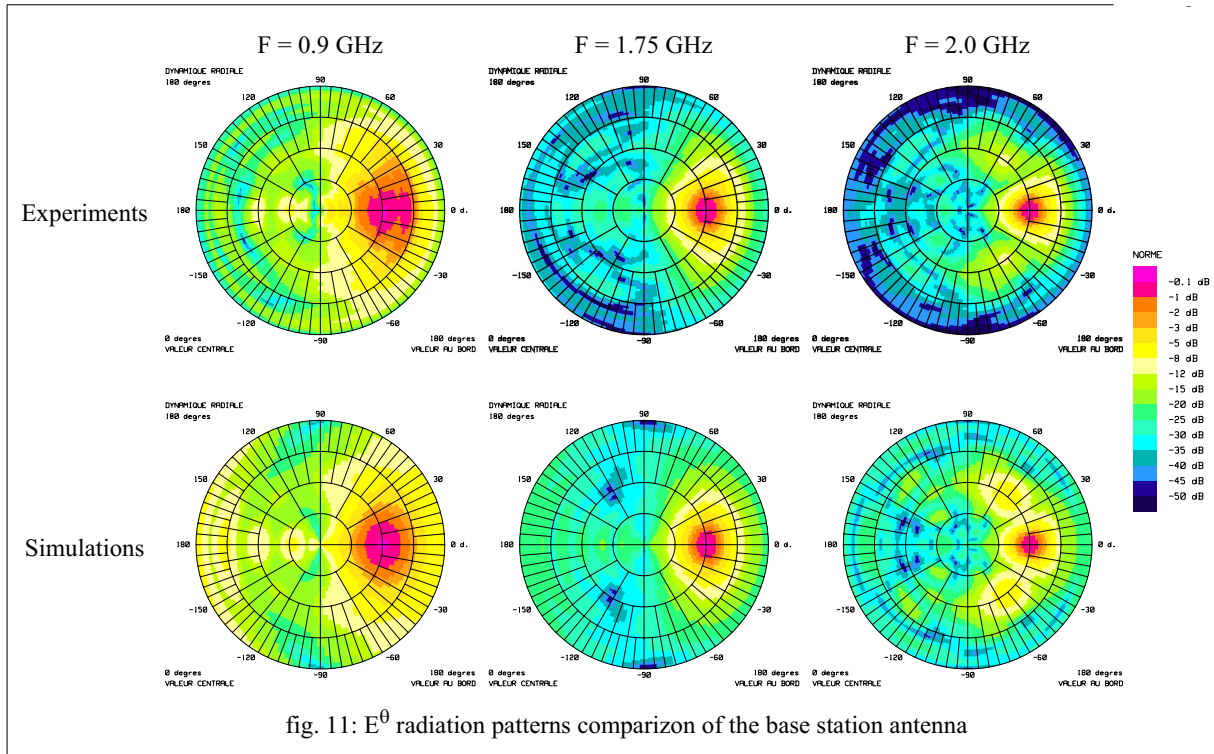

fig. 10: Input impedance



## CONCLUSION

The simulations and experiments show the capabilities of a azimuthally beam steering by a cylindrical EBG material controlled with PIN diodes associated to a omni-directional probe in the center.

The manufacturing of the complete structure with 4 layers of controllable EBG material will allow to validate the concept of this antenna and the use of this technology in term of electromagnetic performances (input impedance, radiation pattern, losses, ...) for the application of base station antenna.

## REFERENCES

- [1] <http://www.telecom.gouv.fr/rnrt>
- [2] A. De Lustrac, T. Brillat, F. Gadot, E. Akmansoy  
"Numerical and experimental demonstration of an electronically controllable PBG in the frequency range 0 to 20 GHz"  
Proceeding AP2000, Davos, April 2000.
- [3] H. Boutayeb  
"Etude des structures périodiques planaires et conformes associées aux antennes. Application aux communications mobiles"  
PhD of Rennes 1 University, December 2003.
- [4] R. Bills, P. Brachat, C. Dedebean, P. Ratajczak,  
"SR3D: Recent Developments for Large EM problems"  
Proceeding JINA 2002, Nice, November 2002.