



HAL
open science

SIL allocation of SIS by aggregation of experts' opinions

Christophe Simon, Mohamed Sallak, Jean-François Aubry

► **To cite this version:**

Christophe Simon, Mohamed Sallak, Jean-François Aubry. SIL allocation of SIS by aggregation of experts' opinions. Safety and Reliability Conference, ESREL'2007, Jun 2007, Stavanger, Norway. pp.753-761. hal-00162477

HAL Id: hal-00162477

<https://hal.science/hal-00162477>

Submitted on 13 Jul 2007

HAL is a multi-disciplinary open access archive for the deposit and dissemination of scientific research documents, whether they are published or not. The documents may come from teaching and research institutions in France or abroad, or from public or private research centers.

L'archive ouverte pluridisciplinaire **HAL**, est destinée au dépôt et à la diffusion de documents scientifiques de niveau recherche, publiés ou non, émanant des établissements d'enseignement et de recherche français ou étrangers, des laboratoires publics ou privés.

SIL allocation of SIS by aggregation of experts' opinions

C. Simon

Research Centre on Automatic Control, CRAN CNRS UMR 7039, 2 Rue Jean Lamour, 54519 Vandoeuvre, France

M. Sallak & J.F. Aubry

Research Centre on Automatic Control, CRAN CNRS UMR 7039, 2 Avenue de la forêt de Haye, 54506 Vandoeuvre, France

ABSTRACT: This paper deals with a process of subjective evaluation to collect imprecise and uncertain experts' opinions with fuzzy numbers as possibility distributions. These opinions are aggregated in the framework of possibility theory. The risk graph logic is translated in a fuzzy inference system in order to compute SIL level. Aggregation of opinions is shown in different cases and the SIL allocation process is applied to an example found in the standard.

1 INTRODUCTION

The current society requirements impose that the industrial facilities present less possible risks during their use. The definition of the risk is found in various standards IEC61508 (IEC 1998), ISO 12100-1 (ISO 2003), ISO 14121 (ISO 1999). It is a combination of the occurrence probability of harm and its gravity. If we wish to reduce the risk, it is during the design step that we have to integrate the elements necessary to the reliability of the installations. Two approaches allow this risk reduction: prevention by minimizing the occurrence probability; protection by limiting the consequences of a malfunction.

To reduce the occurrence probability of the risk, the Safety Instrumented Systems (SIS) are used to fulfil Safety Instrumented Functions (SIF) whose goal is the monitoring of parameters during operation and the implementation of actions to put the system in a safe state when some dangerous operating conditions were encountered. To design these SISs, two standards are used: ANSI/ISA S84.01-1996 (ISA 1996) and the IEC 61508. These two standards are based on the evaluation of the necessary risk reduction to reach an acceptable level of risk. After a preliminary analysis of risks and a quantitative evaluation of the probability of occurrence of the identified risks, we need to evaluate the necessary risk reduction according to a required Safety Integrity Level (SIL). The IEC 61508 frames these steps and proposes the risk graph method or the risk matrix to allocate the level of SIL. This allocation is carried out by experts' opinions based on a combination of descriptive parameters of the risk.

In this paper, we propose a process of subjective evaluation to collect imprecise and uncertain experts' opinions in the particular framework of possibility theory. Possibility distributions are thought to

better reflect imprecision pervading expert judgment. They are weak substitutes to unreachable subjective probabilities (Sandri 1995). The main goal is to manage the imprecision and uncertainty in a SIL allocation process. Section 2 shows some basic elements of SIL allocation process. We discuss about qualitative methods and relations between the different approaches of risk evaluation and the natural subjectivity in expert judgements. In section 3, we show how to collect imprecise and uncertain experts' opinions in the framework of possibility theory with fuzzy numbers and how to adapt the questionnaire accordingly. Some examples are provided to show the behaviour of the adopted principle of aggregation. Section 4 details the fuzzy risk graph obtained by a fuzzy inference system. Section 5 is devoted to an application found in IEC61508.

2 SIL ALLOCATION SCHEME

In this section, we describe the general scheme to achieve the allocation of safety of a system in order to warrant the conformity to the safety standards ANSI/ISA S84.01-1996 (ISA 1996) and IEC 61508 (IEC 1998). Then, we present various qualitative and quantitative methods used for the allocation of SIL. We discuss about the relation between these various methods. The imprecision and uncertainty in experts' opinion is pointed out.

2.1 Safety Instrumented Systems (SIS)

A SIS is a system that aims to put a process in a safe state (*i.e.* a stable state that does not present a risk for the environment or people), when the process involves in a real risk situation (explosion, fire...).

A SIS is composed of three parts:

- A sensor part dedicated to verify the drift of a parameter (pressure, temperature...) towards a dangerous state.
- A logic unit dedicated to collect the signal coming from the sensor, its treatment and to compute the actuator input.
- An actuator part to put the process in a safe state and to maintain it.

The average probability of failure on demand of a SIS is determined by computation of the average probabilities of failure of its components. These probabilities depend on the repair and failure rates of the components, on the factors of common cause ...

2.2 Conformity to standards ANSI/ISA S84.01-1996 and IEC 61508

ANSI/ISA S84.01-1996 and IEC 61508 lay down the requirements related to the specification, the design, the installation, the exploitation and the maintenance of a SIS, in order to have higher confidence in its capacity to bring and/or to maintain the process in a safe state. The basic steps to warrant the conformity to these two safety standards are:

- 1 Establish a target of safety (acceptable risk) of the system and evaluate the existing risk.
- 2 Identify the require safety functions and assign them to the protection levels.
- 3 Determine if the safety instrumented function is required.
- 4 Implement the safety instrumented function in a SIS and determine the SIL of the SIS.
- 5 Check that the SIS reaches the required safety level.

Table 1 gives safety integrity level of a SIS according to the value of its average probability of failure $PF_{D_{avg}}$ and its solicitation frequency.

Solicitation SIL	Low Demand $PF_{D_{avg}}$	High Demand failures/hour
4	$10^{-5} \leq PF_{D_{avg}} \leq 10^{-4}$	$10^{-9} \leq N \leq 10^{-8}$
3	$10^{-4} \leq PF_{D_{avg}} \leq 10^{-3}$	$10^{-8} \leq N \leq 10^{-7}$
2	$10^{-3} \leq PF_{D_{avg}} \leq 10^{-2}$	$10^{-7} \leq N \leq 10^{-6}$
1	$10^{-2} \leq PF_{D_{avg}} \leq 10^{-1}$	$10^{-6} \leq N \leq 10^{-5}$

Table 1: Definition of SIL according to the IEC 61508

2.3 Methods for SIL determination

The determination of the SIL of a SIS can be obtained by various methods:

- 1 Qualitative methods (ISA 1996, Bhimavarapu 1997): they determine the level of SIL starting from the knowledge of the risks associated to the system.

- 2 Semi-quantitative methods (ISA 1996, Bhimavarapu 1997): The most widespread method is the matrix of risk. This matrix gives the level of SIL according to the gravity of the risk and the frequency of occurrence.
- 3 Quantitative methods (Stavrianidis 1998, Bhimavarapu 1997, ISA 2002): They compute the availability of a SIS starting from the failure rate and the repair rate of their components. The most widespread methods are:
 - Simplified equations;
 - Fault Trees;
 - Markovian approaches.

2.4 Risk evaluation

In the majority of risk evaluation methods, we find two attributes: The probability of occurrence and the gravity. They can be evaluated either in a direct manner, i.e. they are the input attributes of the method, or in an indirect manner, i.e. according to other attributes. For example, the probability of occurrence is a function of the probability of occurrence of the dangerous event, of the frequency of exposure of people and the possibility of avoidance. Thus, the risk is defined by two attributes, which can be divided to improve the evaluation of the dangerous situations. It should be noted that certain situations could require a more complex description.

When the evaluation of the descriptive criteria of risk is obtained, the level of risk is determined by methods like risk matrices, risk graphs (IEC 1998) (which can be viewed like a risk matrix), numerical functions (ISSA 1998) and hybrid methods combining several of the previously quoted ones.

Nevertheless, if a risk matrix is suitable to represent a relation between two input attributes and one output attribute, it becomes difficult to introduce more inputs (Figure 1).

A	Frequent	3	2	1	1	1
B	Occasional	3	2	1	1	1
C	Rare	3	2	2	1	1
D	Improbable	3	2	2	2	1
E	nearly impossible	3	3	3	2	2
Occurrence probability Gravity		V	IV	III	II	I
		Toggle injury Without cessation	Toggle injury With cessation	Irreversible injury Minor permanent affection	Irreversible injury Severe permanent affection	death

Figure 1: Example of the risk matrix in SUVA method

The risk graph allows a better representation with a greater number of input attributes (Figure 2).

At last, the numerical functions are useful when the number of attributes or values describing each risk parameter is important. For example, a method quoted in (Pilz 1999) uses the following formula to obtain the risk level:

$$R = NP * LO * FE * DPH \quad (1)$$

With:

- NP : Number of persons exposed,
- LO : Likelihood of occurrence,
- FR : Frequency of exposure to the hazard,
- DPH : Degree of possible harm

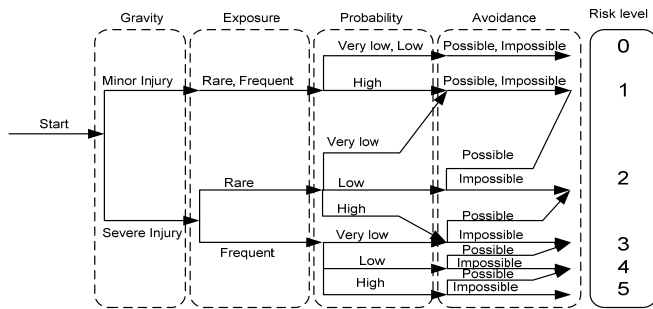

Figure 2: Example of risk graph used by IRSST

As previously mentioned, it is also possible to translate the risk graph (Figure 2) in a corresponding risk matrix (Figure 3).

		Probability 1		Probability 2		Probability 3	
		Avoidance 1	Avoidance 2	Avoidance 1	Avoidance 2	Avoidance 1	Avoidance 2
Gravity 1	Exposure 1	0	0	0	0	1	1
	Exposure 2	0	0	0	0	1	1
Gravity 2	Exposure 1	1	1	1	2	2	3
	Exposure 2	2	3	3	4	4	5

Figure 3: Equivalent risk matrix

The SIL level evaluation of a SIS is based on the risk evaluation. In IEC61508, the risk graph on Figure 4 is proposed. As we can see, this graph is closed to the one on Figure 2

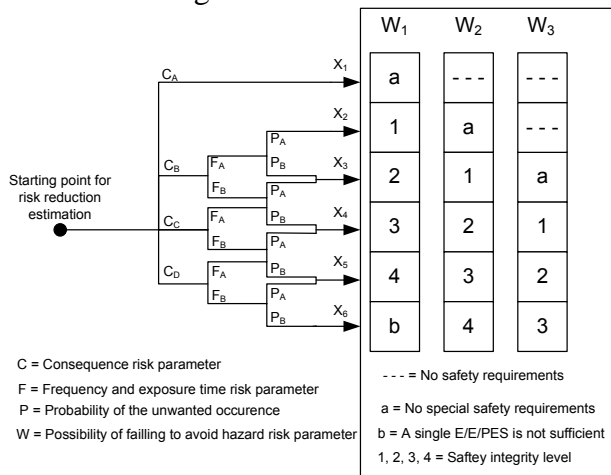

Figure 4: Risk graph in IEC 61508 for SIL allocation

The main difference between the general risk graph (Figure 2) and the IEC61508 risk graph is the output variable that directly characterizes the SIL allocation level for the SIS ($SIL \in \{1,2,3,4\}$). This level corresponds to the necessary risk reduction that the SIS embedding the SIF should reach. Level a indicates that a SIF is not necessary and level b represents the situation where a SIF is not sufficient to ensure the risk reduction.

2.5 The use of experts' opinions

As explained previously, the different risk evaluation methods are based on the same concepts of gravity and occurrence with a more or less fine description of the risk parameters. These descriptions can be qualitative or quantitative. When the feedback is not sufficient, the experts' job is to estimate the quantitative values.

In the case of the graph where the description of the risk is rather accurate and according to the IEC61508, the expert must estimate the values of the 4 parameters to allocate the SIL level. Let us note that the use of the other methods is equivalent as we mentioned in the previous section. These four parameters give a significant granularity of the risk and represent the key factors of the risk evaluation.

In practice, the estimate of the risk parameters by only one expert is not suitable. The possibility to use a great number of experts sounds unrealistic. In addition, the expert opinions about the risk parameters are necessarily imprecise and uncertain since they are subjective (Sandri 1995, Hsu1996, Lee 2002). Then, it is relevant to capture these imperfections to use the most of information from the expert opinions to achieve the SIL level evaluation more certainly and to help searching a consensus between the experts. For this purpose, we propose to use the formal framework of possibility theory and fuzzy set theory that can be found in (Dubois 1997, Sandri 1995, Zadeh 1965, Ayyub 2001). Thus, we adapt the usual steps of risk estimation and the SIL allocation process. Note that other frameworks with different basic axioms like subjective probability (Bedford 2001), Evidence theory (Smets 1992) can be used.

3 COLLECTING THE EXPERTS' OPINIONS

To use imprecise and uncertain experts' opinions, we should realise a relevant collecting process. If we consider the risk graph on Figure 4, each expert must evaluate the four parameters (C, F, P and W). When an ordinal scale is proposed, a loss of dynamics in the opinion is encountered because the expert intuitively connects his evaluation to the consequence. In addition, a single value does not represent a subjective evaluation. The expert often prefers the use of an interval (Sandri 1995). Moreover, a single value does not allow to obtain easily a natural consensus between experts' opinions. With single values for opinion, the consensus is generally obtained with an average or a weighted average, which is not a suitable solution. Intervals help finding a natural consensus between opinions. For these reasons, it is more relevant to change the scales. The goal is to al-

low the experts to express their fuzzy perception of the parameters. Of course, the questionnaires must be well prepared to obtain imprecise and uncertain experts' opinions.

3.1 Rating scale

The usual practice in capturing opinions based on a strict taxonomy is the check box form (Figure 5). In this case, the expert as well as the designer of a questionnaire can encounter several difficulties. If a strict taxonomy is used, the expert can only express his uncertain and imprecise perception by checking two boxes at least. This situation is difficult to handle in the risk graph because it shifts the decision problem directly on the conclusion space (level of SIL). If the expert does not want to use this technique, he should think about the relation between the parameter and the potential decision. This is not a suitable evaluation process. Finally, the questionnaire designer should pay attention to the taxonomy used. It must give a sufficient dynamic and prevents the status quo. The element of the form on Figure 5 is a solution usually suggested (even number of checkboxes for instance 4).

<input type="checkbox"/>	<input type="checkbox"/>	<input type="checkbox"/>	<input type="checkbox"/>
Minor	Low	Medium	High

Figure 5: Usual form

The works on subjective evaluation brings a solution to these problems (Sandri 1995, Zadeh 1965). Rather than evaluating the risk parameters on a digital scale of values, which can involve a distortion particularly at the ends, a continuous axis, calibrated by nouns and bounded by antagonistic qualifiers can be used as shown in Figure 6.

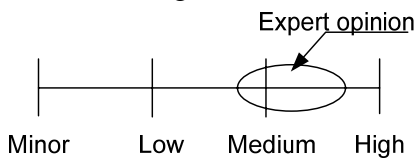

Figure 6: Continuous rating scale

3.2 Subjective evaluation of the risk parameters

In order to allow the experts to express their imprecise perception of the risk graph parameters, we propose the use of a rating scale of each parameter like the one shown on Figure 7. To collect suitable evaluations, we propose the use of trapezoidal fuzzy numbers extensively used in works around fuzzy decision-making based on experts' judgements (Sandri 1995, Hsu 199-, Lee 2002). Each expert gives his imprecise judgement by a possibility distribution defining the degree with which each value of the parameter universe can be the true value. A possibility

distribution can be considered as nested interval. For simplicity, the expert is invited to define two nested intervals. The broadest interval (the support, Figure 7) corresponds to the subset of the axis of evaluation beyond which the expert is certain that the actual value cannot be. The narrowest interval defines the kernel and corresponds to the subset of the evaluation axis on which the expert thinks that the actual value has the strongest possibility to be.

Let us give an evaluation example for the consequence C. The linguistic variables used are given by (see Figure 4):

- Minor: minor harm.
- Low: serious harm affecting one or more persons.
- Medium: Death of several people.
- High: Several killed people.

The same analysis step is carried out on parameters F, P and W.

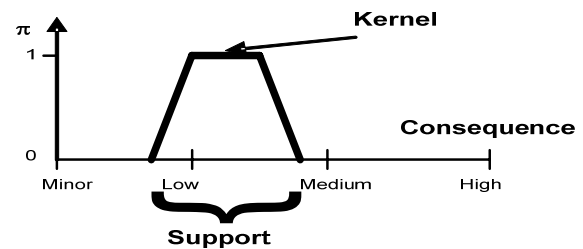

Figure 7: Fuzzy evaluation of the consequence

3.3 Calibration

Each expert evaluates situations according to his perception, experience, and knowledge. The evaluation context may deteriorate its judgment. Thus, it is necessary to calibrate each expert. The calibration process is usual. The goal is to test the expert with perfectly known situations in order to evaluate the relevance of his opinions. In our case, the calibration function must be continuous according to possibility distributions. This benchmark of the expert allows establishing a functional relation ϕ between the imprecise expert's opinions and the risk parameters of the known situations. We obtain calibration functions for each couple expert/parameter, which is used to modify the opinion of the expert in a real situation.

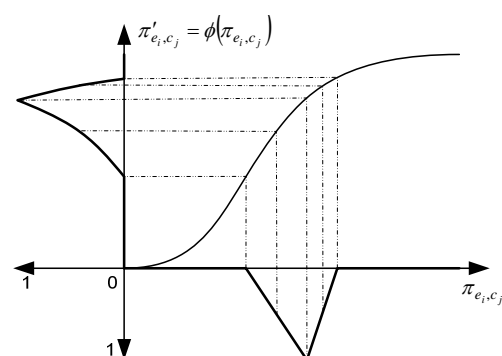

Figure 8: Calibration function

Figure 8 shows a calibration function and it explains how an imprecise opinion of parameter π_{e_i, c_j} can be translated in a corrected opinion π'_{e_i, c_j} .

3.4 Aggregation of the opinions

For each expert e_i , we have a set of opinions given as possibility distributions π_{e_i, c_j} where c_j is the risk parameter $i \in \{C, P, F, W\}$. For each expert, we can take into account his expertise level $w_{ij} \in [0, 1]$ in the evaluation of each parameter c_j .

Within the possibility framework, several aggregation operators are possible (Sandri 1995). The first is the conjunctive operator. It is used when all experts are considered as reliable. It corresponds to the intersection of the opinions. This operator is very sensitive to unmatched opinions. In a perfect world, this situation should not be encountered. When we consider that in a group of experts an unknown one is unreliable, we use the disjunctive operator. It corresponds to the union of the evaluations. This operator can lead to non-informative results (Hsu 1996). Some other operators exist, read (Sandri 1995, Voisin 2001) for more information.

In our example, we try to aggregate opinions by taking account of the experience feedback available from each expert with the four risk parameters. Thus, the aggregation of opinions is carried out for each parameter according to experts' knowledge. The expertise level of an expert modifies the possibility distribution, which represents its opinion π by the following relation:

$$\pi''_{e_i, c_j} = \max(\pi'_{e_i, c_j}, 1 - w_{ij}) \quad (2)$$

Thus, if the expert is certain $w_{ij} = 1$ about his evaluation then its opinion is not modified. When the expert is less certain $0 \leq w_{ij} \leq 1$, a level of uncertainty modifies the evaluation. It corresponds to the possibility that the true value is any value of the reference frame. Finally, if the expert is completely uncertain $w_{ij} = 0$ then we obtain a possibility distribution equal to 1. This distribution represents complete ignorance of the expert due to a lack of confidence.

This expertise level is a priori defined by the expert himself in relation with the application area. However, it is possible to design other adjustment processes, in particular with a supervisor who defines a weight according to the expert credibility (Hsu 1996, Lee 2002).

Finally, the resulting distributions of experts' opinions considered as reliable are aggregated according

to the following conjunctive rule proposed by Sandri (1995):

$$\pi_{c_j} = \min_{e_i}(\pi''_{e_i, c_j}) \quad (3)$$

In the case of disagreement between experts' opinions, (3) cannot be normalized, *i.e.* $\sup \pi_{c_j} < 1$. In this case, we apply the normalization rule in order to keep a possibility distribution:

$$\pi'_{c_j} = \pi_{c_j} + (1 - \sup(\pi_{c_j})) \quad (4)$$

This normalization expresses an uncertainty due to experts' disagreement. The following examples show how the opinions given by two experts on a parameter are aggregated in different cases.

1st case:

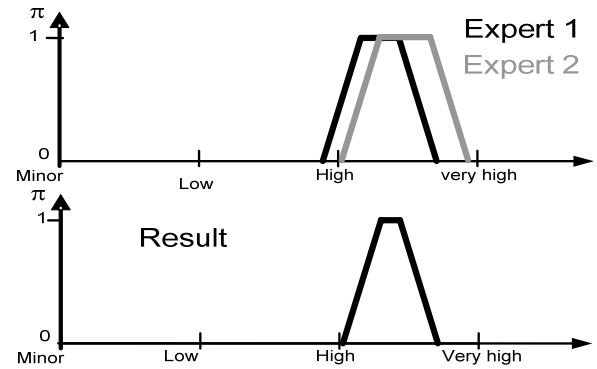

In this example, we considered that the two experts are certain about their opinion. They agree and it is translated by a common intersection between their possibility distributions for the parameter values. The resulting distribution is more precise and concentrates more information (Sandri 1995).

2nd case: the opinion of the first expert has decreased.

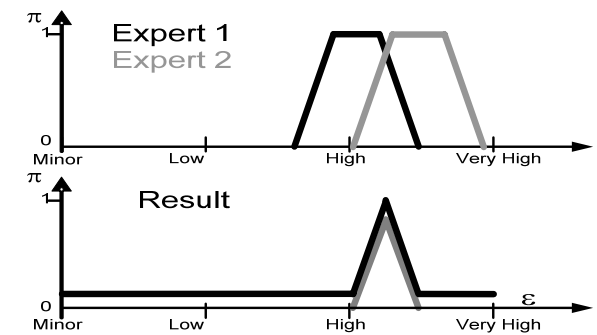

In this example, the two experts do not agree completely. Thus, the kernel of their opinions is lower than the one in the 1st case. In shaded gray line, we see the not normalized aggregation distribution, which shows the opinion conflict. The result in black line after normalization shows uncertainty due to the conflict between the opinions. The resulting kernel is large, the natural agreement between experts is high, and the uncertainty value ε is low.

3rd case: Opinion of expert 1 decreases

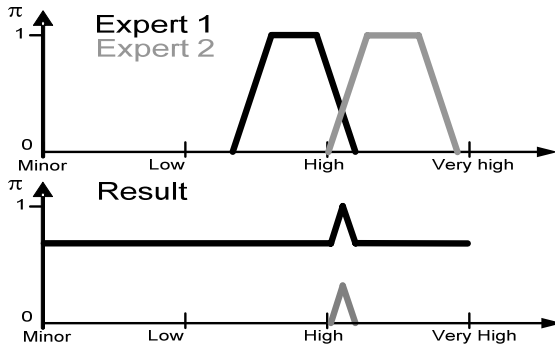

In this example, the disagreement between the experts' opinions is more important. The kernels of the distributions are largely dissociated. There is an important conflict between the experts, which reveals a significant uncertainty in the common opinion about the risk parameter.

Now, let us consider the three previous examples. This time the experts do not have the same level of certainty about their evaluation. First expert is uncertain while the second is a trustful expert.

1st case: expert 1 opinion is in dotted gray line. Black line is the possibility distribution of his opinion taking into account his expertise level (see eq. 2).

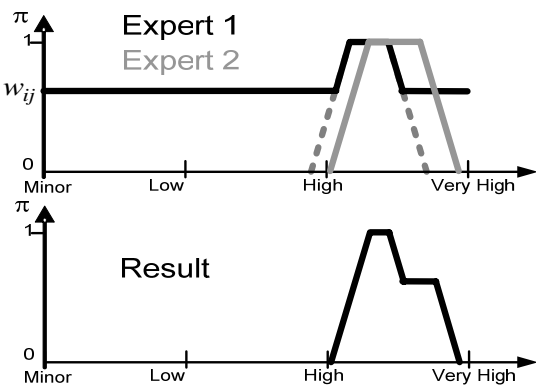

The resulting distribution shows that more information is used from the trustful expert.

In both other cases, we obtain the following results:

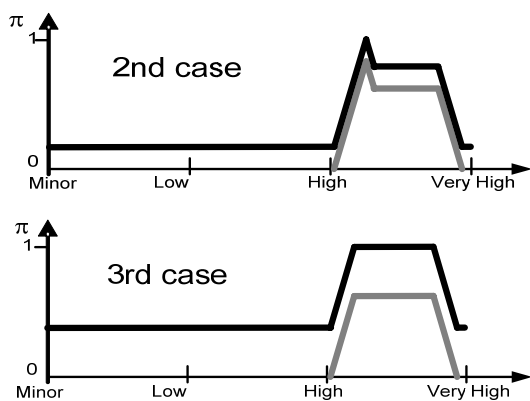

As we can see, the opinion of the trustful expert is preferably used, but when experts completely disagree, the uncertainty grows.

This evaluation technique allows to collect an evaluation of each basic parameter of the risk graph. All evaluations take account the imprecise percep-

tion and the confidence of each expert and their level of expertise as well as the uncertainty related to the disagreement of opinions. Finally, the evaluation of each parameter can be combined according to graph of risk logic or the risk matrix logic.

4 FUZZY RISK GRAPH

The risk graph according to the structure given on Figure 4 does not allow the use of the aggregated experts' opinions as possibility distributions. It is necessary to define a system that reproduces the graph risk logic by taking into account the possibility distributions provided by the experts. A fuzzy inference system offers this possibility and Ormos has proposed a system based on the propositional model of Mamdani (Ormos 2004). This work is based on the same concept.

4.1 Fuzzy partition and fuzzyfication

To use the fuzzy inference system, we must define the fuzzy partitions of each parameters of risk (Figure 4) in the corresponding scales provided to the experts (Bowles 1995). These fuzzy partitions allow the computation of the compatibility between the experts' opinions and the concepts characterized by the linguistic terms of the reference scales (Dubois 1997). Each partition was elaborate based on a statistical analysis of the perception of the values on the reference scales by a sampled population (Figure 9). Each partition respects the constraint $\sum_k \mu_k = 1$. The compatibility of the aggregated opinions with the fuzzy partitions is measured by the min operator in order to determine the value of the premises of the fuzzy inference rules.

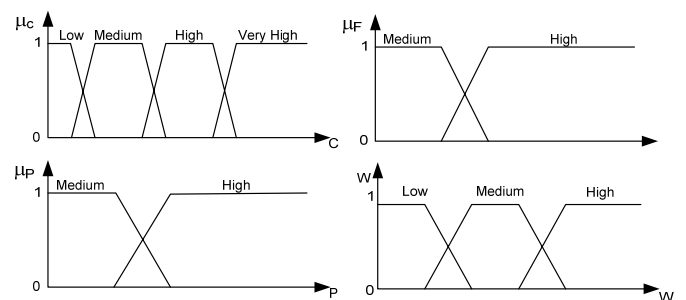

Figure 9: Partitions of evaluation scales.

4.2 Fuzzy inference system

The risk graph logic connects the descriptors of risk parameters (linguistic terms) and those of the conclusion (level of risk or SIL). The fuzzy inference system establishes this relation between inputs fuzzy variables and the output, based on conjunctive (T-norms) and disjunctive operators (T-conorms) (Du-

bois 1996). In the case of binary logic, these operators are clearly defined. In the case of fuzzy logic, the definition of these operators is not unique (Zadeh 1965). In the literature, we find the min/max operators, the product/probabilistic sum ... The min/max operator has the advantage of simplicity during computation, but it exhibits one variable. The product/probabilistic sum operator is more complex to compute but takes the values of the two variables into account. In this work the product/probabilistic sum operator is used.

The fuzzy inference system translating the risk graph suggested by IEC61508 standard (Figure 4) is structured like a set of 'IF THEN' rules as shown on Figure 10.

```

1. If (C is Mineur) and (F is Mineur) and (P is Mineur) and (W is Mineur) then (SIL is SIL1) (1)
2. If (C is Mineur) and (F is Mineur) and (P is Mineur) and (W is Fable) then (SIL is SIL1) (1)
3. If (C is Mineur) and (F is Mineur) and (P is Mineur) and (W is Moyen) then (SIL is SIL1) (1)
4. If (C is Mineur) and (F is Mineur) and (P is Mineur) and (W is Eleve) then (SIL is SIL1) (1)
5. If (C is Mineur) and (F is Mineur) and (P is Tres_faible) and (W is Mineur) then (SIL is SIL1) (1)
6. If (C is Mineur) and (F is Mineur) and (P is Tres_faible) and (W is Fable) then (SIL is SIL1) (1)
7. If (C is Mineur) and (F is Mineur) and (P is Tres_faible) and (W is Moyen) then (SIL is SIL1) (1)
8. If (C is Mineur) and (F is Mineur) and (P is Tres_faible) and (W is Eleve) then (SIL is SIL1) (1)
9. If (C is Mineur) and (F is Mineur) and (P is Fable) and (W is Mineur) then (SIL is SIL1) (1)
10. If (C is Mineur) and (F is Mineur) and (P is Fable) and (W is Fable) then (SIL is SIL1) (1)
11. If (C is Mineur) and (F is Mineur) and (P is Fable) and (W is Moyen) then (SIL is SIL1) (1)
12. If (C is Mineur) and (F is Mineur) and (P is Fable) and (W is Eleve) then (SIL is SIL1) (1)
13. If (C is Mineur) and (F is Mineur) and (P is Moyen) and (W is Mineur) then (SIL is SIL1) (1)

```

Figure 10: Fuzzy inference system

This inference is based on the modus ponens principle, *i.e.* the compatibility evaluation between the aggregate opinions of the experts and the fuzzy partitions of the inputs (premises) gives the firing magnitude of each rule.

4.3 Output fuzzy partition and defuzzification

According to the risk graph and the reference scale of the output, two kind of fuzzy partitions are possible. The SIL levels define an ordinal scale from the set {a, SIL1, SIL2, SIL3, SIL4, b}. Then, the fuzzy partition can be a set of scalar proposition. However, the SIL levels refer to a continuous scale of probability, which corresponds to the risk reduction. In this case, the fuzzy partition corresponds to the intervals of probability as defined in Table 1. In this paper, we prefer the use of a continuous scale to better understand the impact of imprecision and uncertainty of experts' opinions.

A decision can be obtained by the defuzzification operation. Several methods exist (Zadeh 1965), the centre of gravity is privileged in a research of consensus on a continuous scale. The method of the maximum is preferred in the case of an ordinal scale. Collecting imprecise and uncertain experts' opinions must lead to a decision process that takes these imperfections on the conclusion into account. Of course, there is much chance that the proposed risk reduction covers many SIL levels, and cannot be used directly. The goal of the defuzzification step is to give a level of risk reduction translated in SIL.

However, a natural agreement between experts' opinions should be searched by a supervisor during a discussion meeting. The goal is to obtain a change in experts' opinions to obtain just one SIL level with a high confidence (no uncertainty).

5 APPLICATION

Let us consider an example from the standard (ISA 2002). A process composed of a pressurized vessel containing volatile flammable liquid (see Figure 11) can reject material in the environment. The acceptable risk is defined has an average level of gas rejection less than 10^{-4} /year. An HAZOP analysis has shown that the current protection systems (alarm and protection layers) are insufficient to warrant the risk level. Our goal is to determine the SIL level of a safety integrated function that allows to reach the acceptable level of risk. This determination is based on the known risk about the vessel.

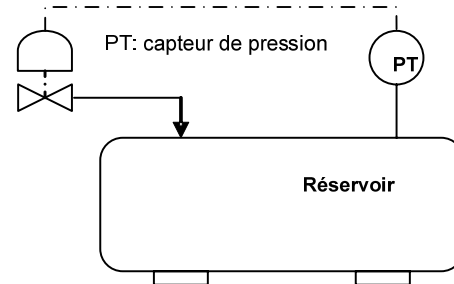

Figure 11: Vessel under pressure

Below are data about the taxonomy of risk parameters used in our work (IEC 1998):

- Significance of the membership functions of the consequence C:
 - Low : minor harm
 - Medium: serious harm affecting one or more persons
 - High: Death of several people
 - Very High: Several killed people
- Significance of the membership functions of the exposure frequency in a dangerous area (F):
 - Medium: exposure from rare to frequent in a dangerous area
 - High: exposure from frequent to permanent in a dangerous zone
- Significance of the membership functions of the possibility to avoid the dangerous events (P):
 - Medium: Possible under some conditions
 - High: Almost impossible
- Significance of the membership functions of the not desired occurrence probability (W):
 - Low: A very weak probability that undesired events occur or only some undesired occurrences is probable

- Medium: A weak probability that undesired events occur or only some undesired occurrences is probable
- High: A high probability that undesired events occur or it is probable that undesired events frequently occur.

According to this glossary, each expert defines for each risk parameter the possibility distribution corresponding to his opinion. The experts' opinions are aggregated according to the method previously defined.

According to the fuzzy inference system described in the previous section, a potential risk reduction (or SIL) level distribution is obtained. The output distribution is defuzzified to obtain a scalar value that represents the risk reduction factor or the SIL level. The main contribution of the suggested aggregation method is to get a risk reduction distribution according to the different risk parameters by taking account imprecision, uncertainty and disagreement in experts' opinions. The SIL level value obtained is only an index satisfying the standard that works with numerical value for the SIL. As mentioned before, it is of better interest to work with the distribution of the risk reduction computed by the fuzzy inference system. The experts' supervisor should use this distribution to manage the discussion meeting. The goal is to help experts defining better opinions in order to obtain only one SIL proposition that corresponds to a confident proposition from imprecise and uncertain opinions.

6 CONCLUSION

In this paper, we have proposed a qualitative method of SIL allocation using a fuzzy risk graph and a system of subjective evaluation to collect imprecise and uncertain experts' opinions. An aggregation process of experts' opinions based on the possibility theory has been proposed. We show the relation between the risk matrix and the risk graph allowing the applicability of the method. One of the interests of this method is the use of a collecting technique of opinions that allows each expert to use his own reference scale where he can express the imprecision and uncertainty of his perception of the risk parameters. This approach has been applied to an example found in the standards. However, it is an open approach, which can be adapted to different application area where new risk parameters can be introduced. This method has the advantage to collect imprecise and uncertain opinions and we can show the effect of these characteristics on the decision. Future works

are now directed to tools for managing the discussion meeting.

REFERENCES

- ISA, ANSI/ISA-S84.01-1996, 1996, Application of Safety Instrumented Systems for the process control industry, Instrumentation Society of America.
- IEC, 1998, IEC 61508: Functional safety of Electrical/ Electronic/Programmable Electronic (E/E/PE) safety related systems, International Electrotechnical Commission (IEC).
- Dubois D. & Prade H., 1997, The three semantics of fuzzy sets, *Fuzzy sets and systems*, 90, 141-150.
- Sandri S.A., Dubois D. & Kalfsbeek, 1995, H., Elicitation, Assessment, and Pooling of Expert Judgements Using Possibility Theory, *IEEE Trans. on Fuzzy Systems*, 3, 313-335.
- Stavrianidis P. & Bhimavarapu K., 1998, Safety Instrumented Functions and Safety Integrity Levels (SIL), *ISA Transactions*, 37, 337-351.
- Bhimavarapu K., Moore L. & Stavrianidis P., 1997, Performance based safety standards: an integrated risk assessment program, *ISA TECH*, 1.
- ISA, ISA-TR84.00.02-2002, 2002, Safety Instrumented Functions (SIF), Safety Integrity Level (SIL), Evaluation Techniques, Instrumentation Society of America.
- Ormos L. & Ajtonyi I., 2004, Soft computing method for determining the safety of technological system by IEC61508, 1st Romanian - Hungarian Joint Symposium on Applied Computational Intelligence.
- Voisin A. & Levrat E., 2001, Evaluation of a sensory measurement fuzzy system for car seat comfort, 10th IEEE International Conference on Fuzzy Systems, Melbourne, Australia, December 2-5.
- ISO, 2003, ISO 12100, Safety of machinery - Basic concepts, general principles for design.
- ISO, 1999, ISO 14121: Safety of machinery - Principles of risk assessment.
- ISSA, International Social Security Association, 1998, *Calculez vous-même vos risques d'accident! Appréciation du risque mécanique au poste de travail*, ISBN 92-843-2130-1 (in French)
- J.B. Bowles & E. Pelàez, 1995, Fuzzy logic prioritization of failures in a system failure mode, effects and criticality analysis, *Reliability Engineering and System Safety*, 50, 203-213.
- L. A. Zadeh, 1965, Fuzzy Sets, *Information and control*, 8, 338-353.
- D. Dubois & Prade H., 1996, What are fuzzy rules and how to use them, *Fuzzy sets and systems*, 84, 169-185.
- Pilz, 1999, Chapter 4: Risk assessment, *Pilz guide to machinery safety*, Pilz automation technology, 6th edition.
- Hsu H.M & Chen C.T., 1996, Aggregation of fuzzy opinions under group decision-making, *Fuzzy Sets and Systems*, 79, 279-285.
- Lee H.S., 2002, Optimal consensus of fuzzy opinions under group decision making environment, *Fuzzy Sets and Systems*, 132, 303-315.
- Ayyub B, 2001, *Elicitation of expert opinions for uncertainty and risks*, CRC press.
- Bedford T. & Cooke R., 2001, *Probabilistic Risk Analysis: Foundations and Methods*, Cambridge University Press.
- Smets Ph., 1992, The Transferable Belief Model for Expert Judgments and Reliability Problems, *Reliability Engineering and System Safety* 38, 59-66.