



HAL
open science

A fault detection and isolation scheme for industrial systems based on multiple operating models

Mickael Rodrigues, Didier Theilliol, Manuel Adam Medina, Dominique Sauter

► **To cite this version:**

Mickael Rodrigues, Didier Theilliol, Manuel Adam Medina, Dominique Sauter. A fault detection and isolation scheme for industrial systems based on multiple operating models. *Control Engineering Practice*, 2008, 16 (2), pp.225-239. 10.1016/j.conengprac.2006.02.020 . hal-00158391

HAL Id: hal-00158391

<https://hal.science/hal-00158391>

Submitted on 2 Mar 2009

HAL is a multi-disciplinary open access archive for the deposit and dissemination of scientific research documents, whether they are published or not. The documents may come from teaching and research institutions in France or abroad, or from public or private research centers.

L'archive ouverte pluridisciplinaire **HAL**, est destinée au dépôt et à la diffusion de documents scientifiques de niveau recherche, publiés ou non, émanant des établissements d'enseignement et de recherche français ou étrangers, des laboratoires publics ou privés.

A Fault Detection and Isolation Scheme for Industrial Systems based on Multiple Operating Models

M. Rodrigues*, D. Theilliol*, M. Adam-Medina[†] and D. Sauter*

** Centre de Recherche en Automatique de Nancy - CNRS UMR 7039*

B.P. 239, 54506, Vandoeuvre Cedex, France.

Phone: +33 383 684 480 - Fax: +33 383 684 462

E-mail: mickael.rodrigues@cran.uhp-nancy.fr

[†] Instituto Tecnológico de la Costa Grande Manzana

30 Lote 1 Col. El limon

CP 40880 Zihuatnejo Gro. Mexico

Abstract

In this paper, a fault diagnosis method is developed for systems described by multi-models. The main contribution consists in the design of a new Fault Detection and Isolation scheme (FDI) through an adaptive filter for such systems. Based on the assumption that dynamic behavior of the process is described by a multi-model approach around different operating points, a set of residual is established in order to generate weighting functions robust to faults. These robust weighting functions are directly linked with the adaptive filter effectiveness which provides multiple fault magnitude estimations for the whole operating range of the system. Stability conditions of the adaptive filter are studied and its performances are tested using an hydraulic system.

Key words: Fault Detection and Isolation, multi-models, decoupling filter, \mathcal{LMI} , stability.

1 Introduction

The role of a human operator is to preserve normal operating conditions according to several plant parameters, measurements and observations. Complex automated industrial systems are vulnerable to faults in instrumentation as sensors, actuators or components. With the growing complexity of modern engineering systems and ever increasing demand for safety and reliability,

there has been great interest in the development of FDI methods. FDI has been developed traditionally with model-based approaches using linear or linearized models (Frank and Ding, 1997; Gertler, 1998; Chen and Patton, 1999) by considering modeling errors or parametric uncertainties. These diagnosis methods are based on residual generation. However, when the system operating range becomes wider, the linearized model is no longer able to represent the dynamic behavior of the system. One solution is to use nonlinear methods such that nonlinear observers with analytical approach (Alcorta-Garcia and Frank, 1997) and geometric approach (Persis and Isidori, 2001) which require a perfect knowledge of nonlinear system.

In practice, process industries as mining, chemical, water treatment processes, are characterized by complex processes which often operate in multiple operating regimes. It is often difficult to obtain nonlinear models that accurately describe plants in all regimes. Also, considerable effort is required for development of nonlinear models. Comparatively, different techniques for linear system identification, control and monitoring are readily available. An attractive alternative to nonlinear technique is to use a multi-linear model strategy.

Multi-linear models methods are based on partitioning the operating range of a system into separate regions and applying local linear models to each region. The multi-model approach has been often used in recent years for modeling and control of nonlinear systems (Murray-Smith and Johansen, 1997). Some methods based on neural networks have been proposed by Narendra et al. (1995). In the philosophy "divide and conquer", Takagi-Sugeno structure based on a fuzzy logic systems has been proposed to model nonlinear systems in fault-free case with multiple linear models. Chen and Patton (1999) have proposed FDI scheme using linear observers and Takagi-Sugeno configuration for nonlinear system representation in the deterministic case. Various studies based on a multi-model approach with a bank of linear Kalman filters have been developed in order to detect, isolate and estimate an accurate state of a system in presence of faults/failures when a model is defined around an operating point (Li and BarShalom, 1993; Maybeck, 1999). In Diao and Passino (2002), a multi-model strategy is developed where each model represents a particular fault in the system. More recently, effectiveness of a multi-model approach on real industrial systems for fault diagnosis (Bhagwat et al., 2003; Gatzke and Doyle, 2002) and for control purposes (Porfirio et al., 2003; Athans et al., 2005) have been demonstrated under the assumptions that weighting functions of models are not affected by faults. On the other hand, a multi-model approach has been developed in faulty case using Polytopic Unknown Inputs Observers (Rodrigues et al., 2005; Rodrigues, 2005) where FDI is performed by taking into account weighting functions coming from the methodology presented in this paper. Weighting functions allow to interpolate models defined around different operating points. However, weighting functions are quite important in a multi-control techniques such as gain scheduling strat-

egy (Leith and Leithead, 2000) or interpolated controllers (Banerjee et al., 1995) or switching controllers (Narendra et al., 1995): these methods do not deal both with multiple operating regimes and faults. Their strategy is totally based on fault-free weighting functions.

Under this consideration, the paper contributes to the fault detection, isolation and estimation in multi-model framework where weighting functions of models are commonly coming from measured data and can be corrupted by faults. The main goal of this paper is to design a scheme which allows simultaneously a FDI and robust weighting functions for systems described by an interpolation of multi-linear models. Moreover, the proposed multi-model method allows to determine both the operating regime and faults at each sample. To achieve this purpose, an adaptive filter is developed based on an interpolated multi-models. The proposed adaptive filter allows an efficient FDI according to a faulty multi-model representation based on decoupled Kalman filter developed by Keller (1999) in linear case.

The paper is organised as follows: in Section 2, the general problem of the weighting functions estimation is developed. A solution based on the design of a bank of decoupled Kalman filters is developed and justified. In Section 3, the design of the adaptive filter is developed in order to estimate multiple faults. The stability study is addressed in terms of Lyapunov quadratic stability by using Linear Matrix Inequality (\mathcal{LMI}). In Section 4, an application to an hydraulic process dedicated to water treatment in mining processing is considered to illustrate the theoretical results. Finally, Section 5 is devoted to conclusions.

2 Robust weighting functions

2.1 System modeling in faulty case

Consider a discrete-time nonlinear dynamical system described by:

$$\begin{cases} X_{k+1} = g(X_k, U_k, d_k) \\ Y_k = h(X_k, U_k, d_k) \end{cases} \quad (1)$$

where $X_k \in \mathcal{X} \subseteq \mathbb{R}^n$ represents the state vector, $U_k \in \mathcal{U} \subseteq \mathbb{R}^p$ is the input vector, $Y_k \in \mathbb{R}^m$ is the output vector and $d_k \in \mathbb{R}^q$ is the fault vector. Functions g and h are assumed to be continuously differentiable in X and U .

Definition: in fault-free case ($d_k = 0$)(Wan and Kothare, 2003)

Given a set \mathcal{U} , a point $X_0 \in \mathcal{X} \subseteq \mathbb{R}^n$ is an equilibrium point of the system (1) if a control $U_0 \subseteq \mathcal{U}$ exists such that $X_0 = g(X_0, U_0)$. We call a connected set of equilibrium points an equilibrium surface. Suppose (X_e, U_e) is a point on an equilibrium surface and define a shifted state $\bar{X} = X - X_e$ and a shifted input $\bar{U} = U - U_e$, the nonlinear system (1) with respect to (X_e, U_e) can be expressed as:

$$\begin{cases} \bar{X}_{k+1} = g(X_k, U_k) - g(X_e, U_e) \triangleq f(\bar{X}_k, \bar{U}_k) \\ \bar{Y}_k = h(X_k, U_k) - h(X_e, U_e) \triangleq v(\bar{X}_k, \bar{U}_k) \end{cases} \quad (2)$$

□

Based on previous definition, it is assumed that the dynamic behaviour of the system at different operating points can be approximated by a set of M Linear Time Invariant (LTI) models as proposed by Murray-Smith and Johansen (1997), Tayebi and Zaremba (2002), Adam-Medina et al. (2003) or Wan and Kothare (2003). Hence, dynamic systems such as nonlinear systems, Linear Time-Varying, linear piecewise systems can be represented by a decomposition of the full operating range into a number of possibly overlapping operating regimes (Leith and Leithead, 2000; Rodrigues, 2005). For each regime, a simple local linear system is defined as Murray-Smith and Johansen (1997). Consequently the state space representation of a system around the j th operating point $\forall j \in [1, \dots, M]$ with additive faults under stochastic assumptions, is described as follows:

$$\begin{cases} X_{k+1} - X_e^j = A_j(X_k - X_e^j) + B_j(U_k - U_e^j) + F_{X_j}d_k + \omega_k^j \\ Y_k - Y_e^j = C_j(X_k - X_e^j) + D_j(U_k - U_e^j) + F_{Y_j}d_k + \nu_k^j \end{cases} \quad (3)$$

Matrices (A_j, B_j, C_j, D_j) are invariant matrices defined around the j th operating point (\mathcal{OP}_j) generally obtained from a first-order Taylor expansion around (X_e^j, U_e^j) or identification of a nonlinear system around predefined operating points (Ozkan et al., 2003; Theilliol et al., 2003). It is assumed that each operating point is well chosen such that state matrices are different from each operating point: it is directly referred to system modeling which is supposed to be correctly done in regards to economical, productivity points of view. Therefore, models for each operating points are assumed to be sufficiently different from each other in order to generate different residuals in FDI scheme. F_{X_j} and F_{Y_j} are distribution matrices of actuator faults and sensor faults respectively. ω^j and ν^j are two independent zero mean white noises with variance-covariance matrices defined respectively by Q^j and R^j . Without loss of generality, D_j is supposed to be equal to zero and according to Park et al. (1994), in the presence of sensor, actuator or component faults, the system represented by the previous state space defined in (3) may be equivalent

to:

$$\begin{cases} X_{k+1} = A_j X_k + B_j U_k + F_j d_k + \Delta_{X_j} + \omega_k^j \\ Y_k = C_j X_k + \Delta_{Y_j} + \nu_k^j \end{cases} \quad (4)$$

with Δ_{X_j} and Δ_{Y_j} are constant vectors depending on the j th linear model such as:

$$\begin{aligned} \Delta_{X_j} &= X_j^e - A_j X_j^e - B_j U_j^e \\ \Delta_{Y_j} &= Y_j^e - C_j X_j^e \end{aligned} \quad (5)$$

The fault distribution matrix is represented by $F_j \in \mathbb{R}^{n \times q}$ $\text{rank}(F_j) = q, \forall j$. Around the j th operating point, it is assumed that $\forall j, \text{rank}(C_j) = m$. This linear system can be specified by the following set of system matrices:

$$S_j = \begin{bmatrix} A_j & B_j & F_j & \Delta_{X_j} \\ C_j & \Delta_{Y_j} & & \end{bmatrix}, \quad \forall j = [1, \dots, M] \quad (6)$$

Let S_k be a matrix sequence varying within a convex set, defined as:

$$S_k := \left\{ \sum_{j=1}^M \varphi_k^j S_j : \varphi_k^j \geq 0, \sum_{j=1}^M \varphi_k^j = 1 \right\} \quad (7)$$

So, S_k characterizes at each sample the system as proposed in fault-free case by Murray-Smith and Johansen (1997), Tayebi and Zaremba (2002) and in faulty-case by Theilliol et al. (2003). Consequently, the system dynamic behavior can be defined by a convex set of multi-LTI models (S_1, S_2, \dots, S_M) . The state space representation (4) under a convex set (7) can be considered as a conventional modeling approach for non linear smooth plant where φ_k^j is an appropriate weighting function. The weighting function φ_k^j embodies the nonlinearity of the plant.

2.2 Problem statement

Now, let consider systems which can be described by a multi-model representation. In the following, we will only use the multi-model representation which is assumed to accurately model the system dynamic behavior. As proposed in Banerjee et al. (1995); Murray-Smith and Johansen (1997), a bank of classical

Kalman filters can be designed to achieve an estimation of φ_k^j . Under assumption that the system evolves around the j th operating point, an i th Kalman filter ($\forall i \in [1, 2, \dots, M]$ which represents the number of Kalman filters) is described by:

$$\begin{cases} \hat{X}_{k+1}^i = A_i \hat{X}_k^i + B_i U_k + K_k^i (Y_k - \hat{Y}_k^i) + \Delta_{X_i} \\ \hat{Y}_k^i = C_i \hat{X}_k^i + \Delta_{Y_i} \end{cases} \quad (8)$$

where $\hat{X}_k^i \in \mathbb{R}^n$ denotes the estimated state vector and $\hat{Y}_k^i \in \mathbb{R}^m$ is the output estimation obtained from the linear filter based on the i th linear model. $K_k^i \in \mathbb{R}^{n \times m}$ is the Kalman filter gain matrix. The index j represents the system and index i is dedicated to the models.

This bank of Kalman filters leads us to obtain the estimated error ε_k^i ($\varepsilon_k^i = X_k - \hat{X}_k^i$) and the output residual vectors r_k^i ($r_k^i = Y_k - \hat{Y}_k^i$). When a fault occurs and operating regime do not change (i.e. when $d \neq 0$ and $j = i$), the difference between the system representation (4) and the filters (8) is represented as follows:

$$\varepsilon_{k+1}^i = (A_i - K_k^i C_i) \varepsilon_k^i + F_j d_k - K_k^i \nu_k^j + \omega_k^j \quad (9)$$

and the output estimation error

$$r_k^i = C_i \varepsilon_k^i + \nu_k^j \quad (10)$$

In the following in fault-free case, the estimation error vector is written as $\bar{\varepsilon}_i$ and the output residual vector is noted \bar{r}_i . In fault-free case, the residual generated by the i th filter is supposed to be a Gaussian distribution with zero-mean value (noted \mathcal{N}). This residual allows to evaluate the validity of each linear model. Indeed, Banerjee et al. (1995) consider the residual vector in order to determine probability of each linear model (validity) by taking into account the previous measurement according to Bayes's probability theory. By definition a valid model is the model that has the greatest probability. The residuals of the filter, considered around the corresponding operating point, follow a Gaussian distribution law. Then, assuming stationarity of residuals, a probability distribution function, noted \wp_k^i , is defined by:

$$\wp_k^i = \frac{\exp\{-0.5 \times r_k^i \times (\Theta_k^i)^{-1} \times (r_k^i)^T\}}{[(2\pi)^m \times \det(\Theta_k^i)]^{1/2}} \quad (11)$$

where $\Theta_i \in \mathbb{R}^m$ is the covariance matrix of the residuals r_k^i . Based on the probability distribution function, a mode probability, noted $\varphi(r_k^i)$, can be computed by the Bayes's theorem $\forall i \in [1, \dots, M]$ as:

$$\varphi(r_{k+1}^i) = \frac{\wp_k^i \times \varphi(r_k^i)}{\sum_{h=1}^M \wp_k^h \times \varphi(r_k^h)} \quad (12)$$

Therefore, the mode probability estimation algorithm can get locked onto one model so that the probability converges to one while the other models converge to zero. This mode probability estimation associated to each model is considered in the following as a weighting function for each model. In the faulty case, the following assessment can be established $\forall i, j \in [1, \dots, M]$:

$$\text{for } j = i, \quad \begin{cases} r_k^i \sim \mathcal{N} \text{ if } d = 0 \\ r_k^i \approx \mathcal{N} \text{ if } d \neq 0 \end{cases} \quad (13)$$

A first assumption has been done previously that each model is different from each one, so only one residual r_k^i can follow a normal gaussian distribution when $j = i$. When $j \neq i$, the difference between the system representation (4) with (A_j, B_j, C_j) and the Kalman filter (8) with (A_i, B_i, C_i) , lead to a residual different from (13), i.e. $r_k^i \approx \mathcal{N}$ for $j \neq i$ whatever d . Otherwise, when $j \neq i$, the difference between the system representation and the Kalman filter leads to:

$$\varepsilon_{k+1}^i = (A_i - K_k^i C_i) \varepsilon_k^i + F_j d_k - K_k^i \nu_k^j + \omega_k^j + (\Delta \Delta_{X_j}^i - K_k^i \Delta \Delta_{Y_j}^i) \xi_{j,k}^i \quad (14)$$

and

$$r_k^i = C_i \varepsilon_k^i + \nu_k^j + \Delta \Delta_{Y_j}^i \xi_{j,k}^i \quad (15)$$

where $\xi_{j,k}^i \in \mathbb{R}^{(n+p+1) \times 1}$ corresponds to the magnitude of the modeling errors between the system represented by the j th linear model and the i th linear model used for the Kalman filters computation. $\Delta \Delta_{X_j}^i \in \mathbb{R}^{n \times (n+p+1)}$ and $\Delta \Delta_{Y_j}^i \in \mathbb{R}^{m \times (n+p+1)}$ are the distribution matrices of modeling error associated to the system state equation and the output equation respectively. Dimensions of $\Delta \Delta_{X_j}^i$ and $\Delta \Delta_{Y_j}^i$ are directly linked with modeling error coming from matrices (A_i, B_i, Δ_{X_i}) and (C_i, D_i, Δ_{Y_i}) respectively.

It should be noted that residual (15) is sensitive to modelling errors (i.e. a change in the operating point or the distance between the model and the filter) and also sensitive to faults. The use of Kalman filters leads to the following residual properties $\forall i, j \in [1, \dots, M]$:

$$\begin{aligned} r_k^i &\sim \mathcal{N}, \text{ if } d = 0, i = j \\ r_k^i &\approx \mathcal{N}, \text{ if } d = 0, i \neq j \\ r_k^i &\approx \mathcal{N}, \text{ if } d \neq 0, \forall i \end{aligned} \tag{16}$$

When $i \neq j$, the algorithm provides weighting functions such that $\forall i \varphi(r_k^i) \neq 1$ but $\sum_{j=1}^M \varphi(r_k^j) = 1$. It underlines the interpolation method between different operating points and the functions $\varphi(r_k^i)$ can take any values between 0 and 1 expressing the validity percentage of a model in regards to the system dynamic behavior (7).

According to (16), FDI cannot be achieved correctly since the residual vector is simultaneously corrupted by operating point changes and fault occurrences. The probabilistic Bayes's method cannot define a suitable weighting function for each model. Moreover, the statistical methods do not allow us to accurately detect and isolate the fault.

A new residual generator is designed allowing faults decoupling in order to provide weighting functions robust to faults. This new residual generator gives a first signal insensitive to faults, but sensitive to modeling errors and a second signal sensitive to faults. The new residual generator is expressed as:

$$\tilde{r}_k^i = \begin{bmatrix} \Sigma_i \\ \Xi_i \end{bmatrix} r_k^i \tag{17}$$

where Σ_i and Ξ_i are terms introduced in order to decouple the residuals with appropriate dimensions and \tilde{r}_k^i is the new residual vector. This consideration lead us to study detection filters generating residuals decoupled from faults as Keller (1999), which we proposed to generalize in the multi-model framework.

2.3 Robust weighting function

Under the assumptions that a fault occurs at time k_d ($k > k_d$) and that operating point change at time k_e ($k > k_e$), the residual vector of the i th filter is expressed as following (Adam-Medina et al., 2003):

$$r_k^i = \bar{r}_k^i + \Delta\Delta_{X_j}^i \xi_{j,k}^i + \rho_{k,k_d} [d_{k_d} \ d_{k_d+1} \ \dots \ d_{k-1}] + \beta_{k,k_e} [\xi_{j,k_e}^i \ \xi_{j,k_e+1}^i \ \dots \ \xi_{j,k-1}^i] \quad (18)$$

with

$$\rho_{k,k_d} = C_i \begin{bmatrix} \Gamma_{k,k_d+1}^i F_j \\ \Gamma_{k,k_d+2}^i F_j \\ \dots \\ F_j \end{bmatrix} \quad (19)$$

and

$$\beta_{k,k_e} = C_i \begin{bmatrix} \Gamma_{k,k_e+1}^i (\Delta\Delta_{X_j}^i - K_{k_e}^i \Delta\Delta_{Y_j}^i) \\ \Gamma_{k,k_e+2}^i (\Delta\Delta_{X_j}^i - K_{k_e+1}^i \Delta\Delta_{Y_j}^i) \\ \dots \\ (\Delta\Delta_{X_j}^i - K_{k-1}^i \Delta\Delta_{Y_j}^i) \end{bmatrix} \quad (20)$$

where

$$\begin{aligned} \Gamma_{k,(k_d,k_e)}^i &= \prod_{\tau=(k_d,k_e)}^{k-1} L_\tau^i \\ L_k^i &= (A_i - K_k^i C_i) \end{aligned} \quad (21)$$

Equation (18) allows us to confirm that residual is affected both by fault and modelling errors. The aim is to generate residuals insensitive to fault but sensitive only to modelling errors, that is:

$$\left(A_i - K_k^i C_i \right) F_i = 0, \quad \forall i \in [1, \dots, M] \quad (22)$$

If equation (22) is satisfied and if the number of faults is strictly lower than the number of outputs (*i.e.* $\text{rank}(C_i F_i) = q < m, \forall i$), a solution to (22) was proposed by Keller (1999) which parametrized a Kalman filter gain as:

$$K_k^i = \omega_i \Xi_i + \bar{K}_k^i \Sigma_i \quad (23)$$

with $\Xi_i = (C_i F_i)^+$, $\omega_i = A_i F_i$, $\Sigma_i = \alpha_i (I_m - C_i F_i \Xi_i)$ and $\alpha_i \in \mathbb{R}^{(m-q) \times m}$ is an arbitrary constant matrix defined so that matrix Σ_i is of full row rank.

Hence, residual defined in (18) under equalities (22) becomes:

$$r_k^i = \bar{r}_k^i + \Delta \Delta_{X_j}^i \xi_{j,k}^i + C_i F_i [d_{k-1}] + \beta_{k,k_e} [\xi_{j,k_e}^i \ \xi_{j,k_e+1}^i \ \cdots \ \xi_{j,k-1}^i] \quad (24)$$

The Kalman filter should also minimize the trace of the variance-covariance matrix of the estimation error. This minimization is carried out under the existence and stability conditions presented and studied in Keller (1999). According to the equation (23), each detection filter, defined in the equation (8), is described by:

$$\begin{cases} \hat{X}_{k+1}^i = A_i \hat{X}_k^i + B_i U_k + (\omega_i \Xi_i + \bar{K}_k^i \Sigma_i) (Y_k - \hat{Y}_k^i) + \Delta_{X_i} \\ \hat{Y}_k^i = C_i \hat{X}_k^i + \Delta_{Y_i} \end{cases} \quad (25)$$

where

$$\bar{K}_k^i = \bar{A}_i \bar{P}_k^i \bar{C}_i^T (\bar{C}_i \bar{P}_k^i \bar{C}_i^T + \bar{V}_i)^{-1} \quad (26)$$

$$\bar{P}_{k+1}^i = (\bar{A}_i - \bar{K}_k^i \bar{C}_i) \bar{P}_k^i (\bar{A}_i - \bar{K}_k^i \bar{C}_i)^T + \bar{K}_k^i \bar{V}_i (\bar{K}_k^i)^T + \bar{Q}_i \quad (27)$$

with $\bar{A}_i = (A_i - \omega_i \Xi_i C_i)$, $\bar{C}_i = \Sigma_i C_i$, $\bar{V}_i = \Sigma_i R_i \Sigma_i^T$ and $\bar{Q}_i = Q_i + \omega_i \Xi_i R_i \Xi_i^T \omega_i^T$.

According to (23) and the previous matrices properties, a residual vector \tilde{r}_k^i can be obtained as suggested in (17):

$$\begin{bmatrix} \Sigma_i (Y_k - \hat{Y}_k^i) \\ \Xi_i (Y_k - \hat{Y}_k^i) \end{bmatrix} = \begin{bmatrix} \Sigma_i r_k^i \\ \Xi_i r_k^i \end{bmatrix} = \begin{bmatrix} \gamma_k^i \\ \Omega_k^i \end{bmatrix} = \tilde{r}_k^i \quad (28)$$

where $\gamma_k^i \in \mathbb{R}^{m-q}$ is the residual vector decoupled from faults and $\Omega_k^i \in \mathbb{R}^q$ is the residual vector sensitive to faults. Due to the matrix properties $\Sigma_i C_i F_j = 0$ and $\Xi_i C_i F_j = I$, each residual (28) can be developed according to equation (18) into insensitive γ_k^i and sensitive Ω_k^i fault vectors respectively expressed as:

$$\gamma_k^i = \Sigma_i (\bar{r}_k^i + \Delta \Delta_{X_j}^i \xi_{j,k}^i) + \Sigma_i \beta_{k,k_e} [\xi_{j,k_e}^i \ \xi_{j,k_e+1}^i \ \cdots \ \xi_{j,k-1}^i] \quad (29)$$

$$\Omega_k^i = d_{k-1} + \Xi_i(\bar{r}_k^i + \Delta\Delta_{X_j}^i \xi_{j,k}^i) + \Xi_i \beta_{k,k_e} [\xi_{j,k_e}^i \xi_{j,k_e+1}^i \cdots \xi_{j,v}^i] \quad (30)$$

Thus, equations (29) and (30) indicate that a bank of decoupling Kalman filters provides a solution to fault distinguishability problem in a multi-model approach. Following these assumptions when the system operates around the j th operating point, the new residual γ_k^i insensitive to fault satisfies to the following properties:

$$\forall d, \quad \begin{cases} \gamma_k^i \sim \mathcal{N} & \text{if } i = j \\ \gamma_k^i \approx \mathcal{N} & \text{if } i \neq j \end{cases} \quad (31)$$

Considering that residual γ_k^i around j th operating point follows a Gaussian distribution, residual vector can then be used to compute the probability distribution as:

$$\wp_k^i = \frac{\exp\{-0.5\gamma_k^i(\Theta_k^i)^{-1}(\gamma_k^i)^T\}}{[(2\pi)^{(m-q)} \det(\Theta_k^i)]^{1/2}} \quad (32)$$

where $\Theta_k^i \in \mathbb{R}^{m-q}$ defines the covariance matrix of the residuals γ_k^i , equal to $(\bar{C}_i \bar{P}_k^i \bar{C}_i^T + \bar{V}_i)$. The probability robust to faults is expressed as:

$$\varphi(\gamma_{k+1}^i) = \frac{\wp_k^i \varphi(\gamma_k^i)}{\sum_{h=1}^M \wp_k^h \varphi(\gamma_k^h)} \quad (33)$$

The probability algorithm allows to obtain a global model describing the system dynamic behavior both in fault-free and faulty cases. The probabilities allows us to determine the operating point where the system is evolving. These probabilities are used to isolate the operating point and consequently define a robust weighting function. Note that when $i \neq j$, it seems that probabilities are not equal to one or zero but can take any value between $[0 \dots 1]$ and $\sum_{i=1}^M \varphi(\gamma_k^i) = 1$. This case underlines the interpolation method when the system is represented by several models defined around multiple operating regimes. The robust weighting function $\varphi(\gamma_k^i)$ is used to represent the plant dynamic behavior as a convex set of multi-linear models such that:

$$S_k^* := \left\{ \sum_{i=1}^M \varphi(\gamma_k^i) S_i : \varphi(\gamma_k^i) \geq 0, \sum_{i=1}^M \varphi(\gamma_k^i) = 1 \right\} \quad (34)$$

where S_k^* represents the global model and S_i is defined as:

$$S_i = \begin{bmatrix} A_i & B_i & F_i & \Delta_{X_i} \\ C_i & \Delta_{Y_i} & & \end{bmatrix}, \quad \forall i = [1, 2, \dots, M] \quad (35)$$

According to (34), the system state space representation is then defined as:

$$\begin{cases} X_{k+1} = A_k^* X_k + B_k^* U_k + F_k^* d_k + \Delta_{X,k}^* \\ Y_k = C_k^* X_k + \Delta_{Y,k}^* \end{cases} \quad (36)$$

where matrices $(\cdot)_k^*$ are equal to $\sum_{i=1}^M \varphi(\gamma_k^i)(\cdot)_i$. Equation (36) represents an estimation of the nominal system without assumptions on state and measurement noises. This convex set representation is used to design an adaptive filter which is developed in the following section for fault detection, isolation and estimation.

3 Design of an Adaptive Filter

3.1 System modeling

To design the adaptive filter, an unique formulation of the convex representation is proposed. In the state space representation (36), a matrix F_k^* is calculated as: $F_k^* = \sum_{i=1}^M \varphi(\gamma_k^i) F_i$ where matrix $F_i \in \mathbb{R}^{n \times q}$ is the fault distribution matrix for each model i . Faults effects are described into state space representation by: $\left(\sum_{i=1}^M \varphi(\gamma_k^i) F_i \right) d_k$.

Definition 1 Matrix F_i^h (respectively \mathfrak{S}^h) defines the h th column of matrix F_i (respectively \mathfrak{S}).

Proposition 1 $\forall h \in [1 \dots q], \forall i \in [1 \dots M]$, with $\text{rank}[F_i] = q$ if $\text{rank}[F_1^h \dots F_i^h \dots F_M^h] = 1$, then

$$\left(\sum_{i=1}^M \varphi(\gamma_k^i) F_i \right) d_k = \mathfrak{S} f_k$$

where $d \in \mathbb{R}^q$ represents the actual fault vector, $f \in \mathbb{R}^q$ is an image of fault vector and $\mathfrak{S} \in \mathbb{R}^{n \times q}$ is a constant fault distribution matrix which column vectors get direction of column vectors of matrices F_i . ■

Proof: See Appendix B. □

The actual fault vector can be estimated as follows:

$$d_k = \left(\sum_{i=1}^M \varphi(\gamma_k^i) F_i \right)^+ \mathfrak{S} f_k \quad (37)$$

where $(\cdot)^+$ denotes the Moore-Penrose matrix. Based on *Proposition 1*, the system (36) is rewritten as:

$$\begin{cases} X_{k+1} = A_k^* X_k + B_k^* U_k + \mathfrak{S} f_k + \Delta_{X,k}^* \\ Y_k = C_k^* X_k + \Delta_{Y,k}^* \end{cases} \quad (38)$$

where \mathfrak{S} is the new faulty distribution matrix representation. In the following, it is assumed that there is no nonlinearity on the outputs and moreover matrices C_i are equal to an unique matrix C .

3.2 Adaptive Filter Design

In order to detect and isolate faults, a classical discrete filter with a gain K_k could be designed according to matrices A_k^* and C defined in (36):

$$\begin{cases} \hat{X}_{k+1} = A_k^* \hat{X}_k + B_k^* U_k + K_k (Y_k - \hat{Y}_k) + \Delta_{X,k}^* \\ \hat{Y}_k = C \hat{X}_k + \Delta_{Y,k}^* \end{cases} \quad (39)$$

where \hat{X} and \hat{Y} represent the estimated state and the estimated output respectively. According to (39) estimation error e_k ($e_k = X_k - \hat{X}_k$) and output residual r_k ($r_k = Y_k - \hat{Y}_k$) are expressed as:

$$\begin{cases} e_{k+1} = (A_k^* - K_k C) e_k + \mathfrak{S} f_k \\ r_k = C e_k \end{cases} \quad (40)$$

Under the assumption that a fault occurs at time k_d ($k > k_d$), residual vector is defined as:

$$r_k = \bar{r}_k + \rho_{k,k_d} [f_{k_d} \ f_{k_d+1} \ \cdots \ f_{k-1}] \quad (41)$$

where \bar{r}_k represents the residual in fault-free case and

$$\rho_{k,k_d} = C \begin{bmatrix} \Gamma_k^{k_d+1} \mathfrak{S} \\ \Gamma_k^{k_d+2} \mathfrak{S} \\ \dots \\ \mathfrak{S} \end{bmatrix} \quad (42)$$

with $\Gamma_k^{k_d} = \prod_{\tau=k_d}^{k-1} L_\tau$, $L_k = (A_k^* - K_k C)$.

As defined in the previous section, gain K_k is design such that $((A_k^* - K_k C)\mathfrak{S})$ is equal to zero. Under the general classical condition that the number of faults is not greater than the number of measurements (*i.e.* $rank(C\mathfrak{S}) < m$), an adaptive filter insensitive to faults is designed with the following gain:

$$K_k = \omega_k \Pi + \bar{K}_k \Sigma \quad (43)$$

with $\Pi = (C\mathfrak{S})^+$, $\omega_k = A_k^* \mathfrak{S}$ and $\Sigma = \alpha(I_m - C\mathfrak{S}\Pi)$ where α is an arbitrary matrix determined so that matrix Σ is full row rank. According to (43), the decoupling filter is defined as:

$$\begin{cases} \tilde{X}_{k+1} = A_k^* \tilde{X}_k + B_k^* U_k + \Delta_{\tilde{X},k}^* + (\omega_k \Pi + \bar{K}_k \Sigma)(Y_k - \tilde{Y}_k) \\ \tilde{Y}_k = C \tilde{X}_k + \Delta_{\tilde{Y},k}^* \end{cases} \quad (44)$$

where \tilde{X}_k and \tilde{Y}_k are respectively the estimated state and the estimated output. The gain decomposition (43) involves the following matrices properties:

$$\Pi C \mathfrak{S} = I \text{ and } \Sigma C \mathfrak{S} = 0 \quad (45)$$

and makes possible the generation of a new residual vector:

$$\begin{bmatrix} \gamma_k^* \\ \Omega_k^* \end{bmatrix} = \begin{bmatrix} \Sigma \\ \Pi \end{bmatrix} r_k = \begin{bmatrix} \Sigma \bar{r}_k \\ \Pi \bar{r}_k + f_{k-1} \end{bmatrix} \quad (46)$$

It should be noticed that $\gamma_k^* \in \mathbb{R}^{m-q}$ is a residual vector insensitive to faults and $\Omega_k^* \in \mathbb{R}^q$ is a residual vector sensitive to faults and defines also a fault estimation of f_k . With only one sample for time delay and as previously mentioned in Proposition 1, an estimation \hat{d}_k of d_k could be realized through a Moore-Penrose matrix as $\hat{d}_k = \left(\sum_{i=1}^M \varphi(\gamma_k^i) F_i \right)^+ \mathfrak{S} \Omega_k^*$.

The gain \bar{K}_k (43) is the unique degree of freedom in the adaptive filter synthesis. It is designed such as an interpolation of gains \bar{K}_i designed for each model, see Stiwell and Rugh (1999); Leith and Leithead (2000). In the following, \bar{K}_k is noted $\bar{K}_k^* = \sum_{i=1}^M \varphi(\gamma_k^i) \bar{K}_i$.

In fault-free case, according to gain K_k definition (43) and previous definitions of filter matrices, the estimation error e_k (40) (noted \bar{e}_k in fault-free case) can be rewritten as:

$$\begin{aligned}\bar{e}_{k+1} &= (A_k^* - K_k C) \bar{e}_k = (A_k^* - (\omega_k \Pi + \bar{K}_k^* \Sigma) C) \bar{e}_k \\ &= (A_k^* (I - \mathfrak{S} \Pi C) - \bar{K}_k^* \Sigma C) \bar{e}_k \\ &= (\bar{A}_k^* - \bar{K}_k^* \bar{C}) \bar{e}_k\end{aligned}\quad (47)$$

with $\bar{A}_k^* = \sum_{i=1}^N \varphi(\gamma_k^i) \bar{A}_i$ and $\bar{A}_i = A_i (I - \mathfrak{S} \Pi C)$.

3.3 Stability

Using Lyapunov stability definition, the gains \bar{K}_i can be established off-line by resolving the following inequalities:

$$\begin{aligned}(\bar{A}_i - \bar{K}_i \bar{C})^T P (\bar{A}_i - \bar{K}_i \bar{C}) - P &< 0 \\ P &> 0, \quad \forall i \in [1, \dots, M]\end{aligned}\quad (48)$$

Schur Complement (Boyd et al., 1994) transforms inequality (48) in the following way:

$$\begin{pmatrix} P & (\bar{A}_i - \bar{K}_i \bar{C})^T P \\ P(\bar{A}_i - \bar{K}_i \bar{C}) & P \end{pmatrix} > 0, \quad \forall i \in [1, \dots, M]\quad (49)$$

So, last inequality is not linear in variables P and \bar{K}_i . By using a change of variables, it is possible to linearize the previous inequality with $P \bar{K}_i = R_i$:

$$\begin{pmatrix} P & \bar{A}_i^T P - \bar{C}^T R_i^T \\ P \bar{A}_i - R_i \bar{C} & P \end{pmatrix} > 0, \quad \forall i \in [1, \dots, M]\quad (50)$$

If the previous inequalities (50) hold true $\forall i \in [1, \dots, M]$, then gains $\bar{K}_i = P^{-1}R_i$ ensure the quadratic stability of the filter estimation error (47). Indeed, by multiplying each \mathcal{LMI} (50) by $\varphi(\gamma_k^i)$ such that $\varphi(\gamma_k^i) \geq 0$, $\sum_{i=1}^M \varphi(\gamma_k^i) = 1$ and by summing all of them, we obtain:

$$\begin{pmatrix} P & \sum_{i=1}^M \varphi(\gamma_k^i)(\bar{A}_i^T P - \bar{C}^T R_i^T) \\ \sum_{i=1}^M \varphi(\gamma_k^i)(P \bar{A}_i - R_i \bar{C}) & P \end{pmatrix} > 0 \quad (51)$$

By resolving inequality (51), matrices $(\bar{A}_i - \bar{K}_i \bar{C})$ are said quadratically stable (Rodrigues et al., 2005) with $\bar{K}_i = P^{-1}R_i, \forall i \in [1, \dots, M]$. So, find a matrix $P > 0, \forall i = [1, \dots, M]$ allow to guarantee the filter quadratic stability (44).

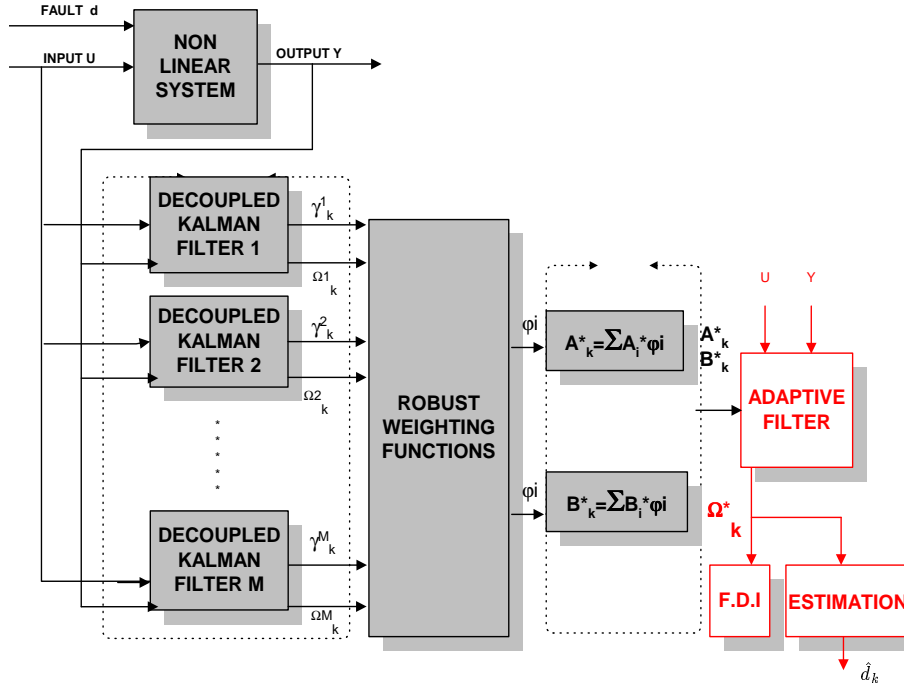

Fig. 1. General FDI scheme

The general concept of FDI in multi-model framework is summarized in figure (1). The robust weighting function generation is obtained from decoupled Kalman filters synthesized on each model established around each operating regime. The fault detection, isolation and estimation scheme is coming from the adaptive filter based on available weighting functions robust to faults.

4 Application to an hydraulic system

The proposed FDI scheme is applied to an hydraulic system (Zolghadri et al., 1996; Theilliol et al., 2002) as shown in figure (2). This process can be dedicated to treatment (water, products,...) where chemical reactions are supposed to occur around predefined operating points. These reactions are supposed to operate under some specific levels of chemical products for providing an optimal product concentration. For this purpose, the example underlines the importance of liquid levels control in a plant so as to provide specific products. In our study for simplicity, mixing actuators are not considered and not represented in figure (2).

The hydraulic system is composed of three cylindrical tanks with identical cross section S . The tanks are coupled by two connecting cylindrical pipes with a cross section S_p and an outflow coefficient $\mu_{13} = \mu_{32}$. The nominal outflow is located at the tank 2, it also has a circular cross section S_p and an outflow μ_{20} . Two pumps driven by DC motors supply the tanks 1 and 2. The flow rates (q_1 and q_2) through these pumps are defined by the calculation of flow per rotation and the control input vector is $U = [q_1 \quad q_2]^T$. The three tanks are equipped with piezo-resistive pressure transducers for measuring the level of the liquid (l_1, l_2, l_3) and the output vector Y is $[l_1 \quad l_2 \quad l_3]^T$. Using the mass balance equations, the system can be represented by:

$$\begin{cases} S \frac{dl_1(t)}{dt} = q_1(t) - q_{13}(t) \\ S \frac{dl_2(t)}{dt} = q_2(t) + q_{32}(t) - q_{20}(t) \\ S \frac{dl_3(t)}{dt} = q_{13}(t) - q_{32}(t) \end{cases} \quad (52)$$

where q_{mn} represents the water flow rate from tank m to n ($m, n = 1, 2, 3 \forall m \neq n$), and can be expressed using the Torricelli law by:

$$q_{mn}(t) = \mu_{mn} S_p \text{sign}(l_m(t) - l_n(t)) (2g | l_m(t) - l_n(t) |)^{1/2} \quad (53)$$

and q_{20} represents the outflow rate with

$$q_{20}(t) = \mu_{20} S_p (2g l_2(t))^{1/2} \quad (54)$$

Under the assumption ($l_1 > l_3 > l_2$) in fault-free or faulty case, 3 linear models have been identified around each of these operating points and the operating conditions are given in Table (1). These 3 local models are supposed

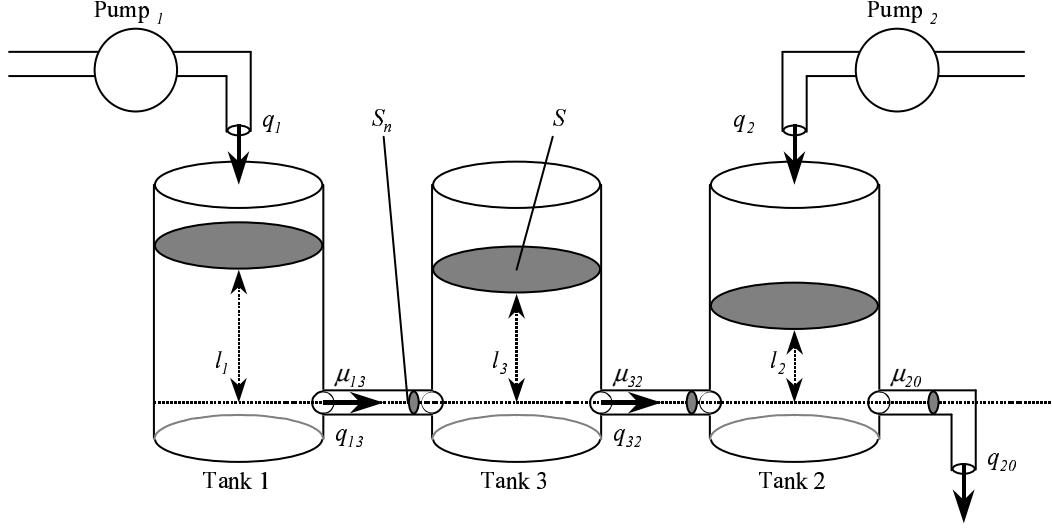

Fig. 2. Hydraulic plant

to be significant for industrial purposes (product concentration, economical rentability,...). In the following, all level or input values are expressed in percentage (%) of the maximum level or input values respectively.

Table 1
Operating Points Definition

Operating Point \mathcal{OP}_j	1	2	3
$Y_e^j = [l_1 \ l_2 \ l_3]^T$	32.26	80.65	80.65
(%)	24.19	24.19	65.32
	28.23	52.42	72.58
$U_e^j = [q_1 \ q_2]^T$	14.60	38.6	20.63
(%)	33.66	9.65	58.16

The linearization of the nonlinear system equations around 3 operating points leads to the following discrete state space representation with a sampling period $T_e = 1s$:

$$\begin{cases} X_{k+1} = A_j X_k + B_j U_k + \Delta_{X_j} \\ Y_k = C X_k + \Delta_{Y_j} \end{cases} \quad (55)$$

where $X \in \mathbb{R}^3$, $U \in \mathbb{R}^2$ and $Y \in \mathbb{R}^3$. State matrices are with appropriate dimensions. In this paper additive actuator faults which can affect a system due to abnormal operation or to material aging, are considered. An actuator fault can be represented by additive and/or multiplicative faults (Theilliol et al., 2002) as follows:

$$U_k^f = \alpha U_k \quad (56)$$

where U and U^f represent the normal and faulty input vector respectively. The term $\alpha \triangleq \text{diag}[\alpha_1, \alpha_2, \dots, \alpha_h, \dots, \alpha_p]$, $\alpha_h \in \mathbb{R}$ such that $\alpha_h = 0$ represents a total lost, a failure of h th actuator and $\alpha_h = 1$ implies that h th actuator operates normally. In the presence of actuator faults and for all operating points, system (52) can also be modelled by a general formulation as in (7):

$$\begin{cases} X_{k+1} = \sum_{j=1}^M \varphi_k^j [A_j X_k + B_j U_k + F_j d_k + \Delta_{X_j}] \\ Y_k = \sum_{j=1}^M \varphi_k^j [C X_k + \Delta_{Y_j}] \end{cases} \quad (57)$$

where $d \in \mathbb{R}^2$ represents the fault. In our case due to the fact that only actuator faults are considered, the faulty matrix distribution F_j is equal to B_j , and due to the system itself $\forall j, B_j = B$. Consequently, F_j is equal to a unique matrix $F = \mathfrak{S} = B$ and the sensitive residual Ω_k^* is directly equal to the estimated fault \hat{d}_k . Moreover, it should be noticed that $\text{rank}(C\mathfrak{S}) = \text{rank}(\mathfrak{S}) = 2$ for adaptive filter synthesis (see section 3.2). The stability analysis of the adaptive filter has been performed as mentioned in section 3.3 and the gains \bar{K}_i (see Appendix A) ensure a quadratic stability.

4.1 Modeling

In this first part, we will show how the multi-model is able to catch the system dynamic behavior (52) with only three linear models (57). Assume that there exists three models M_j defined such that: $M_1 : [l_1, l_2, l_3] = [\text{High}, \text{Low}, \text{Low}]$, $M_2 : [l_1, l_2, l_3] = [\text{High}, \text{Low}, \text{Middle}]$ and $M_3 : [l_1, l_2, l_3] = [\text{High}, \text{High}, \text{High}]$ under the assumption ($l_1 > l_3 > l_2$). These 3 local models are supposed to be significant for industrial purposes. Moreover, it is assumed that each output signal has a gaussian noise $\mathcal{N}(0, 1e - 4)$.

The 3 models are defined as in Table (1) and a first experiment is realized in order to validate the system modeling with these only 3 models. The inputs are varying in their bounded ranges and are generated from the following interpolated combination:

$$U_k = \sum_{j=1}^3 \varrho_k^j * U_e^j \quad (58)$$

where ϱ_k^j is a scheduling variable associated to each operating regime. These inputs are totally fictive and implemented into the nonlinear system (52), but this experiment allows to underline the quality of the multi-models for FDI use. Indeed, in fault-free case in Figure (3), we can see in a) the 3 outputs (l_1, l_2, l_3) from the nonlinear system (52) and the 3 estimated outputs ($\widehat{l}_1, \widehat{l}_2, \widehat{l}_3$) computed from the multi-model (57) with $\varrho_k^j = \varphi_k^j$. The system modeling (multi-model) is effective as the 3 outputs are quasi-similar along the all operating regimes coming from the nonlinear system (52). Furthermore, we can see in the Figure (3). b) the euclidean norms of vectors $e_v = l_v - \widehat{l}_v, \forall v \in [1, 2, 3]$ represented by $\| e_v \|$. These euclidean norms $\| e_v \| < 1.4\%$ underly the effectiveness of multi-model representation. Figure (3).c) represents the corresponding weighting functions and the associated inputs in (3).d).

4.2 Results

The aim of the second experiment is to reach each of the 3 operating regimes described in Table (1) under open-loop consideration both in fault-free and faulty cases. In the following, we will use the outputs coming from the nonlinear system (52) and the specific inputs (58) in order to reach each operating regime.

a) In fault-free case:

Figure (4) shows evolution of the outputs driven in open-loop by the inputs. The changes of the operating points occur around instant 2550s and around instant 12600s. Figure (5) shows the inputs evolution which is directly generated from the following interpolated combination:

$$U_k = \sum_{j=1}^3 \varrho_k^j * U_e^j \quad (59)$$

where ϱ_k^j is a scheduling variable associated to each operating regime. In the following, ϱ_k^j will be considered as the actual probability or actual weighting function which characterized the dynamic behaviour of the nonlinear system. The dynamic evolution of ϱ_k^j is illustrated in Figure (6.b).

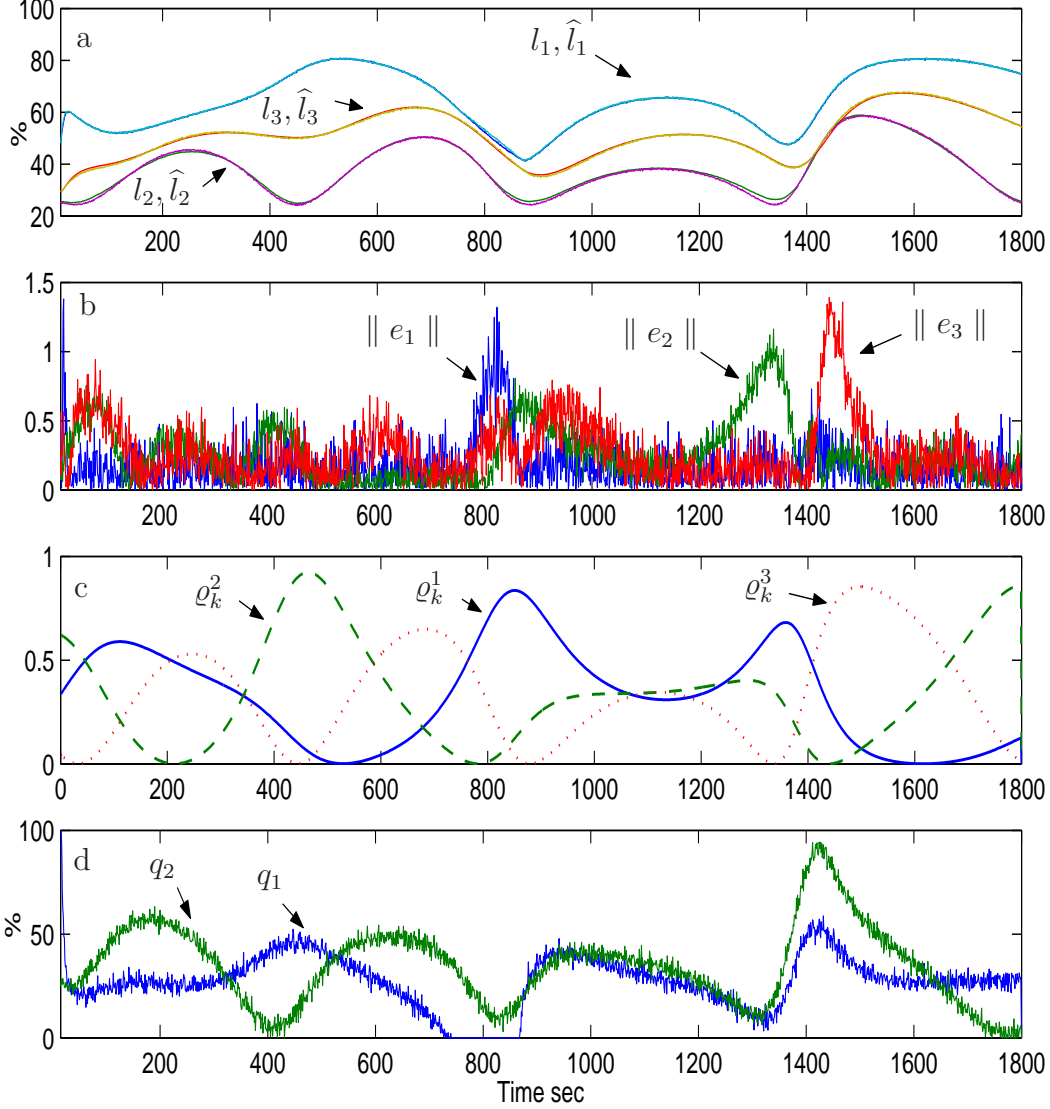

Fig. 3. System modeling: a) outputs l_v and estimated outputs \hat{l}_v b) euclidean norms $\|e_v\|$ c) scheduling functions, d) inputs

In order to evaluate the method, a bank of three classical Kalman filters (8) and a bank of decoupled Kalman filters (25) are synthesized. As illustrated in Figure (6), the dynamic behaviour of weighting functions shows their performance with respect to the actual probabilities ϱ_k^j . Estimated probability functions $\varphi(r_k^j)$ issued from a bank of classical Kalman filters in Figure (6c) or decoupled Kalman filters $\varphi(\gamma_k^j)$ in Figure (6a) are closer to the actual weighting functions in Figure (6.b). Only a small time delay between estimated weighting functions and actual probability exists. The weighting functions are necessary for multi-model representation and for FDI scheme. The ability of FDI scheme to provide good results is directly linked with robust weighting functions design.

Based on the weighting functions coming from decoupled Kalman filters, the residuals generated by the decoupling filter depicted on Figure (7) are defined in equation (46). In this study, two residuals are generated according to two actuator faults. It should be noticed that the residuals Ω_1^* and Ω_2^* which are dedicated to fault magnitude estimation of pump 1 and pump 2 respectively, are zero-mean. The two residuals are only little different from zero during transition from an operating point to another. These imperfections are directly linked to modeling errors but due to low magnitude of these imperfections, the two residuals can be considered as equal to zero.

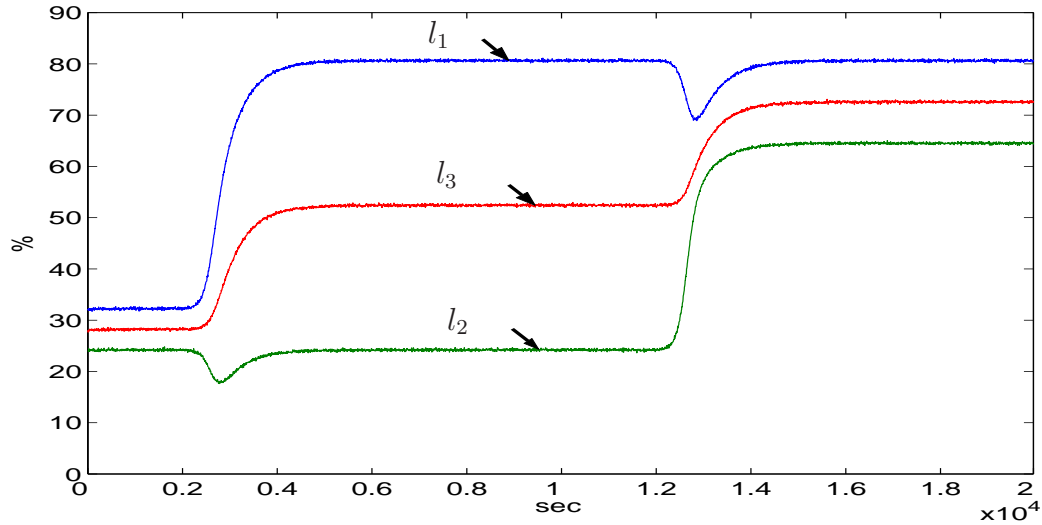

Fig. 4. Outputs in fault-free case

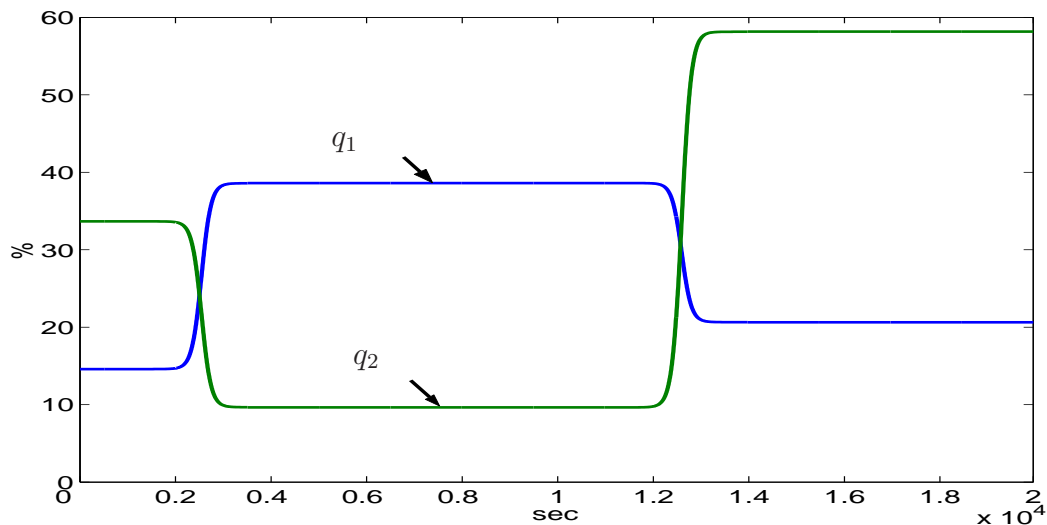

Fig. 5. Inputs in fault-free case

b) In faulty case:

A gain degradation of pump 1 (clogged or rusty pump,...) equivalent to 10%

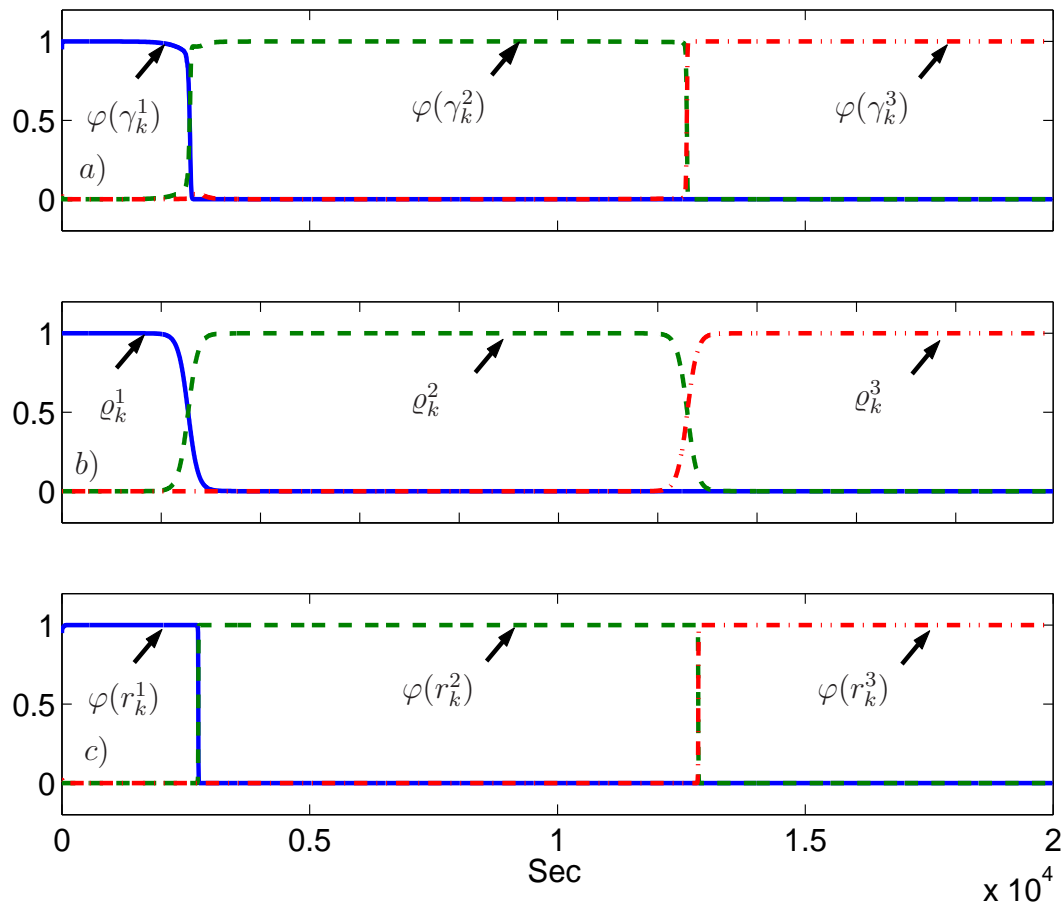

Fig. 6. Probabilities in fault-free case: a) Decoupled Kalman filter b) Actual c) Classical Kalman filter

loss of effectiveness (i.e. 10% of the nominal value) is supposed to occur at $t_1 = 5000$ s after the first set-point change. A second actuator fault is also considered as an abrupt pump degradation on pump 2 with a loss of 10% of effectiveness (i.e. 10% of the nominal value) occurring at $t_2 = 11500$ s (see figure (9)). Consequently, the dynamic behaviour of the levels is also affected by this fault. As illustrated in figure (8), the outputs are different from the previous operating regime. Since an actuator fault acts on the system as a perturbation, the system outputs can not reach again their nominal operating regime. But according to faults with these low magnitude, the system reaches an operating regime close to which is defined first. Based on classical Kalman filters, the estimated weighting functions are also corrupted by the fault as it is shown in figure (10.c): the actual probabilities in figure (10.b) are totally different from Kalman probabilities. However, based on the innovation γ_k^i of the three decoupled Kalman filters, the estimated weighting functions are evolving according to the fault-free case and can be considered as robust against actuator faults (see figure (10.a)).

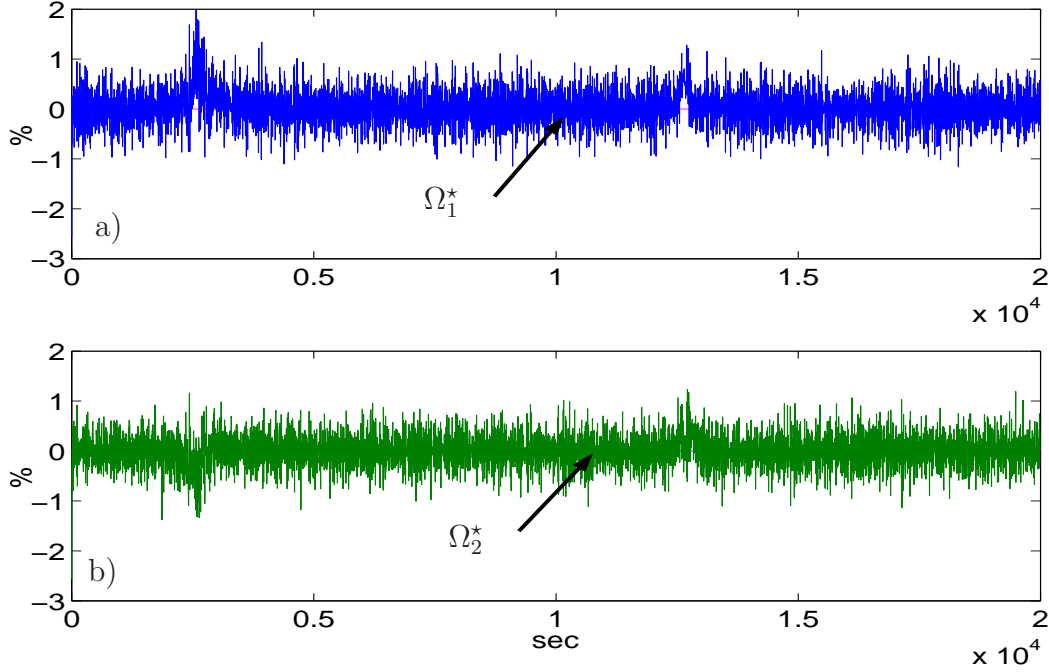

Fig. 7. Sensitive residual from the decoupling filter in fault-free case

The results of the decoupling filter are depicted on Figure (11) which shows the residuals vectors Ω_1^* and Ω_2^* sensitive to faults. We can observe the residuals behaviour where abrupt changes correspond to the two actuator faults. The accurate fault magnitude estimations illustrate the performances and the effectiveness of the decoupling filter. As in fault-free case, during the transition from an operating point to an other, the residuals are sensitive to modeling errors which are not integrated in the synthesis of the decoupling filter. But hopefully, these results make possible to detect, isolate and estimate faults. A fault detection and isolation scheme can be designed directly from fault magnitude estimation. These residuals can be evaluated by statistical test in order to detect bias, like Page-Hinkley test for instance, and faulty actuator can be isolated using an elementary decision logic. The developed FDI strategy is able to detect, isolate and estimate multiple faults as well as to estimate robust weighting functions for system modeling.

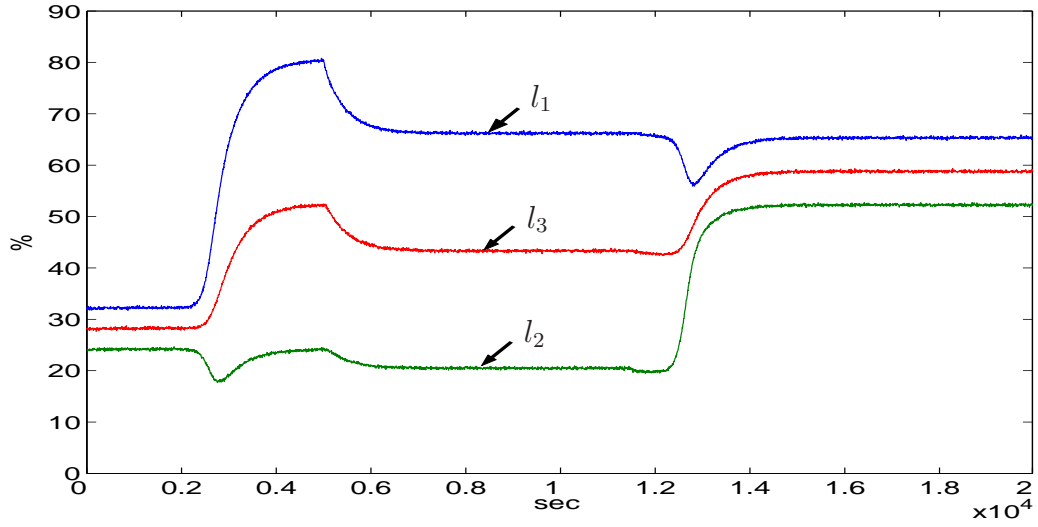

Fig. 8. Outputs in faulty case

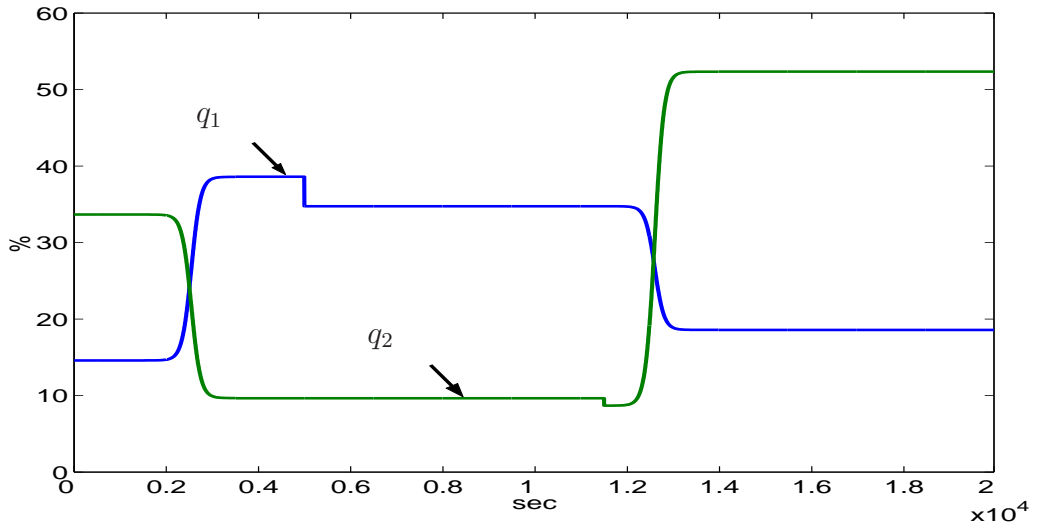

Fig. 9. Inputs in faulty case

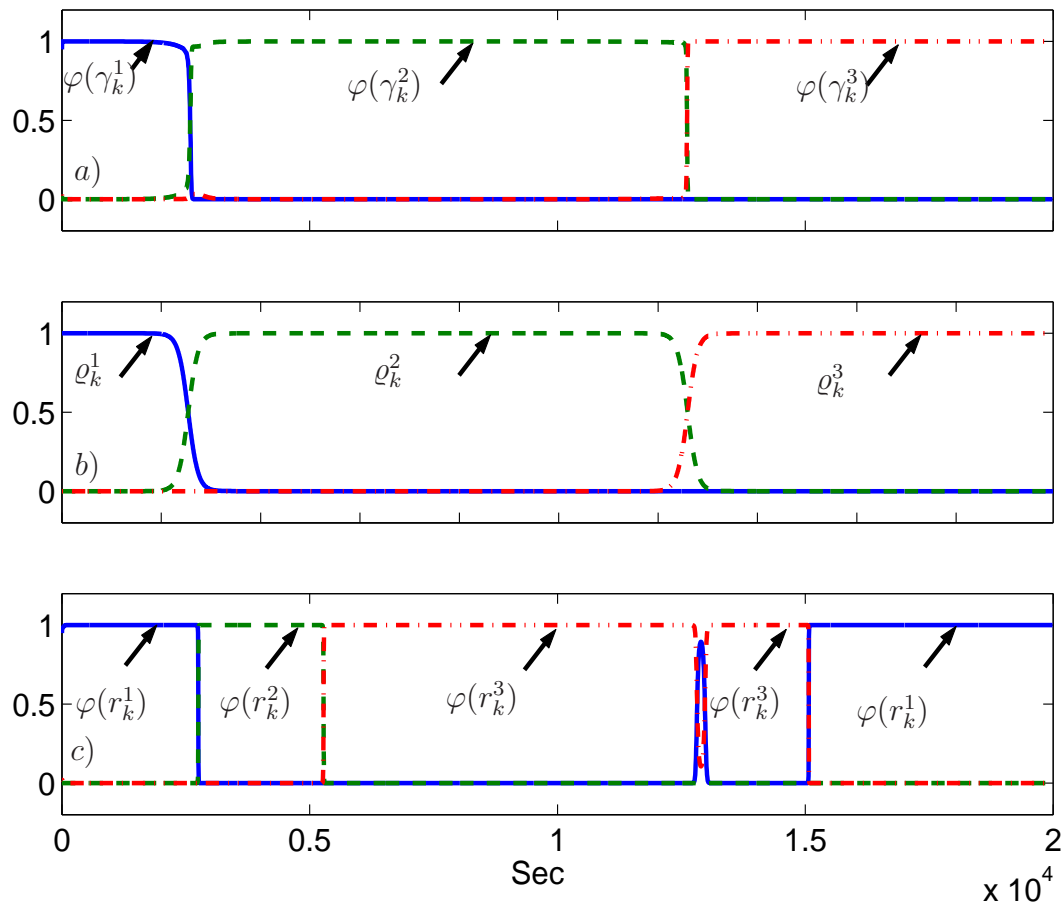

Fig. 10. Probabilities in faulty case

5 Conclusion

The FDI problem for industrial systems described by multi-models has been addressed in this paper. The paper allows to design a FDI scheme in the multi-model framework based on robust weighting functions generation through decoupled Kalman filters. These robust weighting functions allow to reproduce the dynamic behaviour through a wide operating range both in fault-free and faulty cases. In closed-loop, robust weighting functions should be efficient variables in multiple control techniques where for instance, the gain scheduling variable is not measurable or corrupted by fault occurrences. An adaptive filter is designed to detect, isolate and estimate faults through multi-model representation. In order to guarantee stability of the adaptive filter, a stability analysis has been performed using \mathcal{LMZ} . The developed adaptive filter has demonstrated its effectiveness in an hydraulic system for mining processing and water treatment under multiple operating regimes.

Appendix

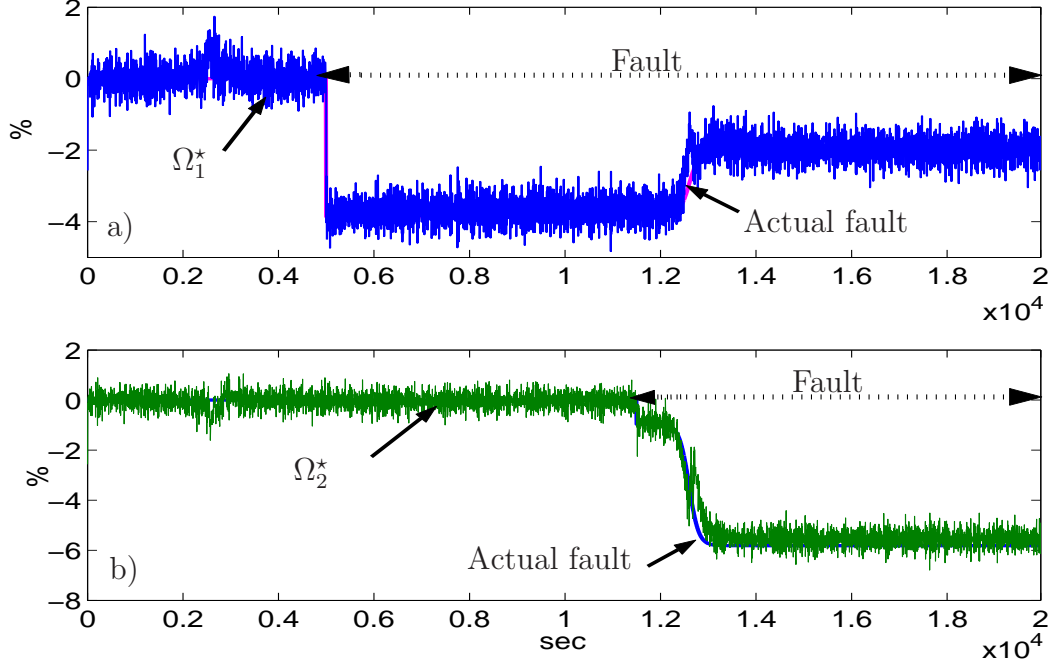

Fig. 11. Sensitive residual from the decoupling filter in faulty case

A. Numerical matrices:

$$\bar{A}_1 = \begin{bmatrix} 0 & 0 & 0 \\ 0 & 0 & 0 \\ 0.1135 & 0.1135 & 0.7725 \end{bmatrix}, \bar{A}_2 = \begin{bmatrix} 0 & 0 & 0 \\ 0 & 0 & 0 \\ 0.043 & 0.043 & 0.914 \end{bmatrix}, \bar{A}_3 = \begin{bmatrix} 0 & 0 & 0 \\ 0 & 0 & 0 \\ 0.0805 & 0.0805 & 0.839 \end{bmatrix}$$

$$\bar{K}_1 = \begin{bmatrix} -0.3 & 0 & 0 \\ 0 & 0 & 0 \\ 0.1135 & 0.1135 & 0.7725 \end{bmatrix}, \bar{K}_2 = \begin{bmatrix} -0.4 & 0 & 0 \\ 0 & 0 & 0 \\ 0.043 & 0.043 & 0.914 \end{bmatrix}, \bar{K}_3 = \begin{bmatrix} -0.35 & 0 & 0 \\ 0 & 0 & 0 \\ 0.0805 & 0.0805 & 0.839 \end{bmatrix}$$

$$B = \begin{bmatrix} 324.68 & 0 \\ 0 & 324.68 \\ 0 & 0 \end{bmatrix}, C = \begin{bmatrix} 1 & 0 & 0 \\ 0 & 1 & 0 \\ 0 & 0 & 1 \end{bmatrix}, P = 1e+6 * \begin{bmatrix} 0.0001 & 0 & 0 \\ 0 & 5.5605 & -0.00053 \\ 0 & -0.00053 & 6.2200 \end{bmatrix}$$

B. Proof of Proposition 1:

As $\text{Rank}[F_1^h \dots F_i^h \dots F_M^h] = 1$, the h th column of F_i gets same direction. This condition could be rewritten as $F_i^h = \alpha_i^h \mathfrak{S}^h$ where α_i^h is a scalar corresponding to the h th matrix column F_i with \mathfrak{S} a matrix composed of constant elements. Thus, coefficients α_i^h can not be equal to zero otherwise rank conditions will not be true. By underlying collinearity of each column, faults contribution in state space representation can be noted as:

$$\left(\sum_{i=1}^M \varphi(\gamma_k^i) F_i^h \right) d_k^h = \left(\sum_{i=1}^M \varphi(\gamma_k^i) (\alpha_i^h \mathfrak{S}^h) \right) d_k^h$$

$$\mathfrak{S}^h \left(\sum_{i=1}^M \varphi(\gamma_k^i) \alpha_i^h d_k^h \right) = \mathfrak{S}^h f_k^h$$

where d_k^h and f_k^h defined h th column vector of the considered vector. This equality is repeated q times to compute column of the matrix \mathfrak{S} as well as the q elements of vector f_k . A full column rank constant matrix \mathfrak{S} and an image of the fault vector $f_k = [f_k^1 \ f_k^2 \ \dots \ f_k^q]^T$ are generated. Each element f_k^h is an interpolation of the h th element of the actual fault vector. Consequently, matrix \mathfrak{S} and the fault vector f_k can be represented as:

$$\left(\sum_{i=1}^M \varphi(\gamma_k^i) F_i \right) d_k = \mathfrak{S} f_k \quad (60)$$

with, $\forall i$

$$\mathfrak{S} = \left[\frac{1}{\alpha_i^1} F_i^1 \ \frac{1}{\alpha_i^2} F_i^2 \ \dots \ \frac{1}{\alpha_i^q} F_i^q \right] \quad (61)$$

$$f_k = \left[\left(\sum_{i=1}^M \varphi(\gamma_k^i) \alpha_i^1 d_k^1 \right)^T \ \dots \ \left(\sum_{i=1}^M \varphi(\gamma_k^i) \alpha_i^q d_k^q \right)^T \right]^T$$

Remark 1: By synthesis, matrix \mathfrak{S} is not unique. With respect to rank conditions defined in *Proposition 1*, scalar α_i^h is not equal to zero.

Remark 2: The unique formulation of the convex representation is not too much restrictive if sensor faults are considered through an augmented state space representation (Park et al., 1994) or in the presence of actuator faults. Indeed, in sensor faults case each matrix F_i are identical (a set of one and zero) and in actuator faults case F_i is equal to B_i .

References

- Adam-Medina, M., Rodrigues, M., Theilliol, D., Jamouli, H., 2003. Fault diagnosis in nonlinear systems through an adaptive filter under a convex set representation. In: Proc. of European Control Conference, Cambridge, U.K, CD Rom.
- Alcorta-Garcia, E., Frank, P., 1997. Deterministic nonlinear observer based approaches to fault diagnosis: a survey. *Control Engineering Practice* 5 (5), 663–670.
- Athans, M., Fekri, S., Pascoal, A., 2005. Issues on robust adaptive feedback control. In: Proc. 16th IFAC World Congress, Prague, Czech Republic.
- Banerjee, A., Arkun, Y., Pearson, R., Ogunnaike, B., 1995. H_∞ control of nonlinear processes using multiple linear models. In: Proc. of European Control Conference, Roma, Italy. pp. 2671–2676.
- Bhagwat, A., Srinivasan, R., Krishnaswamy, P. R., 2003. Multi-linear model-based fault detection during process transitions. *Chemical Engineering Science* 58, 1649–1670.
- Boyd, S., Ghaoui, L. E., Feron, E., Balakrishnan, V., 1994. *Linear Matrix Inequalities in System and Control Theory*. SIAM Studies in Applied Mathematics.

- Chen, J., Patton, R., 1999. Robust model-based fault diagnosis for dynamic systems. Kluwer Academic Publishers.
- Diao, Y., Passino, K. M., 2002. Intelligent fault-tolerant control using adaptive and learning methods. *Control Engineering Practice* 10 (8), 801–817.
- Frank, P., Ding, X., 1997. Survey of robust residual generation and evaluation methods in observer-based fault detection systems. *Journal of Process Control* 7, 403–424.
- Gatzke, E., Doyle, F., 2002. Use of multiple models and qualitative knowledge for on-line moving horizon disturbance estimation and fault diagnosis. *Journal of Process Control* 12, 339–352.
- Gertler, J., 1998. Fault detection and diagnosis in engineering systems. Marcel Dekker Inc. New York Basel Hong Kong.
- Keller, J., 1999. Fault isolation filter design for linear stochastic systems. *Automatica* 35, 1701–1706.
- Leith, D. J., Leithead, W. E., 2000. Survey of gain-scheduling analysis and design. *International Journal of Control* 73 (11), 1001–1025.
- Li, X. R., BarShalom, Y., 1993. Design of an interacting multiple model algorithm for air traffic control tracking. *IEEE Transactions on Control Systems Technology* 1 (3), 186–194.
- Maybeck, P., 1999. Multiple model adaptive algorithms for detecting and compensating sensor and actuator/surface failures in aircraft flight control systems. *International Journal of Robust and Nonlinear Control* 9, 1050–1070.
- Murray-Smith, R., Johansen, T., 1997. *Multiple Model Approaches to Modelling and Control*. Taylor and Francis.
- Narendra, K., Balakrishnan, J., Kernal, M., 1995. Adaptation and learning using multiple models, switching and tuning. *IEEE Contr. Syst. Mag.*, 37–51.
- Ozkan, L., Kothare, M., Georgakis, C., 2003. Control of a solution copolymerization reactor using multi-model predictive control. *Chemical Engineering Science* 2, 1207–1221.
- Park, J., Rizzoni, G., Ribbens, W., 1994. On the representation of sensors faults in fault detection filters. *Automatica* 30 (11), 1793–1795.
- Persis, C. D., Isidori, A., 2001. A geometric approach to nonlinear fault detection. *IEEE Trans. on Automatic Control* 46(6), 853–865.
- Porfirio, C. R., Neito, E. A., Odloak, D., 2003. Multi-model predictive control of an industrial c3/c4 splitter. *Control Engineering Practice* 11, 765–779.
- Rodrigues, M., 2005. Diagnostic et commande active tolérante aux défauts appliqués aux systèmes décrits par des multi-modèles linéaires. Phd thesis, Centre de Recherche en Automatique de Nancy, UHP, Nancy, France.
- Rodrigues, M., Theilliol, D., Sauter, D., 2005. Design of a Robust Polytopic Unknown Input Observer for FDI: Application for Systems described by a Multi-Model Representation. In: Proc. 44th IEEE Conference on Decision and Control and European Control Conference ECC, Sevilla, Spain.
- Stiwell, D. J., Rugh, W. J., 1999. Interpolation of observer state feedback controllers for gain scheduling. *International Journal of Control* 72 (7/8),

- 620–628.
- Tayebi, A., Zaremba, M., 2002. Iterative learning control for non-linear systems described by a blended multiple model representation. *International Journal of Control* 75 (16/17), 1376–1384.
- Theilliol, D., Noura, H., Ponsart, J., 2002. Fault diagnosis and accommodation of three-tank system based on analytical redundancy. *ISA Transactions* 41, 365–382.
- Theilliol, D., Rodrigues, M., Adam-Medina, M., Sauter, D., 2003. Adaptive filter design for FDI in nonlinear systems based on multiple model approach. In: *Proc. IFAC Symposium Safeprocess*, Washington D.C, USA, CD Rom.
- Wan, Z., Kothare, M., 2003. Efficient scheduled stabilizing model predictive control for constrained nonlinear systems. *International Journal of Robust and Nonlinear Control* 13, 331–346.
- Zolghadri, A., Henry, D., Monsion, M., 1996. Design of nonlinear observers for fault diagnosis: a case study. *Control Engineering Practice* 4 (11), 1535–1544.