



HAL
open science

Wood products identification by internal characteristics reading

Cecilia Fuentealba, Christophe Simon, Denise Choffel, Patrick Charpentier,
Daniel Masson

► **To cite this version:**

Cecilia Fuentealba, Christophe Simon, Denise Choffel, Patrick Charpentier, Daniel Masson. Wood products identification by internal characteristics reading. IEEE ICIT '04, 2004 IEEE International Conference on Industrial Technology, Dec 2004, Hammamet, Tunisia. pp.763- 768, 10.1109/ICIT.2004.1490171 . hal-00154536

HAL Id: hal-00154536

<https://hal.science/hal-00154536>

Submitted on 14 Jun 2007

HAL is a multi-disciplinary open access archive for the deposit and dissemination of scientific research documents, whether they are published or not. The documents may come from teaching and research institutions in France or abroad, or from public or private research centers.

L'archive ouverte pluridisciplinaire **HAL**, est destinée au dépôt et à la diffusion de documents scientifiques de niveau recherche, publiés ou non, émanant des établissements d'enseignement et de recherche français ou étrangers, des laboratoires publics ou privés.

Wood Products Identification by Internal Characteristics Readings

C. FUENTEALBA¹, C. SIMON², D. CHOFFEL³, P. CHARPENTIER⁴ and D. MASSON⁵

^{1,2,3,4}CRAN - Center of Research of Automatic Control of Nancy, Faculty of Sciences, B.P. 239 - 54506 Vandœuvre-les-Nancy, France, e-mail : cecilia.fuentealba@cran.uhp-nancy.fr

⁵LERMAB - Wood Research Laboratory, Epinal, France, e-mail: daniel.masson@enstib.uhp-nancy.fr

Abstract—The traceability of products is an ever growing demand of quality for many areas. In the manufacturing process, traceability is required to follow-up all the production cycle of the product. Consequently, product traceability can result in a great control of the production process, thus allows improving control of production tools and reacting to their deficiencies. For wood industries, implementation of current identification techniques is not easy, due to the extremely variable nature of the wood and the particular features of the manufacturing process. In this article, we implement a traceability tool within a manufacturing process using the intrinsic characteristics of the wood product. The goal is to achieve an individual identification of products. We use a microwave sensor to obtain a unique signature of the product and then we develop its identification. Thus, the identification process on the basis of a numerical product signature can be considered as a discrimination problem as for the nearest neighbor method. We evaluate the error rate of identification by a Monte Carlo simulation of the process. This work shows the high potential of developing an identification system based on the use of the intrinsic characteristics of product.

Key Words—wood product, automatic identification, traceability, k -nearest neighbors

I. INTRODUCTION

The traceability of products is a demand of quality that has increased, notably in sanitary and food areas. Generally, in the production process, this demand of traceability is required to trace back the production cycle of a product or to finely lead the production policy into enterprises by a sharp management. The traceability of products brings to the mastery of the production process and therefore to a best capacity of controlling and reacting on production tools.

Many technical solutions have been achieved to realize this traceability. We know about sticky labels and bars codes that allow a good identification of products and their traceability, when the information system of the enterprise is correctly defined and maintained. But, this technique induces the use of "consumable" whose cost can become important according to the type of manufacturing process and products. This solution stays grandly appreciated in the food area.

In the manufacturing production area, we find electronic tags whose decreasing costs render them more interesting, even if it remains costly. Nevertheless, possibilities considered by Chaxel in [1] shows that possibilities are more important thanks to their capacity of data storage.

The wood industry does not escape the demand of trace-

ability. However, the lively nature of wood and the type of manufacturing processes met does not allow an easy use of labeling techniques of each product, except in some specific production steps with an often important cost.

In this article, we are interested in the feasibility of a traceability tool. It consists in the identification of a wood product inside a manufacturing process, using its internal characteristics. The goal is an individual identification towards an increase of performances of the production system.

In a first part, we describe the concept of the wood signature, by highlighting that the heterogeneous nature of wood can be finally turned to our advantage in an identification goal. Then we present the potential integration of the system in the manufacturing process.

In a second part, the measurement system is specified. We develop the choice and the description of a microwave sensor, and also the methodology to perform the identification.

Finally, we expose the experimentation on a specific step of the manufacturing process. We conclude on the performances obtained and the future works.

II. WOOD AND ITS SIGNATURE

Wood is a heterogeneous and anisotropic material. It has an important variability in its structure that industries take into account for its transformation. Precisely, it's observed the presence of features such as the knots, pitch pockets and cross grain. Each product presents all or some of these variations and has its own variations even if it comes from the same log [2]. These variations come from growth conditions of the tree and also from sawing conditions of logs.

We make the assumption that each wood product presents its own characteristics that differentiate it from others [3]. These characteristics can be used as a signature. The interest of this approach is that the product identity is not lost since the means to identify it are embedded within. That is not the case with identification systems like bar codes or electronic tags. Moreover, the addition of consumable on the product is not compatible with some manufacturing steps like planing, moulding or wood impregnation process.

Our approach can be compared to the solutions presented in ([4],[5]) in biometrics applications. There exist few references on this field applied to the wood products. The only reference for wood products is Chiorescu [6] where the identification is based on a measurement system of the external

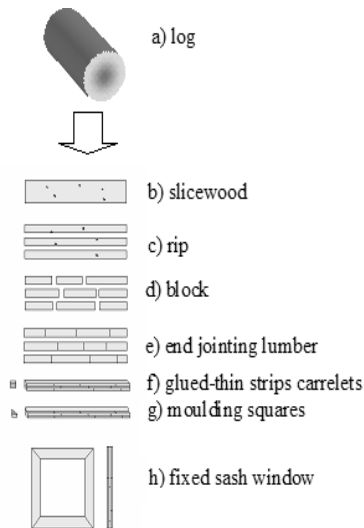

Fig. 1. Divergent and convergent flow production

envelope of the logs.

III. MANUFACTURE FOLLOW-UP

The study of the identification system is carried out in the framework of the improvement of manufacture follow-up for windows business. The goal is to be able to manage the manufacture cycle of a window by knowing the totality of its components, thanks to an identification process.

A. Manufacturing process

Wood transformation processes are particular because they present a divergent flow of materials, then a convergent one (Fig. 1). Moreover, no predefined order of appearance is met in the first steps of the production process because the operator chooses subjectively the material according to size criteria, quality and equipment. The initial decision does not take into account the final product, unless a follow-up system is implemented. The identification at each production step is then an efficient means to the realization of this follow-up.

The complete follow-up of products will help in the improvement of the performances of the process that is necessary in the traceability context. The implementation of identification technology is not easy due to the convergent and divergent character of the product flow, the diversity of products and the usual loss of the FIFO order.

Windows manufacturing consists in the transformation of semi-finished products like moulding carrelts to the fixed sash and leaf of windows according to the process described below.

The production is launched on the basis of a client order that defined the type of windows desired in dimension, species, tint and hardware. Moulding carrelts are taken in stocks according to their section and lengths and are transformed into manufacturing stages. The identification allows knowing the client specifications.

B. Identification process

The identification system will be placed at the input and the output of each step of the process breaking the FIFO (First-In First-Out) sequence. The product signature measured in the output of the process at each step will be compared to products signatures already entered in the production tool.

When the wood transformation is only superficial like in the sanding process and in the stocking, the input and output signatures are directly projected in the same referential in order to be compared for identification of the product.

When the transformation is deeper as in the moulding process with a reduction of thickness and/or change of shape of the product, the input signature is projected in the referential of the output, by modeling the transformation made by the process. Fig. 2 shows the architecture chosen to accomplish the production follow-up by products identification in the manufacturing process.

IV. IDENTIFICATION SYSTEM

A. Sensor and measurement process

Many kinds of sensors have been used in wood manufacturing processes that cover the scale of electromagnetic wavelengths ([7], [8], [9]). Our concept is based on the measurement of internal properties of products obtained by non destructive techniques in transmission mode like γ -rays, X-rays, microwaves or ultrasound. However, the cost and the complexity of the implementation of the two first techniques are damning factors.

The microwave technique is employed in our laboratory since a few years. The initial application is the detection of knots and the estimation of the mechanical properties of wood products [10]. It is naturally the sensor which supports our concept. The ultrasound technique is also appropriate and constitute a future way of research.

The acquisition of the signature is obtained on a test bed as shown on Fig. 3. The microwave sensor is composed of an emitting part (10 GHz frequency, 100 mW power) and 16 aligned receivers. The product circulates between the transmitter and receivers. The signature is digitized to be processed on a computer. Two photoelectric cells allow the detection of the product and its length is known thanks to the addition of an encoder. The lengthways resolution of the sampling has been fixed to 5 mm.

Microwaves interact with the material according to its dielectric properties [11]. The humidity, the temperature, the positioning and even vibrations are going to modify the signature signal of the product received by sensors. Some of these factors will be able to be limited and others will have to be taken into account. Moreover, relative dimensional modifications to the manufacturing process will have to be taken into account for an effective identification to each stage of the process.

The magnitude of the signal (Fig. 4) is a numerical value

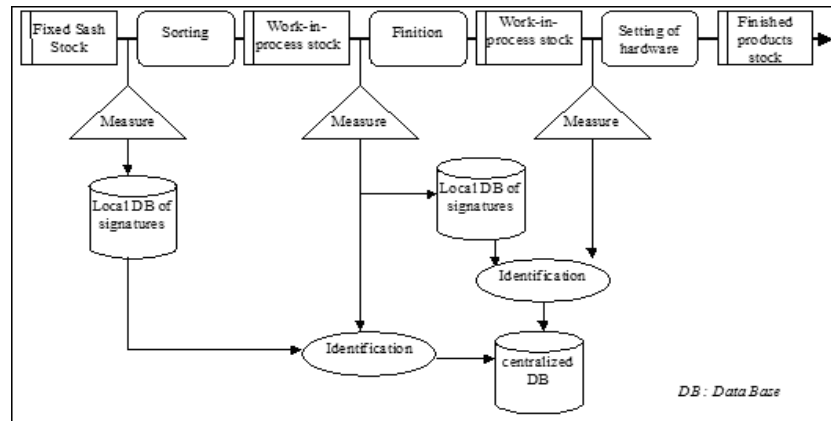

Fig. 2. Instance of manufacturing process and its follow-up architecture

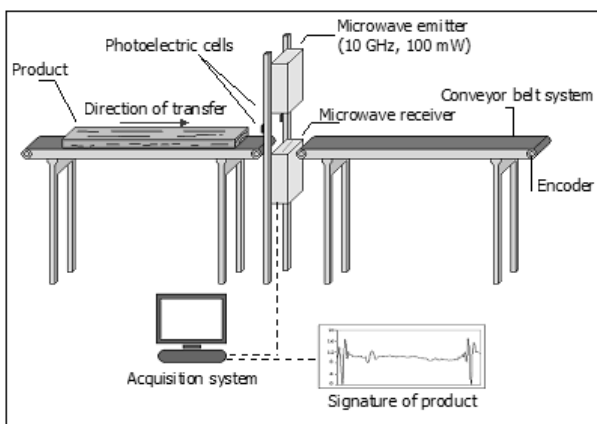

Fig. 3. Microwave test bed

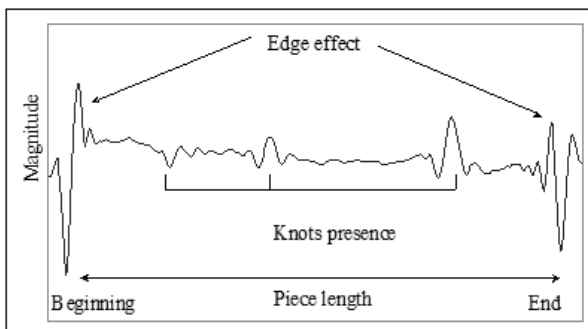

Fig. 4. Example of a rough microwave signal

characterising the power of the wave received after its passage through the product. Fluctuations in the beginning and the end of a measurement correspond to edge effects due to changes of air-wood medium.

For economical reasons, the study has been conducted on the use of only one receiver among the 16. The receiver is placed in central position as shown on Fig. 5. Indeed, the same area of wood has to be analyzed in input and output of a production step with the same receiver even if the product has been turned.

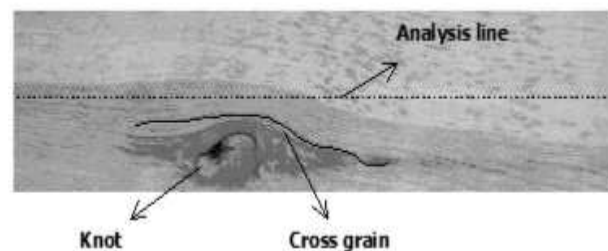

Fig. 5. Acquisition path centered on the piece

B. Identification

The identification by a signature of characteristics of an individual or an object is a classic pattern recognition problem ([12],[13],[14]). The identification process consists in the association of a signature of characteristics whose identity is unknown, linked to a set of characteristic values, to a reference identity. The identification process exploits the bijective function between attribute values and identities by the reconciliation of object attribute values with unknown identity to those of attributes of reference objects.

If we possess only one signature of reference per object, each signature is the unique prototype of the class of identity. We are then in a discrimination context like one nearest neighbor.

This method is well known in pattern recognition problems. The performances of the identification process are contextual since it depends on the kind of signatures available, and also on the choice of attributes [15]. This choice depends on available measurement systems, modifications of attribute values consecutively to a products transformation and technical or economical constraints (production rate, computing time, cost of the sensor ...).

Manufacture follow-up by individual products identification will be efficient if one defines invariant attributes to encountered transformations. Unfortunately, there is no clear rule for this definition.

As we have specified it in the previous paragraph, the

choice of a microwave sensor is natural in the wood manufacturing area and presents the interest to show deep characteristics of the product. Transformations of surface have a less significant effect on measures obtained by microwave transmission through the product. But, deep transformations will ask specific studies.

From measures taken on products to form signatures, two approaches can be used. The first approach consists of the extraction of numerical characteristics from measured signatures [16]. One finds usually descriptions of signals (average, standard deviation, slope ...) or characteristics of physical structure (number of knots, length ...). This standard approach has the advantage to reduce the quantity of information and concerns problems where the number of products is important. This is not our case. In addition, characteristics have to be invariants to transformations operated on products and the information filtering that they realize on signals does not have to create more ambiguity. The second approach consists in using the numerical signal directly obtained by the microwave sensor as characteristics. There is no filtering of information but an important mass of data. This is not a problem here since the production stocks contain a limited number of products.

Finally, some signal transformations can be used (Fourier, Hadamard, wavelets ...) to provide a more appropriate representation thanks to invariance properties (shift, rotation, scale ...).

V. EXPERIMENTATION AND RESULTS

Experimentation has begun with the digitization of 81 boards of *Pinus sylvestris* with the following dimensions $25 \times 110 \times 1500$ mm. The feasibility of identification can be demonstrated with a time transformation that is a stocking process and some variations in board orientations. As define before, the goal of identification is then to find the identity of an output signature from the input signatures database.

A. Signals

Considering the length of products and the longitudinal resolution, each product signature is constituted of 310 points of measure. The repeatability of the measurement system depends both on the microwave sensor and the conveyor belt system. For the first, the reliability has been shown from the first applications of this system [17]. For the second, we are going to see that it has its importance according to the measure, as stocking steps do not assure to measure the product on the same face and the same orientation (Fig. 6a). We have four possible signals for a product as shown on Fig. 6b where all signals have been turned to be put in correspondence.

As the microwave measurement works by transmission - projection, signals of measure are close to each other for two reasons. The first reason is the positioning of the sensor at the middle of the board. In this case, even if the board turns to another orientation, the microwave flux goes ap-

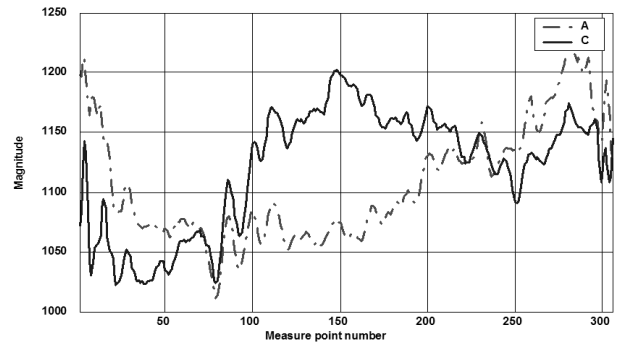

Fig. 7. Measurement of a signature of warped product by its opposed faces

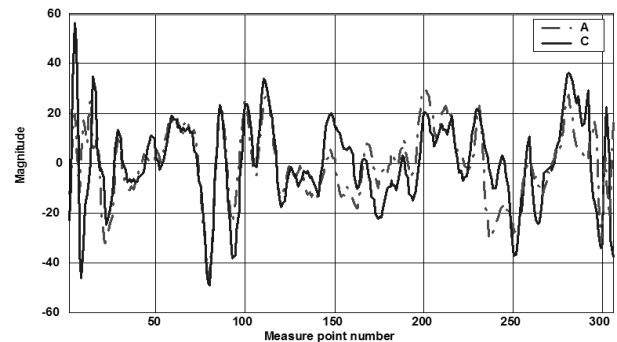

Fig. 8. Corrected signals

proximately through the same part of the board. The second reason concerns the orientation of the internal structure of the product as regards to the transmission axis. So, we can make couple of signals with orientations (A-C) and (B-D) without reversing signals. There are some factors that induce variations in signals appearance. The signal reception level depends on the distances between the receiver and the board and between the board and the receiver. Moreover, warped pieces cause an important variability in measures near board edges. Fig. 7 shows this variability on a warped product measured on its opposite faces (A-C).

We note that the general curvature of a warp board is observable on signals and is different according to the face observed. This curvature is not a significant characteristic of a board and should be removed by a signal processing treatment. A first low-pass filter allows eliminating the inherent measure noise of the microwave sensor. A second processing consists of subtracting the general curvature estimation of the measurement signal in the least square sense by a polynomial of degree 7. This degree has been heuristically chosen from the general curvature observation of signals met in the database. After correction, signals are straightened and centered on 0 as shown on Fig. 8. We can see that signals measured on faces A and C become closer but stay a little bit different. So, it may produce identification error.

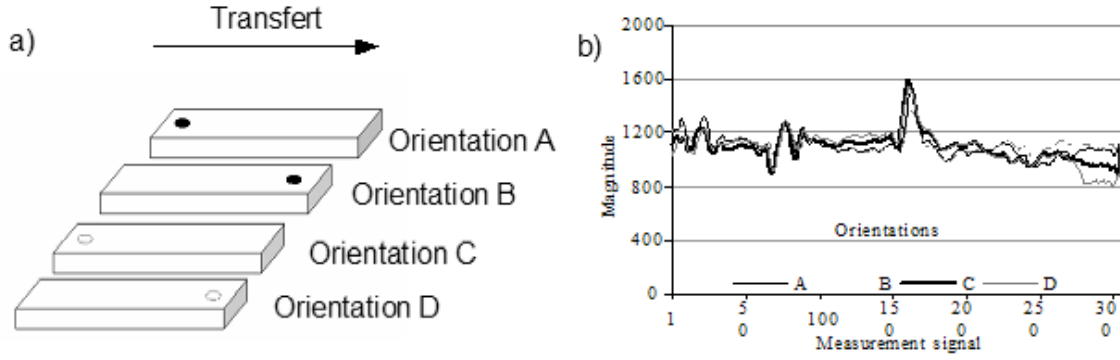

Fig. 6. a) Measurement orientations, b) 4 signals over 4 orientations

B. Discrimination

Corrected signals are used as characteristic signatures. The discrimination in the nearest neighbor sense is used by computing a distance between the different signatures represented by a point in a space with 310 dimensions corresponding to the number of measure points. In many works on pattern recognition, general Euclidean distance is used. The following equations define two kinds of computation:

$$d_{xy} = \left(\sum_{i=1}^{310} (x_i - y_i) M(x_i - y_i) \right) \quad (1)$$

$$d_{xy} = \sum_{i=1}^{310} |(x_i - y_i) M| \quad (2)$$

where x is the unknown signature and y a known one among those of reference, x_i is the i^{th} characteristic of x , y_i the i^{th} of y and M is a weighting matrix.

According to the value of M , relation (1) takes different names. The identity matrix defines the Euclidean distance, the inverse of the variance-covariance matrix defines the Mahalanobis distance and a heuristic choice in the diagonal values conducts to the pondered Euclidean distance. Another way to compute the distance between x and y is the general Manhattan distance also called the city block distance defines by relation (2). We have tested these two weighted forms in order to ponder the distance in the edges of the measurement signals. The values have been chosen in relation with our confidence in the measurement process in these parts of the board. The weighting coefficients are defined according to the curve shown on Fig. 9.

C. Confusion coefficient

In the nearest neighbor method, the identity attached to the less distanced signature is the most probable identity. After sorting by increasing distances between the each known signature and the unknown one, it's possible to evaluate a confusion degree by computing the ratio of the two smallest distances. This ratio allows us to know if the decision making to the nearest neighbor is done with a great risk of error. This confusion degree is the well known ambi-

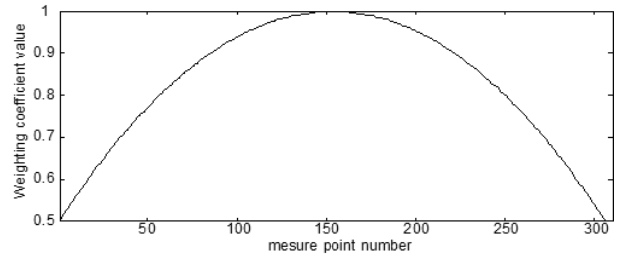

Fig. 9. Curve of weighting coefficients

guity degree in Bayesian decision rule [18] and allows us to evaluate the risk of confusion in the decision taken.

D. Simulations

To experiment the feasibility of individual product identification, we have collected signals about 81 boards on a stocking process. In order to test the feasibility of individual product identification, we worked with the 81 boards digitized with the orientations A and C. Different simulations have been made according to:

- the orientation of the unknown signature and the orientations contained in the reference database,
- the definition of the nearest neighbor space.

Through these simulations, the performance of the identification is evaluated. An error rate is computed at the end of each simulation. It is the ratio between the number of incorrect identifications and the total number of identifications.

Our first simulation consist in characterizing each signal by its average, standard deviation, slope, minimum and maximum value and the number of knots. All combinations of characteristics have been tested and the best error rate is about 4.5% when testing signatures in way A only. The error rate grows to 31% when identifying signatures in way C and a database of signatures in way A.

A second simulation has been done with the nearest neighbor applied to the Fourier Transform of each signal. When comparing signatures in way A to them, the error rate is about 30%.

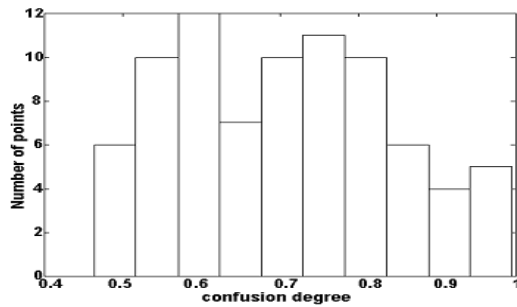

Fig. 10. Histogram of confusion in decision making, Manhattan distances

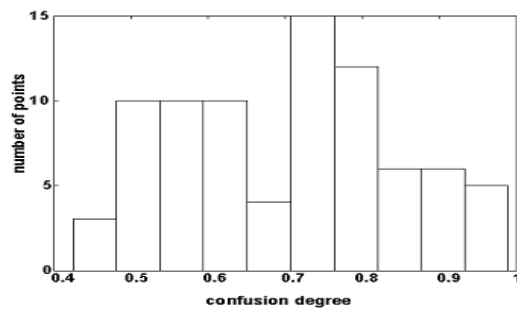

Fig. 11. Histogram of confusion in decision making, Euclidean distances

The last simulation consists in using directly signals of measured points. The identification of signature in way A with themselves has been tested because it naturally conducts to 0% of error rate. The error rate has been evaluated with signatures in way A as references and signatures in way C as unknown signatures. It represents the most unfavorable case in this part of the process. By using the Manhattan distance, we have obtained an error rate close to 2.5% and a rate of confusion going from 0.5 to 1 as shown by histogram in Fig. 10. By using the Euclidean distance, in the same experience, the error rate is close to 1.5% and the confusion degrees are grouped in histogram on Fig. 11.

Error rates of identification are weak and entirely comparable for the two distances used. It is interesting to notice that in some cases a correct identification was made but with a high risk of confusion.

Finally, we have realized a simulation of the stocking process in order to evaluate the sensibility of the error rate to the sequence of signature choice, by a Monte-Carlo simulation. This simulation shows how contextual is the identification process. When an unknown signature is misclassified, the false reference signature comes out the database and it produces a domino effect. Thus, the error rate over 30 simulations is in 1.5% to 11%.

E. Conclusion and prospects

We have shown that it was possible to recognize products within a production process, by the analysis of their intrinsic characteristics. A microwave sensor measures intrinsic

characteristics of the product that we consider as a signature of its identity. The identification process is the well known nearest neighbor method and shows an acceptable performance for the problem of traceability in wood manufacturing industry.

The application on the stage of non-FIFO stocking has been chosen for its usual presence in production process. The product has been considered according to different orientation as in the some real process. Nevertheless, we have to continue the work by taking into account the product transformations.

REFERENCES

- [1] F. Chaxel, E. Bajic, "Auto-ID Mobile information system for vehicle life cycle data management", in Proceedings of IEEE International Conference on Systems, Management and Cybernetics, vol.4, 2002
- [2] J.C.F. Walker, Primary wood processing, principles and practice, Chapman & Hall, London: 1992
- [3] P. Charpentier and D. Choffel, "The feasibility of intrinsic signature identification for the traceability of pieces of wood", Forest Products Journal, Vol.53, n°9, July 2003
- [4] A. Jain, L. Hong, S. Pankanti, "Biometric identification", Communications of the ACM. Vol.43 n°2, 2000
- [5] Zhong Jin and Jing-Yu Yang, Face recognition based on the uncorrelated discriminant transformation, Pattern Recognition, Vol. 34, 2001, pp. 1405–1416
- [6] S. Chiorescu, P. Berg and A. Gronlund, "The fingerprint approach: using data generated by a 2-axis log scanner to accomplish traceability in the sawmill's log yard", Forest Products Journal, Vol 53, n°2, 2003, pp.78–86
- [7] R. Guzenda, W. Olek, H. Baranowska, "Identification of Free and Bound Water Content in wood by means of NMR Relaxometry", 12th Int. Symposium on Nondestructive Testing of Wood, Sopron Hungary, 13-15 december 2000
- [8] Y. Sasaki, M. Hasegawa, "Ultrasonic Measurement of Applied Stresses in Wood by Acoustoelastic Birefringent Method", 12th Int. Symposium on Nondestructive Testing of Wood, Sopron Hungary, 13-15 december 2000
- [9] T. Tanaka, F. Divos, "Thermographic Inspection of Wood", 12th Int. Symposium on Nondestructive Testing of Wood, Sopron Hungary, 13-15 december 2000
- [10] D. Choffel, "Automation of timber mechanical grading, Coupling of vision and microwaves", in Proceedings of SPIE-Machine Vision Systems for Inspection and Metrology, VIII, Boston, 1999
- [11] G.I Torgonikov, Dielectric properties of wood and wood-based materials, Springer Verlag, New-York: 1992
- [12] A. Jain, L. Hong, S. Pankanti and R. Bolle, "An identity authentication system using fingerprints", in Proceedings of the IEEE, Vol. 85, n°9, 1997, pp. 1365–1388
- [13] C. Simon, E. Levrat, J. Bremont and R. Sabourin, "A Fuzzy Perception for Off-line Handwritten Signature Verification", in Proceedings of the first Brazilian Symposium on Document Image Analysis, 1997, pp. 261–272
- [14] J.R. Parker, "Simple distance between handwritten signatures", in Proceedings of Vision Interface 2002, Calgary-Alberta, 2002, pp.27–29
- [15] T.M. Cover and P.E. Hart, "Nearest neighbor pattern classification", IEEE Trans, Inform. Theory, vol. IT-13, Jan. 1968, pp. 21–27
- [16] D. Choffel and P. Charpentier, "Traceability of wood products : A structural approach for pattern recognition", in Proceedings of 10th IFAC Symposium on Information Control Problems in Manufacturing INCOM 2001, Vienne-Austria, 20-22 Sept. 2001
- [17] D. Choffel, B. Goy, P. Martin and D. Gapp, "Interaction between wood and microwaves - Automatic grading application", in Proceedings of 1st seminar on scanning technology and image processing on wood, Luleå University-Sweden, 1992
- [18] M. Ménard, "Fuzzy clustering and switching regression models using ambiguity and distance reject", Fuzzy Sets and Systems, vol. 122, n°3, 2001, pp.363–400.