



HAL
open science

Data validation and diagnosis using interval analysis

José Ragot, Didier Maquin

► **To cite this version:**

José Ragot, Didier Maquin. Data validation and diagnosis using interval analysis. Workshop on Advanced Control and Diagnosis, Nov 2005, Mulhouse, France. pp.CDRom. hal-00151263

HAL Id: hal-00151263

<https://hal.science/hal-00151263>

Submitted on 2 Jun 2007

HAL is a multi-disciplinary open access archive for the deposit and dissemination of scientific research documents, whether they are published or not. The documents may come from teaching and research institutions in France or abroad, or from public or private research centers.

L'archive ouverte pluridisciplinaire **HAL**, est destinée au dépôt et à la diffusion de documents scientifiques de niveau recherche, publiés ou non, émanant des établissements d'enseignement et de recherche français ou étrangers, des laboratoires publics ou privés.

Data validation and diagnosis using interval analysis

José RAGOT and Didier MAQUIN

Centre de Recherche en Automatique de Nancy - UMR 7039

CNRS-INPL-UHP, 2 avenue de la forêt de Haye. 54516 Vandoeuvre-les-Nancy Cedex

(jose.ragot, didier.maquin)@ensem.inpl-nancy.fr

Abstract

Parameter or state estimation plays an important role in numerous engineering fields such as function estimation, system identification, controller design, data validation, diagnosis. Classical estimation methods compute the parameters so that the mean-squared error between the model output and the observed response is minimized. A robust approach to the estimation problem may be used when the error is bounded. This approach, called parameter set estimation, aims to find the feasible set of parameters consistent with all observed data and error bounds. State and parameter estimation problems are usually solved by statistical approaches, which are relevant when an explicit characterization of the perturbances is available. Unfortunately, it is often difficult to get this information and, in some cases, it is more natural to assume that all perturbations (measurement and modelling errors, model uncertainty), belong to a known set. In this case, guaranteed estimation, also known as bounded-error estimation, allows the characterization of the whole set of state or parameter vectors that are compatible with the measured data, the model of the process and the error bounds. This paper deals with model based data validation and fault detection-isolation considering the effect of model uncertainty, these uncertainties being represented by interval values.

1 Introduction and historical point of view

The parameter estimation using the set-membership approach started in the eighties, where the strategy initially consists in circumscribing the domain describing model uncertainties by a simple form. This approach was originally designed to deal with a model linear in uncertain parameters and characterised by a bounded equation error. The problem of parameter estimation amounts to the determination of the set of constant parameter values called the Feasible Parameter Set (*FPS*). This set is compatible with all the available observations which are consistent with the bounds of the equation error and the model structure.

For models linear in their parameters, the *FPS* is a convex polytope which can be approximated by ellipsoids [31], [55], or orthotopes [45] containing it. The work in [73] on the one hand, and [47] on the other, used polytopic domains. The main results are presented in the book published by Milanese et al. [46].

For models nonlinear in their parameters, various methods exist for determining an approximation of the *FPS*, linear techniques have been extended to the nonlinear case using multiple linearisation of the model [17]. More recent results have been obtained [37] in order to solve the problem of nonlinear bounded-error estimation using set inversion techniques and based on interval analysis, there make it possible to characterise the *FPS* by enclosing it between internal and external unions of boxes.

For specific model structures, it is possible to obtain sets of linear inequalities describing a domain approximating the *FPS* [50], [27].

In the field of diagnosis, one common approach is the so-called model-based diagnosis. The model represents the behavior of the system to be diagnosed. If the behavior of the observed system differs from the estimation given by its model, we conclude that a fault has occurred. However, an accurate and complete model of a system is difficult to obtain and almost never available. Moreover, the parameters of a system may vary with time in an uncertain manner, and the magnitude of disturbances and noise are partially unknown so that they cannot be exactly modelled. An alternative approach is to represent uncertainty in models with interval parameters; moreover, the noise affecting the measurement or the dynamic of the system may also be given as intervals. One of the first work on that subject is presented in [23]. Later [21] and [61] propose a technique based on interval for the detection et isolation of faults of sensors in the case of static linear models while [14] treats the dynamic linear model.

As it will be further explain, interval representation may be used either for parameter of a model or state of a system. Thus, there are strong links between parameter and state estimation; for that reason, in our paper, the same tools are used.

In what follows, section 2 presents the estimation of parameters in the context of bounded-error data. Section 3 gives a general formulation of the linear regression. State estimation using observer formalism is exposed in section 4. Section 5 and 6 are devoted to data validation and reconciliation for static and dynamic systems. A important list of references complete the apper, but only some of them are addressed in the text.

2 Parameter set estimation from bounded-error data

Parameter set estimation allows to compute the feasible parameter set of a model using data corrupted by errors, these errors being bounded. For example, consider the linear system $f : \mathbb{R}^m \rightarrow \mathbb{R}$ excited by $x(k) \in \mathbb{R}^m$ and whose output is parametrized on $\theta \in \mathbb{R}^m$:

$$y(k) = x^T(k)\theta, \quad k = 1..N \quad (1)$$

The objective of identification is to find the values of the parameters θ using available informations on the output:

$$y_m(k) = y(k) + \varepsilon(k), \quad k = 1..N \quad (2)$$

where ε is an additive measurement noise. In the classical estimation methods, the parameters are adjusted so as to minimize the mean-squared error between the model output $y(k)$ and the measurements $y_m(k)$. In the bounded error context, the approach is different. The measurement error is supposed to be bounded:

$$|\varepsilon(k)| \leq \delta \quad (3)$$

Here for sake of brevity, the bound δ is constant all along the time. The error between the model output and the observed output is therefore bounded and we have to satisfy the constraints:

$$|y_m(k) - y(k)| \leq \delta \quad (4)$$

Thus, the set of parameters consistent with the k th data and the bound δ is defined by:

$$\Theta_k = \{\theta : |y_m(k) - x(k)^T\theta| \leq \delta\} \quad (5)$$

Θ_k corresponds to a hyper-strip in \mathbb{R}^m defined by the intersection of two affine halfspaces:

$$H_k^- = \{\theta \in \mathbb{R}^m : x(k)^T \theta \leq y_m(k) - \delta\} \quad (6a)$$

$$H_k^+ = \{\theta \in \mathbb{R}^m : x(k)^T \theta \geq y_m(k) + \delta\} \quad (6b)$$

and thus:

$$\Theta_k = H_k^- \cap H_k^+ \quad (7)$$

The set of parameters consistent with all observations is the feasible set defined by:

$$D_N = \bigcap_{k=1}^N \Theta_k \quad (8)$$

where D_N can be easily computed using the recursion:

$$D_k = D_{k-1} \cap \Theta_k, \quad k = 1..N \quad (9a)$$

$$D_0 = \mathbb{R}^m \quad (9b)$$

However, D_N may have a complicated shape and an exact description of the *FPS* may be intractable. Therefore, it is a common practice to restrict the exact *FPS* to a more simpler domain such as ellipsoids, orthotopes, axis-aligned orthotopes (or boxes).

Such approach for calculating bounds for the *FPS* has been investigated in several works with : ellipsoid representation [27], [31], [55], exact description [47], [51], [73], [74], bounding parallelotope [25], [26], [72], inner boxes [52], [1], [63], outer bounding orthotopes [17].

The developed algorithms are based on some desirable properties:

- they involve a minimal number of assumptions in respect to the distribution of the measurement errors or the model errors ; indeed there are no need to fix a particular probability density function on the measurement errors.

- the approach may be used for model validation and thus for diagnosis purpose. For a particular set of measurements, if the computed bounds for the parameters become the null set, then the data are not compatible with the model.

- there is a possibility to appreciate globally the uncertainty of the parameters. When uncertainties affecting parameters are small, then the volume of the solution set will be also small.

- the true parameters are contained in the *FPS* and thus are within the computed bounds (this is important in the non linear case where classical approach do not always guarantees obtaining the global optimal estimate).

Example 1. A linear regression.

Let us consider the data of table 1, with $N = 3$ and $m = 2$. The underlying model is $y(k) = x_1(k)\theta_1 + x_2(k)\theta_2$ and thus the problem to solve is the estimation of $\theta = (\theta_1 \ \theta_2)$ using the three given measurements. In the plan (θ_1, θ_2) the following straight lines may be drawn ($x_2(k)$ is supposed to be non zero):

$$\Delta_k^- : \theta_2 = (y_m(k) - \delta - x_1(k)\theta_1)/x_2(k) \quad (10a)$$

$$\Delta_k^+ : \theta_2 = (y_m(k) + \delta - x_2(k)\theta_1)/x_2(k) \quad (10b)$$

k	$y_m(k)$	$x_1(k)$	$x_2(k)$
1	2.5	1.1	0.1
2	1.8	0.2	1.2
3	3.4	1.3	0.8

Table 1: Measurements

for $k = 1..3$ and using measurements gathered in table 1. Three cases have been considered according to possible values of the measurement error bound δ . The figure 1 relates the situation where $\delta = 0$ and thus it is desired that all the data be compatible with the model (with the assumption of free noise measurement). Indeed, no solution appears for θ_1 and θ_2 since the three lines do not intercept at the same point. We conclude that the data are not compatible with the data unless with taking into account the measurement noise. The symbol o on the figure locates the least square solution satisfying approximately the inequalities (4).

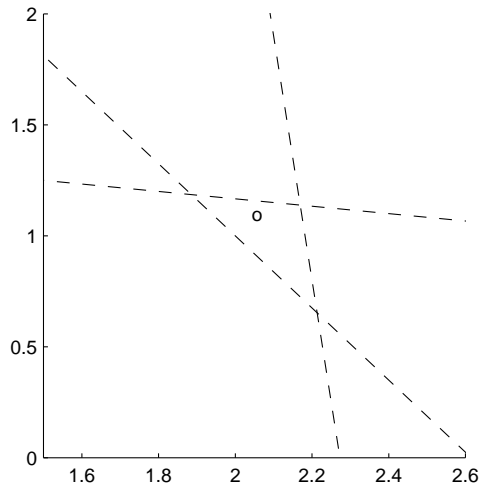

Figure 1: θ domain for the free noise case ($\delta = 0$)

Figures 2 concerns the case $\delta = 0.05$ and no solution exists since $D_3 = \emptyset$. With $\delta = 0.18$, figure 3 shows the set of admissible solutions. Thus, the given model and the measurement errors are compatible with the data only when a sufficient magnitude of the errors is used. It should be notice that the shape of the domain containing the parameter solutions needs three inequalities in order to be described:

$$2.68 - 1.1\theta_1 - 0.1\theta_2 \leq 0 \quad (11a)$$

$$1.98 - 0.2\theta_1 - 1.2\theta_2 \leq 0 \quad (11b)$$

$$3.22 - 1.3\theta_1 - 0.8\theta_2 \geq 0 \quad (11c)$$

which is not a very convenient way to define the admissible parameter values. For future use, that explains the interest to approximate the true domain by a more simpler description such as a box. For example, the box:

$$\begin{cases} 2.02 \leq \theta_1 \leq 2.08 \\ 1.02 \leq \theta_2 \leq 1.08 \end{cases} \quad (12)$$

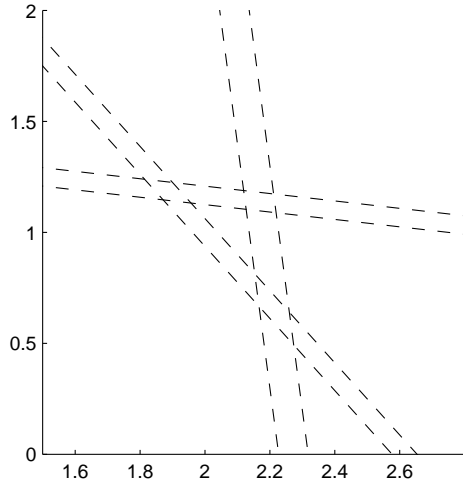

Figure 2: θ domain $\delta = 0.05$

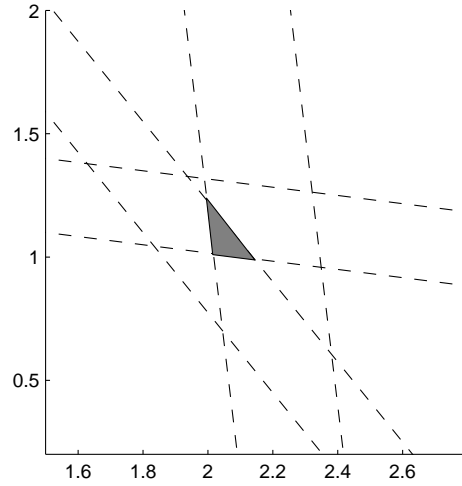

Figure 3: θ domain $\delta = 0.18$

belongs to the domain described by (11) and figure 4 visualises this box and its position in respect to the exact set of solutions. ■

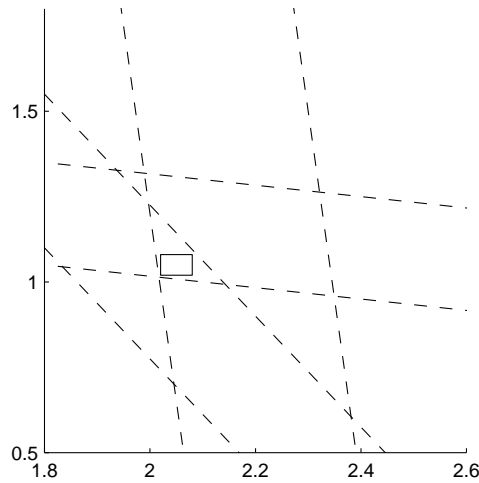

Figure 4: θ approximate domain $\delta = 0.18$

Example 2. Estimation of the offset bounds of a sensor.

Let us consider a sensor with ideal gain equal to unity and with a variable but bounded offset $a(k)$. The problem concerns the estimation of the bounds of this offset using a set of measurement $(x(k), y(k), k = 1..N)$ which are, here, free of noise. The model of the sensor expresses its output y in respect to the variable x to be measured:

$$y(k) = x(k) + a(k) \quad (13)$$

For convenience, the offset $a(k)$ is expressed using the interval form with the center a_c and the

radius δ :

$$a(k) = a_c + \delta\nu(k), \quad \delta > 0 \quad (14a)$$

$$|\nu(k)| \leq 1 \quad (14b)$$

$\nu(k)$ explaining the time variation of the offset value. The bounds $a_c - \delta$, $a_c + \delta$ of the offset have to be consistent with (13). Thus, the measurements are consistent with the sensor model if:

$$|y(k) - x(k) - a_c| \leq \delta, \quad k = 1..N \quad (15)$$

or more explicitly:

$$\begin{cases} y(k) - x(k) - a_c - \delta \leq 0, & k = 1..N \\ -y(k) + x(k) + a_c - \delta \leq 0, & k = 1..N \end{cases} \quad (16)$$

Identifying the bounds δ of the offset consists in solving linear inequalities (16) in respect to a_c and δ . In fact, there are an infinity of solutions due to the fact that increasing δ always make it possible to satisfy the whole set of inequalities (16). Additional constraint may be added and among them it is realistic to exhibit the most precise model, i.e. those characterized with smallest offset range. This may be performed by using classical tools in the field of Linear Matrix Inequality (LMI) by solving the problem in respect to δ and a_c :

$$\min_{\delta, a_c} \delta \quad (17)$$

with respect to the constraints:

$$y(k) - x(k) - a_c - \delta \leq 0, \quad k = 1..N \quad (18a)$$

$$-y(k) + x(k) + a_c - \delta \leq 0, \quad k = 1..N \quad (18b)$$

Since the model description is limited here with two parameters a_c and δ , a geometrical interpretation may be used in the plan (a_c, δ) . Figure 5 shows the set of solutions obtained from inequalities (16). The lines $a_c = -\delta + y(k) - x(k)$ and $a_c = \delta + y(k) - x(k)$ have been drawn to visualize the shape of the domain of solutions (in gray). Moreover, it is easy to express the optimal solution $(\hat{\delta}, \hat{a}_c)$ in the sense of the most precise model, i.e. the model whose parameter a_k has a limited range of variation (marked with the symbol 'o' on the figure). The analytical solution is expressed

$$S : \begin{cases} \hat{a}_c = \frac{1}{2}(\epsilon_{max} + \epsilon_{min}) \\ \hat{\delta} = \frac{1}{2}(\epsilon_{max} - \epsilon_{min}) \\ \epsilon(k) = y(k) - x(k) \\ \epsilon_{min} = \inf_k(\epsilon(k)) \\ \epsilon_{max} = \sup_k(\epsilon(k)) \end{cases} \quad (19)$$

■

3 The linear regression

In order to generalise the representation given by (1), let us consider an uncertain model of a system with several (n) outputs, linear in parameters and observations, and represented by the following structure:

$$\tilde{Y}(k) = \tilde{X}(k)\theta(k) + E(k) \quad k = 1..N \quad (20)$$

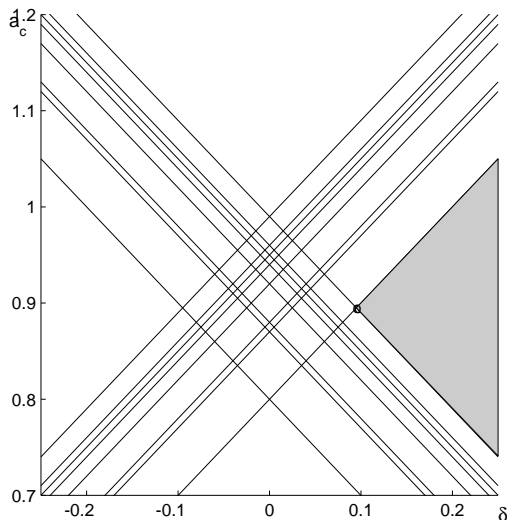

Figure 5: parameter domain in the plan (a_c, δ)

where $\tilde{Y}(k) \in \mathbb{R}^n$, $\tilde{X}(k) \in \mathbb{R}^{n \times p}$ are the known variables at the time k and $\theta(k) \in \mathbb{R}^p$ defines model parameters. The bounded vector $E(k) \in \mathbb{R}^n$ defines the error taking into account the uncertainties due to the measuring process and to modelling errors at the same time. This type of model includes the particular case of MISO systems and that of MIMO systems.

The problem involved with parameter estimation is to characterise the unknown parameters of a model using experimental data $\tilde{X}(k)$ and $\tilde{Y}(k)$. In other words, the aim is to determine the parameter domain containing all possible values consistent with data for bounds E_{min} and E_{max} , such that:

$$\Theta = \{\theta(k) \in \mathbb{R}^p : \tilde{Y}(k) \in \tilde{X}(k)\theta(k) + [E_{min} E_{max}]\} \quad (21)$$

In the case of time varying parameters, an outer-bounding of Θ noted \mathcal{P}_θ , such that \mathcal{P}_θ is a parallelotope which some properties will be described in the following paragraph. Before that, some details about the description of the uncertainties are given.

Additive uncertainties are represented in model (20) by the vector $E(k)$ assumed to belong to the domain noted $\mathcal{P}_E(\delta)$:

$$\mathcal{P}_E(\delta) = \{Z(\delta)u, \|u\|_\infty \leq 1\} \quad (22)$$

with $\delta = (\delta_1 \dots \delta_n)^T$, $u = (u_1 \dots u_n)^T$ and $Z(\delta) \in \mathbb{R}^{n \times n}$. The vector δ defines the magnitude of additive uncertainties which are considered bounded. When these uncertainties affect independently each output, $Z(\delta)$ has the following diagonal structure:

$$Z(\delta) = \begin{pmatrix} \delta_1 & \dots & 0 \\ \vdots & \ddots & \vdots \\ 0 & \dots & \delta_n \end{pmatrix}$$

Multiplicative uncertainties are represented by the parameter vector $\theta(k) \in \mathbb{R}^p$ which fluctuates in an invariant domain denoted $\mathcal{P}_\theta(\lambda, \theta_c)$, defined by:

$$\mathcal{P}_\theta(\lambda, \theta_c) = \{\theta(k) = \theta_c + M(\lambda)\nu(k), \|\nu(k)\|_\infty \leq 1\} \quad (23)$$

The vector $\nu(k)$ is varying inside an unit hypercube noted \mathcal{H}_q ($\mathcal{H}_q = \{\nu \in \mathbb{R}^q / \|\nu\|_\infty \leq 1\}$). It allows to represent the uncertain nature of model parameters. These uncertainties are distributed on the various components of the vector θ via a full row rank matrix $M(\lambda) \in \mathbb{R}^{p \times q}$ (in general $q \geq p$) depending on the vector $\lambda = (\lambda_1 \dots \lambda_q)^T$. In fact, the matrix $M(\lambda)$ defines the volume and the shape of $\mathcal{P}_\theta(\lambda, \theta_c)$. The vector θ_c indicates both the geometrical centre of $\mathcal{P}_\theta(\lambda, \theta_c)$ and the nominal value of the parameter vector. Equation (22), also shows that $\mathcal{P}_\theta(\lambda, \theta_c)$ is the image of the hypercube \mathcal{H}_q under an affine map $\mu_{\theta_c, M(\lambda)}$ defined as:

$$\mu_{\theta_c, M(\lambda)} : \mathbb{R}^q \rightarrow \mathbb{R}^p \quad (24)$$

$$\nu(k) \mapsto \theta(k) = \theta_c + M(\lambda)\nu(k)$$

The domain $\mathcal{P}_\theta(\lambda, \theta_c) = \mu_{\theta_c, M(\lambda)}(\mathcal{H}_q)$ is a parallelotope (called also a zonotope). In the rest of the paper, for sake of simplicity, the matrix $M(\lambda)$ is supposed having the following structure:

$$M(\lambda) = M \text{Diag}(\lambda) \quad (25)$$

According to these definitions of the uncertainties, the parameter estimation problem consists in finding the values of the vectors θ_c , λ and δ which define the parameter domain $\mathcal{P}_\theta(\lambda, \theta_c)$ (22) and the measurement error domain $\mathcal{P}_E(\delta)$ (21), so that the available data $\tilde{Y}(k)$ are compatible with the model (20) in the most precise way:

$$\tilde{Y}(k) \in \mathcal{P}_Y(\lambda, \delta, \theta_c) \quad k = 1..N \quad (26)$$

with (using 20, 22, 23):

$$\begin{aligned} \mathcal{P}_Y(\lambda, \delta, \theta_c) = \{Y(k) \in \mathbb{R}^n : Y(k) = \tilde{X}(k)\theta_c + \tilde{X}(k)M(\lambda)\nu(k) + Z(\delta)u(k), \\ \|u(k)\|_\infty \leq 1, \|\nu(k)\|_\infty \leq 1\} \end{aligned} \quad (27)$$

In other words, $\mathcal{P}_Y(\lambda, \delta, \theta_c)$ defines all possible values of the variables $Y(k)$ consistent with variables $\tilde{X}(k)$ and the model uncertainties description given by the vectors λ and δ . So, $\mathcal{P}_Y(\lambda, \delta, \theta_c)$ is an interval estimation of measurements $\tilde{Y}(k)$. The expression which generates the domain $\mathcal{P}_Y(\lambda, \delta, \theta_c)$, parametrized by λ , δ and θ_c , can also be expressed as:

$$\tilde{Y}(k) \in \mathcal{P}_Y(\lambda, \delta, \theta_c) \Leftrightarrow \tilde{Y}(k) = \tilde{X}(k)\theta_c + T(k, \lambda, \delta)w(k) : w(k) \in \mathcal{H}_{q+n} \quad (28)$$

with:

$$\begin{aligned} T(k, \lambda, \delta) &= (\tilde{X}(k)M(\lambda) \quad Z(\delta)) \\ w(k) &= \begin{pmatrix} \nu(k) \\ u(k) \end{pmatrix} \end{aligned} \quad (29)$$

The matrix $T(k, \lambda, \delta)$, defined in (29), has the form:

$$T(k, \lambda, \delta) = (\lambda_1 t_1(k) \dots \lambda_q t_q(k) \quad \delta_1 e_1 \dots \delta_n e_n) \quad (30)$$

with $t_i(k) = \tilde{X}(k)m_i$, for $i = 1..n$, m_i being the columns of the matrix M , and $I_n = (e_1 \dots e_n)$ being the identity matrix in $\mathbb{R}^{n \times n}$.

Knowing that $w(k)$ varies in \mathcal{H}_{q+n} ($\|w(k)\|_\infty \leq 1$), it is possible to calculate the lower and upper bounds of each component of \tilde{Y} . Indeed, from (28), one obtains:

$$\tilde{Y}(k) \leq \tilde{X}(k)\theta_{c+} + |T(k, \lambda, \delta)| \mathcal{I}_{q+n} \quad (31a)$$

$$\tilde{Y}(k) \geq \tilde{X}(k)\theta_{c-} - |T(k, \lambda, \delta)| \mathcal{I}_{q+n} \quad (31b)$$

where $|\cdot|$ denotes the absolute value operator and \mathcal{I}_{q+n} is a unity vector in \mathbb{R}^{q+n} (all its elements are equal to 1). In order to point out the role played by the parameters δ and λ in (31), let us define:

$$\alpha = \begin{pmatrix} \lambda \\ \delta \end{pmatrix} \quad (32a)$$

$$\tilde{T}(k) = [\tilde{X}(k)m_1 \dots \tilde{X}(k)m_q \ I_n] \quad (32b)$$

Then $\mathcal{P}_Y(\lambda, \delta, \theta_c)$ and $d(k, \lambda, \delta, \theta_c)$ become respectively $\mathcal{P}_Y(\alpha, \theta_c)$ and $d(k, \alpha, \theta_c)$. Using definitions (32), relations (31) become:

$$\tilde{Y}(k) \leq \tilde{X}(k)\theta_{c+} + |\tilde{T}(k)| \alpha \quad (33a)$$

$$\tilde{Y}(k) \geq \tilde{X}(k)\theta_{c-} - |\tilde{T}(k)| \alpha \quad (33b)$$

As a conclusion of the model characterization, we have to estimate the parameters θ_c of the regression, its bounds λ and the bounds δ of the additive errors, using inequalities (33) expressed for the whole set of available observations $\tilde{X}(k)$ and $\tilde{Y}(k)$. Indeed, pilling all the inequalities (33) give the system:

$$\begin{pmatrix} X(1) & | & T(1) & | \\ \dots & & & \\ \tilde{X}(N) & | & T(N) & | \\ -X(1) & | & T(1) & | \\ \dots & & & \\ -\tilde{X}(N) & | & T(N) & | \end{pmatrix} \begin{pmatrix} \theta_c \\ \lambda \\ \delta \end{pmatrix} \geq \begin{pmatrix} Y(1) \\ \dots \\ Y(N) \\ -Y(1) \\ \dots \\ -Y(N) \end{pmatrix} \quad (34)$$

which may be solved, in respect to θ_c , λ , δ using standard linear matrix inequality algorithms.

Example 3. Model structure arrangement.

The following example clarify the structure of the model and its uncertainty. It allows also to express more clearly the identification problem. The model is characterized by two outputs y_i , two varying parameters θ_i , three uncertainties λ_i affecting the parameters and two additive uncertainties:

$$\begin{cases} \tilde{y}_1(k) = \tilde{x}_1(k)\theta_1(k) + \tilde{x}_2(k)\theta_2(k) + e_1(k) \\ \tilde{y}_2(k) = \tilde{x}_1(k)\theta_2(k) + \tilde{x}_3(k)\theta_2(k) + e_1(k) \end{cases} \quad (35)$$

$$\begin{cases} \theta_1(k) = \theta_{c,1} + \lambda_1\nu_1(k) + \lambda_3\nu_3(k) \\ \theta_2(k) = \theta_{c,2} + \lambda_1\nu_1(k) + \lambda_2\nu_2(k) \end{cases} \quad (36)$$

Thus, we have:

$$\begin{cases} \tilde{X}(k) = \begin{pmatrix} \tilde{x}_1(k) & \tilde{x}_2(k) \\ 0 & \tilde{x}_1(k) + \tilde{x}_3(k) \end{pmatrix} \\ M = \begin{pmatrix} 1 & 0 & 1 \\ 1 & 1 & 0 \end{pmatrix} \\ T(k) = \begin{pmatrix} \tilde{x}_1(k) + \tilde{x}_2(k) & \tilde{x}_2(k) & \tilde{x}_1(k) & 1 & 0 \\ \tilde{x}_1(k) + \tilde{x}_3(k) & \tilde{x}_1(k) + \tilde{x}_3(k) & 0 & 0 & 1 \end{pmatrix} \end{cases} \quad (37)$$

These definitions allow to construct and to solve the inequality system (34). ■

4 Observer

The problem of state estimation, in the context of bounded state noise and measurement error, is to characterize the set of all state vectors of a given model that are compatible with the measured inputs and outputs and the assumed errors bounds. Because of uncertainty and noise influence, it is not possible to estimate the state exactly. However, it seems reasonable to estimate a domain in which the real state of the system is contained. In the scientific literature, the problem is addressed as the set-valued state estimation [41], [53], [69], [73], [74]. The basic formulation of such observer may be summarized as follows. Consider a dynamical system:

$$S : \begin{cases} x(k+1) = f(x(k), u(k), v(k)), & x(0) = x_0 \\ y(k) = h(x(k)) + w(k) \end{cases} \quad (38)$$

where the state $x \in \mathbb{R}^n$, $y \in \mathbb{R}^p$ is the output or observation of the state and v and w are bounded disturbances or uncertainties. Given bounds on the uncertainties, we want to estimate the bounds (x^-, x^+) of the state. The evaluation of the interval $[x^- \ x^+]$ will be done by means of a worst-case observation. At time $k+1$, it consists in computing a confidence domain $D_{x,k+1}$ for system state based on the confidence domain of the uncertainties v and w . With a recursive point of view, $D_{x,k+1}$ will be constructed by using the successive process confidence domains $D_{x,k} \dots D_{x,0}$.

In order to obtain a guaranteed state estimator, we need a priori bounds of uncertainties v and w . Then, the set of states has to be compatible or consistent with these a priori bounds and the current measurements [41], [21], [69]. For non-linear systems, it is difficult to get an explicit equation defining the bounds of the estimate; however it is easy to define an ideal algorithm that constructs progressively the set of possible states $D_{x,k}$ which is consistent with the current trajectory and the uncertainty bounds. For linear system, the situation is more simpler, since the set of possible states may take the form of polytope. Thus, the following subsections present the general idea for set-valued observer, a particular situation where the bounds can be described with an explicit expression and, finally, the case of linear systems.

4.1 Ideal interval observer

The initial state x_0 of system (38) is assumed to belong to some prior compact set $D_0 \subset \mathbb{R}^n$. The unknown state and measurement noises are bounded and for sake of simplicity their bounds are time constant:

$$|v(k)| \leq \delta_v, \quad |w(k)| \leq \delta_w \quad (39)$$

At time k , let $\mathcal{D}_{x,k}$ the set containing the values of $x(k)$ compatible with the available informations $\{D_0, \{u(i), y(i), |v(i)| \leq \delta_v, |w(i)| \leq \delta_w\}_{i=0}^k\}$ and the model (38). Let us also define $\mathcal{D}_{y,k}$ the set of values of the output knowing its measured values $y(k)$:

$$\mathcal{D}_{y,k} = \{y : |y - y(k)| < \delta_y\} \quad (40)$$

At time $k+1$, two informations about the state are available: the prediction $x^+(k)$ of the state using the system model, the measurement $y(k+1)$ which depends on the state $x(k+1)$. Thus we define the two sets:

$$\mathcal{D}_{x,k}^+ = \{f(x, u(k), v(k)) : x \in \mathcal{D}_{x,k}, |v_k| \leq \delta_v\} \quad (41a)$$

$$\mathcal{D}_{x,k}^y = \{x \in \mathbb{R}^n : h(x) \in \mathcal{D}_{y,k}\} \quad (41b)$$

Thus, at time $k+1$, the set $\mathcal{D}_{x,k+1}$ is given by:

$$\mathcal{D}_{x,k+1} = \mathcal{D}_{x,k}^+ \cap \mathcal{D}_{x,k+1}^y \quad (42)$$

Summarizing, as for an observer used for certain system, there are two steps for the state estimation: first, a prediction using the model of the system and the previous estimate, second a correction using the information contained in the output measurement.

Example 4. State prediction of a scalar system.

For example, let us consider the system:

$$x(k+1) = [0.5 \ 0.6]x(k) + 0.5, \quad x_0 \in [0.2 \ 0.3] \quad (43a)$$

$$y(k) = x(k) + w(k) \quad (43b)$$

with the measurement : $y(1) \in [0.55 \ 0.65]$. With $\mathcal{D}_{x,0} = [0.2 \ 0.3]$, the state prediction at time (1) yields:

$$\begin{aligned} \mathcal{D}_{x,0}^+ &= [0.5 \ 0.6][0.2 \ 0.3] + 0.5 \\ &= [0.60 \ 0.68] \end{aligned}$$

Output at time 1 gives the state estimation:

$$\mathcal{D}_{x,1}^y = [0.55 \ 0.65]$$

and thus the correction step leads to:

$$\mathcal{D}_{x,1} = [0.60 \ 0.65] \quad \blacksquare$$

4.2 Analytical description of bounds

The ideal observer defined with (40), (41a) and (42) allows the construction, on a numerical point of view, of the set of estimates. Generally, this is a tedious task, and no analytical expression of the bounds may be exhibited. However, for some specific structures [33], [18], [70], the state observer may be described with a state representation. For that let us define a pair of systems S^- and S^+ :

$$S^- : \begin{cases} z^-(k+1) = g^-(z^-(k), y(k)) \\ x^-(k+1) = \ell^-(z^-(k), z^+(k), y(k)) \end{cases} \quad (44)$$

$$S^+ : \begin{cases} z^+(k+1) = g^+(z^+(k), y(k)) \\ x^+(k+1) = \ell^+(z^-(k), z^+(k), y(k)) \end{cases} \quad (45)$$

where the functions g^- , g^+ , ℓ^- , ℓ^+ have to be defined. Then (S^-, S^+) is an interval estimator for system S , if for any compact set $\mathcal{X}_0 \subset \mathbb{R}^m$ there exists initial conditions $(z^-(0), z^+(0))$ such that the system (S, S^-, S^+) verify for any initial condition $x(0) \in \mathcal{X}_0$ [33], [60]:

$$x^-(k) \leq x(k) \leq x^+(k) \quad (46)$$

where the operator \leq applied to vector understanding as inequalities applied to their components. Equations (44) and (45) allows to compute two estimates x^- and x^+ that bound the unknown state of the system. Of course we are looking for the best estimate, i.e. the interval $[x^-(k) \ x^+(k)]$ has to be as small as possible at each time instant. As a particular case, let us examine the conception of this interval observer for the system described by:

$$S : \begin{cases} x(k+1) = Ax(k) + f(y(k), v(k)) \\ y(k) = Cx(k) \end{cases} \quad (47)$$

where the function f has bounds f^- and f^+ :

$$f^-(y) \leq f(y, v) \leq f^+(y)$$

The interval observer is written:

$$S^\mp : \begin{cases} x^-(k+1) = Ax^-(k) + f^-(y(k)) + L(y(k) - Cx^-(k)) \\ x^+(k+1) = Ax^+(k) + f^+(y(k)) + L(y(k) - Cx^+(k)) \end{cases} \quad (48)$$

The matrix L must be adjusted in order that (46) will be satisfied. The estimation error is defined using the two bounds:

$$e^-(k) = x(k) - x^-(k) \quad (49a)$$

$$e^+(k) = x^+(k) - x(k) \quad (49b)$$

With definitions (47) and (48), derivative according to time leads to:

$$e^+(k+1) = (A - LC)e^+(k) + f^+(y) - f(y) \quad (50)$$

Lemma 1 : the system $x(k+1) = f(x(k))$ is cooperative if $\frac{\partial f_i}{\partial x_j} \geq 0$, $\forall i, \forall j$. It implies that if $x(0) \geq 0$, then $x(k) \geq 0$, $\forall k \geq 0$.

Noticing that $f^+ - f \geq 0$, if it is possible to adjust the gain L of the observer such that $(A - LC)$ is cooperative; then $e^+(0) \geq 0$ implies $e^+(k) \geq 0$ all along the time. Similar conclusion may be obtained for $e^-(k)$.

4.3 The linear case

Let us consider the simple case of the scalar equation:

$$x(k+1) = a(k)x(k), \quad x(0) \in [x_0^-, x_0^+], \quad a(k) \in [a^-, a^+] \quad (51a)$$

$$y(k) = c(k)x(k), \quad c(k) \in [c^-, c^+] \quad (51b)$$

According to the arithmetic operators, the bounds of the state x may be constructed. If $[a]$ is positive:

$$\begin{cases} x^-(k+1) &= \frac{1}{2}x^-(k)((a^- + a^+) - (a^+ - a^-)\text{sgn}(x^-(k))) \\ x^+(k+1) &= \frac{1}{2}x^+(k)((a^- + a^+) + (a^+ - a^-)\text{sgn}(x^+(k))) \end{cases}$$

If $[a]$ is negative:

$$\begin{cases} x^-(k+1) &= \frac{1}{2}x^+(k)((a^- + a^+) - (a^+ - a^-)\text{sgn}(x^+(k))) \\ x^+(k+1) &= \frac{1}{2}x^-(k)((a^- + a^+) + (a^+ - a^-)\text{sgn}(x^-(k))) \end{cases}$$

Summarizing the two situations, we obtain:

$$\begin{cases} x^-(k+1) = \frac{1}{2}(x^-(k)(m_a - \delta_a \text{sgn}(x^-(k))(1 + \text{sgn}(a)) + x^+(k)(m_a - \delta_a \text{sgn}(x^+(k))(1 - \text{sgn}(a)))) \\ x^+(k+1) = \frac{1}{2}(x^+(k)(m_a + \delta_a \text{sgn}(x^+(k))(1 + \text{sgn}(a)) + x^-(k)(m_a + \delta_a \text{sgn}(x^-(k))(1 - \text{sgn}(a)))) \end{cases} \quad (52)$$

with the definitions:

$$\begin{cases} 2\delta_a &= a^+ - a^- \\ 2m_a &= a^+ + a^- \end{cases}$$

Thus (52) allows the computation of the bounds of the state. As explained in section 4.1, the construction of an observer may be achieved by combining the prediction given by the previous state equation and the observation of the state expression given by the output equation.

We consider now the more general case of a linear uncertain model with n states:

$$x(k+1) = A_k x(k) + Bu(k) \quad (53a)$$

$$y(k) = Cx(k) \quad (53b)$$

where the state matrix is expressed:

$$A_k = A + \Delta_k \quad (54a)$$

$$\Delta_k = (\delta_{ij}(k))_{i,j=1:n}, \quad |\delta_{ij}(k)| \leq \delta_{ij}, \quad \Delta = (\delta_{ij})_{i,j=1:n} \quad (54b)$$

For sake of simplicity, B is supposed to be constant, but extension to an interval matrix is straightforward. Using state equation (53) and definition (54), direct calculation of product and sum of intervals leads to the following expression for the lower bound $x^-(k)$ and upper bound $x^+(k)$ of the state [24]:

$$\begin{pmatrix} x^-(k+1) \\ x^+(k+1) \end{pmatrix} = M \begin{pmatrix} x^-(k) \\ x^+(k) \end{pmatrix} + N \begin{pmatrix} |x^-(k)| \\ |x^+(k)| \end{pmatrix} + Eu(k) \quad (55)$$

with the definitions:

$$M = \frac{1}{2} \begin{pmatrix} A+ |A| & A- |A| \\ A- |A| & A+ |A| \end{pmatrix} \quad (56a)$$

$$N = \frac{1}{2} \begin{pmatrix} -\Delta - \Delta \otimes S_A & -\Delta + \Delta \otimes S_A \\ \Delta - \Delta \otimes S_A & \Delta + \Delta \otimes S_A \end{pmatrix} \quad (56b)$$

$$S_A = \text{sgn}(A), \quad E = \begin{pmatrix} B \\ B \end{pmatrix} \quad (56c)$$

As explained in section 4.1, the state obtained with (55) may be compared with those deduced from the measurement equation (53).

Example 5. A second order system.

The system (53) has been simulated with the following definition:

$$A = \begin{pmatrix} 0.5 & -0.1 \\ -0.1 & 0.75 \end{pmatrix} \quad B = \begin{pmatrix} 0.4 & 0 \\ 0.01 & 0.4 \end{pmatrix} \quad \Delta = \begin{pmatrix} 0.02 & 0.01 \\ 0.01 & 0.02 \end{pmatrix}$$

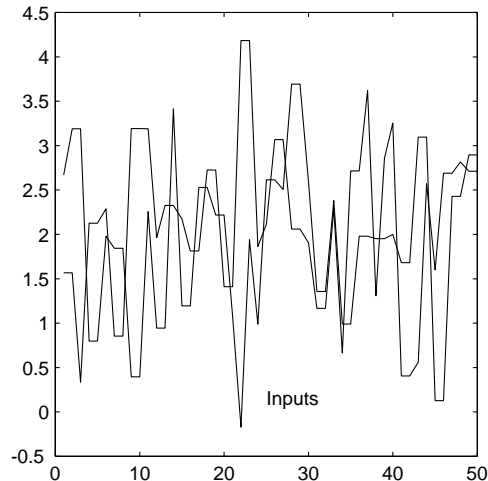

Figure 6: Inputs

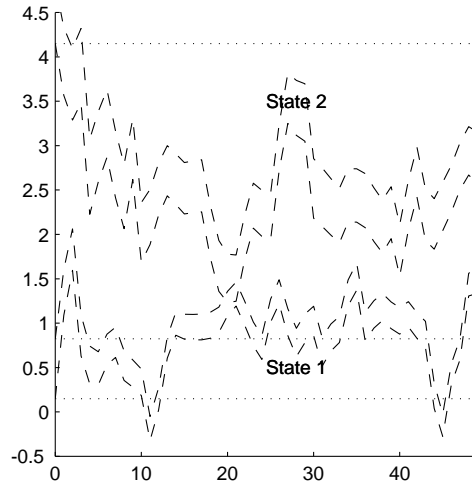

Figure 7: State interval

Figure (6) and (7) respectively show the inputs and the state interval of the system. ■

4.4 Worst-case observation

Uncertain linear systems, as (53), are characterized by parameters whose time evolution is not a priori known; however, the range of variation of these parameters may be known. Thus the state estimation has to take into account that the uncertain parameters are varying at each time step. On the contrary, with a time-invariant approach, the uncertain parameters are supposed unknown, constant and bounded. Here, we are involved with the case of time varying parameters. The best way to take account of these variations is to express the state at time k in respect to the initial state at time 0 and after to analyse the influence of the uncertainties on the whole

state trajectory:

$$x(k) = A(\eta(k-1)) \dots A(\eta(0))x(0) + B(\eta(k-1))u(k-1) + \sum_{i=1}^{k-1} A(\eta(k-1)) \dots A(\eta(i))B(\eta(i-1))u(i-1)$$

where $|\eta(i)| \leq 1, i = 1, \dots, k-1$. At any time instant k , the system state domain $\mathcal{D}_{x,k}$ will be bounded by its interval hull $\square S$:

$$\square S_{x,k} = [x^-(k), x^+(k)] \quad (57)$$

where:

$$\begin{cases} x^+(k) = \max_{\eta} x(k) \\ x^-(k) = \min_{\eta} x(k) \end{cases} \quad (58)$$

with $\eta = (\eta(0) \dots \eta(k-1))$. This approach allows to determine the worst-case simulation with the only conservatism due to the fact that optimization for the bounds are achieved independently although there are common uncertainties between the components of x . A main drawback of the proposed procedure is the dimension of the optimization problems, since $x(k)$ is a polynomial which degree increases with time k . That is the reason why one can suggest to estimate the bounds on the state using a sliding window of length $L+1$. Indeed, the state at time $k+L$ is expressed in respect to the initial conditions at time k according to:

$$x(k+L) = A(\eta(k+L-1)) \dots A(\eta(0))x(k) + B(\eta(k+L-1))u(k-1) + \sum_{i=1}^{k-1} A(\eta(k+L-1)) \dots A(\eta(i))B(\eta(i-1))u(i-1), \quad \|\eta(\cdot)\|_{\infty} \leq 1 \quad (59)$$

The interval hull has been already defined with (57) for the window $[0 k]$. Now the window $[k k+L]$ is considered, but the number of parameters η is constant when the window is moving. A more simpler solution consists in using an "almost time invariant" approach. For that purpose one supposes a constant value for the uncertainty inside the time window:

$$x(k+L) = A^L(\eta)x(L) + \sum_{i=1}^k A^{k-1-L}(\eta)B(\eta)u(i-1) \quad (60)$$

and thus the number of uncertainties is fixed and does not depend on the size of the sliding window. The main problem is to determine the size of the window and some results on that subject are given in [59].

4.5 Application to diagnosis

In the previous section, the structure of the interval observer is based both on the state equation which gives a prediction of the state and on the measurements used to correct the prediction. When applying the strategy, it is assumed that measurements are free of fault, otherless the correction step may be incompatible with the prediction step. In fact, for diagnosis, the objective does not concern the state estimation but the fault detection and isolation. Thus, we need to

generate residual or indicator sensitive to the fault. One way to perform that is to compare the measured output and its prediction thanks to the model, both outputs being intervals. The set $\mathcal{D}_{y,k}^+$ of the predicted output is only deduced from the set $\mathcal{D}_{x,k}^+$:

$$D_{y,k}^+ = \{y = h(x^+) + w(k+1) : x^+ = f(x, u(k), v(k)), x \in \mathcal{D}_{x,k}, : v(k) \leq \delta_v, |w(k)| \leq \delta_w\} \quad (61)$$

In order to take into account the uncertainties associated to the measuring procedure, the set of values of the output knowing its measured value $y(k)$ has been already defined in (40). Consequently, an interval residual may be defined as follows:

$$r_{k+1} = \mathcal{D}_{y,k}^+ \cap \mathcal{D}_{y,k+1} \quad (62)$$

A fault is detected if $r_{k+1} = \emptyset$. It should be noticed that at each time, we have to compute limits of two domains which usually needs a important effort. For that reason, it is often preferable to use approximate bounds. For example, considering (62), let us define the modified residual:

$$r_{k+1} = \mathcal{D}_{yex,k}^+ \cap \mathcal{D}_{y,k+1} \quad (63)$$

$D_{yex,k}^+$ being an external estimate of $D_{y,k}^+$, i.e.:

$$D_{y,k}^+ \subseteq D_{yex,k}^+ \quad (64)$$

If $D_{yex,k}^+$ is much easier to obtain than $D_{y,k}^+$, then residual (63) is easier to compute than (62); however $D_{yex,k}^+$ detects less faults than $D_{y,k}^+$. Indeed, if $D_{yex,k}^+ \cap \mathcal{D}_{y,k+1} \neq \emptyset$ and $D_{y,k}^+ \cap \mathcal{D}_{y,k+1} = \emptyset$, then a fault has occurred but is not detected [12].

5 Data validation: steady state system

The problem of obtaining reliable estimates of the state of a process is a fundamental objective in process control and supervision, these estimates being used to understand the process behaviour. For that purpose, a wide variety of techniques has been developed to perform what is currently known as data reconciliation. Data reconciliation, which is sometimes referred too as mass and energy balance equilibration, is the adjustment of a set of data so the quantities derived from the data obey physical laws such as material and energy conservation.

The structural information in a plant can be conveniently represented by a direct graph, the nodes of which represent the process units as reactors, tanks, distillation columns, whilst the arcs represent streams of circulating matter. The mathematical model originated from mass conservation laws and assuming linear relationships, is written under the exact structural form:

$$Mx = 0 \quad (65)$$

where $M \in \mathbb{R}^{n.v}$ is the incidence matrix of the process graph with n the number of nodes and v the number of arcs, $x \in \mathbb{R}^v$ is the vector of "true" values (unreachable to the measure).

Classical approaches for data validation use the assumption of an underlying normal distribution for the measurement error. This is not very realistic and can be criticized in regard to the fact that it extends to infinity. In the common practice, the probability of variation of more than five standard deviations is very small and enough to be considered as negligible. Moreover, for

a value around zero, a significant probability of a negative value could occur against all physical sense. Thus, the use of a log-normal distribution or other adapted distribution could avoid this kind of difficulty. That may justify an approach for data reconciliation which does not assume the hypothesis of normal distribution. There is a few work published in this area. In [35], the use of bounds for the estimation with an interval formulation is called to mind and developed on a example. More recently, in [43] and [61] the using of LMI approach (Linear Matrix Inequality) allows to formulate more generally the bounded estimation problem and an admissible solution is proposed.

According to the precision of the measurement devices, the available measurement \tilde{x} are expressed as intervals:

$$x^- \leq \tilde{x} \leq x^+ \quad (66)$$

where x^- and x^+ are respectively the upper and lower bounds of process variables. Indeed, a measurement \tilde{x} is represented by an interval $[x^- \ x^+]$ whose length is directly related to the measurement precision.

Considering now the model (65) and the measurement (66), it is desired to give an estimation \hat{x} of the flowrates. The proposed strategy consists of two steps. First, taking into account the model constraint (65), we reduce the number of variables to be estimated. Second, we choose to express the estimations of the true values with an interval representation.

First step: data reduction

As the different equations of the model (represented by the rows of the matrix M) are independent, the matrix M has full row rank. Therefore, the following partition always holds:

$$M = (M_b \quad M_h) \quad (67)$$

with M_b being a $n.n$ regular matrix. That allows to express the model (65) as:

$$x = Ax_b, \quad x_b \in R^{v-n} \quad (68a)$$

$$A = \begin{pmatrix} H \\ I \end{pmatrix} \quad (68b)$$

$$H = -M_b^{-1}M_h \quad (68c)$$

In other words, the process was initially described by v variables; however redundancy expressed by the model of the process allows to reduce the number of variables to $v - n$. Therefore reconciliation will be performed using only a subset of variables.

Second step: interval estimation

According to the previous decomposition, the state x has to be estimated taking into account the measurement intervals (66). As explain with the example of section 2, the estimate is chosen to belong to a box described by:

$$\hat{x}_b = x_c + \lambda \otimes x_r \quad x_c \in R^{v-n} \quad x_r \in R^{v-n} \quad \lambda \in R^{v-n} \quad (69a)$$

$$\|\lambda\|_\infty \leq 1 \quad (69b)$$

where the operator \otimes performs element-by-element product of two vectors. Indeed, the estimation \hat{x}_b is chosen as a box, the center of which being x_c , the width being $2x_r$. In definition (69a), the variable λ allows to consider all the values inside the box and consequently, for the state estimation problem, we consider a set of admissible solutions. Gathering equations (66), (68a) and (69a) gives:

$$x^- \leq A(x_c + \lambda \otimes x_r) \leq x^+ \quad (70a)$$

$$\|\lambda\|_\infty \leq 1 \quad (70b)$$

Then (70a) has to be solved in respect to the center x_c and the radius x_r ; moreover we suggest to maximise the "size" of the box characterized by the components $x_{r,i}$ of x_r , for example its volume. Then, we have to solve the optimisation problem:

$$\left. \begin{array}{l} \max_{x_c, x_r} \prod_{i=1}^{v-n} x_{r,i} \\ Ax_c + |A| x_r - x^+ \leq 0 \\ -Ax_c + |A| x_r + x^- \leq 0 \end{array} \right\} \quad (71)$$

This classical problem may be solved by using constraint optimization techniques, see for example [19].

Example 6. Mass balance reconciliation.

Figure 8 shows the flowsheet of the process used for data validation. There are a total of fifteen streams with eight unit operations: all the flowrates are measured, otherwise, when measurement are missing, preliminary decomposition and variable classification have to be performed. The method described in the previous section is applied to this flowsheet with data obtained by simulation.

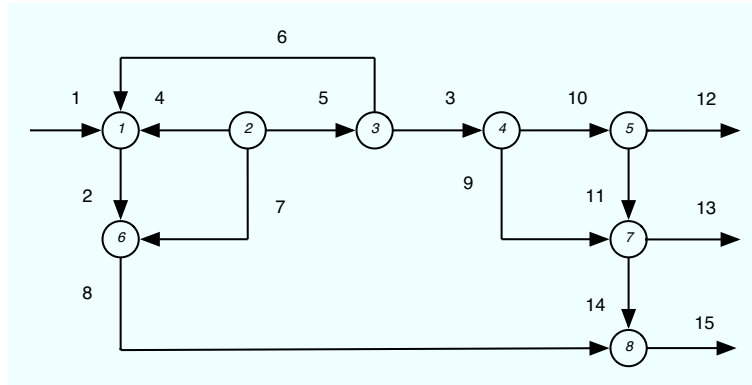

Figure 8: Flowsheet

In table 2, columns 2 and 3 contain the bounds x^- and x^+ of the measurements from which one can also evaluate the center x_c and the radius x_r . Before data reconciliation, a preliminary test may be performed in order to appreciate the coherence of the measurements. For that, interval mass balance residuals are computed according to the formula $[r] = M[x]$. Numerical computation shows that all the interval residuals contain the value 0. Thus, no gross error affect

the measurements and that allows to reconcile the measurements. Analysing results shows that the widths of the estimates are smaller than those of the measurements; this interval reduction is explained by the model constraints which allow to better estimate the true data. This approach may be extended to systems where only a part of the variables are measured. ■

flow	x^-	x^+	\hat{x}^-	\hat{x}^+
1	42.9	50.9	44.718	45.718
2	6.1	13.8	8.1	9.1
3	23.9	27	25.218	26.218
4	40	48	42.809	43.809
5	28.1	40.2	31.909	32.909
6	4.2	8.2	6.191	7.191
7	8.9	12.9	11.4	11.4
8	16	24	19	20
9	8.2	12.2	9.527	10.527
10	14.7	18.7	15.191	16.191
11	4	8	4.836	5.836
12	8.7	12.7	9.855	10.855
13	11.2	14	12.2	13.2
14	1.5	4.5	2.164	3.164
15	18	29	21.664	22.664

Table 2: Measurements and reconciled data

6 Data reconciliation: dynamic system

We consider now the class of dynamic systems represented by linear discrete state equation. The uncertainties are described by bounded and normalized variables, which modify the values of the coefficients of matrices A , B and C all along the time. The system is described by the following model:

$$x(k+1) = A(\eta(k))x(k) + B(\eta(k))u(k) \quad (72a)$$

$$y(k) = C(\eta(k))x(k) \quad (72b)$$

where $x \in \mathbb{R}^n$ is the state vector, $u \in \mathbb{R}^q$ the vector of inputs and $y \in \mathbb{R}^m$ the vector of the output $\eta(k)$ are bounded and normalized variables.

First, considering the observation window $[k, k + s]$, let us define the matrices:

$$\overline{A}(\eta(k, s)) = \begin{pmatrix} A(\eta(k)) & -I & \dots & 0 & 0 \\ 0 & A(\eta(k+1)) & \dots & 0 & 0 \\ \dots & & & & \\ 0 & 0 & \dots & A(\eta(k+s+1)) & -I \end{pmatrix} \in \mathbb{R}^{s.n \times (s+1).n} \quad (73a)$$

$$\overline{B}(\eta(k, s)) = \begin{pmatrix} -B(\eta(k)) & 0 & \dots & 0 \\ 0 & -B(\eta(k+1)) & \dots & 0 \\ \dots & & & \\ 0 & 0 & \dots & -B(\eta(k+s+1)) \end{pmatrix} \in \mathbb{R}^{s.n \times s.q} \quad (73b)$$

$$\overline{C}(\eta(k, s)) = \begin{pmatrix} C(\eta(k)) & 0 & 0 \\ 0 & \dots & 0 \\ 0 & 0 & C(\eta(k+s)) \end{pmatrix} \in \mathbb{R}^{m.(s+1) \times n.(s+1)} \quad (73c)$$

and the vectors:

$$x(k, s) = (x^T(k) \dots x^T(k+s))^T \in R^{(s+1).n} \quad (74a)$$

$$y(k, s) = (y^T(k) \dots y^T(k+s))^T \in R^{(s+1).m} \quad (74b)$$

$$u(k, s) = (u^T(k) \dots u^T(k+s-1))^T \in R^{s.q} \quad (74c)$$

By aggregation of the state equations on the window $[k, k + s]$, we represent the model in the following static form:

$$M(\eta(k, s))x(k, s) = h(\eta(k, s)) \quad (75)$$

$$M(\eta(k, s)) = \begin{pmatrix} \overline{A}(\eta(k, s)) \\ \overline{C}(\eta(k, s)) \end{pmatrix} \quad h(\eta(k, s)) = \begin{pmatrix} \overline{B}(\eta(k, s)) & 0 \\ 0 & I \end{pmatrix} \begin{pmatrix} u(k, s) \\ y(k, s) \end{pmatrix} \quad (76)$$

There are several methods to calculate, by using equation (73) an estimate of $x(k, s)$ [49]. Unfortunately no method can be considered in general better than the others. However, the widths of the interval estimation can constitute an evaluation criterion. Mainly, three methods can be adapted to the model of the considered system: Gauss elimination, Gauss-Seidel iteration, Krawczyk iteration [8]. Thus (75) is a linear interval system, but with generally more equations than unknown variables $x(k, s)$ (see indicated dimensions). Based on algorithm allowing the resolution of square linear interval system (see appendix B) [6] proposes the following strategy:

- Step 1: choose the first rows of $[M]$ in order to form a regular matrix $[M^1]$; $[h^1]$ denotes the corresponding subvector extracted from $[h]$. The subsystem $[M^1] = [h^1]x$ is then solved in respect to the state x and the solution is noted $\hat{x}^1(k, s)$.
- Step 2: choose a second square matrix $[M^2]$ by replacing the last row of $[M^1]$ by the first row in $[M]$ which has not been selected. The same modification is achieved for generating $[h^2]$ from $[h^1]$. The solution of system $[M^2] = [h^2]x$ is noted $x^2(k, s)$. This step is repeated by generating successive interval subsystems $[M^i] = [h^i]x$ whose solutions are noted $x^i(k, s)$; q estimates are thus obtained.

- Step 3: to have an estimation with the finest possible bounds, the final estimation of $x(k, s)$ is calculated by:

$$[\hat{x}(k, s)] = \bigcap_{i=1}^q [x^i(k, s)]$$

7 Conclusion

The paper presents some works about the application of interval analysis applied to state estimation and data validation. Thanks to the characteristics of intervals, interval computations open a wide variety of new opportunities in many fields in process analysis such as modelisation, parameter estimation, state estimation, control, data validation and diagnosis. Interval approach allows to handle the uncertainty in data and model; moreover, real problems may be solved for obtaining validated solutions with guaranteed confidence.

References

- [1] Adrot O., Ploix S. and Ragot J. Détection de défauts appliquée à des modèles statistiques affectés par des incertitudes structurées. GRETSI, Vanves, France, 13 septembre 1999.
- [2] Adrot O., Maquin D. and Ragot J. Diagnosis of an uncertain static system. 39th IEEE Conference on Decision and Control, Darling Harbour, Australia, December 12-15, 2000.
- [3] Adrot O. and Flaus J.M. Fault detection of uncertain dynamic systems. Complex Systems, Intelligence and Modern Technology Applications CSIMTA, Cherbourg, France, 2004.
- [4] Akpan E. Robust observer for uncertain linear systems, American Control Conference, Arlington, V.A., USA, Vol. 6, pp. 4220-4221, 2001.
- [5] Alhaj-Dibo M., Maquin D. and Ragot J. Data reconciliation using interval analysis. 5ème Congrès International Pluridisciplinaire Qualité et Sécurité de Fonctionnement, Qualita 2003, Nancy, France, 18-20 mars 2003.
- [6] Alhaj-Dibo M., Maquin D. and Ragot J. Réconciliation de données par estimation d'état en utilisant l'approche bornante. Système d'Information, Modélisation, Optimisation, Contrôle, Commande en génie des procédés, SIMO'2002, Toulouse, France, 24-25 octobre 2002.
- [7] Alhaj-Dibo M., Maquin D. and Ragot J. Validation de données de modèles dynamiques incertains en utilisant l'approche bornante. Journées Doctorales d'Automatique, Valenciennes, France, 25-27 juin 2003.
- [8] Alhaj-Dibo M., Maquin D. and Ragot J. Data validation of uncertain dynamic systems. 15th International Workshop on Principles of Diagnosis, Carcassonne, France, June 23-25, 2004.
- [9] Alhaj-Dibo M., Maquin D. and Ragot J. Data reconciliation: a robust approach using contaminated distribution. Application in mineral processing for multicomponent products.

- 11th IFAC Symposium on Automation in Mining, Mineral and Metal processing, MMM 2004, Nancy, France, September 8-10, 2004.
- [10] Alhaj-Dibo M., Maquin D. and Ragot J. Validation de données des systèmes dynamiques incertains. Conférence Internationale Francophone d'Automatique, CIFA'2004, Douz, Tunisie, 22-24 novembre 2004.
 - [11] Armengol J., Trave-Massuyes L., Vehi J., Luis de la Rosa J. A survey on interval model simulators and their properties related to fault detection. 14th World Congress of IFAC, Beijing, Chine, Vol. O, pp. 511-519, 1999.
 - [12] Armengol J., Vehi J., Trave-Massuyes L. and Sainz M.A. 4th Symposium on Fault Detection Supervision and Safety for Technical Processes, Safeprocess'2000, Budapest, Hungary, pp. 168-173, 2000.
 - [13] Armengol J., Vehi J., Trave-Massuyes L. and Sainz M.A. 9th GAMM-IMACS International Symposium on Scientific Computing, Computer Arithmetic and Validated Numerics, SCAN'2000, Karlsruhe, Germany, September 19-20, 2000.
 - [14] Armengol J., Vehi J., Sainz M., Herrero P. Fault detection in a pilot plant using interval models and multiple sliding time window. 5th IFAC Symposium on Fault Detection, Supervision and Safety for Technical Processes, Safeprocess'2003, pp. 162, 2003.
 - [15] Armengol J., Vehi J., Sainz M., Herrero P. Application of interval models to the detection of faults in industrial processes. World Automation Congress 2004, WAC 2004, June 28, 2004.
 - [16] Aschemann H., Rauh A., Kletting M., Hofer E. P., Gennat M., Tibken B. Interval Analysis and Nonlinear Control of Wastewater Plants with Parameter Uncertainty, IFAC World Congress 2005, Prague, Czech Republic.
 - [17] Belforte G., Bona B. and Cerone V. Parameter estimation algorithm for a set-membership description of uncertainty. *Automatica*, 26 (5), pp. 887-898, 1990.
 - [18] Bernard O. and Gouzé J.L. Interval observers bundle for a class of bioprocess models. 2nd IFAC Symposium on System Structure and Control, SSSC'04, Oaxaca, Mexico, December 8-10, 2000.
 - [19] Bonnan, J.F., Gilbert J.C., Lemaréchal C., Sagastizábal C.A. Numerical Optimization Theoretical and Practical Aspect, 423 p., Springer, 2003.
 - [20] Boukhris A., Mandel D., Ragot J. Data validation using interval algebra. IEE International Conference on Control, Control'98, Swansea, United Kingdom, September 1-4, 1998.
 - [21] Bouron P., Meizel D., Bonnifait Ph. Set-Membership Non-Linear Observers with Application to Vehicle Localisation. 6th European Control Conference, ECC01, Porto, Portugal, September 4-7, 2001.

- [22] Calderón-Espinoza G., Joaquim Armengol J., Vehí J. Dynamical diagnosis with interval analytical redundancy relations. Working Notes W19: MBS, IJCAI-05 Workshop on Model-Based Systems, July 30, 2005.
- [23] Chang I.C., Yu C., Liou C.T.J. Model-based approach for fault diagnosis. Part 2, extension to interval systems. *Industrial Engineering Chemical Research*, 34, pp. 828-844, 1995.
- [24] Cherrier E., Boutayeb M. Ragot J. Evaluation des bornes d'un système incertain; approche intervalle. *Journal Européen des Systèmes Automatisés*, 37 (9), pp. 1181-1192, 2003.
- [25] Chisci L., Garulli A., Zappa G. Recursive state bounding by parallelotopes. *Automatica*, 32 (7), pp. 1049-1055, 1996.
- [26] Chisci L., Garulli A., Vicino A., Zappa G. Block recursive parallelotopic bounding in set membership identification, *Automatica*, 34 (1), pp. 15-22, 1998.
- [27] Clement T. and Gentil S. Reformulation of parameter identification with unknown-but-bounded errors. *Mathematics and Computers in Simulation*, 30 (3), pp. 257-270, 1988.
- [28] Cuguelero P., Puig V., Saludes J. and Escobet T. A class of uncertain linear interval models for which a set based robust simulation can be reduced to few pointwise simulations. 41st Conference on Decision and Control, Las Vegas, USA, pp. 1862-1863, December 10-19, 2002.
- [29] El Hadji A. and Bonnifait P. Fusion de données redondantes avec une technique ensembliste atteignant la consistance globale. Conférence Internationale Francophone d'Automatique, CIFA 2004, 22 - 24 novembre 2004, Douz, Tunisie.
- [30] Fagarasan I., Ploix S. et al. Bounding approach for fault detection and diagnosis. 9th IFAC Symposium Large Scale Systems, Bucharest, Romania, July 18-20, 2001.
- [31] Fogel E., Huang Y. F. On the value of information in system identification-bounded noise case. *Automatica*, 18, pp. 229-238, 1982.
- [32] Fruchard M., Bernard O. and J.-L. Gouzé. Interval observers with confidence levels. Application to the activated sludge process. 15th IFAC World Congress, Barcelona, Spain, July 21-26, 2002.
- [33] Gouzé J. L., Rapaport A. and Hadj-Sadok Z. Interval observers for uncertain biological systems. *Ecological modelling*, 133, pp. 45-56, 2000.
- [34] Harikumar P., Narasimhan S. A method to incorporate bounds in data reconciliation and gross error detection. Part 2: gross error detection strategies. *Computers and Chemical Engineering*, 17 (11), pp. 1121-1128, 1993.
- [35] Himmelblau D.M. Material balance rectification via interval arithmetic. Process Systems Engineering, PSE'95. The use of computers in chemical engineering, *IChemE Symposium Series*, 92, pp. 121-133, 1985.

- [36] Janati-Idrissi H., Adrot O., Ragot J. and Kratz F. Fault detection of uncertain models using polytope projection, 15th IFAC World Congress, Barcelona, Spain, July 21-26, 2002.
- [37] Jaulin L., Walter E. Set inversion via interval analysis for nonlinear bounded-error estimation. *Automatica*, 29 (4), pp. 1053-1064, 1993.
- [38] Kieffer M. and Walter E. Interval analysis for guaranteed nonlinear parameter and state estimation, *Mathematical and Computer Modelling of Dynamic Systems*, 2005, to appear.
- [39] Kletting M., Rauh A., Aschemann H., Hofer E. P. Consistency tests in guaranteed simulation of nonlinear uncertain systems with application to an activated sludge process, SCAN 2004, Journal of Computational and Applied Mathematics, Fukuoka, Japan.
- [40] Kletting M., Rauh A., Aschemann H. Hofer E. P. Consistency Techniques for Simulation of Wastewater Treatment Processes with Uncertainties, IFAC World Congress 2005, Prague, Czech Republic.
- [41] Lin H., Zhai, G. and Antsaklis P. J. Set-valued observer for a class of discrete-time uncertain linear systems with persistent disturbance. American Control Conference, Denver, Colorado, USA, June 4-6, 2003.
- [42] D. G. Maksarov and Norton J.P. Computationally efficient algorithms for state estimation with ellipsoidal approximations. *International Journal of Adaptive Control and Signal Processing*, 16 (6), pp. 411-434, 2002.
- [43] Mandel D., Abdollahzadeh A., Maquin D., Ragot J. Data reconciliation by inequality balance equilibration. A LMI approach. *International Journal of Mineral Processing*, 53, pp. 157-169, 1998.
- [44] Maquin D., Ragot J. Validation de données issues de systèmes de mesure incertains. *Journal Européen des Systèmes Automatisés*, RS-série JESA, numéro spécial "Applications des outils de calculs ensemblistes", 37 (9), p. 1163-1179, 2003.
- [45] Milanese M., Belforte G. Estimation theory and uncertainty intervals evaluation in presence of unknown but bounded errors: linear families of models. *IEEE Transactions on Automatic Control*, AC-27 (2), pp. 408-413, 1982.
- [46] Milanese M., Norton J., Piet-Lahanier H., Walter E. *Bounding approaches to system identification*. Plenum Press, New York and London, 1996.
- [47] Mo S.H., Norton J.P. Fast and robust algorithm to compute exact polytope parameter bounds. *Mathematics and Computers in Simulation*, 32 (5-6), pp. 481-493, 1990.
- [48] Moore R. E. Methods and applications of interval analysis. SIAM, Philadelphia, Pennsylvania, 1979.
- [49] Neumeier A. Interval methods for systems of equations. Cambridge University Press, 1990.
- [50] Norton J.P. Identification of parameter bounds for ARMAX models from records with bounded noise. *International Journal of Control*, 45 (2), pp. 375-390, 1987.

- [51] H. Piet-Lahanier, E. Walter, Limited-complexity polyhedral tracking, in M. Milanese, J. Norton, H. Piet-Lahanier, E. Walter (Eds.), *Bounding Approaches to System identification*. Plenum, New York, 1996, 261-273.
- [52] Ploix S., Adrot O. and Ragot J. Bounding approach to the diagnosis of a class of uncertain static systems. 4th Symposium on fault detection, supervision and safety for technical process, Safeprocess'2000, Budapest, Hungary, June 14-16, 2000.
- [53] Ploix S., Adrot O., Ragot J. Parameter uncertainty computation in static linear models. 38th Conference on Decision and Control, Phoenix, USA, pp. 1916-1921, December 14-15, 1999.
- [54] Ploix S., Follot C. Fault diagnosis reasoning for set-membership approaches and application. IEEE International Symposium on Intelligent Control (ISIC), Mexico City, Mexico, September 5-7, 2001.
- [55] Pronzato L., Walter E., Piet-Lahanier H. Mathematical equivalence of two ellipsoidal algorithms for bounded-error estimation. 28th IEEE Conference on Decision and Control, Tampa, USA, pp. 1952-1955, 1989.
- [56] Puig V., Quevedo J., Figueras J., Riera S., Cembrano G., Salamero M. and Wilhelmi G. Fault Detection and Isolation of Rain Gauges and Linnimeters of Barcelona's Sewer System using Interval Models. 5th IFAC Symposium on Fault Detection, Supervision and Safety of Technical Processes, Safeprocess 2003, Washington, D.C., U.S.A., pp. 621 - 626, June 2003.
- [57] Puig V., Sánchez A., Brdys M., Quevedo J. Robust Fault Detection using Envelopes generated through a Parameter Bounded Model: TEMPUS Workshop on Advanced Control Systems, Viena, Austria, 1996
- [58] Puig V., Quevedo J., Escobet T. and Stancu A. Robust Fault Detection Using Linear Interval Observers. 5th IFAC Symposium on Fault Detection, Supervision and Safety of Technical Processes, Safeprocess 2003, Washington, D.C., U.S.A., pp. 609 - 614, 2003.
- [59] Puig V., Saludes J., Quevedo J.. Worst-Case Simulation of Discrete Linear Time-Invariant Interval Dynamic Systems. *Reliable Computing*, 9(4), pp. 251-290, 2003.
- [60] Rapaport A. and Gouzé, J.-L.. Parallelotopic and practical observers for nonlinear uncertain systems. *International Journal of Control*, 76, pp. 237-251, 2003.
- [61] Ragot J., Boukhris A., Mandel D. A propos de l'algèbre des intervalles. Application à la validation de données. Rencontres Francophones sur la Logique Floue et ses Applications, LFA'97, Lyon, France, 3-4 décembre 1997.
- [62] Ragot J., Maquin D., Adrot O. LMI approach for data reconciliation. 38th Conference of Metallurgists, Symposium Optimization and Control in Minerals, Metals and Materials Processing, Quebec, Canada, August 22-26, 1999.

- [63] Ragot J., Maquin D. Reformulation of data reconciliation problem with unknown-but-bounded errors. *Industrial and Engineering Chemistry Research*, 43 (6), pp. 1530-1536, 2004.
- [64] Ragot J., Maquin D., Alhaj-Dibo M. Linear mass balance equilibration: a new approach for an old problem. *ISA Transactions*, 44 (1), pp. 23-35, 2005.
- [65] Rauh A., Kletting M., Aschemann H., Hofer E. P. Reduction of overestimation in interval arithmetic simulation of biological wastewater treatment processes, SCAN 2004, *Journal of Computational and Applied Mathematics*, Fukuoka, Japan.
- [66] Rauh A., Hofer E. P. Interval Arithmetic Optimization Techniques for Uncertain Discrete-Time Systems, 13th Int. Workshop on Dynamics and Control 2005, pp. 141-148, Wiesensteinig, Germany
- [67] Sainz M., Armengol J. and Vehi J. Fault detection and isolation of the three-tank system using the modal interval analysis. *Journal of Process Control*, 12 (2), pp. 325-338, 2002.
- [68] Sjahriari K., Adrot O., Flaus J.M. Analyse de sûreté de procédés multi-modèles par des méthodes à intervalles. Conférence Internationale Francophone d'Automatique, CIFA 2004, 22 - 24 novembre 2004, Douz, Tunisie.
- [69] Shamma J. S. and Tu K.-Y. Set-valued observers and optimal disturbance rejection, *IEEE Transactions on Automatic Control*, 44, pp. 253-264, 1999.
- [70] Steyer J.P., Harmand J., Valcaraz-Gonzalez V. Interval-Based Diagnosis of an Anaerobic Digester Pilot Plant. 4th Symposium on Fault Detection Supervision and Safety for Technical Processes, Safeprocess'2000, Budapest, Hungary, June 14-16, 2000.
- [71] Touaf S. and Ploix S. Soundly managing uncertain decisions in diagnostic analysis. 15th International Workshop on Principles of Diagnosis, DX'2004, Carcassonne, France, June 23-25, 2004.
- [72] Vicino A. and Zappa G. Adaptative approximation of uncertainty sets for linear regression models, in *Bounding approaches to system identification*, Milanese et al eds, pp. 159-181, 1996.
- [73] Walter E. and Piet-Lahanier H. Exact and recursive description of the feasible parameter set for bounded error models, 26th IEEE Conference on Decision and Control, Los Angeles, C.A., USA, pp. 1921-1922, December 9-11, 1987.
- [74] Walter E., Piet-Lahanier H. Exact recursive polyhedral description of the feasible parameter set for bounded-error models. *IEEE Transactions on Automatic Control*, 34 (8), pp. 911-915, 1989.

APPENDIX A: Review of interval arithmetic operators

This section reviews basic interval arithmetic operations and algorithms for interval computations used in the paper. Only real intervals are considered; as a definition, a real interval is a segment on the real number line and an interval vector of \mathbb{R}^v is an v -dimensional rectangle or "box" and is the Cartesian product of intervals. It should be noted that all continuous basic functions such as $\sin, \cos, \exp \dots$ extend easily to intervals.

Interval arithmetic takes into consideration the uncertainty of all of the parameters of a system and is able to provide strict bounds of the variables that are to be estimated. Initially, interval computation was developed to quantify the uncertainty of results calculated with a computer using a floating point number representation [48].

Definition or Operation	Formulation
Interval number	$\mathbf{x} \in [\underline{x}, \bar{x}]$ \underline{x} : lowerbound, \bar{x} : upperbound $\mathbf{x} = [\underline{x}, \bar{x}]$
Center Radius	$x_c = (\underline{x} + \bar{x})/2$ $x_r = (\bar{x} - \underline{x})/2$ $\mathbf{x} = x_c + \mu x_r, \mu \leq 1$
Interval addition	$\mathbf{z} = \mathbf{x} + \mathbf{y} = [\underline{x} + \underline{y}, \bar{x} + \bar{y}]$ $\mathbf{z} = \mathbf{x} - \mathbf{y} = [\underline{x} - \bar{y}, \bar{x} - \underline{y}]$
Interval multiplication	$\mathbf{z} = \mathbf{x}\mathbf{y}$ $\mathbf{z} = [\min(\underline{x}\underline{y}, \underline{x}\bar{y}, \bar{x}\underline{y}, \bar{x}\bar{y}), \max(\underline{x}\underline{y}, \underline{x}\bar{y}, \bar{x}\underline{y}, \bar{x}\bar{y})]$
Scalar multiplication	if $a > 0, \mathbf{z} = a\mathbf{x} = [a\underline{x}, a\bar{x}]$ if $a < 0, \mathbf{z} = a\mathbf{x} = [a\bar{x}, a\underline{x}]$
Interval division	$\mathbf{z} = \mathbf{x} : \mathbf{y} = [\underline{x}, \bar{x}] [\frac{1}{\bar{y}}, \frac{1}{\underline{y}}]$ unless $0 \in [\underline{y}, \bar{y}]$ in which case the result of division is undefined

Table 3: Interval arithmetic operations

An interval $[x]$ is a closed and connected subset of R . A box $[x]$ of R^n is a Cartesian product of intervals. The set of all boxes of R^n is denoted \mathbb{IR}^n . As real arithmetic operator, functions are extended to intervals. Given a function $f : \mathbb{R} \rightarrow \mathbb{R}$, a function $F : \mathbb{IR} \rightarrow \mathbb{IR}$ is an inclusion function of f if $\forall x \in [x], f(x) \in F([x])$. It is clear that inclusion function is not unique; the natural inclusion function is obtained by substituting all real arguments and elementary functions ($\log, \exp \dots$) by their extension to intervals. Often, interval computations overestimate the range of an expression. For example, [38], consider three formal expressions of the same function:

$$\begin{cases} f_1(x) = x(x + 2) \\ f_2(x) = x^2 + 2x \\ f_3(x) = x \times x + 2x \\ f_4(x) = (x + 1)^2 - 1 \end{cases} \quad (77)$$

On $[x] = [-1, 1]$, we have:

$$\begin{cases} [f_1][x] = [x]([x] + 2) = [-3, 3] \\ [f_2][x] = [x]^2 + 2 \times [x] = [-2, 3] \\ [f_3][x] = [x] \times [x] + 2 \times [x] = [-3, 3] \\ [f_4][x] = ([x] + 1)^2 - 1 = [-1, 3] \end{cases} \quad (78)$$

APPENDIX B: System of interval equations. Interval Gauss-Seidel iteration

Interval methods have been developed to solve a system of interval equations, i.e. equations in which the coefficients are uncertain but bounded. Consider a linear system of equations:

$$Ax = b \quad (79)$$

where $A \in \mathbb{R}^{n \times n}$, $b \in \mathbb{R}^n$ are bounded. Replacing the point valued coefficients in A and b with intervals results in non-parametric interval linear system:

$$[A]x = [b] \quad (80)$$

where $[A] \in \mathbb{IR}^{n \times n}$, $b \in \mathbb{IR}^n$. The set of all possible solution to (48) is:

$$S_x = \{x \in \mathbb{R}^n : \forall b \in [b], \forall A \in [A], Ax = b\} \quad (81)$$

At the k th iteration, compute for $i = 1..n$:

$$[y_i^{(k)}] = \frac{[b_i] - \sum_{j=1}^{i-1} [a_{ij}][x_j^{(k)}] - \sum_{j=i+1}^n [a_{ij}][x_j^{(k-1)}]}{[a_{ii}]} \quad (82a)$$

$$[x_i^{(k)}] = [y_i^{(k)}] \cap [x_i^{(k-1)}] \quad (82b)$$

To start the iteration, we require an initial solution $x^{(0)}$, choice of which seriously influences the convergence of the algorithm. The iterations can be terminated if the radii of the components of $x^{(k)}$ are no longer rapidly decreasing.

As an example, let us consider the particular case: $A = \begin{pmatrix} 2 & 1 \\ 1 & 2 \end{pmatrix}$ $b = \begin{pmatrix} [5.8 & 6.2] \\ [2.8 & 3.2] \end{pmatrix}$ Applying the recursion (82) gives the results gathered in table 4, x_1 and x_2 being the two components of x . The bounds x^- and x^+ are obtained iteratively starting with the arbitrary values -1 and 1 . Less than 10 iterations are needed to obtain the stabilisation of the sequence of iterates. We have also indicated the bounds y^- and y^+ of y . Here, the example is simple and allows a hand computation. The solution x is represented on figure 9 where are shown the interval solution (the rectangle shape) and the exact solution (the diamond shape). It is clear that the interval solution is an outer approximation of the true solution. Here the interval solution is:

$$x \in [2.8 \ 3.2], \quad y \in [-0.2 \ 0.2]$$

There are several possibilities allowing a better approximation. The subpaving approach consists in splitting the intervals into smaller intervals. For the given example, let us consider the

following partition:

$$b = \begin{pmatrix} [5.8 & 6.0] \\ [2.8 & 3.0] \end{pmatrix}, \quad b = \begin{pmatrix} [5.8 & 6.0] \\ [3.0 & 3.2] \end{pmatrix}, \quad b = \begin{pmatrix} [6.0 & 6.2] \\ [2.8 & 3.0] \end{pmatrix}, \quad b = \begin{pmatrix} [6.0 & 6.2] \\ [3.0 & 3.2] \end{pmatrix},$$

The results are indicated on figure 10 which clearly shows how the solution has been significantly improved. In fact, it is possible to increase the quality of the approximation by increasing the splitting of b .

k	x_1^-	x_1^+	x_2^-	x_2^+
1	-1.00	-1.00	1.00	1.00
2	2.40	2.60	0.10	0.40
3	2.70	3.05	-0.12	0.25
4	2.77	3.16	-0.18	0.21
5	2.79	3.19	-0.19	0.20
6	2.79	3.19	-0.19	0.20
7	2.80	3.19	-0.20	0.20
8	2.80	3.20	-0.20	0.20

Table 4: Interval arithmetic operations

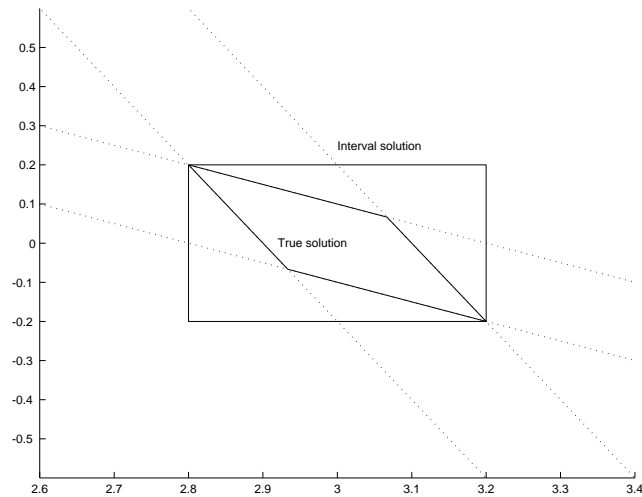

Figure 9: Interval linear system

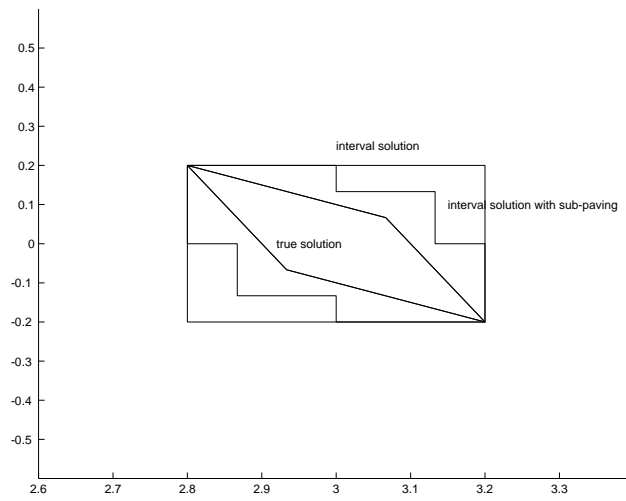

Figure 10: Interval linear system