



HAL
open science

Single used, robust, MEMS based electro-thermal micro switches for redundancy and system reconfiguration

Pierre Pennarun, Carole Rossi, Daniel Estève, David Colin

► To cite this version:

Pierre Pennarun, Carole Rossi, Daniel Estève, David Colin. Single used, robust, MEMS based electro-thermal micro switches for redundancy and system reconfiguration. *Sensors and Actuators*, 2007, 136 (1), pp.273-281. <10.1016/j.sna.2006.11.013>. <hal-00150266>

HAL Id: hal-00150266

<https://hal.science/hal-00150266v1>

Submitted on 29 May 2007

HAL is a multi-disciplinary open access archive for the deposit and dissemination of scientific research documents, whether they are published or not. The documents may come from teaching and research institutions in France or abroad, or from public or private research centers.

L'archive ouverte pluridisciplinaire HAL, est destinée au dépôt et à la diffusion de documents scientifiques de niveau recherche, publiés ou non, émanant des établissements d'enseignement et de recherche français ou étrangers, des laboratoires publics ou privés.



HAL Authorization

Single used, robust, MEMS based electro-thermal micro switches for redundancy and system reconfiguration

P. Pennarun, C. Rossi, D. Estève, D. Colin

LAAS-CNRS, 7 avenue du colonel Roche, 31077 Toulouse cedex 4, France

Abstract

A new type of one-shot MEMS based thermal micro switch is described and its performance results are presented. The device consists in mechanically breaking a metallic line or locally soldering two metallic lines. The switching between the two stable states (on or off) is accomplished by a current pulse through an integrated heater underneath the electrical lines needed to be interrupted or connected. Some key features are summarized as follows: switches are bistable, integratable and IC compatible. They are compatible with low voltage operation (5V), no contact resistance (0Ω for the on-off and $\sim 0.008 \Omega$ for the off-on); they are low energy consumption during switching (3.5mJ for on-off and 130mJ for off-on); switching current is between 10 and 20mA for on-off and between 50-70mA for off-on concept. The minimum switching pulse width is 7ms and 300ms for the on-off and off-on concept respectively; operation may be possible in ambient environment; lifetime expected is very long and both switches can therefore address long life system. Batch fabrication using planar processing methods are used.

1. INTRODUCTION

Micromechanical switches or relays are important applications of MEMS. Most of MEMS based microswitches are based on the deflexion of a cantilever or beam, supporting one electrical contact towards a second electrode to establish the electrical contact [1-10]. Numerous designs can be found in the literature to drive the two electrodes in contact and achieve low contact resistance, low power consumption, high isolation or actuation force. Actuations mechanisms are classic ones ie based on

electrostatic [1-4], electromagnetic [5][6], thermal [7][8] and piezoelectric [9] forces. Widest applications for MEMS relays are RF MEMS requiring a rapid switching (few microseconds) and high reliability for large numbers of switching. Some other published MEMS relay concepts are bistable [10], but, based on cantilever or beam design, they often stick after a long time in the on-state.

Other interesting applications of MEMS relay concern redundancy and system reconfiguration which are not addressed by papers. Redundancy switches are commonly used in critical embedded systems: the switch commutation is required once with a high reliability and after the commutation, the redundant system must operate with the same stability, performance and reliability as the principal one.

The well-known field of application of redundant relay is without doubt the satellite. Recent trends in space community for smaller, cheaper satellite bring the necessity to have highly integrated, IC compatible, low consuming redundancy switches and for reliability reason, without mechanical moving part. The configuration of electronic safety systems is also concerned with the same requirements as redundancy applications.

The paper presents a new family of electro-thermally actuated micro switches for redundancy and system reconfiguration. The on-off micro switch consists in mechanically breaking an electrical connection. The off-on micro switch consists in locally micro-soldering two insulated electrical connections when off-on switching is required. The switching between the two stable states (on or off) is accomplished by injecting a current pulse through an integrated heater underneath the electrical lines. The two micro switches have been designed for batch fabrication using planar processing methods and single use. They have been designed also to support relatively high currents. The principle of operation, design, fabrication and testing of these electro-thermally actuated micro switches are detailed.

2. ON-OFF MEMS BASED MICROSWITCH

2.1. Principle of operation

Two ways have been investigated to break the electrical line:

- The first one, called pyrotechnical on-off micro switch is an application of micro pyrotechnical actuator [11]. The electrical line is deposited on a thin dielectric membrane of a micropyrotechnical actuator (see Figure 1 (a)(b)). The micro heater heats up the high energetic material contained in the cavity underneath the membrane until its ignition temperature. The energetic material combustion starts and releases gas that break the dielectric membrane and with it the electrical connection.

- The second one, called thermal on-off micro switch consists in cutting an aluminium line that is deposited on top of one integrated micro heater (see Figure 1 (c)(d)). When the on-off switching is required, the micro heater heats up the aluminium line until its melting temperature (660°C) resulting in the rupture of the aluminium line.

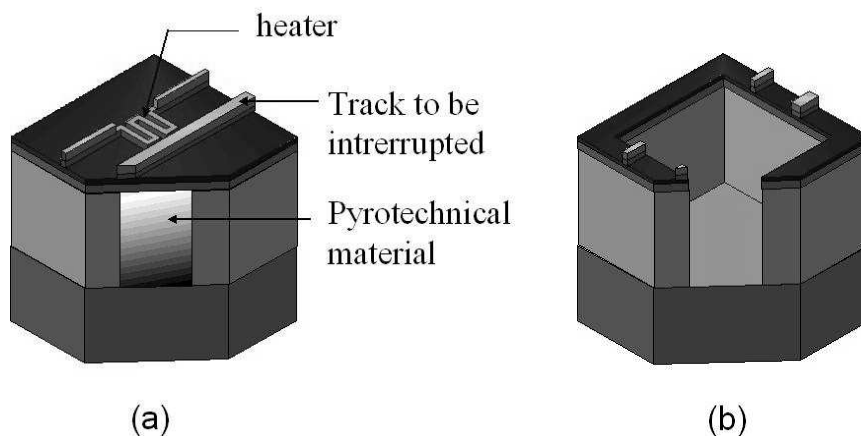

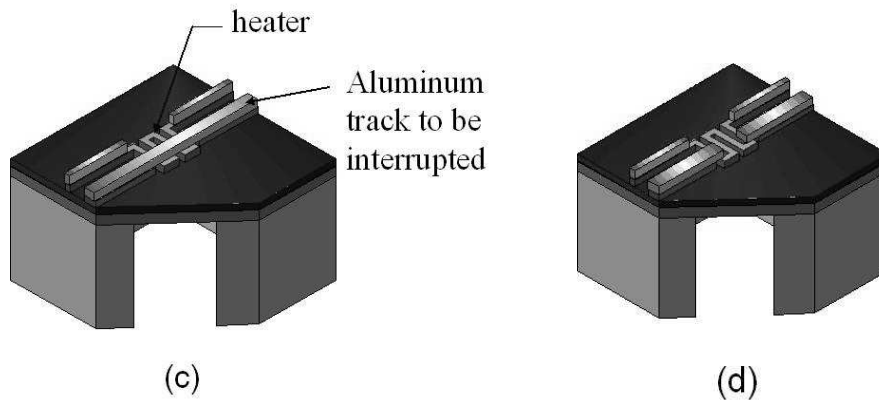

Figure 1. Illustration of the principle of operation of on-off microswitches: the pyrotechnical one (before (a) and after (b) switching) and thermal one (before (c) and after (d) switching) (not to scale)

2.2. Design and sizing

For both on-off micro switches, a SiO_2 ($1.4\mu\text{m}$) / SiN_x ($0.6\mu\text{m}$) sandwich composes the thin and low stressed membrane that can therefore support the heater and electrical line without breaking [12]. The advantages of this membrane are not only its thinness and robustness, but also its low thermal conductivity resulting in excellent heating performances (see section 2.4 and [12]). The micro heater element is a doped polysilicon serpentine with a total resistance of 500ohms. To demonstrate the concept, the silicon cavity and $\text{SiO}_2/\text{SiN}_x$ membrane is square and its area has been fixed at $1.5\text{mm}\times 1.5\text{mm}$. However, a cylindrical cavity would be possible and the dimensions could be greatly reduced if necessary.

For the pyrotechnical on-off microswitch, the electrical line can be any metal and must be placed near or on top of the micro heater (see Figure 2(a)). For the demonstrators, electroplated copper or evaporated aluminium have been deposited at $100\mu\text{m}$ from the microheater. The high energy material injected inside the micro cavity underneath the membrane is a composite GAP^1 based propellant.

¹ Glycidyle Azide Polymer

For the thermal on-off microswitch, the electrical line is simply an aluminium layer deposited on top of the polysilicon micro heater (see Figure 2(b)). Aluminium has been chosen for its good conductivity ($37.7 \cdot 10^4 \text{ S/cm}$) and low melting point (660°C).

Figure 2 gives an exploded view of both on-off microswitches with detailed dimensions and material types.

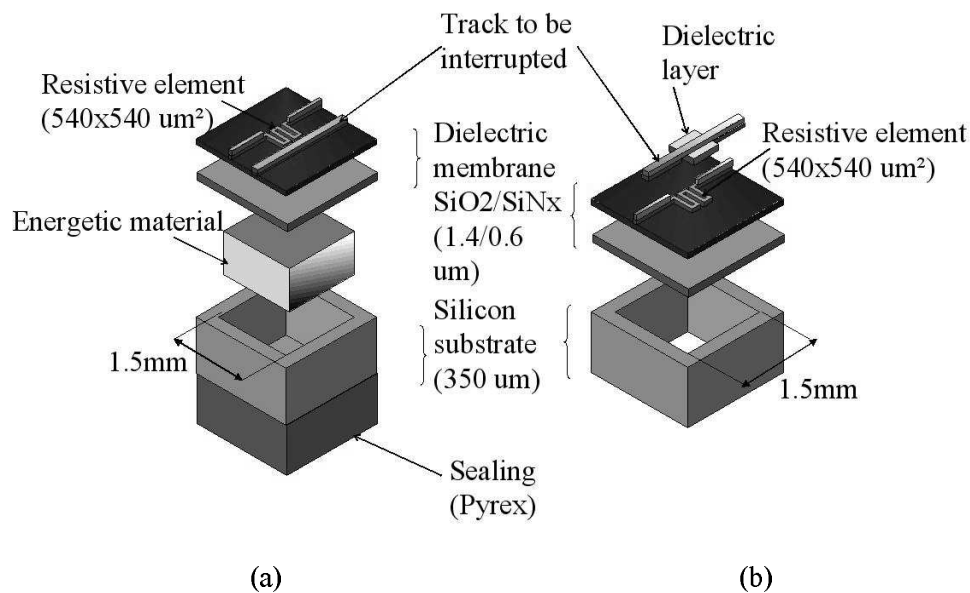

Figure 2. Exploded view of the pyrotechnical and thermal on-off micro switches (Not to scale)

2.3. Fabrication

The fabrication process of on-off microswitches is completely planar and IC compatible. The $350\mu\text{m}$ thick (100) oriented $4''$ silicon wafer is thermally oxidized on $1.4\mu\text{m}$ at 1150°C . It is then coated with a $0.6\mu\text{m}$ thick of silicon rich LPCVD (Low Pressure Chemical Vapor Deposition) nitride. These two layers form the $2\mu\text{m}$ thick low stressed membrane. A $0.5\mu\text{m}$ thick polysilicon layer is deposited by LPCVD at 605°C and N doped by the diffusion of phosphorus. Resulting resistivity is $8 \times 10^{-4} \text{ ohm.cm}^{-1}$.

Front side processing

The polysilicon layer is patterned using photolithography to define the heater resistors and etched away by Reactive Ion Etching (RIE). A $0.7 \mu\text{m}$ PECVD (Plasma Enhanced Chemical Vapor

Deposition) thick layer of low stressed oxide layer is then deposited and patterned using photolithography and removed in a HF bath everywhere except on the heater resistance. If the electrical track to be interrupted is placed near the heater, the 0.7 μ m PECVD deposition is not necessary.

Next step consists in making the metal layer. For the pyrotechnical on-off micro switches, a 5 μ m thick electrolytic copper is electroplated, whereas for the thermal on-off micro switches, a 0.7 μ m thick layer of aluminium is evaporated. The thin aluminium layer allows reducing the volume of aluminium to melt without having step covering problem.

Back side processing

The three thin back-side layers (doped Polysilicon, SiN_x and SiO₂) are removed by RIE. The silicon is then etched away by Deep Reactive Ion Etching (DRIE) to make the micro cavities. Figure 3 illustrates the different steps of the process.

Post processing

No post processing is needed for thermal on-off micro-switch. For the pyrotechnical on-off microswitch, post processing consists in injecting the energetic material into the silicon cavity (Figure 3 step 7) and in sealing the cavity with a pyrex plate (Figure 3 step 8). For our test, the energetic material being solid, it is cut and glued in contact with the membrane with thermal epoxy glue (H70E [13]) inside the silicon cavity. The same glue is also used to seal silicon with pyrex.

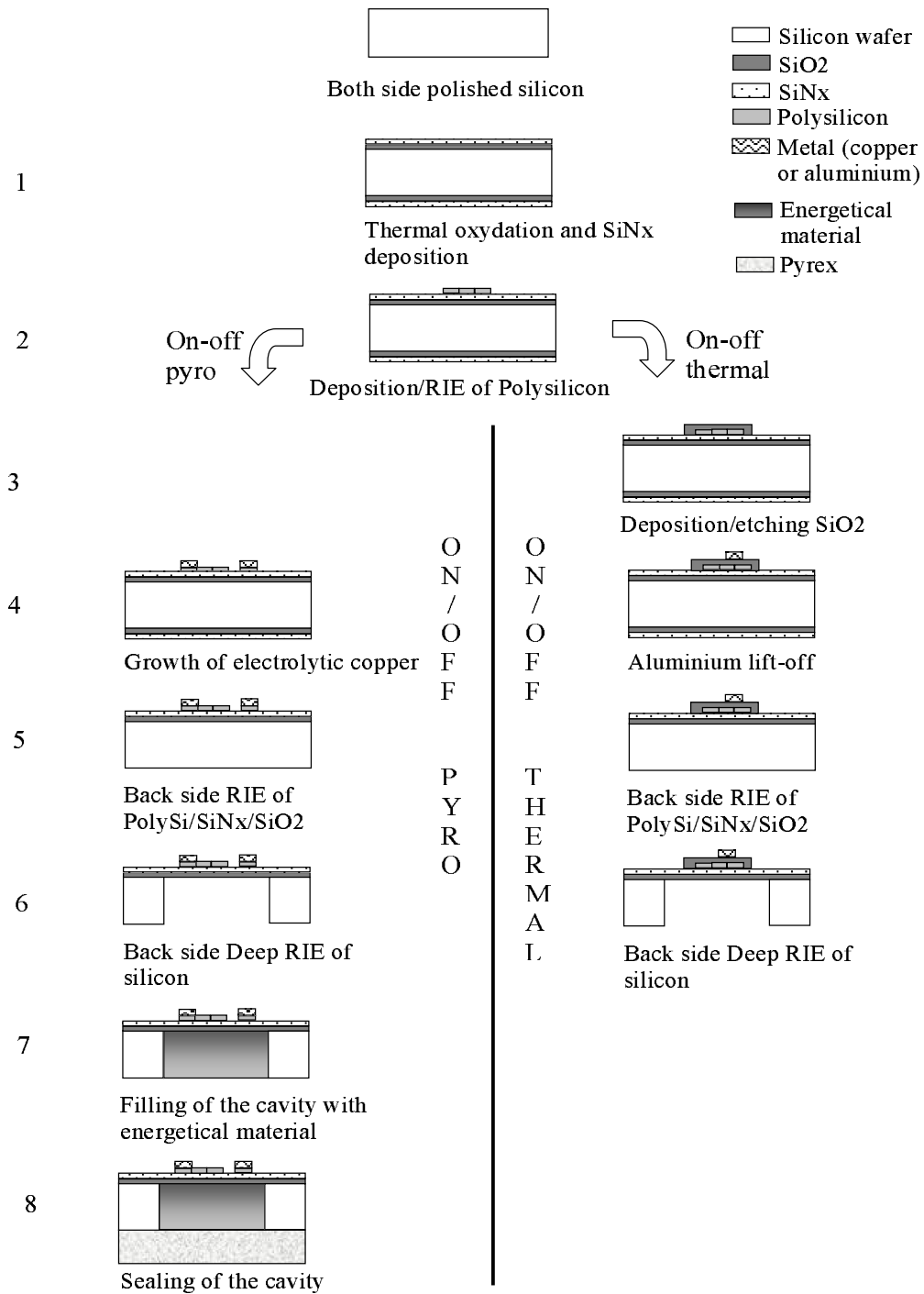

Figure 3. Illustration of the on-off pyrotechnical and thermal microswitches process steps

Figure 4 gives photos of realization. (a) is a top view of the pyrotechnical on-off micro switch: we see clearly the polysilicon micro heater with the copper line nearby. (b) is a top view of a thermal on-off micro switch : the aluminium line can be seen on the top and in the middle of the resistor.

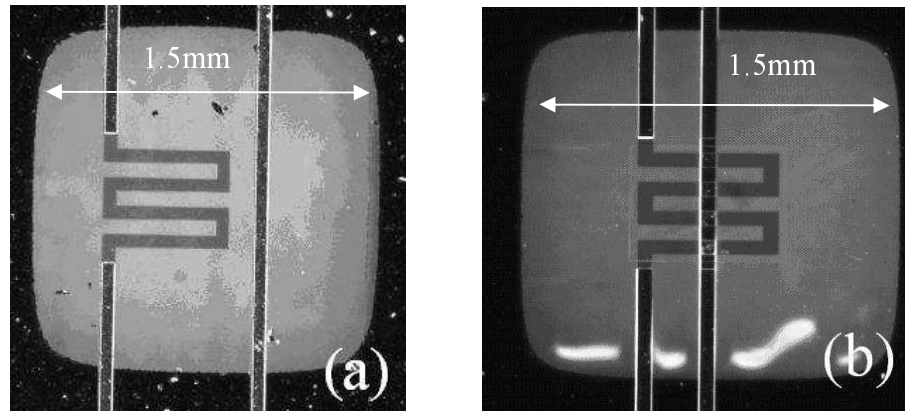

Figure 4. Photos of pyrotechnical and thermal on-off micro switches (a) polysilicon resistance on the membrane with the copper line nearby, (b) the polysilicon resistance on the membrane with the aluminium line on top.

2.4. Operation characteristics

Complete switches have been tested to determine the actuation power, time and the switching reliability.

2.4.1. On-off micro switches heater performances

The switching performances are closely linked to the integrated micro heater performances. Experimentations and FEM (Finite Element Modelling) with MEMCAD from CoventorWare® have been made to evaluate the micro switches microheater performances. Heater experimentations follow several steps. First, we evaluate the evolution of the polysilicon heater resistance (R_{heater}) with the temperature in an oven to get the $R_{heater}=f^*(T)$ curves. Then, the heater resistance is powered with a current (I_{in}), and the resulted potential is measured (V_{in}). R_{heater} calculated from V_{in}/I_{in} gives the value of T from the $R_{heater}(T)$ curve. Then $T(P_{in})$ curve is easily deduced with $P_{in}=V_{in}\times I_{in}$. The graphs of Figure 5 give both experimental and theoretical temperature as a function of the input switching power (P_{in}) for both pyrotechnical and thermal on-off micro switches.

* stands as a function of

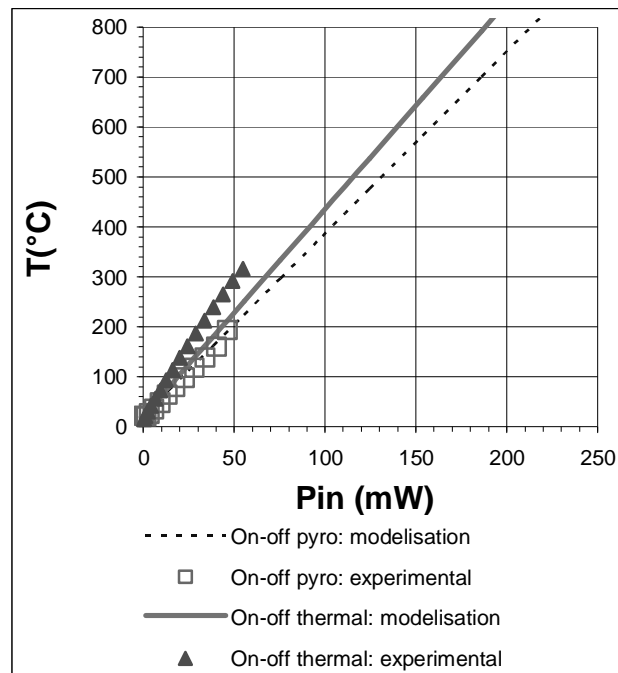
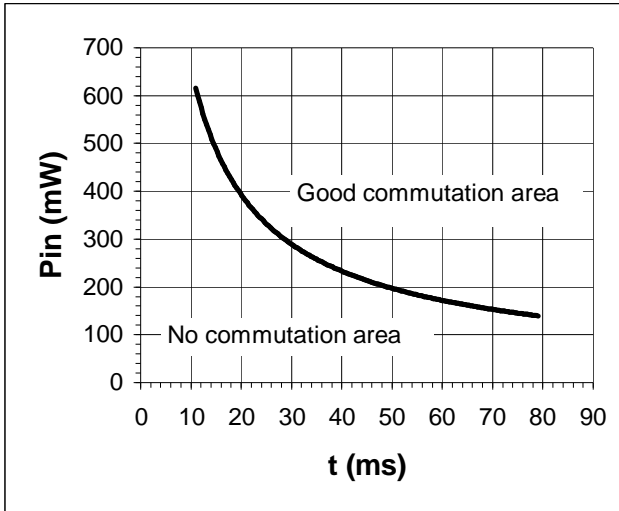
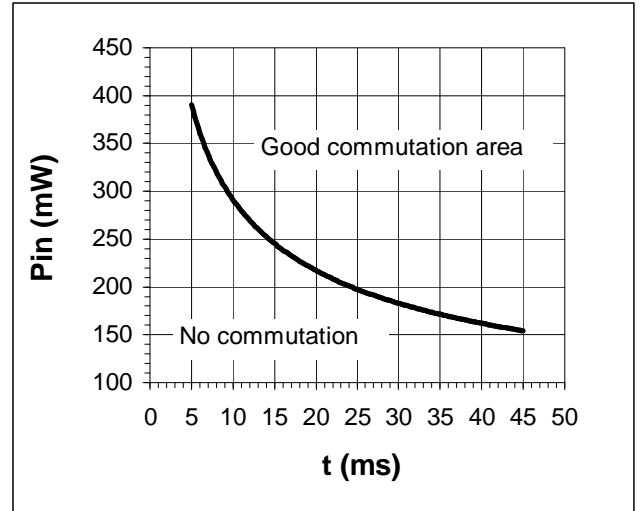

Figure 5. Static heater surface temperature (T) versus applied electrical power (P_{in}) for the on-off microswitches heaters

From the graph of Figure 5, we can deduce that a power of 150 mW is required to reach the fusion temperature of aluminium (660°C) and a minimum of 65mW is necessary to reach the energetic material ignition temperature (250°C).



(a)



(b)

Figure 1. Theoretical switching curves: applied electrical power versus commutation time for both pyrotechnical (a) and thermal (b) on-off microswitches

Switching time response is also an important feature for micro switch. The graphs given in the Figure 6 give the theoretical switching curves for both on-off micro switches: it corresponds to the heating time as a function of the input electrical power (P_{in}) to reach 250°C (propellant ignition temperature) and 660°C (aluminium fusion temperature) for the pyrotechnical and thermal on-off micro switches respectively.

2.4.2. Switching experimental characterisation

For each micro switch, the resistance was measured before and after switching by recording I_{switch} , V_{switch} curve. The R_{switch} is deduced by V_{switch} / I_{switch} . A Keithley 2400 sourcemeter has been used to produce V_{switch} ranging from 1V to 20V and to measure I_{switch} . Results are reported in Table 1 and Table 2 where R_{switch}^{before} and R_{switch}^{after} is the resistance before and after switching, respectively.

Then, to characterize the electrical switching characteristics a current pulse powers the heater resistance (R_{heater}) of about 1000ohm. The input pulse width (t_{in}) ranges from 1ms to 100ms and power

magnitude (P_{in}) from 60mW to 500mW. 500mW corresponds to a current of 22mA to a heater resistance of 1000ohm. After the application of the current input pulse, the switch resistance R_{switch}^{after} is recorded. The test bench consists in a current generator driven by a computer. The current generator can generate current up to 80mA with a rising time of 1.3 μ s. A feedback loop stabilizes current with a precision of 0.5mA. Interface with the computer is done by a PCI 6052E National Instrument board.

P_{in} (mW)	65	150	200	300	500
I_{in} (mA)	8.1	12.2	14.3	17.7	21.7
t_{in} (ms)	1000	100	70	45	25
$E_{in}=P_{in}\times t_{in}$ (mJ)	65	15	14	13.5	12.5
R_{heater} (Ω) (mean value)	1000	1000	975	960	1055
R_{switch}^{before} (mean value)	860	907	870	953	925
R_{switch}^{after} (mean value)	1000	∞	∞	∞	∞
Percentage of success (%)	1/5	1/5	1/5	3/5	3/5

Table 1. Characteristics of the pyrotechnical on-off microswitches

P_{in} (mW)	100	105	110	125	200	400	500
I_{in} (mA)	10	10.4	10.8	11.4	13.7	19.2	22.4
t_{in} (ms)	∞	65	65	40	17	10	7
$E_{in}=P_{in}\times t_{in}$ (mJ)	∞	6.8	7.15	5	3.4	4	3.5

$R_{heater} (\Omega)$ (mean value [*])	1000	975	945	961	1055	1086	998
R_{switch}^{before} (mean value)	1000	880	865	870	955	983	904
R_{switch}^{after} (mean value)	1000	∞	∞	∞	∞	∞	∞
Percentage of success [*] (%)	0	100	100	100	100	100	100

Table 2. Characteristics of the thermal on-off microswitches

As shown in Table 1, the pyrotechnical micro switch does not feature a good reliability. When 500mW was applied for 30ms, less than 90% of the membrane breaks and therefore switching has been achieved. The failure is probably due to bad contact between the heater/GAP energetic materials. The technology used for filling the micro cavity is sometimes defective: epoxy glues are bi-component glues and air bubbles are created when the two elements are mixed. To prevent this problem, the glue will be put under vacuum after mixing and before sticking the energetic material.

The thermal on-off micro switch, features excellent reliability and performances: 100% of tested switches commute from on to off stable state with only 3.5mJ: 500mW during 7ms. The commutation times measured are in good agreements with the theoretical curves. The experimentations prove that the switching can be achieved with less than 150mW (predicted by simulation) explained mainly by the variation of the thin film layer thickness during the microfabrication process.

* over at least 10 measurements

* over at least 10 measurements

To conclude the experimentation section, we plot the operation curves for the thermal micro on-off switches. The operation curve (Figure 7) defines the minimum values of P_{in} and T_{in} couple to have a reliable on-off switching. In consequence, one must place above the operating curve to make a reliable on-off micro switch. Pyrotechnical micro switches gave too bad reliability to plot an operation curve.

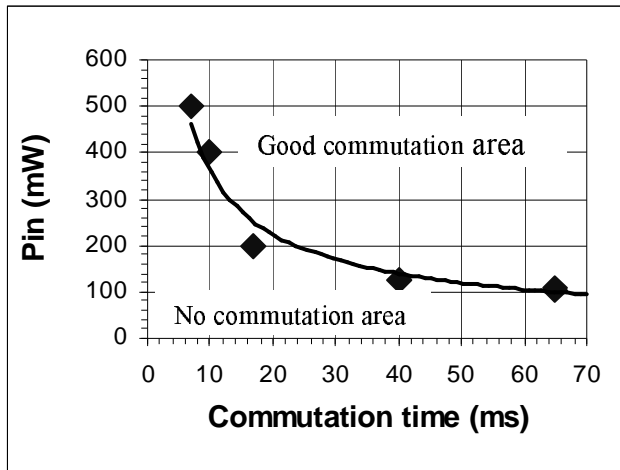

Figure 7. Thermal on-off micro switch operation curve

Photos of the thermal and pyrotechnical micro switches after actuation are given in the Figure 8.

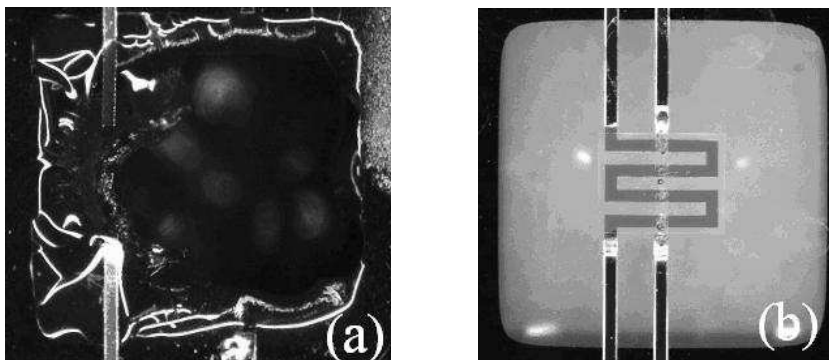

Figure 8. Photos of pyrotechnical (a) and thermal (b) micro switches after commutation

3. OFF-ON MEMS BASED MICROSWITCH

3.1. Principle of operation

The off-on microswitch consists in locally micro-soldering two insulated electrical connections when the off-on stable state switching is required. When heating, an intermetallic phase [14][15] is created by the interdiffusion between the molten solder (Sn/Pb) and the metallic tracks (Copper).

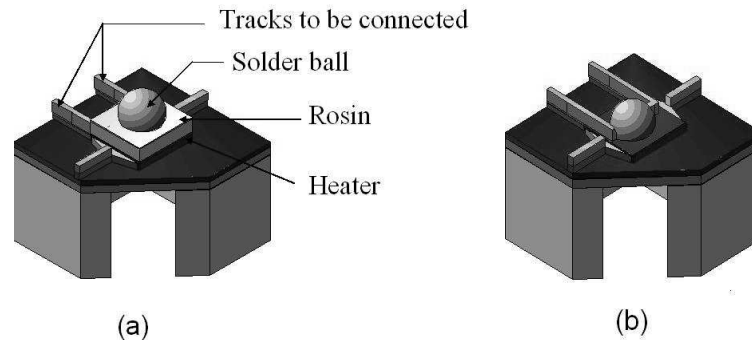

Figure 9. Illustration of the off-on microswitch operation principle: before (a) and after (b) switching
(Not to scale)

3.2. Design and sizing

To minimize the electrical power for soldering, the micro heater, the metal tracks and the soldering ball are supported on a thin SiO_2 ($1.4\mu\text{m}$) / SiN_x ($0.6\mu\text{m}$) membrane for the same reasons as the ones detailed in section 2.2.

A perforated square micro heater has been designed to obtain a plane surface on which the metal lines (copper) are deposited. Copper is chosen because of its excellent solderability [16]. The polysilicon micro heater size is of $690 \times 680 \mu\text{m}^2$ and is located in the center of the $1.5 \times 1.5 \text{mm}^2$ membrane. To be sure to pass directly from a solid phase to a liquid phase at a precise temperature (183°C), an eutectic Sn/Pb ball is used. Tracks and solder balls are insulated by a thin layer of rosin [17] which is a solid form of resin obtained from pine and some others plants having a melting temperature of 83°C . It is commonly used in the electronic industry in soldering flux to prevent oxidation, improve heat

exchange, promote wetting and attack oxides of soldering alloys. Rosin is also used to trap the solder ball above the heater. **Erreur ! Source du renvoi introuvable.** Figure 10 gives an exploded view of the off-on microswitch with material and main dimensional features.

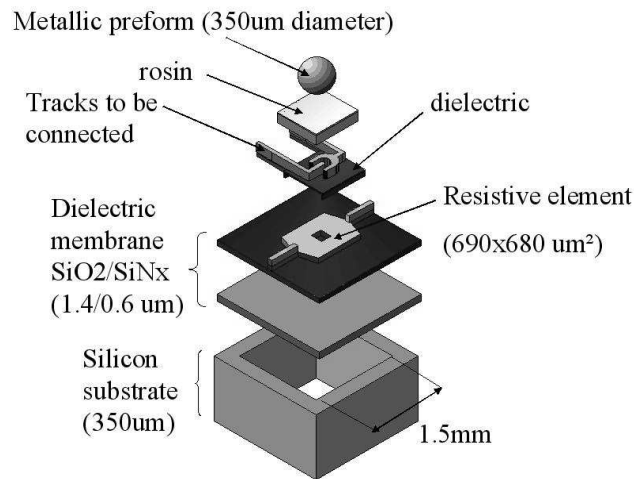

Figure 10. Exploded view of off-on microswitch (not to scale)

The copper line design and thickness have been determined empirically. Several tracks designs and copper thicknesses (1, 3, 5, 7 μ m) [18] have been realised and soldered with a \varnothing 350 μ m Sn/Pb ball. Then, the contact resistance after soldering (R_{switch}^{after}) has been checked for the different shapes and copper thicknesses to find the best couple (shape and thickness). Best soldering results (R_{switch}^{after} < 0.01ohm and 100% of success) were obtained with the designs of Figure 11 and for a copper layer thicker than 3 μ m.

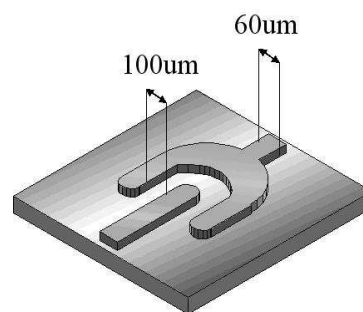

Figure 11. Electrical track shape retained for its good soldering results

3.3. Fabrication

The first 6 steps of the process are the same as for the fabrication of the on-off pyrotechnical and thermal microswitches (see Figure 3 steps 1-6). The copper tracks are 5 μ m thick and a thin insulation layer being a 0.7 μ m PECVD of low stressed oxide covers the polysilicon resistor.

The seventh step is the rosin deposition between the two tracks by stamping (see Figure 12 step 7). The substrate and rosin reservoir are heated at 150°C to obtain a good viscosity of the rosin. The rosin geometry has been evaluated with optic profilometry from Veeco. The average deposited volume is of 7.5 μ l (+/- 2.5 μ l). A \varnothing 350 μ m Sn/Pb solder ball from Indium Corporation is then deposited on the rosin (see Figure 12 step 8). Finally, the substrate is cooled down to solidify the rosin which traps the solder ball.

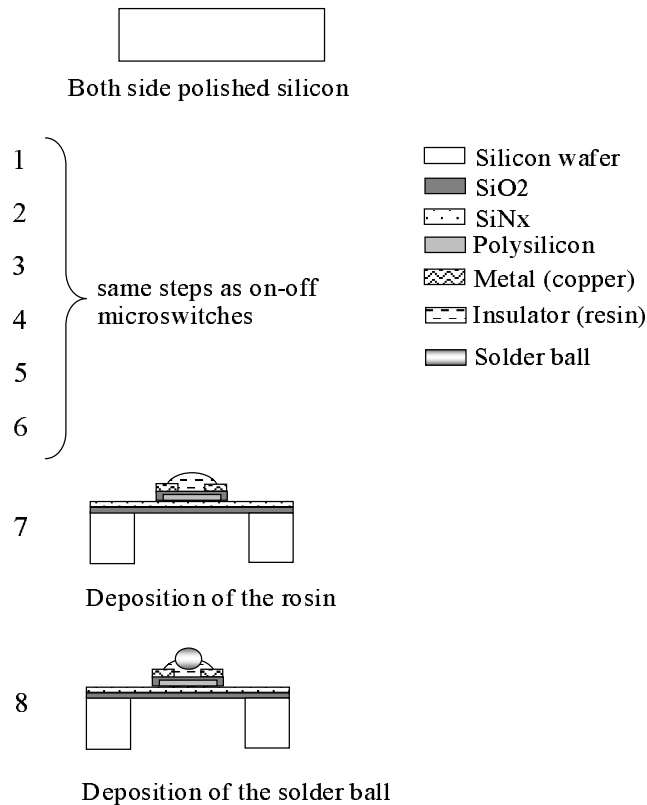

Figure 12. Sequences of steps to fabricate and assemble off-on switches

The photo given in the Figure 13 shows an off-on microswitch after its fabrication.

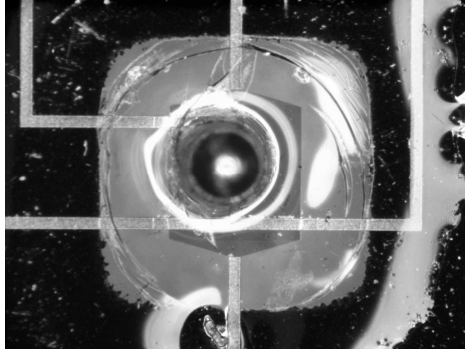

Figure 13. Photo of an off-on micro switch: the solder ball is deposited on top of the heater and rosin spread on the whole membrane can be seen.

3.4. Operation characteristics

Complete switches have been tested to determine the actuation power, time and the switching reliability.

3.4.1. Off-on micro switch heater performances

The graphs in Figure 14 show the maximum temperature on the surface of the off-on switch heater (T_{heater}) and in the middle of the solder ball (T_{solder}) as a function of the input power (P_{in}). Results are obtained both experimentally and by simulation (FEM) for T_{heater} and only by Finite Element modelling for T_{solder} .

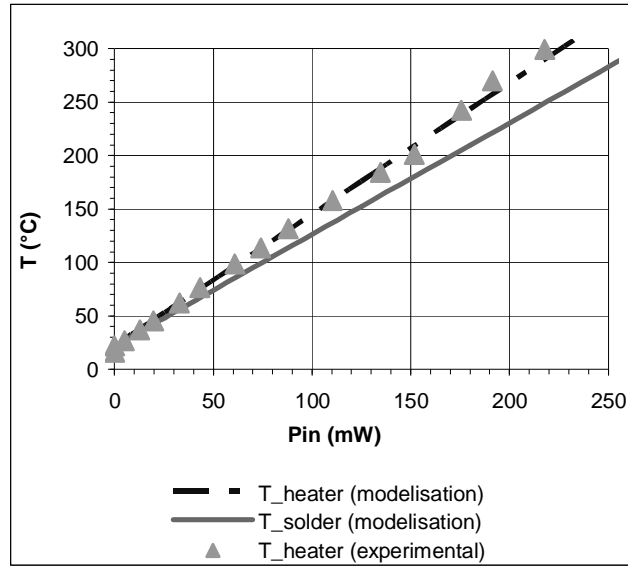

Figure 14. Static temperature as a function of the electrical power (P_{in}) at the surface of the heater (T_{heater}) and in the middle of the Sn/Pb solder ball (T_{solder}).

The minimum power required to melt the solder ball is theoretically of 170mW.

3.5. Switching characterisation

The resistance was measured before and after switching by recording I_{switch} , V_{switch} curve. The R_{switch} is deduced by V_{switch} / I_{switch} . A Keithley 2400 sourcemeter is used to produce V_{switch} ranging from 1V to 20V and to measure I_{switch} . Results are reported in Table 3 where R_{switch}^{before} and R_{switch}^{after} is the resistance before and after switching, respectively.

To characterize the electrical switching, a constant current pulse powers the heater resistance (R_{heater}) of about 70ohms. The input pulse width (t_{in}) ranged from 100ms to 3000ms and power magnitude (P_{in}) from 200mW to 400mW. 400mW corresponds to a current of 75 mA to a heater resistance of 70ohm. During the application of the current input pulse, the switch resistance R_{switch}^{after} was recorded until its commutation from ∞ to a few milliohms. The test bench is the same as the one used for the on-off microswitches tests.

P_{in} (mW)	200	225	250	275	300	350	400
---------------	-----	-----	-----	-----	-----	-----	-----

$I_{in} (mA)$	56	55.6	56	59.2	59.5	68.7	73.2
$t_{in} (ms)$	3000	1300	900	600	500	370	320
$E_{in}=P_{in}\times t_{in}$ (mJ)	600	292.5	225	165	150	129.5	128
$R_{heater} (\Omega)$ (mean value*)	64	72.6	80	78.5	84.75	74.2	74.6
$R_{switch}^{before} (\Omega)$	∞	∞	∞	∞	∞	∞	∞
$R_{switch}^{after} (\Omega)$	<0.008	<0.008	<0.008	<0.008	<0.008	<0.008	<0.008
Percentage of success (%)	100	100	100	100	100	100	100

Table 3. Characteristics of the thermal off-on microswitches

As shown in the table 3, the off-on micro switch concept features excellent off-on commutation reliability: 100% of switches commute from on to off stable state. It takes about 130mJ : 500mW during 320ms which can seem long but correct for redundancy application. The commutation energy can be reduced by decreasing the Sn/Pb ball diameter or depositing a thin electroplated SnPb layer.

No soldering was observed for electrical powers less than 200mW, whereas the theoretical evaluation gave a minimum power of 170mW (Figure 14). This difference is surely due to the uncertainty of the rosin thickness. After the soldering is done ($R_{switch}^{after} < 0.008\text{ohm}$), currents of 50mA, 500mA and 1A are applied to the copper line of the switch during 5min and the contact resistance is followed. No fluctuation in the resistance of the contact resistance was followed and remained stable in time.

The operation curve of the micro off-on switches is plotted on the Figure 15. One must place above the operating curve to make a reliable off-on micro switch.

* Over at least 10 measurements

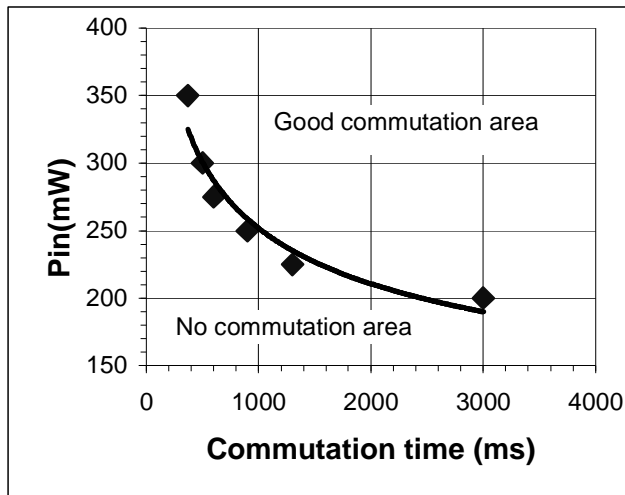

Figure 15. Thermal off-on micro switch operation curve

Photos of the thermal off-on micro switches after actuation are given in the Figure 16. We can guess solder spread on the two tracks (A) as well as some rosin marks (B).

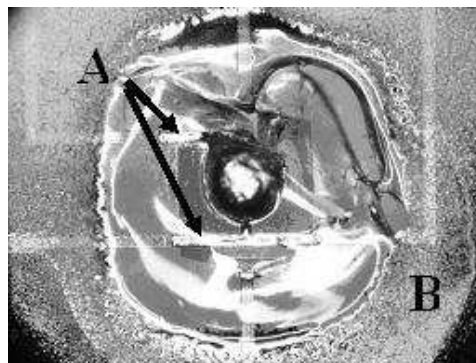

Figure 16. Photo of the off-on micro switch after the commutation is done in the on state

4. CONCLUSIONS AND PROSPECTS

The detailed design, sizing and the fabrication process of MEMS based robust microswitches have been presented. Excellent fabrication yield have been reached (99%) whereas progresses are still

required to better inject the energetic material inside the micro cavities for pyrotechnical microswitches. Thermal on-off and off-on microswitches characterizations gave encouraging results:

- ◆ 100% of off-on microswitches commute from on to off stable state with 130mJ (400mW during 320ms). The commutation energy can be reduced by decreasing the Sn/Pb ball diameter or depositing electroplated SnPb layer.
- ◆ 100% of thermal on-off tested microswitches commute from on to off stable state with only 3.5mJ (500mW during 7ms).

The proposed electro-thermal switches present valuable advantages and assets for redundancy application i.e when the electrical commutation (from on-to-off or off-to-on) is necessary once and after a long storage time. They can be summarized as follow:

- When the switches are in the on or off stable state, there is no contact resistance.
- Their functioning principles are very simple, reliable and stable in time: there are no moving parts, therefore no sticking problem.
- No energy is needed to keep the switches in the stable on or off states.

ACKNOWLEDGMENTS

The authors would like to thank F. Bourrières and C. Kaiser from NOVATEC², for its collaboration and assistance in the micro switch development. We also thank DGA³ (Délégation Générale de l'Armement) for its support. Finally, we thank D. Lagrange, N. Mauran, S. Assié their help during characterization.

² 350, Avenue d'Italie, ZA albasud, 82000 Montauban, France

<http://www.novatec-eap.com/>

³ <http://www.defense.gouv.fr/dga>

References

- [1] Ling Wang, Zheng Cui, Jia-Sheng Hong, Eamon P. McEearlean, Robert B. Greed, Daniel C. Voyce, Fabrication of high power RF MEMS switches, *Microelectronic engineering* Vol. 83, 2006, p. 1418-1420
- [2] Joachim Oberhammer, Göran Stemme, Design and Fabrication Aspects of an S-shaped Film Actuator Based DC to RF MEMS switch, *Journal of micromechanical systems*, vol.13, No. 3, June 2004, p.421-427
- [3] S . Majumber, J. Lampen, R. Morrison, J.Maciel, MEMS switches :a newly developed surface micromachined direct metal to metal microswitch can be used in application from dc through microwave, *IEEE instrumentation and measurement magazine*, Vol.6, Issue 1, March 2003, p.12-15
- [4] Han S. Lee, Chi H. Leung, Jenny Shi, Shih-Chia Chang, Micro-Electro-Mechanical Relays-Design Concepts and Process Demonstrations, *Electrical Contacts*, 2004. Proceedings of the 50th IEEE Holm Conference on Electrical Contacts and the 22nd International Conference on Electrical Contacts, 2004, p.242-247
- [5] O. Cugat, G Reyne, J. Delamare, H. Rostaing, Novel Magnetic micro-actuators and system (MAGMAS) using permanent magnets, *Sensors and Actuators A*, Vol. 129, 2006, p. 265-269
- [6] John D. Williams, ren Yang, Wanjun Wang, Numerical simulation and test of a UV-LIGA fabricated electromagnetic micro-relay for power applications, *Sensors and Actuators A*, Vol. 120, 2005, p. 154-162
- [7] Eniko T. Enikov, Kalin Lazarov, PCB-integrated metallic thermal micro-actuators, *Sensors and Actuators A: Physical*, Vol. 105, Issue 1, p. 76-82
- [8] Vivek Agrawal, A latching MEMS Relay for DC and RF Applications, *Electrical Contacts*, 2004. Proceedings of the 50th IEEE Holm Conference on Electrical Contacts and the 22nd International Conference on Electrical Contacts, 2004, p.222-225

- [9] Hee-Chul Lee, Jae-Yeong Park, Jong-Uk Bu, Piezoelectrically Actuated RF MEMS DC Contact Switches With Low Voltage Operation, IEEE Microwave and wireless components letters, Vol.15, No.4, April 2005, p.202-204
- [10] Rogier A M Receveur, Michael Zickar, Cornel Marxer, Vincent Larik and Nicolaas F de Rooij, Wafer level hermetic package and device testing of a SOI-MEMS switch for biomedical applications, J. Micromech. Microeng. 16 (2006) 676–683
- [11] C. Rossi, D. Estève, Micropyrotechnics, a new technology for making energetic microsystems: review and prospective, Sensor and Actuator A: Physical, Vol. 120, 2005, p. 297-310
- [12] C. Rossi, P. Temple-Boyer, D. Estève, Realization and performance of thin SiO₂/ SiN_x membrane for micro-heater applications, Sensors and Actuators A: Physical, Vol. 64, 1998, p. 241-245
- [13] <http://www.polytec-pi.fr/EPOTEK-1/datasheets/H70E%20CFDS.PDF>
- [14] K.N Tu, K. Zeng, Tin-Lead (SnPb) solder reaction inflip chip technology, Material Science and engineering, R 34, 2001, p. 1-58
- [15] M. Scafer, R.A. Fournelle, J. Liang, Theory for Intermetallic Phase Growth Between Cu and Liquid Solder Based on Grain Boundary Diffusion Control, Journal of Electronic Materials, Vol.27, No. 11, 1998, p.1167-1176
- [16] <http://www.efunda.com/materials/solders>
- [17] <http://www.reference.com/browse/wiki/Rosin>
- [18] P. Pennarun, C. Rossi, D. Estève and D. Bourrier, Design, fabrication and characterization of a MEMS safe pyrotechnical igniter integrating arming, disarming and sterilization functions, Journal of micromechanical and microengineering, 16 (2006), p.92-100

