



HAL
open science

A LPV based semi-active suspension control strategy

Charles Poussot-Vassal, Olivier Sename, Luc Dugard, Peter Gaspar, Zoltan Szabo,
Jozsef Bokor

► **To cite this version:**

Charles Poussot-Vassal, Olivier Sename, Luc Dugard, Peter Gaspar, Zoltan Szabo, et al.. A LPV based semi-active suspension control strategy. SSSC 2007 - 3rd IFAC Symposium on System, Structure and Control, Oct 2007, Foz do Iguaçu, Brazil. pp.6. <hal-00148831>

HAL Id: hal-00148831

<https://hal.science/hal-00148831v1>

Submitted on 29 Oct 2007

HAL is a multi-disciplinary open access archive for the deposit and dissemination of scientific research documents, whether they are published or not. The documents may come from teaching and research institutions in France or abroad, or from public or private research centers.

L'archive ouverte pluridisciplinaire **HAL**, est destinée au dépôt et à la diffusion de documents scientifiques de niveau recherche, publiés ou non, émanant des établissements d'enseignement et de recherche français ou étrangers, des laboratoires publics ou privés.



HAL Authorization

A LPV BASED SEMI-ACTIVE SUSPENSION CONTROL STRATEGY

C. Poussot-Vassal¹ * O. Sename * L. Dugard *
P. Gáspár ** Z. Szabó ** J. Bokor **

* GIPSA-lab (former LAG), Grenoble, France

** Computer and Automation Research Institute, Hungary

Abstract: In this paper we consider the design and analysis of a semi-active suspension controller. In the recent years different kinds of semi-active control strategies, like two-state Skyhook, LQ-clipped or model-predictive, have already been developed in the literature. In this paper we introduce a new semi-active suspension control strategy that achieves a priori limitations of a semi-active suspension actuator (dissipative constraint and force bounds) through the Linear Parameter Varying (LPV) theory. This new approach exhibits some interesting advantages compared to already existing methods (implementation, performance flexibility, robustness etc.). Both industrial criterion evaluation and simulations on nonlinear quarter vehicle model are performed to show the efficiency of the method and to validate the theoretical approach.

Keywords: Semi-active suspension, Linear Parameter Varying (LPV), \mathcal{H}_∞ Control, Linear Matrix Inequality (LMI).

1. INTRODUCTION

Suspension system's aim is to isolate passenger from road irregularities keeping a good road holding behavior. Industrial and scientist research is very active in the automotive field and suspension control and design is an important aspect for comfort and security achievements. In the last decade, many different active suspension system control approaches were developed: Linear Quadratic (e.g. Hrovat 1997), Skyhook (e.g. Poussot-Vassal *et al.* 2006), that suits well to improve comfort. Robust Linear Time Invariant (LTI) \mathcal{H}_∞ (e.g. Rossi and Lucente 2004) can achieve better results improving both comfort and road holding but which is limited to fixed performances (due to fixed weights), Mixed LTI $\mathcal{H}_\infty/\mathcal{H}_2$ (see Gáspár *et al.* 1998, Lu and DePoyster 2002, Takahashi

et al. 1998) can improve \mathcal{H}_∞ control reducing signals energy. Recently, Linear Parameter Varying (LPV) (e.g. Fialho and Balas 2002, Gáspár *et al.* 2004), that can either adapt the performances according to measured signals (road, deflection, etc.) or improve robustness, taking care of the nonlinearities (see Zin *et al.* 2006). Most of these controllers are designed and validated assuming that the actuator of the suspension is active. Unfortunately such active actuators are not yet used on a wide range of vehicles because of their inherent cost (e.g. energy, weight, volume, price, etc.) and low performance (e.g. time response); hence, in the industry, semi-active actuators (e.g. controlled dampers) are often preferred. The two-state skyhook control is an on/off strategy that switches between high and low damping coefficient in order to achieve body comfort specifications. Clipped approaches leads to unpredictable behaviors and reduce the achievable performances. In

¹ Corresponding author: Tel.: +33 4 76 82 71 51; Fax.: +33 4 76 82 63 88. E-mail: charles.poussot@gipsa-lab.inpg.fr

Giorgetti *et al.*'s (2006) article, authors compare different semi-active strategies based on optimal control and introduce an hybrid model predictive control and introduce an hybrid model predictive optimal controller. The resulting control law is implemented by an hybrid controller that switches between a large number (function of the prediction horizon) of controllers and requires a full state measurement. In Canale *et al.*'s (2006) paper, another model-predictive semi-active suspension is proposed and results in good performances compared to the Skyhook and LQ-clipped approaches but requires an on-line "fast" optimization procedure. As it involves optimal control, full state measurement and a good knowledge of the model parameters are necessary.

The contribution of this paper is to introduce a new methodology to design a semi-active suspension controller through the LPV technique. The main interest of such an approach is that it a priori fulfills the dissipative actuator constraint and allows the designer to build a controller in the robust framework (\mathcal{H}_∞ , \mathcal{H}_2 , Mixed etc...). As long as the new method does not involves any on-line optimization process and only requires a single sensor, it could be an interesting algorithm from the applications point of view.

The paper is organized as follows: in Section 2 we both introduce linear and nonlinear quarter car models used for synthesis and validation. In Section 3, the involved semi-active suspension actuator system (based on real experimental data) is described. In Section 4 the proposed semi-active LPV/ \mathcal{H}_∞ control design and its scheduling strategy are presented. In Section 5, both industrial based performance criterion and simulations on a nonlinear quarter vehicle model show the efficiency of the proposed method. Conclusions and perspectives are discussed in Section 6.

2. QUARTER CAR MODEL

The simplified quarter vehicle model involved here includes the sprung mass (m_s) and the unsprung mass (m_{us}) and only catches vertical motions (z_s , z_{us}). As the damping coefficient of the tire is negligible, it is simply modeled by a spring linked to the road (z_r) where a contact point is assumed. The passive suspension, located between m_s and m_{us} , is modeled by a damper and a spring as on Figure 1 (left).

The nonlinear "Renault M3gane Coup3" based passive model, that will be later used as our reference model (for performance evaluation and comparison with the controlled one), is given by:

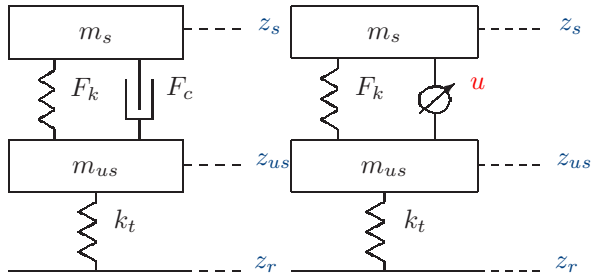

Fig. 1. Passive (left) Controlled (right) quarter car model.

$$\begin{cases} m_s \ddot{z}_s = -F_k(z_{def}) - F_c(\dot{z}_{def}) \\ m_{us} \ddot{z}_{us} = F_k(z_{def}) + F_c(\dot{z}_{def}) - k_t(z_{us} - z_r) \\ z_{def} \in [\underline{z}_{def} \ \bar{z}_{def}] \end{cases} \quad (1)$$

where $F_k(z_{def})$ and $F_c(\dot{z}_{def})$ are the nonlinear forces provided by the spring and damper respectively (see dashed curves on Figure 2).

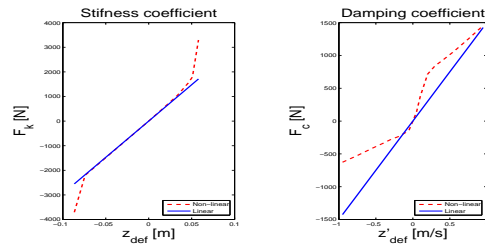

Fig. 2. Nonlinear (dashed) and Linear (solid) Spring (left) and the Damper (right) forces.

In the controlled suspension framework, one considers the model given on Figure 1 (right) and described by,

$$\begin{cases} m_s \ddot{z}_s = -F_k(z_{def}) + u \\ m_{us} \ddot{z}_{us} = F_k(z_{def}) - u - k_t(z_{us} - z_r) \\ z_{def} \in [\underline{z}_{def} \ \bar{z}_{def}] \end{cases} \quad (2)$$

where u is the control input of the system, provided by the considered actuator. Note that in this formulation, the passive damper that appears in equation (1) is replaced by an actuator or a controlled damper.

3. SEMI-ACTIVE SUSPENSION ACTUATOR

In the previous section, the u control input was introduced to control the quarter car model. Since we focus here on semi-active suspension control, in the sequel, emphasis is put on static performances and structural limitations for the considered semi-active actuator.

3.1 Active vs. Semi-active suspension systems

Active suspension systems can either store, dissipate or generate energy to the masses (m_s and

m_{us}). When semi-active suspension actuators are considered, only energy dissipation is allowed. This difference is usually represented using the Force-Deflection speed space representation given on Figure 3. Hence, a semi-active controller can only deliver forces within the two semi-active quadrants. Note that when a full active actuator is considered, all the four quadrants can be used.

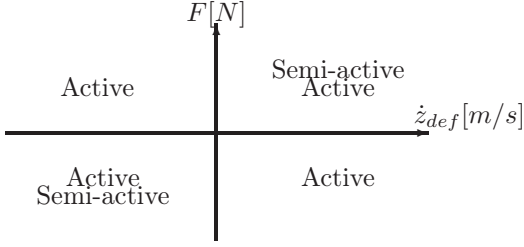

Fig. 3. Active vs. Semi-active quadrant.

3.2 The Magneto-rheological damper

The actuators considered here are called semi-active Continuously Controlled Dampers (CCD). For this kind of controlled damper, it is assumed that all the forces within the allowed semi-active space quadrants can be achieved (Figure 3). In our application, we consider a magneto-rheological (M-R) damper (more and more studied and used in the industry because of its great performances) (see Du *et al.* 2005). Through the change of current input, M-R damper viscosity can be adjusted (i.e. the damping coefficient). The main advantages of such an actuator are that the weight and the volume are similar to classic passive dampers and the range of damping coefficients is nearly infinite within the bounded area. In the meantime, the time response is very fast (about 10ms), compared to an active hydrological actuator.

For this purpose, we consider a Delphi M-R damper available in the Tecnologico de Monterrey (see Nino *et al.* 2006). To evaluate the upper and lower capacities of this actuator, a sinusoidal disturbance of frequency 0.25Hz is generated at the extremity of the suspension (equivalent to a deflection disturbance) for different magnitudes of current in order to measure the achievable forces of this damper. Figure 4 shows results for two different current values.

Note that, due to hysteresis behavior of such actuators (see Du *et al.* 2005), some points are in the actives quadrants.

3.3 Semi-active suspension static model

According to Figure 4, a static model of the considered damper is derived. It simply consists of upper and lower bound of the achievable forces

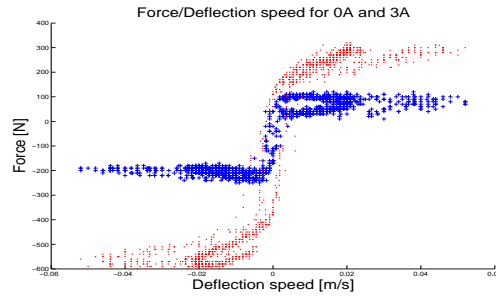

Fig. 4. Delphi Force-Deflection speed diagrams for different current (0A cross, and 3A dots).

of the damper and will be denoted as D . Then, for a given deflection speed (\dot{z}_{def}), if the controller computes a force F^* out of the achievable damper range, the force provided to the system will be F^\perp the projection of F^* on the possible force area (see Figure 5).

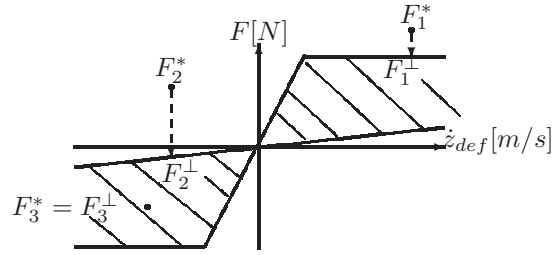

Fig. 5. Projection principle of the semi-active controlled damper model (F_1^* and F_2^* are out of the allowed area and F_3^* is inside).

4. LPV BASED ROBUST SEMI-ACTIVE SUSPENSION CONTROL DESIGN

For controller synthesis purpose we consider the model described in (1) where $F_k(z_{def})$ and $F_c(\dot{z}_{def})$ are linear functions (see solid curves on Figure 2). The control law, applied on model (2), is then given by: $u = -c \cdot (\dot{z}_{def}) + u^{\mathcal{H}_\infty}$

where c is the nominal linearized damping coefficient of the M-R damper and $u^{\mathcal{H}_\infty}$ the added force provided by the controller. To account for actuator limitations shown in Section 3, we propose a new method based on the LPV polytopic theory using the \mathcal{H}_∞ synthesis approach.

4.1 Frequency based industrial performance criterion

In the sequel, we introduce four performance objectives derived from industrial specifications (see Sammier *et al.* 2003).

Comfort at high frequencies: vibration isolation between $[4 - 30]$ Hz is evaluated by \ddot{z}_s/z_r .

Comfort at low frequencies: vibration isolation between $[0 - 5]$ Hz is evaluated by z_s/z_r .

Road holding: wheel are evaluated by z_{us}/z_r between $[0 - 20]$ Hz.

Suspension constraint: suspension deflection is evaluated between $[0 - 20]$ Hz by z_{def}/z_r .

In each case, one wish to perform better wrt. a passive suspension does. Therefore, to evaluate the control approach exposed thereafter wrt. the passive one, we introduce the power spectral density (PSD) measure of each of these signals on the frequency and amplitude space of interest by the use of the following formula:

$$I_{\{f_1, a_1\} \rightarrow \{f_2, a_2\}}(x) = \sqrt{\int_{f_1}^{f_2} \int_{a_1}^{a_2} x^2(f, a) da \cdot df} \quad (3)$$

where f_1 and f_2 (resp. a_1 , a_2) are the lower and higher frequency (resp. amplitude) bounds respectively and x is the signal of interest. The frequency response ($x(f, a)$) of the nonlinear system is evaluated assuming a sinusoidal input z_r of varying magnitude (1 – 8cm) for 10 periods (with varying frequency). Then a discrete Fourier Transform is performed to evaluate the system gain.

4.2 Semi-active proposed approach

To ensure the semi-activeness of the controller output, the static damper model D given in Section 3 is used in the LPV controller; the computed control force u provided by the controller is compared with the possible reachable one v (Figure 6). The controller is scheduled according to this difference (as the anti-windup does with the integral action) as:

$$\begin{cases} |u - v| = 0 \Rightarrow \text{semi-active control } (u^{\mathcal{H}_\infty} \neq 0) \\ |u - v| > \varepsilon \Rightarrow \text{nominal control } (u^{\mathcal{H}_\infty} = 0) \end{cases}$$

where ε is chosen sufficiently small ($\simeq 10^{-4}$) to ensure the semi-active control. $|u - v| \neq 0$ means that the required force is outside the allowed range, then the "passive control" is chosen ($u^{\mathcal{H}_\infty} = 0 \Leftrightarrow u = -c(\dot{z}_{def})$). To incorporate this strategy in the framework of a LPV design, we introduce a parameter ρ with the following choice:

$$\begin{cases} |u - v| = 0 \Rightarrow \rho \text{ low} \\ |u - v| > \varepsilon \Rightarrow \rho \text{ high} \end{cases}$$

With this strategy, we can find a controller $S(\rho)$ that can either satisfy some performance objectives or be passive (when no control law can be applied because of actuator limitations). The generalized block scheme incorporating the weighting functions is given on Figure 6, where ρ is the scheduling parameter that will be used to satisfy the dissipative damper constraints.

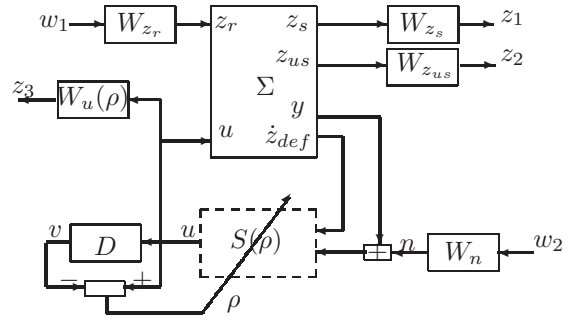

Fig. 6. General block diagram.

4.3 LPV design & Scheduling strategy

As described on Figure 6, the ρ parameter appears in the $W_u(\rho)$ weight function. Through the LPV design, $W_u(\rho)$ is varying between an upper and a lower bound. Let remember that in the \mathcal{H}_∞ framework this weight indicates how large the gain on the control signal can be. Choosing a high $W_u(\rho) = \rho$ forces the control signal to be low, and conversely. Hence, when ρ is large, the control signal is so penalized that it is practically zero, and the closed-loop behavior is the same as the passive quarter vehicle model one. Conversely, when ρ is small, the control signal is no more penalized, hence the controller acts as an active controller and can achieve performances. Let consider the generalize plant description,

$$\begin{bmatrix} \dot{x} \\ z_\infty \\ y \end{bmatrix} = \begin{bmatrix} A(\rho) & B_\infty(\rho) & B \\ C_\infty(\rho) & D_{\infty u}(\rho) & D_{\infty u} \\ C & 0 & 0 \end{bmatrix} \begin{bmatrix} x \\ w_\infty \\ u \end{bmatrix} \quad (4)$$

where, $x = [x_{quarter} \ x_{weights}]^T$ represents the states of the linearized quarter vehicle model (obtained thanks to equation 1) and the weight states, $z_\infty = [W_{z_s} z_s \ W_{z_{us}} z_{us} \ W_u u]^T$ the performance signals, $w_\infty = [W_{z_r}^{-1} z_r \ W_n^{-1} n]^T$ the weighted input signals, $y = z_{def}$ the measurement and $\rho \in [\underline{\rho} \ \bar{\rho}]$ the varying parameter. The weighting functions are given by: $W_{z_s} = 2 \frac{2\pi f_1}{(s+2\pi f_1)}$, $W_{z_{us}} = \frac{2\pi f_2}{(s+2\pi f_2)}$, $W_{z_r} = 7.10^{-2}$, $W_n = 10^{-4}$ and $W_u(\rho) \in \rho = [0.1 \ 10]$. W_{z_s} (resp. $W_{z_{us}}$) is shaped according to performance specifications, W_{z_r} and W_n model ground disturbances (z_r) and measurement noise (n) respectively, and $W_u(\rho)$ is used to limit the control signal and achieve the semi-active constraint. $f_1 = 3$ Hz and $f_2 = 5$ Hz.

To find the LPV/ \mathcal{H}_∞ controller, we solve at each vertex of the polytope formed by $co\{\underline{\rho}, \bar{\rho}\}$, the bounded real lemma (using a common parameter independent Lyapunov function):

$$\begin{bmatrix} A(\rho)^T K + K A(\rho) & K B(\rho) & C(\rho)^T \\ B(\rho)^T K & -\gamma_\infty^2 I & D(\rho)^T \\ C(\rho) & D(\rho) & -I \end{bmatrix} < 0 \quad (5)$$

Because of the ρ parameter, (5) is an infinite set Bilinear Matrix Inequality (BMI), hence a non-convex problem has to be solved. Via a change of basis expressed in (Scherer *et al.* 1997), extended to polytopic systems, we can find a non-conservative LMI that expresses the same problem in a tractable way for Semi-Definite Programs (SDP). As the parameter dependency enters in a linear way in the system definition, the polytopic approach is used (see e.g. Zin *et al.* 2006).

It leads to two controllers $S(\rho)$ and $S(\bar{\rho})$, hence two closed-loop ($CL(\rho)$ and $CL(\bar{\rho})$). Then, the applied control law is a convex combination of these two controllers. Hence, controller $S(\rho)$ and closed-loop $CL(\rho)$ can be expressed as the following convex hull: $co\{S(\rho), S(\bar{\rho})\} \Leftrightarrow co\{S_1, S_0\}$ and $co\{CL(\rho), CL(\bar{\rho})\} \Leftrightarrow co\{CL_1, CL_0\}$. Note that a major interest in using the LPV design is that it ensures the internal stability of the closed-loop system for all $\rho \in [\underline{\rho}, \bar{\rho}]$.

5. SIMULATION & VALIDATION

5.1 Performance evaluation & Frequency behavior

On Figures 7 and 8 we plot the frequency response z_s/z_r and z_{us}/z_r , of the passive and controlled quarter car.

Both show frequency responses and PSD show improvements of the proposed approach. Then, applying PSD criteria (3) on both passive and controlled nonlinear quarter car model leads to the results summarized on Table 1 where the improvement is evaluated as: (Passive PSD – Controlled PSD)/Passive PSD.

Signal	Passive PSD	Controlled PSD	Gain [%]
\ddot{z}_s/z_r	280	206	25.4%
z_s/z_r	2.4	2.1	12.1%
z_{us}/z_r	1.3	1.2	7%
z_{def}/z_r	1.5	1.4	8.02%

Table 1. Passive vs. Controlled PSD.

Note that the passive reference model is a "Renault Mégane Coupé", which is known to be a good road holding car. Nevertheless, the proposed semi-active control shows to improve the comfort without deteriorating the road holding.

5.2 Time simulation results

To validate the approach and check weather the semi-active constraint is fulfilled, a step road disturbance ($z_r = 3\text{cm}$) is generated on both passive and controlled system. This leads to the Force-Deflection speed space and chassis displacement given on Figure 9 and 10.

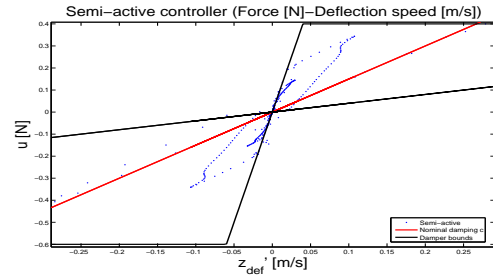

Fig. 9. LPV/ \mathcal{H}_∞ semi-active controller (dot), nominal damping & saturation force (solid).

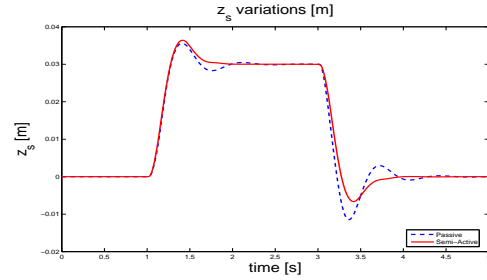

Fig. 10. Chassis displacement for passive (dashed) and LPV/ \mathcal{H}_∞ semi-active (solid) suspension.

With this representation it is clear that the proposed LPV controller provides a force that fulfills the dissipative inherent constraint of the controlled damper keeping a good chassis behavior. It also appears that this strategy does not only satisfy the semi-active constraint, but also the actuator limitations.

6. CONCLUSION AND FUTURE WORKS

In this article, we introduce a new strategy to ensure the dissipative constraint for a semi-active suspension keeping the advantages of the \mathcal{H}_∞ control design. Interests of such approach compared to existing ones are:

Flexible design: possibility to apply \mathcal{H}_∞ , \mathcal{H}_2 , Pole placement, Mixed etc. criterion

Measurement: only the suspension deflection sensor is required

Computation: synthesis leads to two LTI controllers & simple scheduling strategy (no on-line optimization process involved)

Robustness: internal stability & robustness

Hence the new semi-active strategy exhibits significant improvements on the achieved performances. Moreover, implementation of such a controller results in a cheap solution. In future works we aim to implement such algorithm on a suspension.

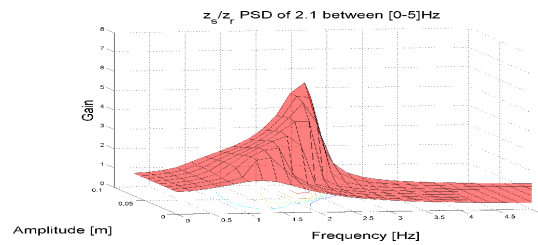
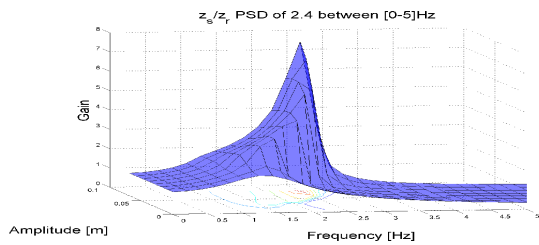

Fig. 7. Freq. resp. of z_s/z_r for the passive (left) and controlled (right) nonlinear quarter vehicle.

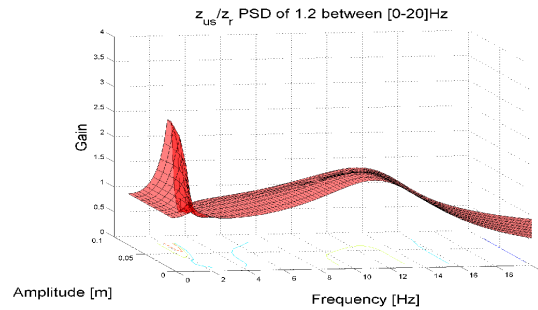
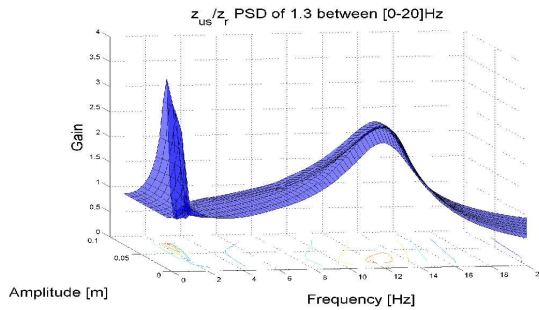

Fig. 8. Freq. resp. of z_{us}/z_r for the passive (left) and controlled (right) nonlinear quarter vehicle.

REFERENCES

- Canale, M., M. Milanese and C. Novara (2006). Semi-active suspension control using fast model-predictive techniques. *IEEE Transaction on Control System Technology* **14**(6), 1034–1046.
- Du, H., K. Yim Sze and J. Lam (2005). Semi-active \mathcal{H}_∞ control with magneto-rheological dampers. *Journal of Sound and Vibration* **283**(3-5), 981–996.
- Fialho, I. and G. Balas (2002). Road adaptive active suspension design using linear parameter varying gain scheduling. *IEEE Transaction on Control System Technology* **10**(1), 43–54.
- Gáspár, P., I. Szaszi and J. Bokor (1998). Iterative model-based mixed $\mathcal{H}_2/\mathcal{H}_\infty$ control design. In: *Proceedings of the UKACC International Conference on Control*. Swansea, United Kingdom. pp. 652–657.
- Gáspár, P., I. Szaszi and J. Bokor (2004). Active suspension design using LPV control. In: *Proceedings of the 1st IFAC Symposium on Advances in Automotive Control (AAC)*. Salerno, Italy. pp. 584–589.
- Giorgetti, N., A. Bemporad, H.E. Tseng and D. Hrovat (2006). Hybrid model predictive control application toward optimal semi-active suspension. *International Journal of Control* **79**(5), 521–533.
- Hrovat, D. (1997). Survey of advanced suspension developments and related optimal control application. *Automatica* **33**(10), 1781–1817.
- Lu, J. and M. DePoyster (2002). Multiobjective optimal suspension control to achieve integrated ride and handling performance. *IEEE Transaction on Control System Technology* **10**(6), 807–821.
- Nino, E., R. Ramirez-Mendoza and D. Guerre (2006). Applying black box model in the identification of mr damper. In: *Proceedings of the 10th Mechatronics Forum Biennial*. Malvern, Pennsylvania.
- Poussot-Vassal, C., O. Sename, L. Dugard, R. Ramirez-Mendoza and L. Flores (2006). Optimal skyhook control for semi-active suspensions. In: *Proceedings of the 4th IFAC Symposium on Mechatronics Systems*. Heidelberg, Germany. pp. 608–613.
- Rossi, C. and G. Lucente (2004). \mathcal{H}_∞ control of automotive semi-active suspensions. In: *Proceedings of the 1st IFAC Symposium on Advances in Automotive Control (AAC)*. Salerno, Italy.
- Sammier, D., O. Sename and L. Dugard (2003). Skyhook and \mathcal{H}_∞ control of active vehicle suspensions: some practical aspects. *Vehicle System Dynamics* **39**(4), 279–308.
- Scherer, C., P. Gahinet and M. Chilali (1997). Multiobjective output-feedback control via LMI optimization. *IEEE Transaction on Automatic Control* **42**(7), 896–911.
- Takahashi, R.H.C., J.F. Camino, D.E. Zampieri and P.L.D. Peres (1998). A multiobjective approach for \mathcal{H}_2 and \mathcal{H}_∞ active suspension control. In: *Proceedings of the IEEE American Control Conference (ACC)*. Philadelphia, Pennsylvania. pp. 48–52.
- Zin, A., O. Sename, P. Gáspár, L. Dugard and J. Bokor (2006). An LPV/ \mathcal{H}_∞ active suspension control for global chassis technology: Design and performance analysis. In: *Proceedings of the IEEE American Control Conference (ACC)*. Minneapolis, Minnesota.