



**HAL**  
open science

## On Compatible Normal Odd Partitions in Cubic Graphs

Jean-Luc Fouquet, Jean-Marie Vanherpe

► **To cite this version:**

Jean-Luc Fouquet, Jean-Marie Vanherpe. On Compatible Normal Odd Partitions in Cubic Graphs. Journal of Graph Theory, 2013, 72 (4), pp.410-461. 10.1002/jgt21652 . hal-00144319v2

**HAL Id: hal-00144319**

**<https://hal.science/hal-00144319v2>**

Submitted on 27 Jan 2012

**HAL** is a multi-disciplinary open access archive for the deposit and dissemination of scientific research documents, whether they are published or not. The documents may come from teaching and research institutions in France or abroad, or from public or private research centers.

L'archive ouverte pluridisciplinaire **HAL**, est destinée au dépôt et à la diffusion de documents scientifiques de niveau recherche, publiés ou non, émanant des établissements d'enseignement et de recherche français ou étrangers, des laboratoires publics ou privés.

# On Compatible Normal Odd Partitions in Cubic Graphs

J.L. Fouquet

L.I.F.O., Faculté des Sciences, B.P. 6759  
Université d'Orléans, 45067 Orléans Cedex 2, FR \*

J.M. Vanherpe

L.I.F.O., Faculté des Sciences, B.P. 6759  
Université d'Orléans, 45067 Orléans Cedex 2, FR<sup>†</sup>

January 27, 2012

## Abstract

A *normal odd partition*  $\mathcal{T}$  of the edges of a cubic graph is a partition into *trails* of odd length (no repeated edge) such that each vertex is the end vertex of exactly one trail of the partition and internal in some trail. For each vertex  $v$ , we can distinguish the edge for which this vertex is pending. Three normal odd partitions are compatible whenever these distinguished edges are distinct for each vertex. We examine this notion and show that a cubic 3-edge-colorable graph can always be provided with three compatible normal odd partitions. The Petersen graph has this property and we can construct other cubic graphs with chromatic index four with the same property. Finally, we propose a new conjecture which, if true, would imply the well known Fan and Raspaud Conjecture.

Keywords: Cubic graph; Edge-partition

## 1 Introduction

For basic graph-theoretic terms, we refer the reader to Bondy and Murty [1]. A *walk* in a graph  $G$  is a sequence  $W = v_0 e_1 v_1 \dots e_k v_k$ , where  $v_0, v_1, \dots, v_k$  are vertices of  $G$ , and  $e_1, e_2, \dots, e_k$  are edges of  $G$  and  $v_{i-1}$  and  $v_i$  are the ends of  $e_i$ ,  $1 \leq i \leq k$ . The vertices  $v_0$  and  $v_k$  are the *end vertices* and  $e_1$  and  $e_k$  are the *end edges* of this walk while  $v_1, \dots, v_{k-1}$  are the *internal vertices* and  $e_2, \dots, e_{k-1}$  are the *internal edges*. The *length*  $l(W)$  of  $W$  is the number of edges (namely  $k$ ). The walk  $W$  is *odd* whenever  $k$  is odd, *even* otherwise.

---

\*email: jean-luc.fouquet@univ-orleans.fr

†email: jean-marie.vanherpe@univ-orleans.fr

The walk  $W$  is a *trail* if its edges  $e_1, e_2, \dots, e_k$  are distinct and a *path* if its vertices  $v_0, v_1, \dots, v_k$  are distinct. If  $W = v_0 e_1 v_1 \dots e_k v_k$  is a walk of  $G$ , then  $W' = v_i e_{i+1} \dots e_j v_j$  ( $0 \leq i \leq j \leq k$ ) is a *subwalk* of  $W$  (*subtrails* and *subpaths* are defined analogously).

If  $v$  is an internal vertex of a walk  $W$  with ends  $x$  and  $y$ , then  $W(x, v)$  and  $W(v, y)$  are the subwalks of  $W$  obtained by cutting  $W$  at  $v$ . Conversely if  $W_1$  and  $W_2$  have precisely one common end  $v$ , then the *concatenation* of these two walks *at*  $v$  gives rise to a new walk (denoted by  $W_1 + W_2$ ) with  $v$  as an internal vertex. When there is no possible confusion as to the edges being used, it would be convenient to omit the edges in the description of a walk, i.e.,  $W = v_0 e_1 v_1 \dots e_k v_k$  can be shortened to  $W = v_0 v_1 \dots v_k$ .

In what follows,  $G$  is a cubic graph on  $n$  vertices where loops and multiple edges are allowed.

**Definition 1** A partition of  $E(G)$  into trails  $\mathcal{T} = \{T_1, T_2, \dots, T_k\}$  is *normal* when every vertex is an internal vertex of some trail of  $\mathcal{T}$ , say  $T_i$ ,  $i \in \{1, \dots, k\}$  and an end vertex in  $T_j \in \mathcal{T}$ ,  $j \in \{1, \dots, k\}$ . The *length* of a normal partition is the maximum length of the trails in the partition, that is  $\max\{l(T_i) | T_i \in \mathcal{T}\}$ .

If  $\mathcal{T} = \{T_1, T_2, \dots, T_k\}$  is a normal partition, then  $k = \frac{n}{2}$ . We can associate to each vertex  $v$  the unique edge with end  $v$  that is the end edge of a trail of  $\mathcal{T}$ . We shall denote this edge by  $e_{\mathcal{T}}(v)$  and it will be convenient to say that  $e_{\mathcal{T}}(v)$  is the *marked* edge associated to  $v$ . When it is necessary to illustrate our purpose by a figure, we represent the marked edge associated to a vertex by a  $\vdash$  close to this vertex.

Let  $v$  be a vertex such that  $v$  is an internal vertex in  $T_i \in \mathcal{T}$  and an end vertex in  $T_j \in \mathcal{T}$  (as an end of  $e_{\mathcal{T}}(v)$ ). We can associate to  $v$  the set  $E_{\mathcal{T}}(v)$  containing the end vertices of  $T_i$ . Note that  $T_i$  and  $T_j$  are not necessarily distinct, in this case we have  $v \in E_{\mathcal{T}}(v)$ . When  $x$  and  $y$  are the ends of  $T_i$ , one of these two vertices is certainly different from  $v$ . Let us transform  $\mathcal{T}$  into a new normal partition  $\mathcal{T}'$  by the so called *switching* operation (see Definition 2).

**Definition 2** Let  $\mathcal{T}$  be a normal partition and  $v$  be a vertex of the graph such that  $v$  is an internal vertex in  $T_i \in \mathcal{T}$  and an end vertex in  $T_j \in \mathcal{T}$ . Let  $x$  and  $y$  be the ends of  $T_i$ , ( $x \neq v$ ).

- When  $T_i \neq T_j$ , let  $T'_i = T_i(x, v) + T_j$ ,  $T'_j = T_i(y, v)$  and  $\mathcal{T}' = \mathcal{T} - \{T_i, T_j\} \cup \{T'_i, T'_j\}$ .
- When  $T_i = T_j$ , let us write  $T_i = x_0 e_0 x_1 e_1 \dots x_r e_r x_{r+1} \dots x_s e_s x_{s+1}$  where  $x_0 = x$ ,  $x_r = v$ ,  $e_s = e_{\mathcal{T}}(v)$  and  $x_{s+1} = v$ . We set  $T'_i = x_0 e_0 x_1 e_1 \dots x_r e_s x_s \dots x_{r+1} e_r x_r$  and  $\mathcal{T}' = \mathcal{T} - \{T_i\} \cup \{T'_i\}$  (see Figure 1).

The normal partition  $\mathcal{T}'$  is the result of the *switch* of  $\mathcal{T}$  on  $v$ .

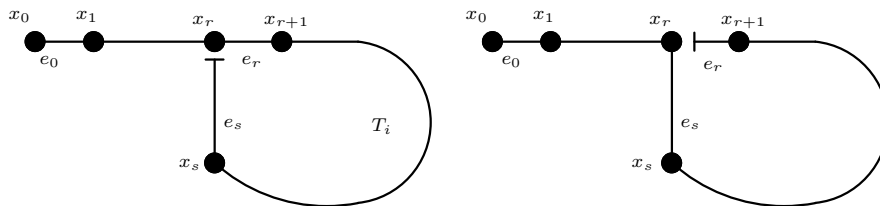

Figure 1: The switching operation when  $T_i = T_j$ .

**Definition 3** A normal partition  $\mathcal{T} = \{T_1, T_2, \dots, T_{\frac{n}{2}}\}$  of  $E(G)$  into trails is *odd* when every trail in  $\mathcal{T}$  is odd. For each trail of odd length  $T_i \in \mathcal{T}$ , let us say that an edge  $e$  of  $T_i$  is *odd* whenever the subtrails of  $T_i$  obtained by deleting  $e$  have odd lengths. The edges of  $T_i$  that are not odd are said to be *even*.

Given two normal partitions  $\mathcal{T} = \{T_1, T_2, \dots, T_{\frac{n}{2}}\}$  and  $\mathcal{T}' = \{T'_1, T'_2, \dots, T'_{\frac{n}{2}}\}$ ,  $A_{\mathcal{T}\mathcal{T}'}$  is the set of vertices such that  $e_{\mathcal{T}}(v) = e_{\mathcal{T}'}(v)$ . It must be clear that two normal partitions  $\mathcal{T}$  and  $\mathcal{T}'$  are identical whenever  $A_{\mathcal{T}\mathcal{T}'} = V(G)$ .

**Definition 4** Two normal partitions  $\mathcal{T}$  and  $\mathcal{T}'$  of  $E(G)$  into trails are *compatible* when  $e_{\mathcal{T}}(v) \neq e_{\mathcal{T}'}(v)$  for every vertex  $v$  of  $G$  (in other words  $A_{\mathcal{T}\mathcal{T}'} = \emptyset$ ).

Given three normal partitions  $\mathcal{T} = \{T_1, T_2, \dots, T_{\frac{n}{2}}\}$ ,  $\mathcal{T}' = \{T'_1, T'_2, \dots, T'_{\frac{n}{2}}\}$  and  $\mathcal{T}'' = \{T''_1, T''_2, \dots, T''_{\frac{n}{2}}\}$  we let  $A(\mathcal{T}, \mathcal{T}', \mathcal{T}'') = A_{\mathcal{T}\mathcal{T}'} \cup A_{\mathcal{T}'\mathcal{T}''} \cup A_{\mathcal{T}\mathcal{T}''}$ . We say that  $G$  has three compatible normal odd partitions  $\mathcal{T}$ ,  $\mathcal{T}'$  and  $\mathcal{T}''$  whenever these partitions are pairwise compatible, that is  $A(\mathcal{T}, \mathcal{T}', \mathcal{T}'') = \emptyset$ .

It is shown in [3] (see Theorem 5) that a cubic graph without loops can always be provided with three compatible normal partitions.

**Theorem 5** [3] *A cubic graph  $G$  has three compatible normal partitions if and only if  $G$  has no loop.*

Normal odd partitions are directly associated to perfect matchings and it is natural to ask whether the problem of finding three compatible normal odd partitions is connected to the edge-coloring problem. We show that cubic graphs with chromatic index 3 can be provided with three compatible normal odd partitions. It turns out that the Petersen graph, the Flower snarks, and the Goldberg snarks have also three such partitions.

## 2 Preliminary results

### 2.1 Switching equivalence

In [3] we proved that if  $\mathcal{T}$  and  $\mathcal{T}'$  are two normal partitions of a cubic graph then we can transform  $\mathcal{T}$  into  $\mathcal{T}'$  by a sequence of at most  $2n$  switchings. In other words  $\mathcal{T}$  and  $\mathcal{T}'$  are *switching equivalent*.

When  $\mathcal{T}$  is a normal odd partition, a switching leading to a new odd partition  $\mathcal{T}'$  is said to be an *odd switching*. When we can transform a normal odd partition  $\mathcal{T}$  in  $\mathcal{T}'$  by a sequence of odd switching operations,  $\mathcal{T}$  and  $\mathcal{T}'$  are said to be *odd switching equivalent*.

**Theorem 6** *Any two normal odd partitions of a cubic graph  $G$  are odd switching equivalent.*

**Proof** Let  $M_{\mathcal{T}}(v)$  denote the set of edges  $x$  incident with a vertex  $v$  for which there exists a normal odd partition  $\mathcal{T}$  of  $G$  odd switching equivalent with  $\mathcal{T}$ , such that  $x = e_{\mathcal{T}}(v)$  and  $e_{\mathcal{T}}(u) = e_{\mathcal{T}'}(u)$  for all  $u, v$  such that  $u \neq v$ .

If  $\mathcal{T}$  is a normal odd partition of a cubic graph  $G$ , then for every vertex  $v$  of  $G$  there exists a normal odd partition  $\mathcal{T}'$  of  $G$  such that  $e_{\mathcal{T}}(v) \neq e_{\mathcal{T}'}(v)$  and  $e_{\mathcal{T}}(u) = e_{\mathcal{T}'}(u)$  for all  $u$  and  $v$  such that  $u \neq v$ ,  $\mathcal{T}$ , and  $\mathcal{T}'$  are odd switching equivalent. Therefore,  $|M_{\mathcal{T}}(v)| \geq 2$  for every  $v$ .

Assume that  $\mathcal{T}$  and  $\mathcal{T}'$  are normal odd partitions of  $G$  that are not odd switching equivalent and such that  $A_{\mathcal{T}\mathcal{T}'}$  has maximum cardinality. Then there is a vertex  $v \notin A_{\mathcal{T}\mathcal{T}'}$ . Since  $|M_{\mathcal{T}}(v)| \geq 2$  and  $|M_{\mathcal{T}'}(v)| \geq 2$ , we have  $M_{\mathcal{T}}(v) \cap M_{\mathcal{T}'}(v) \neq \emptyset$ . Therefore, there exist two normal odd partitions  $\mathcal{S}$  and  $\mathcal{S}'$  of  $G$  that are not odd switching equivalent and  $A_{\mathcal{T}\mathcal{T}'} \subsetneq A_{\mathcal{S}\mathcal{S}'}$ , a contradiction.  $\square$

**Theorem 7** *Let  $G$  be a cubic graph. Then  $G$  has an odd normal partition if and only if  $G$  has a perfect matching.*

**Proof** If  $M$  is a perfect matching of  $G$ , then  $G - M$  is a 2-factor of  $G$ . Let us give an orientation to this 2-factor and for each vertex  $v$  let us denote the outgoing edge  $o(v)$ . For each edge  $e$  such that  $e = uv \in M$ , let  $P_{uv}$  be the path of length 3 obtained by concatenating  $o(u)$ ,  $uv$  and  $o(v)$ . Then  $T = \{P_{uv} | uv \in M\}$  is a normal odd partition (of length 3) of  $G$ . Conversely let  $\mathcal{T} = \{T_1, T_2, \dots, T_{\frac{n}{2}}\}$  be a normal odd partition of  $G$ . A vertex  $v \in V(G)$  is internal in exactly one trail of  $\mathcal{T}$ . The edges of this trail being alternately odd and even,  $v$  is incident to exactly one odd edge. Hence the odd edges defined above induce a perfect matching of  $G$ .  $\square$

Given an odd normal partition  $\mathcal{T}$  of  $G$ , we can define the *associated* perfect matching as the set of odd edges of  $\mathcal{T}$ . Conversely, given a perfect matching  $M$ , we can say that a normal odd partition  $\mathcal{T}$  is *conformal* to  $M$  whenever  $M$  is the set of odd edges of  $\mathcal{T}$ . Let  $\mathcal{T}'$  be a normal odd partition obtained from a normal odd partition  $\mathcal{T}$  by one operation of switching. If  $\mathcal{T}$  and  $\mathcal{T}'$  are conformal to a perfect matching  $M$ , then we can say that we have performed a *conformal (to  $M$ ) switching*. This operation of conformal switching is not always possible on a vertex. Indeed, assuming that  $v$  is an internal vertex in  $T \in \mathcal{T}$  and an end vertex of this trail, then the conformal switching is not allowed since we would obtain a cycle in the transformation (see Figure 2, the edge of  $M$  is the dashed edge).

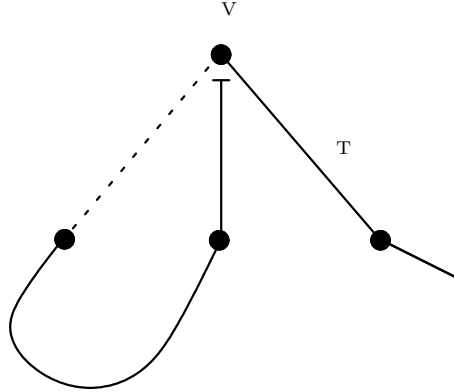

Figure 2: Conformal switching on  $v$  not allowed (the dashed edge is odd).

**Theorem 8** *If  $G$  is a cubic graph of order at least four and  $M$  is a perfect matching in  $G$ , then any two normal odd partitions  $\mathcal{T}$  and  $\mathcal{T}'$  conformal to  $M$  are conformal switching equivalent.*

**Proof** Assume that  $\mathcal{T}$  and  $\mathcal{T}'$  are two normal odd partitions conformal to a perfect matching  $M$  that does not belong to the same equivalence class. Suppose that  $|A_{\mathcal{T}\mathcal{T}'}|$  is maximum. In particular, we have  $A_{\mathcal{T}\mathcal{T}'} \neq V(G)$ .

Let  $v \notin A_{\mathcal{T}\mathcal{T}'}$  and let  $u_1, u_2$ , and  $u_3$  be its neighbors. Put  $vu_1 = e_1, vu_2 = e_2$ , and  $vu_3 = e_3$ . Without loss of generality we may assume that  $vu_1$  is an edge of  $M$  and that  $e_{\mathcal{T}}(v) = vu_2$ , while  $e_{\mathcal{T}'}(v) = vu_3$ . Since a conformal switching of  $\mathcal{T}$  on  $v$  leads to a conformal normal partition  $\mathcal{T}''$  where  $e_{\mathcal{T}''}(v) = e_{\mathcal{T}'}(v)$  while nothing is changed elsewhere, we can suppose that this conformal switching is not allowed on  $v$ . In the same way a conformal switching of  $\mathcal{T}'$  on  $v$  is not allowed as well. Hence  $v$  is an internal vertex of  $T \in \mathcal{T}$  and an end vertex of this trail. Symmetrically,  $v$  is an internal vertex of  $T' \in \mathcal{T}'$  and an end vertex of this trail (see Figure 3). We suppose that  $y$  is the second end vertex of  $T$  and  $y'$  the second end vertex of  $T'$ .

**Claim 1** *The vertices  $u_2$  and  $u_3$  are distinct.*

**Proof** If  $u_2 = u_3$ , then we have  $e_{\mathcal{T}}(u_3) = e_3$  (formally we need to distinguish between  $u_2$  and  $u_3$ ) and  $e_{\mathcal{T}'}(u_2) = e_2$ . Hence  $u_2 \notin A_{\mathcal{T}\mathcal{T}'}$ . Let us denote by  $u_2u_4$  the edge of  $M$  incident to  $u_2 (= u_3)$  on the subtrail of  $\mathcal{T}$  joining  $u_1$  to  $u_2$ .

We may assume that  $u_4 \neq u_1$ , otherwise  $G$  would be a graph on two vertices, a contradiction.

But now, conformal switchings of  $\mathcal{T}$  on  $u_4, u_2$ , and  $v$  lead to a normal partition  $\mathcal{T}''$  conformal switching equivalent to  $\mathcal{T}$ . Whether  $u_4$  belongs or not to  $A_{\mathcal{T}\mathcal{T}'}$ ,  $A_{\mathcal{T}''\mathcal{T}'}$  has more vertices than  $A_{\mathcal{T}\mathcal{T}'}$ , a contradiction. ■

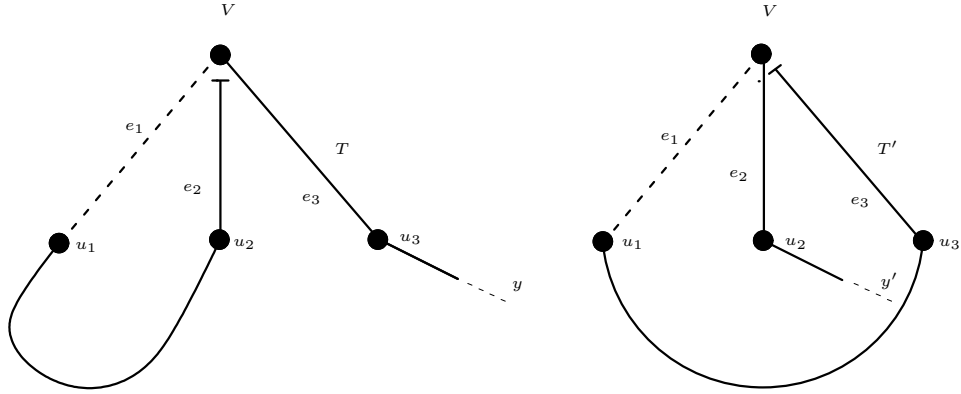

Figure 3: Conformal switchings on  $v$  are not allowed in  $\mathcal{T}$  and  $\mathcal{T}'$  (the dashed edges are odd).

**Claim 2** *The vertices  $u_1$  and  $u_2$  are distinct.*

**Proof** Assume not: thus  $u_1 \notin A_{\mathcal{T}\mathcal{T}'}$ . From Claim 1, we then have  $u_1 \neq u_3$ .

We have  $y = u_1$ , otherwise we could transform  $\mathcal{T}$  to  $\mathcal{T}''$  by using a conformal switching on  $u_1$  followed by a conformal switching on  $v$  and we would obtain  $|A_{\mathcal{T}''\mathcal{T}'}| > |A_{\mathcal{T}\mathcal{T}'}|$ , a contradiction.

But now, conformal switchings of  $\mathcal{T}$  on  $u_3$ ,  $u_1$ , and  $v$  lead to a normal partition  $\mathcal{T}''$  conformal switching equivalent to  $\mathcal{T}$ . Whether  $u_3$  belongs or not to  $A_{\mathcal{T}\mathcal{T}'}$ ,  $A_{\mathcal{T}''\mathcal{T}'}$  has more vertices than  $A_{\mathcal{T}\mathcal{T}'}$ , a contradiction. ■

Similarly  $u_1 \neq u_3$ . Consider the subtrails  $T(u_1, u_2)$ . There is a certainly a vertex on that trail for which the associated marked edge  $e_{\mathcal{T}}(w) \neq e_{\mathcal{T}'}(w)$ . Assume that  $w$  is the first such vertex when running from  $u_1$  to  $u_2$  on  $T$  (let us remark that  $T(u_1, w) = T'(u_1, w)$ ). Hence  $w \notin A_{\mathcal{T}\mathcal{T}'}$ . Let  $x$  be the neighboring vertex of  $w$  on  $T(v, w)$  (it may happen that  $u_1 = w$ , in which case  $x = v$ ) and let  $Q$  be the trail of  $\mathcal{T}$  ending in  $w$  with the marked edge  $e_{\mathcal{T}}(w)$ .

Since  $e_{\mathcal{T}}(w) \notin M$  and  $e_{\mathcal{T}'}(w) \notin M$ , we have  $xw \in M$ .

**Claim 3**  $w = y$ .

**Proof** Assume that  $w \neq y$ . Since  $xw \in M$ , we can perform a conformal switching of  $\mathcal{T}$  on  $w$  leading to the conformal partition  $\mathcal{T}''$ :

$$\mathcal{T}'' = \mathcal{T} - \{T, Q\} + \{T(y, w) + Q, T(w, v)\}$$

But now,  $|A_{\mathcal{T}\mathcal{T}''}| > |A_{\mathcal{T}\mathcal{T}'}|$ , a contradiction. ■

In the same way, we certainly have  $w = y'$  (take  $\mathcal{T}'$  instead of  $\mathcal{T}$ ). Since by Claim 1  $u_2 \neq u_3$ , we must have either  $u_2 \neq w$  or  $u_3 \neq w$ . By considering  $\mathcal{T}$ , we



Figure 4: Two non-equivalent conformal partitions for the cubic graph on two vertices (the dashed edges are odd).

can decide without loss of generality that  $u_2 \neq w$  (if not, we consider  $\mathcal{T}'$  where the roles of  $u_2$  and  $u_3$  are exchanged).

In  $\mathcal{T}$ , the vertex  $u_2$  is an internal vertex of  $T$  and an end vertex of a trail  $S$  with  $S \neq T$ . A conformal switching is allowed on  $u_2$  and this switching leads to the conformal partition

$$\mathcal{Q} = \mathcal{T} - \{T, S\} + \{T(y, u_2) + S, u_2v\}.$$

We have  $A_{\mathcal{Q}\mathcal{T}'} = A_{\mathcal{T}\mathcal{T}'}$  or  $A_{\mathcal{Q}\mathcal{T}'} = A_{\mathcal{T}\mathcal{T}'} - u_2$ . But now we can perform a conformal switching on  $v$  followed by a conformal switching on  $w$ . The first switching on  $v$  leads to  $\mathcal{R}$  defined as follows:

$$\mathcal{R} = \mathcal{Q} - \{T(y, u_2) + S, vu_2\} + \{S + T(u_2, v) + vu_2, T(v, w)\}.$$

The second switching on  $w$  leads to  $\mathcal{S}$  defined by

$$\mathcal{S} = \mathcal{R} - \{S + T(u_2, v) + vu_2, T(v, w)\} + \{u_2v + T(v, w) + T(w, v), T(w, u_2) + S\}.$$

We have now  $v$  and  $w$  in  $A_{\mathcal{S}\mathcal{T}'}$ . Since this set has at least one vertex more than  $A_{\mathcal{T}\mathcal{T}'}$ , we have a contradiction.  $\square$

It turns out that the cubic graph on two vertices depicted in Figure 4 has two non-equivalent conformal partitions (with respect to the dashed edge).

## 2.2 Miscellaneous

The following proposition will be essential in the next section.

**Proposition 9** *Let  $G$  be a cubic graph having three normal partitions  $\mathcal{T}$ ,  $\mathcal{T}'$  and  $\mathcal{T}''$ . If  $e = xy$  is an edge of  $G$  such that  $x$  and  $y$  are not in  $A(\mathcal{T}, \mathcal{T}', \mathcal{T}'')$ , then one of the followings is true:*

- $e$  is an internal edge in exactly one partition,
- $e$  is an internal edge in exactly two partitions.

*Moreover, in the second case, the edge  $e$  itself is a trail of the third partition.*

**Proof** Assume that  $e$  is an end edge in  $\mathcal{T}$ , in  $\mathcal{T}'$ , and in  $\mathcal{T}''$ . Then in  $x$  or  $y$  we would have two partitions (say  $\mathcal{T}$  and  $\mathcal{T}'$ ) for which  $e_{\mathcal{T}}(x) = e_{\mathcal{T}'}(x)$  ( $e_{\mathcal{T}}(y) = e_{\mathcal{T}'}(y)$  respectively), a contradiction.

If  $e$  is an internal edge in  $\mathcal{T}$ ,  $\mathcal{T}'$  and  $\mathcal{T}''$ , then let  $a$  and  $b$  be the two other neighbors of  $x$ . We would then have



- $e_{\mathcal{T}}(x) = xa$  or  $xb$
- $e_{\mathcal{T}'}(x) = xa$  or  $xb$
- $e_{\mathcal{T}''}(x) = xa$  or  $xb$ ,

which is impossible.

Assume now that  $e$  is an internal edge of a trail in  $\mathcal{T}$  and in  $\mathcal{T}'$  and let  $a$  and  $b$  be the two other neighbors of  $x$ . Up to the names of the vertices, we have

- $e_{\mathcal{T}}(x) = xa$
- $e_{\mathcal{T}'}(x) = xb$ .

>From the third partition  $\mathcal{T}''$ , we must have  $e_{\mathcal{T}''}(x) = xy$ . In the same way we would obtain  $e_{\mathcal{T}''}(y) = yx$ . Hence the trail containing  $e = xy$  is reduced to  $e$ , as claimed.  $\square$

Given a normal partition  $\mathcal{T}$ , the average length of the trails in  $\mathcal{T}$  is denoted  $\mu(\mathcal{T})$  while  $n_{\mathcal{T}}(i)$  is the number of trails of length  $i$ .

**Proposition 10** [3] *Let  $\mathcal{T}$  be a normal partition of a cubic graph  $G$  on  $n$  vertices. It follows that*

- $\mu(\mathcal{T}) = 3$ ,
- $\sum_{i=1}^{i=n+1} (3-i)n_{\mathcal{T}}(i) = 0$ .

Hence a normal partition whose average length is 3 has all its trails of length 3.

**Proposition 11** *If  $G$  is a cubic graph with three compatible normal odd partitions, then  $G$  is bridgeless.*

**Proof** Assume that  $xy$  is a bridge of  $G$  and let  $C$  be the component of  $G - xy$  containing  $x$ . Since  $G$  has three compatible normal odd partitions, one of these partitions, say  $\mathcal{T}$ , is such that  $e_{\mathcal{T}}(x) = xy$ . Thus the edges of  $C$  are partitioned into odd trails. We have

$$m = |E(C)| = \frac{3(|C| - 1) + 2}{2}$$

and  $m$  is even whenever  $|C| \equiv 3 \pmod{4}$  while  $m$  is odd whenever  $|C| \equiv 1 \pmod{4}$ . The trace of  $\mathcal{T}$  on  $C$  is a set of  $\frac{|C|-1}{2}$  trails and this number is odd when  $|C| \equiv 3 \pmod{4}$  and even otherwise. Hence when  $|C| \equiv 3 \pmod{4}$  we must have an odd number of odd trails partitioning  $E(C)$ , but in that case  $m$  is even, a contradiction. When  $|C| \equiv 1 \pmod{4}$ , we must have an even number of odd trails partitioning  $E(C)$ , but in that case  $m$  is odd, contradiction.  $\square$

In Figure 5, we show  $K_4$  provided with three compatible normal odd partitions. Let us remark that, following Theorem 12, we need to have trails of length 5 in at least one partition.

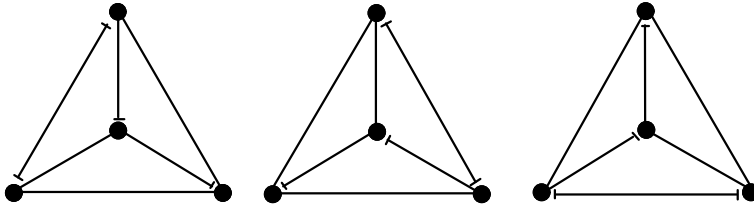

Figure 5:  $K_4$  with three compatible normal odd partitions.

### 3 On cubic graphs with chromatic index three

In this section the existence of three compatible normal odd partitions in cubic 3-edge-colorable graphs is considered.

**Theorem 12** *If  $G$  is a cubic graph, then the following are equivalent:*

- i)  $G$  has three compatible normal odd partitions of length 3
- ii)  $G$  has three compatible normal odd partitions, where each edge is an internal edge in exactly one partition
- iii)  $G$  is bipartite.

**Proof** Assume first that  $G$  can be provided with three compatible normal odd partitions of length 3, say  $\mathcal{T}$ ,  $\mathcal{T}'$ , and  $\mathcal{T}''$ . Since the average length of each partition is 3 (Proposition 10), each trail of each partition has length exactly 3. Thus  $\mathcal{T}$ ,  $\mathcal{T}'$ , and  $\mathcal{T}''$  are three normal odd partitions and from Proposition 9, each edge is the internal edge of one trail in exactly one partition. Conversely suppose that  $G$  can be provided with three compatible normal odd partitions where each edge is an internal edge in exactly one partition, the edge of each trail of length 1 must be an internal edge of two partitions, thus there is no trail of length 1 in any of these partitions. Since the average length of each partition is 3, that means that each trail in each partition has length exactly 3. Hence  $i) \equiv ii)$ .

We prove now that  $i) \equiv iii)$ . Let  $\mathcal{T}$ ,  $\mathcal{T}'$  and  $\mathcal{T}''$  be three compatible normal odd partitions of length 3. Following the proof of Theorem 7, the set of internal edges of trails of  $\mathcal{T}$  ( $\mathcal{T}'$  and  $\mathcal{T}''$  respectively) is a perfect matching, say  $M$  ( $M'$  and  $M''$  respectively).

Let  $a_0a_1a_2a_3$  be a trail of  $\mathcal{T}$  and let  $b_1$  and  $b_2$  be the third neighbors of  $a_1$  and  $a_2$  respectively. By definition, we have  $e_{\mathcal{T}}(a_1) = a_1b_1$  and  $e_{\mathcal{T}}(a_2) = a_2b_2$ .

Assume without loss of generality that  $a_0a_1$  is an internal edge of a trail  $T'_1$  of  $\mathcal{T}'$ . The trail  $T'_1$  does not use  $a_1a_2$ : otherwise  $e_{\mathcal{T}'}(a_1) = a_1b_1$ , a contradiction to  $e_{\mathcal{T}}(a_1) = a_1b_1$  since  $\mathcal{T}$  and  $\mathcal{T}'$  are compatible. Hence  $T'_1$  uses  $a_1b_1$  and  $e_{\mathcal{T}'}(a_1) = a_1a_2$ .

Assume now that  $a_2a_3$  is an internal edge of a trail  $T'_2$  of  $\mathcal{T}'$ . Reasoning in the same way, we get that  $e_{\mathcal{T}'}(a_2) = a_2a_1$ . These two results lead to the fact

that  $a_2a_3$  must be a trail in  $\mathcal{T}'$ , which is impossible since each trail has length exactly 3.

Hence  $a_2a_3$  is an internal edge in a trail of  $\mathcal{T}''$ . Thus the two internal vertices of  $a_0a_1a_2a_3$  can be distinguished, as follows from the fact that the end edge to which they are incident is internal in  $\mathcal{T}'$  (say *white* vertices) or  $\mathcal{T}''$  (say *black* vertices). The same holds for each trail in  $\mathcal{T}$  (and incidently for each partition  $\mathcal{T}'$  and  $\mathcal{T}''$ ). We can now remark that  $a_1b_1$  is an end edge of a trail in  $\mathcal{T}$ . This end edge cannot be an internal edge in  $\mathcal{T}'$  since the trail of length 3 going through  $a_0a_1$  ends with  $a_1b_1$ . Hence  $a_1b_1$  is an internal edge in  $\mathcal{T}''$  and  $b_1$  is a black vertex. Considering now  $a_0$ , this vertex is the internal vertex of a trail of length 3 of  $\mathcal{T}$ . Since  $a_0a_1 \in M'$  and  $M'$  is a perfect matching,  $a_0$  cannot be incident to an other internal edge of a trail in  $\mathcal{T}'$  and  $a_0$  must be a black vertex. Hence  $a_1$  is a white vertex and its neighbors are all black vertices. Since we can perform this reasoning for each vertex,  $G$  is bipartite as claimed.

Conversely, suppose that  $G$  is bipartite and let  $V(G) = \{W, B\}$  be the bipartition of its vertex set. In the following, a vertex in  $W$  will be represented by a circle ( $\circ$ ) while a vertex in  $B$  will be represented by a bullet ( $\bullet$ ). From König's Theorem [7],  $G$  is a cubic 3-edge-colorable graph. Let us consider a coloring of its edge set with three colors  $\{\alpha, \beta, \gamma\}$ . A trail of length 3 that is obtained by considering an edge  $uv$  ( $u \in B$  and  $v \in W$ ) colored with  $\beta$  together with the edge colored  $\alpha$  incident with  $u$  and the edge colored with  $\gamma$  incident with  $v$  will be said to have the type  $\alpha \bullet \beta \circ \gamma$ .

It can be easily checked that the set  $\mathcal{T}$  of trails of type  $\alpha \bullet \beta \circ \gamma$  is a normal odd partition of length 3. We can define in the same way  $\mathcal{T}'$  as the set of trails of type  $\beta \bullet \gamma \circ \alpha$  and  $\mathcal{T}''$  as the set of trails of type  $\gamma \bullet \alpha \circ \beta$ .

Hence  $\mathcal{T}$ ,  $\mathcal{T}'$ , and  $\mathcal{T}''$  are three normal odd partitions of length 3. We claim that these partitions are compatible. Indeed, let  $v \in W$  be a vertex and  $u_1, u_2$  and  $u_3$  be its neighbors. Assume that  $u_1v$  is colored with  $\alpha$ ,  $u_2v$  is colored with  $\beta$  and  $u_3v$  is colored with  $\gamma$ . Hence  $u_1v$  is internal in a trail of  $\mathcal{T}''$  and  $e_{\mathcal{T}''}(v) = vu_3$ . The edge  $u_2v$  is internal in a trail of  $\mathcal{T}$  and  $e_{\mathcal{T}}(v) = vu_1$ . The edge  $u_3v$  is internal in a trail of  $\mathcal{T}'$  and  $e_{\mathcal{T}'}(v) = vu_2$ . Since the same reasoning can be performed in each vertex of  $G$ , the three normal partitions  $\mathcal{T}$ ,  $\mathcal{T}'$  and  $\mathcal{T}''$  are compatible.  $\square$

**Theorem 13** *Let  $G$  be a cubic graph with three compatible normal odd partitions  $\mathcal{T}$ ,  $\mathcal{T}'$ , and  $\mathcal{T}''$ . If  $\mathcal{T}$  has length 3 then  $G$  is a cubic 3-edge-colorable graph*

**Proof** Since  $\mathcal{T}$  has length 3, every trail of  $\mathcal{T}$  has length 3 (see Proposition 10). Hence there is no edge which can be an internal edge of a trail of  $\mathcal{T}'$  and a trail of  $\mathcal{T}''$ , since by Proposition 9 such an edge would be a trail of length 1 in  $\mathcal{T}$ . Thus the perfect matchings associated to  $\mathcal{T}'$  and  $\mathcal{T}''$  (see Theorem 7) would then be disjoint and induce an even 2-factor of  $G$ , which means that  $G$

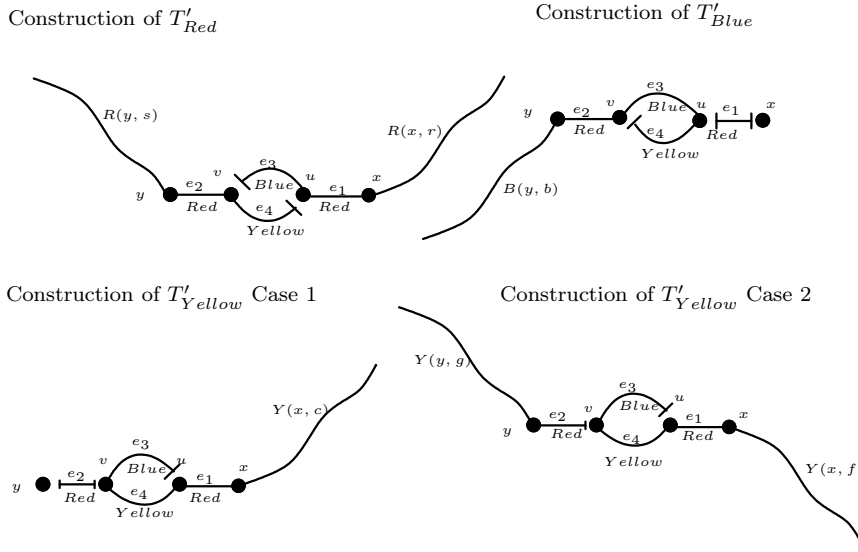

Figure 6: The different cases in Lemma 14.

is a cubic 3-edge-colorable graph as claimed.  $\square$

Lemmas 14, 15, and 16, below, together with Theorem 17, will be useful in proving that a cubic graph with a 3-edge-coloring has three compatible normal odd partitions which are conformal with respect to this coloring (see Corollary 18).

**Lemma 14** *Let  $G$  be a cubic 3-edge-colorable graph. Assume that  $G$  has a proper 3-edge-coloring  $\{Red, Blue, Yellow\}$  together with three compatible normal odd partitions  $\mathcal{T}_{Red}, \mathcal{T}_{Blue}, \mathcal{T}_{Yellow}$  which are, respectively, conformal to Red, Blue and Yellow. Then the graph  $G'$  obtained from  $G$  by subdividing an edge  $e$  such that  $e = xy$  with two vertices  $u$  and  $v$  ( $u$  adjacent to  $x$  and  $v$  adjacent to  $y$ ) and joining these two vertices by an additional edge has also this property.*

**Proof** Assume that  $e = xy$  is colored with Red.

We get a proper 3-edge-coloring of  $G'$  as follows: let the edges  $xu$  and  $vy$  be colored Red while the two other edges incident to  $u$  and  $v$  are colored with the two remaining colors.

Since  $xy$  is colored Red, this edge is internal in  $\mathcal{T}_{Red}$ . Moreover, by Proposition 9, we know that  $xy$  is an end edge in some other partition, say  $\mathcal{T}_{Blue}$ . For  $\mu \in \{Red, Blue, Yellow\}$ , we are going to transform the normal odd partition  $\mathcal{T}_\mu$  of  $G$ , conformal to  $\mu$ , into the normal odd partition  $\mathcal{T}'_\mu$  of  $G'$ , conformal to  $\mu$ .

Let us put  $xu = e_1$  and  $vy = e_2$ , while the edge incident to  $u$  and  $v$  colored with *Blue* is denoted by  $e_3$  and the edge incident to  $u$  and  $v$  colored *Yellow* is denoted by  $e_4$ .

Let  $R \in \mathcal{T}_{Red}$  be the trail containing  $e$ . We write  $R = R(r, x) + xey + R(y, s)$  where  $r$  and  $s$  are end vertices of  $R$ . In order to get the normal odd partition  $\mathcal{T}'_{Red}$  the subtrail  $xey$  of  $R$  is split into two subtrails, namely  $xe_1ue_3v$  and  $ye_2ve_4u$  (see Figure 6). Thus

$$\mathcal{T}'_{Red} = \mathcal{T}_{Red} - \{R\} \cup \{R(r, x) + xe_1ue_3v, R(y, s) + ye_2ve_4u\}.$$

Obviously all the trails of  $\mathcal{T}'_{Red}$  have odd edges of color *Red*.

The edge  $e$  is an end edge of some trail  $B$  of  $\mathcal{T}_{Blue}$ . This trail has  $x$  and some other vertex  $b$  as end vertices. We replace the subtrail  $yex$  of  $B$  with  $ye_2ve_3ue_4v$  and we consider the trail of length 1,  $xe_1u$ . Hence we get a normal odd partition  $\mathcal{T}'_{Blue}$  of  $G'$  conformal with *Blue* as follows:

$$\mathcal{T}'_{Blue} = \mathcal{T}_{Blue} - \{B\} \cup \{xe_1u, ve_4ue_3ve_2y + B(y, b)\}.$$

We have now two cases to consider.

**Case 1:**  $e$  is an end edge of some trail  $Y$  of  $\mathcal{T}_{Yellow}$ .

Hence  $y$  is one end vertex of  $Y$  while  $c$  is the other one. We replace the subtrail  $xey$  of  $Y$  with  $xe_1ue_4ve_3u$  and we add the trail of length 1  $ye_2v$ . In other words:

$$\mathcal{T}'_{Yellow} = \mathcal{T}_{Yellow} - \{Y\} \cup \{ue_3ve_4ue_1x + Y(x, c), ye_2v\}.$$

**Case 2:**  $e$  is an internal edge of some trail  $Y$  of  $\mathcal{T}_{Yellow}$ .

We write  $Y = Y(f, x) + xey + Y(y, g)$ , where  $f$  and  $g$  are end vertices of  $Y$ . We replace the subtrail  $xey$  of  $Y$  with  $xe_1ue_4ve_3u$  and we add the trail  $ye_2v$  of length 1. Thus

$$\mathcal{T}'_{Yellow} = \mathcal{T}_{Yellow} - \{Y\} \cup \{Y(f, x) + xe_1ue_4ve_3u, ye_2v + T_{Yellow}(y, g)\}.$$

In all cases, we get a normal odd partition  $\mathcal{T}'_{Yellow}$  of  $G'$  conformal with *Yellow* and we can check that these three normal odd partitions  $\mathcal{T}'_{Red}$ ,  $\mathcal{T}'_{Blue}$  and  $\mathcal{T}'_{Yellow}$  of  $G'$  are compatible, as expected.  $\square$

**Lemma 15** *Let  $G$  be a 3-edge-colorable cubic graph with the proper 3-edge-coloring  $\{Red, Blue, Yellow\}$ . If  $\mathcal{T}_{Red}$ ,  $\mathcal{T}_{Blue}$ , and  $\mathcal{T}_{Yellow}$  are three compatible normal odd partitions conformal, respectively, to *Red*, *Blue*, and *Yellow*, then the graph  $G'$  obtained from  $G$  by expanding a vertex by a triangle also has this property.*

**Proof** Let  $v$  be a vertex of  $G$  with neighbors  $u_1, u_2, u_3$ . Let us expand the vertex  $v$  by a triangle, say  $abc$ . We color the edges  $ab, ac$ , and  $bc$  in order to get a proper 3-edge-coloring in  $G'$  (see Figure 7). Assume without loss of

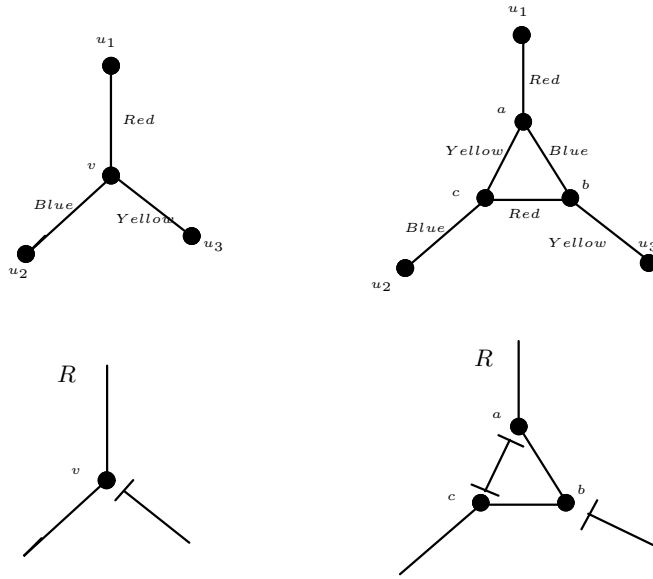

Figure 7: Situation in Lemma 15.

generality that the edge  $ab$  (respectively,  $bc$ ,  $ac$ ) is colored *Blue* (respectively, *Red*, *Yellow*).

We suppose  $e_{\mathcal{T}_{Red}}(v) = vu_3$ . The vertex  $v$  is an internal vertex of some trail in  $\mathcal{T}_{Red}$ , say  $R$ , we replace  $v$  in  $R$  with  $abc$  and we add the trail of length 1,  $ac$ . Thus we get a normal odd partition of the edge set of  $G'$  all of whose trails have odd edges of color *Red*.

We proceed in a similar way for  $\mathcal{T}_{Blue}$  and for  $\mathcal{T}_{Yellow}$  and we get three compatible normal odd partitions with the desired property.  $\square$

Let  $G$  be a simple cubic 3-edge-colorable graph without triangles and with a proper 3-edge-coloring using colors in  $\{Red, Blue, Yellow\}$ . Let  $\mathcal{T}_{Red}$ ,  $\mathcal{T}_{Blue}$ , and  $\mathcal{T}_{Yellow}$  be three normal odd partitions conformal, respectively, to *Red*, *Blue*, and *Yellow*. With these hypotheses, given a vertex  $v$  of  $G$ , denote by  $v_1$ ,  $v_2$ , and  $w$  the neighbors of  $v$  such that  $vv_1 \in Red$ ,  $vv_2 \in Blue$ , and  $vw \in Yellow$ . In addition, let  $w_1$  and  $w_2$  be the neighbors of  $w$  satisfying  $ww_1 \in Red$  and  $ww_2 \in Blue$ . Let  $R_v$  (respectively,  $B_v$ ,  $Y_v$ ) be the trail of  $\mathcal{T}_{Red}$  (respectively, of  $\mathcal{T}_{Blue}$ ,  $\mathcal{T}_{Yellow}$ ) that contains  $v$  as an internal vertex and  $R'_v$  (respectively,  $B'_v$ ,  $Y'_v$ ) be the trail of  $\mathcal{T}_{Red}$  (respectively,  $\mathcal{T}_{Blue}$ ,  $\mathcal{T}_{Yellow}$ ) for which  $v$  is an end vertex.

Let  $r_v$  and  $s_v$  be the end vertices of  $R_v$ : more precisely,  $r_v$  is the end vertex of the subtrail  $R(v, r_v)$  having the end edge adjacent to  $v$  colored with *Red*. The vertices  $b_v$  and  $c_v$  are defined in an analogous way for the trail  $B_v$  as well as the vertices  $y_v$  and  $z_v$  for  $Y_v$ .

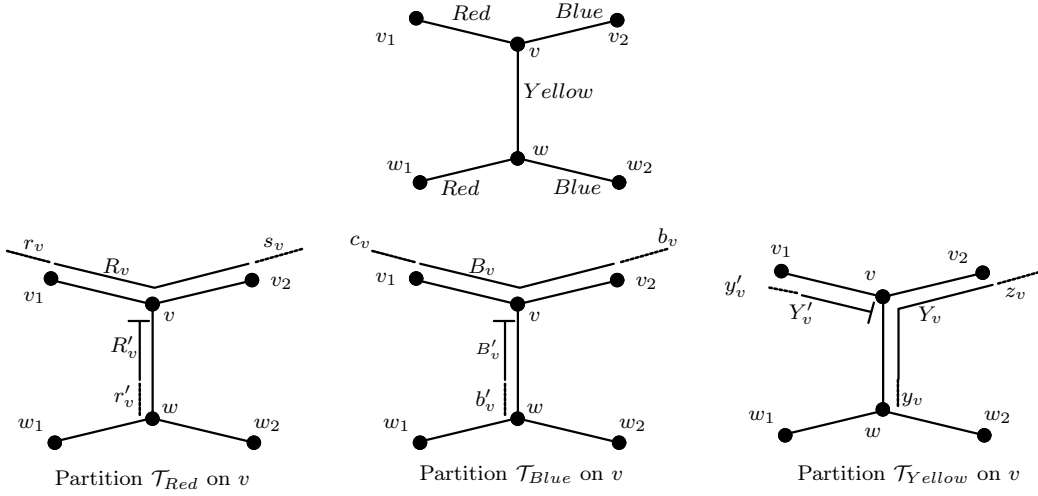

Figure 8: Initial situation in Lemma 16.

Moreover,  $r'_v$  denotes the end vertex of the trail  $R'_v$  distinct from  $v$ , and the vertices  $b'_v$  and  $y'_v$  are defined similarly for the trails  $B'_v$  and  $Y'_v$ .

**Lemma 16** *Let  $G$  be a simple cubic 3-edge-colorable graph without triangles and with the proper 3-edge-coloring  $\{\text{Red}, \text{Blue}, \text{Yellow}\}$ . Let  $\mathcal{T}_{\text{Red}}$ ,  $\mathcal{T}_{\text{Blue}}$ , and  $\mathcal{T}_{\text{Yellow}}$  be three normal odd partitions conformal to Red, Blue, and Yellow such that  $A(\mathcal{T}_{\text{Red}}, \mathcal{T}_{\text{Blue}}, \mathcal{T}_{\text{Yellow}})$  has minimum size.*

*Let  $v$  be a vertex of  $G$ . If  $v \in A_{\mathcal{T}_{\text{Red}}\mathcal{T}_{\text{Blue}}}$ , and, using the notations above, if  $vv_1$  is an end edge of  $Y'_v$  (see Figure 8), then, as shown in Figure 9:*

1.  $r_v = v$  and  $R_v = R'_v$ ,
2.  $w \notin A(\mathcal{T}_{\text{Red}}, \mathcal{T}_{\text{Blue}}, \mathcal{T}_{\text{Yellow}})$ ,
3.  $B'_v = B'_w = vw$ ,
4.  $Y_v = Y_w = Y'_v = Y'_w$  and the edges  $vv_1$ ,  $w_2w$ ,  $wv$ ,  $vv_2$  and  $w_1w$  occur in that order on the trail.

**Proof** We prove successively items one to four.

**Proof of item 1.**

Assume that  $r_v \neq v$ . We use a conformal switching of  $\mathcal{T}_{\text{Red}}$  on  $v$  and we get a normal odd partition  $\mathcal{T}'_{\text{Red}}$  as follows:

$$\mathcal{T}'_{\text{Red}} = \mathcal{T}_{\text{Red}} - \{R_v, R'_v\} \cup \{R'_v + R_v(v, r_v), R_v(v, s_v)\}.$$

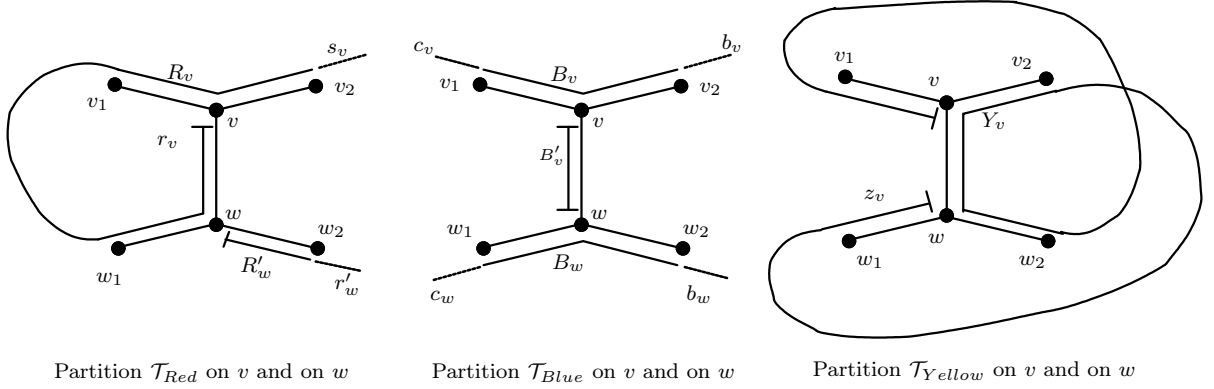

Figure 9: Final situation in Lemma 16.

Observe that the trails  $R'_v + R_v(v, r_v)$  and  $R_v(v, s_v)$  are odd and that  $vv_1$  remains to be an odd edge of  $R'_v + R_v(v, r_v)$ . Since we have  $e_{\mathcal{T}'_{Red}}(v) = vv_2$ ,  $|A(\mathcal{T}'_{Red}, \mathcal{T}_{Blue}, \mathcal{T}_{Yellow})| = |A(\mathcal{T}_{Red}, \mathcal{T}_{Blue}, \mathcal{T}_{Yellow})| - 1$ , a contradiction. Thus  $r_v = v$  and  $R_v = R'_v$ .

**Proof of item 2.**

Assume that  $w \in A(\mathcal{T}_{Red}, \mathcal{T}_{Blue}, \mathcal{T}_{Yellow})$ . We know by item 1 that  $e_{\mathcal{T}_{Red}}(w) = ww_2$ . We get a normal odd partition  $\mathcal{T}'_{Red}$  from  $\mathcal{T}_{Red}$  by using conformal switches of  $\mathcal{T}_{Red}$  on  $w$  and  $v$ . More precisely, we write

$$\mathcal{T}'_{Red} = \mathcal{T}_{Red} - \{R_v, R'_w\} \cup \{wv + R_v(v, w) + R'_w, R_v(v, s_v)\}.$$

Once again, when performing those operations we get three odd normal partitions which are compatible on  $v$ , a contradiction since  $|A(\mathcal{T}'_{Red}, \mathcal{T}_{Blue}, \mathcal{T}_{Yellow})| = |A(\mathcal{T}_{Red}, \mathcal{T}_{Blue}, \mathcal{T}_{Yellow})| - 1$ .

**Proof of item 3.**

Since  $R_v$  contains the edge  $w_1w$ , the vertex  $w$  and ends with  $v$ , we must have  $e_{\mathcal{T}_{Red}}(w) = ww_2$ . Moreover, since  $w \notin A(\mathcal{T}_{Red}, \mathcal{T}_{Blue}, \mathcal{T}_{Yellow})$ , we have  $e_{\mathcal{T}_{Yellow}}(w) \neq ww_2$  and the edge  $wv$  must be an internal edge of  $Y_w$ . Hence  $e_{\mathcal{T}_{Yellow}}(w) = ww_1$  and  $Y_w = Y_v$ , it follows that  $wv$  is an end edge of  $B'_v$ , i.e., that the trail  $B'_v$  has length 1 and  $B'_v = B'_w = vw$ .

**Proof of item 4.**

Now consider the trails of  $\mathcal{T}_{Yellow}$ . We already know that  $Y_v = Y_w$ , thus  $z_v = y_w$  and  $y_v = z_w$ , and furthermore  $vv_1$  is an end edge of  $Y'_v$  while  $ww_1$  is an end edge of  $Y'_w$ .

Assume first that  $z_v \neq w$ . We proceed successively to two conformal switchings (of  $\mathcal{T}_{Blue}$  and  $\mathcal{T}_{Yellow}$ ) on  $w$ :

1. a switching of  $\mathcal{T}_{Blue}$  on  $w$  which leads to

$$\mathcal{T}'_{Blue} = \mathcal{T}_{Blue} - \{B_w, B'_v\} \cup \{B_w(w, c_w), vw + B_w(w, b_w)\},$$



2. a switching  $\mathcal{T}_{Yellow}$  on  $w$ :

$$\mathcal{T}'_{Yellow} = \mathcal{T}_{Yellow} - \{Y_v, Y'_w\} \cup \{Y'_w + wv + Y_v(v, z_v), Y_v(w, y_v)\}.$$

When  $R_v$  and  $R'_w$  are distinct trails, we proceed to a switching of  $\mathcal{T}_{Red}$  on  $w$  and  $v$ :

$$\mathcal{T}'_{Red} = \mathcal{T}_{Red} - \{R_v, R'_w\} \cup \{wv + R_v(v, w) + R'_w, R'_w(v, s_v)\}.$$

If, on the contrary,  $R_v = R'_v = R'_w = R_w$ , we set  $\mathcal{T}'_{Red}$  in order to have  $e_{\mathcal{T}'_{Red}}(v) = vv_2$  and  $e_{\mathcal{T}'_{Red}}(w) = wv$ , that is, we proceed successively to the four following conformal switchings:

- a conformal switching of  $\mathcal{T}_{Red}$  on  $v_1$ ,
- a conformal switching of  $\mathcal{T}_{Red}$  on  $w$ ,
- a conformal switching of  $\mathcal{T}_{Red}$  on  $v$ ,
- a conformal switching of  $\mathcal{T}_{Red}$  on  $v_1$ .

Hence we get

$$\mathcal{T}'_{Red} = \mathcal{T}_{Red} - \{R_v\} \cup \{wvv_1 + R_v(v_1, w_1) + w_1ww_2 + R'_w(w_2, v_2) + v_2v\}.$$

Moreover, a conformal switching of  $\mathcal{T}_{Blue}$  on  $w$  and a conformal switching of  $\mathcal{T}_{Yellow}$  on  $w$  lead us to

$$\mathcal{T}'_{Blue} = \mathcal{T}_{Blue} - \{B_w, B'_v\} \cup \{B_w(w, c_w), vw + B_w(w, b_w)\},$$

$$\mathcal{T}'_{Yellow} = \mathcal{T}_{Yellow} - \{Y_v, Y'_w\} \cup \{Y'_w + wv + Y_v(v, z_v), Y_v(w, y_v)\}.$$

But now, in both cases,  $A(\mathcal{T}'_{Red}, \mathcal{T}'_{Blue}, \mathcal{T}'_{Yellow})$  has fewer vertices than  $A(\mathcal{T}_{Red}, \mathcal{T}_{Blue}, \mathcal{T}_{Yellow})$ , a contradiction.

>From now on we can suppose  $z_v = w$  and therefore  $Y_v = Y_w = Y'_w$ . When  $z_w \neq v$ , we perform the conformal switching of  $\mathcal{T}_{Blue}$  and  $\mathcal{T}_{Yellow}$  on  $v$  and we get two new normal odd partitions, which are

$$\mathcal{T}'_{Yellow} = \mathcal{T}_{Yellow} - \{Y_v, Y'_v\} \cup \{Y_v(v, z_v), Y'_v + vw + Y_w(w, z_w)\},$$

$$\mathcal{T}'_{Blue} = \mathcal{T}_{Blue} - \{B_v, B'_v\} \cup \{wv + B_v(v, b_v), B_v(v, c_v)\}.$$

It follows that  $|A(\mathcal{T}_{Red}, \mathcal{T}'_{Blue}, \mathcal{T}'_{Yellow})| = |A(\mathcal{T}_{Red}, \mathcal{T}_{Blue}, \mathcal{T}_{Yellow})| - 1$ , a contradiction. Consequently,  $z_w = v$  and  $Y_v = Y_w = Y'_v = Y'_w$ , which proves the lemma.  $\square$

**Theorem 17** *Let  $G$  be a simple cubic 3-edge-colorable graph without triangles. If  $G$  has a proper 3-edge-coloring  $\{Red, Blue, Yellow\}$ , then  $G$  has three compatible normal odd partitions  $\mathcal{T}_{Red}$ ,  $\mathcal{T}_{Blue}$  and  $\mathcal{T}_{Yellow}$  which are conformal, respectively, to Red, Blue, and Yellow.*

**Proof** Let us consider three odd normal partitions  $\mathcal{T}_{Red}$ ,  $\mathcal{T}_{Blue}$ , and  $\mathcal{T}_{Yellow}$  such that the odd edges are colored *Red*, *Blue*, and *Yellow*, respectively. Assume that  $\mathcal{T}_{Red}$ ,  $\mathcal{T}_{Blue}$ , and  $\mathcal{T}_{Yellow}$  are such that the size of  $A(\mathcal{T}_{Red}, \mathcal{T}_{Blue}, \mathcal{T}_{Yellow})$  is minimum. We suppose  $A(\mathcal{T}_{Red}, \mathcal{T}_{Blue}, \mathcal{T}_{Yellow}) \neq \emptyset$ : otherwise,  $\mathcal{T}_{Red}$ ,  $\mathcal{T}_{Blue}$  and  $\mathcal{T}_{Yellow}$  are compatible and the proof is complete.

Let  $v \in A(\mathcal{T}_{Red}, \mathcal{T}_{Blue}, \mathcal{T}_{Yellow})$ . Without loss of generality, we suppose  $v \in A_{\mathcal{T}_{Red}\mathcal{T}_{Blue}}$ . Using the notations given above,  $v_1$ ,  $v_2$  and  $w$  are the neighbors of  $v$  such that  $vv_1 \in Red$ ,  $vv_2 \in Blue$ , and  $vw \in Yellow$ , while  $w_1$  and  $w_2$  are neighbors of  $w$  such that  $ww_1 \in Red$  and  $ww_2 \in Blue$ . Hence  $e_{\mathcal{T}_{Red}}(v) = vv = e_{\mathcal{T}_{Blue}}(v)$ . Moreover, since  $e_{\mathcal{T}_{Yellow}}(v) \neq vw$ , we can assume that  $e_{\mathcal{T}_{Yellow}}(v) = vv_1$ .

We know, by Lemma 16, that  $r_v = v$ ,  $B'_v = B'_w = vw$ ,  $e_{\mathcal{T}_{Yellow}}(w) = w_1w$ ,  $Y_v = Y_w$ ,  $z_v = y_w = w$ , and  $y_v = z_w = v$ . Furthermore,  $w \notin A(\mathcal{T}_{Red}, \mathcal{T}_{Blue}, \mathcal{T}_{Yellow})$ .

**Claim**  $w_2 \notin A(\mathcal{T}_{Red}, \mathcal{T}_{Blue}, \mathcal{T}_{Yellow})$  and  $r'_w = w_2$ .

**Proof** Assume  $w_2 \in A(\mathcal{T}_{Red}, \mathcal{T}_{Blue}, \mathcal{T}_{Yellow})$ . By using the conformal switching of  $\mathcal{T}_{Blue}$  on  $v$ , the conformal switching of  $\mathcal{T}_{Yellow}$  on  $w_2$ , and a final conformal switching on  $v$ , we obtain

1. the conformal switching of  $\mathcal{T}_{Blue}$  on  $v$  leads to

$$\mathcal{T}'_{Blue} = \mathcal{T}_{Blue} - \{B_v, B'_v\} \cup \{vw + B(v, b_v), B(v, c_v)\},$$

2. after a conformal switching of  $\mathcal{T}_{Yellow}$  on  $w_2$ , we have:

$$\mathcal{T}'_{Yellow} = \mathcal{T}_{Yellow} - \{Y_v, Y'_{w_2}\} \cup \{Y'_v(v, w_2) + Y'_{w_2}, w_2w + vw + Y_v(v, w)\},$$

3. we now perform a conformal switching of  $\mathcal{T}'_{Yellow}$  on  $v$ , hence

$$\mathcal{T}''_{Yellow} = \mathcal{T}'_{Yellow} - \{Y_v(v, y'_{w_2}), Y_v(w, w_2)\} \cup \{Y_v(v, w), w_2w + vw + Y_v(v, y'_{w_2})\}.$$

But we have  $A(\mathcal{T}_{Red}, \mathcal{T}'_{Blue}, \mathcal{T}''_{Yellow}) = A(\mathcal{T}_{Red}, \mathcal{T}_{Blue}, \mathcal{T}_{Yellow}) - \{v\}$ , a contradiction to the choice of  $\mathcal{T}_{Red}$ ,  $\mathcal{T}_{Blue}$  and  $\mathcal{T}_{Yellow}$ .

We can suppose now  $w_2 \notin A(\mathcal{T}_{Red}, \mathcal{T}_{Blue}, \mathcal{T}_{Yellow})$ , the edge  $ww_2$  being an internal edge of  $B_w \in \mathcal{T}_{Blue}$  and an internal edge of  $Y_v \in \mathcal{T}_{Yellow}$ , and since  $w, w_2 \notin A(\mathcal{T}_{Red}, \mathcal{T}_{Blue}, \mathcal{T}_{Yellow})$ , by Proposition 9, the trail  $R'_w$  has length 1. Hence we can write  $R'_w = ww_2$ , that is,  $r'_w = w_2$ .  $\blacksquare$

Let us first use a conformal switching of  $\mathcal{T}_{Red}$  on  $w$  (recall that  $r'_w = w_2$ ) followed by a conformal switching of the resulting *Red* partition on  $w$  as well as a final conformal switching of  $\mathcal{T}_{Blue}$  on  $w$ , in other words, we get the odd normal partitions:

$$\mathcal{T}'_{Red} = \mathcal{T}_{Red} - \{R_v, R'_w\} \cup \{R_v(v, s_v), vw + R_v(v, w) + ww_2\}$$

and

$$\mathcal{T}'_{Blue} = \mathcal{T}_{Blue} - \{B'_v, B_w\} \cup \{vw + B_w(w, b_w), B_w(w, c_w)\}.$$

We have  $v \notin A(\mathcal{T}'_{Red}, \mathcal{T}'_{Blue}, \mathcal{T}_{Yellow})$  and  $w \in A(\mathcal{T}'_{Red}, \mathcal{T}'_{Blue}, \mathcal{T}_{Yellow})$ . More precisely,  $w \in A_{\mathcal{T}'_{Blue}\mathcal{T}_{Yellow}}$ . It follows that  $A(\mathcal{T}'_{Red}, \mathcal{T}'_{Blue}, \mathcal{T}_{Yellow})$  and  $A(\mathcal{T}_{Red}, \mathcal{T}_{Blue}, \mathcal{T}_{Yellow})$  have the same size.

Observe that the trail  $wv + R_v(v, w) + ww_2$  of  $\mathcal{T}'_{Red}$  contains  $w$  and  $w_2$  as end vertices. Since  $w \in A_{\mathcal{T}'_{Blue}\mathcal{T}_{Yellow}}$  and  $A(\mathcal{T}'_{Red}, \mathcal{T}'_{Blue}, \mathcal{T}_{Yellow})$  has minimum size, we apply Lemma 16 to the vertices  $w$  and  $w_1$ . It follows that the trail of  $\mathcal{T}'_{Red}$  having  $wv$  as an end edge must have  $w$  and  $w_1$  as end vertices, a contradiction since this trail ends with  $w$  and  $w_2$ .  $\square$

Due to Lemmas 14 and 15, Theorem 17 can be easily extended to 3-edge-colorable cubic graphs having multiple edges or triangles.

**Corollary 18** *If  $G$  is a cubic 3-edge-colorable graph with a proper 3-edge-coloring  $\{Red, Blue, Yellow\}$ , then  $G$  has three compatible normal odd partitions  $\mathcal{T}_{Red}$ ,  $\mathcal{T}_{Blue}$  and  $\mathcal{T}_{Yellow}$  which are conformal, respectively, to Red, Blue, Yellow.*

## 4 On cubic graphs with chromatic index four

A snark is a bridgeless cubic graph with edge chromatic number four. By Proposition 11, a cubic graph with three compatible normal odd partitions must be bridgeless. Thus in this section we consider the problem of providing three compatible normal odd partitions for some known snarks as the families of Flower snarks as well as Goldberg snarks.

In Figures 10(a), 10(b) and 10(c) we give three compatible normal odd partitions of the Petersen graph. It can be pointed out that these three compatible normal odd partitions are isomorphic. Indeed, we have in each partition, a path of length five, three paths of lengths three, and one path of length unity. In some sense this fact shows that Theorem 13 is sharp.

### 4.1 Flower snarks

For an odd  $k$  such that  $k \geq 3$ , let  $F_k$  be the cubic graph on  $4k$  vertices  $u_1, u_2, \dots, u_k, v_1, v_2, \dots, v_k, w_1, w_2, \dots, w_k, t_1, t_2, \dots, t_k$  such that  $u_1u_2 \dots u_k$  is an induced cycle of length  $k$ ,  $w_1w_2 \dots w_k t_1 t_2 \dots t_k$  is an induced cycle of length  $2k$  and for  $1 \leq i \leq k$  the vertex  $v_i$  is adjacent to  $u_i, w_i$  and  $t_i$ . For odd  $k$  such that  $k \geq 5$ , the graph  $F_k$  is known as a Flower snark (see [6]) while  $F_3$  is sometimes known as Tietze's graph (see [1]).

**Proposition 19** *If  $k \geq 3$  is an odd integer,  $F_k$  can be provided with three compatible normal odd partitions.*

**Proof** In Figure 11 we propose three compatible normal odd partitions, namely  $\mathcal{T}_1$ ,  $\mathcal{T}_2$  and  $\mathcal{T}_3$ , of Tietze's graph  $F_3$ . Moreover, when considering the vertices  $u_1, v_1, w_1, t_1, u_2, v_2, w_2, t_2$ , we have the following situation (recall that  $k = 3$ ):

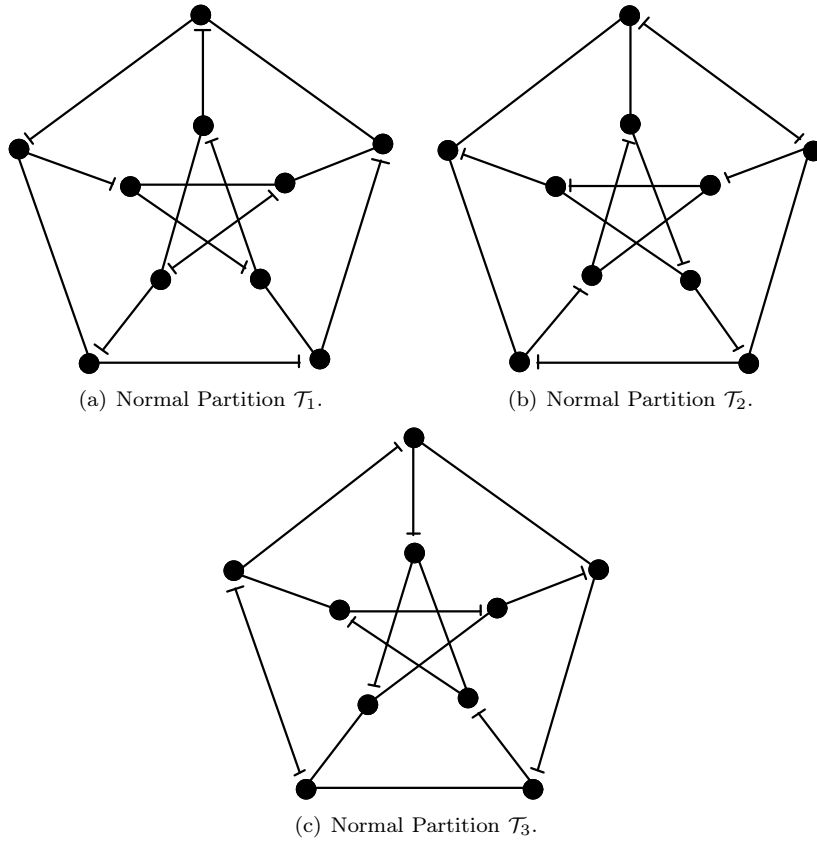

Figure 10: Three compatible normal odd partitions  $\mathcal{T}_1$ ,  $\mathcal{T}_2$ , and  $\mathcal{T}_3$ , of the Petersen graph.

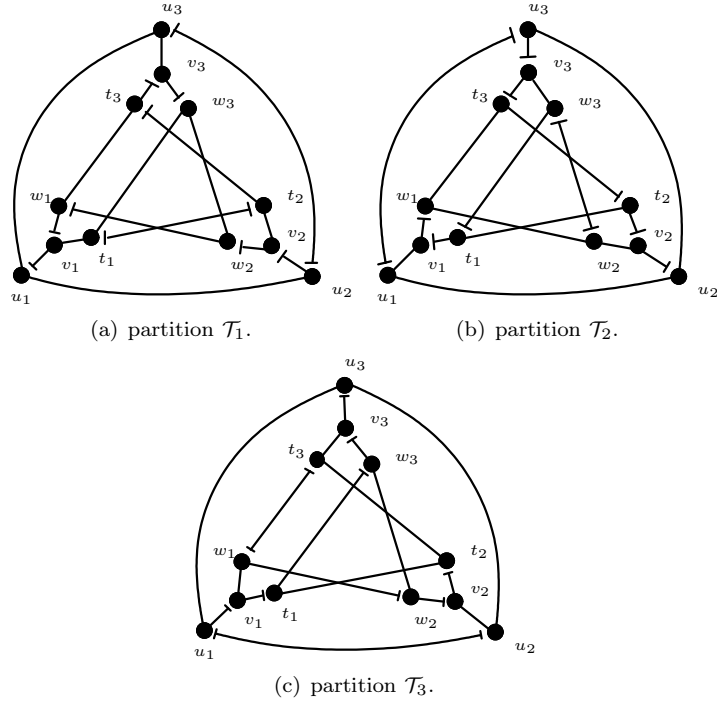

Figure 11: Three compatible normal odd partitions of the Flower snark  $F_3$ .

$$e_{\mathcal{T}_1}(u_1) = u_1v_1, e_{\mathcal{T}_1}(v_1) = v_1w_1, e_{\mathcal{T}_1}(w_1) = w_1w_2, e_{\mathcal{T}_1}(t_1) = t_1t_2 \quad (1)$$

$$e_{\mathcal{T}_2}(u_1) = u_1u_3, e_{\mathcal{T}_2}(v_1) = v_1t_1, e_{\mathcal{T}_2}(w_1) = w_1v_1, e_{\mathcal{T}_2}(t_1) = t_1w_k \quad (2)$$

$$e_{\mathcal{T}_3}(u_1) = u_1u_2, e_{\mathcal{T}_3}(v_1) = v_1u_1, e_{\mathcal{T}_3}(w_1) = w_1t_k, e_{\mathcal{T}_3}(t_1) = t_1v_1 \quad (3)$$

$$e_{\mathcal{T}_1}(u_2) = u_2u_3, e_{\mathcal{T}_1}(v_2) = v_2u_2, e_{\mathcal{T}_1}(w_2) = w_2v_2, e_{\mathcal{T}_1}(t_2) = t_2t_1 \quad (4)$$

$$e_{\mathcal{T}_2}(u_2) = u_2v_2, e_{\mathcal{T}_2}(v_2) = v_2t_2, e_{\mathcal{T}_2}(w_2) = w_2w_3, e_{\mathcal{T}_2}(t_2) = t_2t_3 \quad (5)$$

$$e_{\mathcal{T}_3}(u_2) = u_2u_1, e_{\mathcal{T}_3}(v_2) = v_2w_2, e_{\mathcal{T}_3}(w_2) = w_2w_1, e_{\mathcal{T}_3}(t_2) = t_2v_2. \quad (6)$$

Observe that among the edges  $u_1u_2, w_1w_2$  and  $t_1t_2$  we have

$u_1u_2$  is an odd edge in  $\mathcal{T}_1$ ,  $t_1t_2$  is an odd edge in  $\mathcal{T}_2$  and in  $\mathcal{T}_3$ .

Assume that for an odd integer  $k$ ,  $k \geq 3$ ,  $F_k$  is provided with three compatible normal odd partitions, namely  $\mathcal{T}_1$ ,  $\mathcal{T}_2$  and  $\mathcal{T}_3$ . Suppose further that the Properties above (1)–(6) are verified by  $\mathcal{T}_1$ ,  $\mathcal{T}_2$ , and  $\mathcal{T}_3$ .

We derive  $F_{k+2}$  from  $F_k$  as follows:

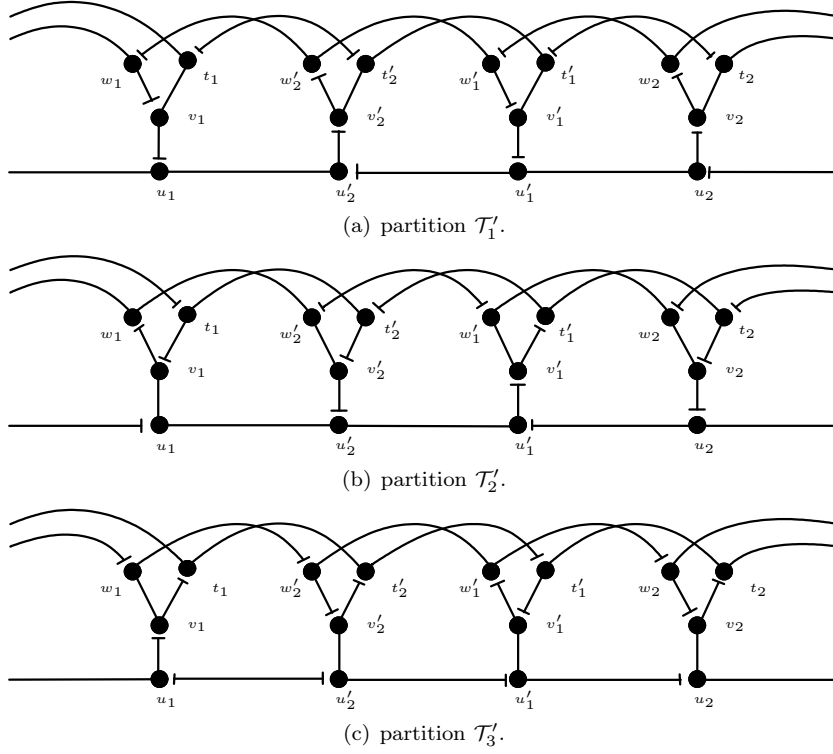

Figure 12: Extension of three compatible normal odd partitions from the Flower snark  $F_k$  to the Flower snark  $F_{k+2}$ .

$$\begin{aligned}
V(F_{k+2}) &= V(F_k) \cup \{u'_1, v'_1, w'_1, t'_1, u'_2, v'_2, w'_2, t'_2\} \\
E(F_{k+2}) &= E(F_k) - \{u_1u_2, w_1w_2, t_1t_2\} \\
&\quad \cup \{u_1u'_2, w_1w'_2, t_1t'_2\} \\
&\quad \cup \{v'_2u'_2, v'_2w'_2, v'_2t'_2\} \\
&\quad \cup \{u'_2u'_1, w'_2w'_1, t'_2t'_1\} \\
&\quad \cup \{v'_1u'_1, v'_1w'_1, v'_1t'_1\} \\
&\quad \cup \{u'_1u_2, w'_1w_2, t'_1t_2\}
\end{aligned}$$

In other words, we insert eight new vertices into  $F_k$ , we delete the edges  $u_1u_2$ ,  $w_1w_2$ ,  $t_1t_2$  and add new edges in order to obtain the Flower snark  $F_{k+2}$ .

Figures 12(a), 12(b), and 12(c) show three normal partitions of  $F_{k+2}$ ,  $\mathcal{T}'_1$ ,  $\mathcal{T}'_2$  and  $\mathcal{T}'_3$  obtained, respectively, from  $\mathcal{T}_1$ ,  $\mathcal{T}_2$  and  $\mathcal{T}_3$ .

But now we rename some vertices of  $F_{k+2}$  as follows: For  $i \geq 2$ , the vertices  $u_i$ ,  $v_i$ ,  $w_i$ , and  $t_i$ , are renamed, respectively,  $u_{i+2}$ ,  $v_{i+2}$ ,  $w_{i+2}$ , and  $t_{i+2}$ . The vertices  $u'_1$ ,  $v'_1$ ,  $w'_1$ , and  $t'_1$  are renamed, respectively,  $u_3$ ,  $v_3$ ,  $w_3$ , and  $t_3$ . The vertices  $u'_2$ ,  $v'_2$ ,  $w'_2$ , and  $t'_2$  are renamed, respectively,  $u_2$ ,  $v_2$ ,  $w_2$ , and  $t_2$ .

It is a routine matter to check that those partitions are odd, compatible, and satisfy Properties (1)–(6).  $\square$

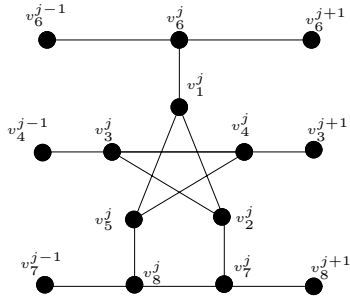

Figure 13: Adjacencies in a Goldberg Snark.

## 4.2 Goldberg snarks

For every odd  $k$  such that  $k \geq 3$ , the Goldberg snark  $G_k$  is defined as follows:  $V(G_k) = \{v_i^j : 1 \leq i \leq 8, 0 \leq j \leq k-1\}$  and adjacencies are defined as shown in Figure 13. The superscript  $j$  is always considered modulo  $k$ . Moreover,  $v_6^k = v_6^0$ ,  $v_3^k = v_3^0$ , and  $v_8^k = v_8^0$ .

**Proposition 20** *If  $k \geq 3$  is an odd integer,  $G_k$  can be provided with three compatible normal odd partitions.*

**Proof** The proofs of Propositions 19 and 20 are similar. Thus we do not give the details. We just mention that Figure 14 gives three compatible normal odd partitions of  $G_3$  while Figure 15 describes the construction of such partitions for  $G_{k+2}$  from those of  $G_k$ .  $\square$

## 5 Open Problems

Fan and Raspaud [2] conjectured that every bridgeless cubic graph can be provided with three perfect matchings with empty intersection. The following Conjecture 21 is due to Fulkerson: it appears first in [4] and is known as the Berge–Fulkerson Conjecture.

**Conjecture 21** *If  $G$  is a bridgeless cubic graph, then there exist six perfect matchings  $M_1, \dots, M_6$  of  $G$  with the property that every edge of  $G$  is contained in exactly two of  $M_1, \dots, M_6$ .*

**Theorem 22** *If  $G$  is a cubic graph with three compatible normal odd partitions, then there exist three perfect matchings  $M$ ,  $M'$ , and  $M''$  such that  $M \cap M' \cap M'' = \emptyset$ .*

**Proof** Let  $M$ ,  $M'$ , and  $M''$  be the associated perfect matchings of  $\mathcal{T}$ ,  $\mathcal{T}'$ , and  $\mathcal{T}''$ , respectively. Let  $v$  be a vertex and  $u_1, u_2$  and  $u_3$  its neighbors.  $\mathcal{T}$ ,  $\mathcal{T}'$  and  $\mathcal{T}''$  being compatible, we can suppose  $e_{\mathcal{T}}(v) = vu_1$ ,  $e_{\mathcal{T}'}(v) = vu_2$ , and

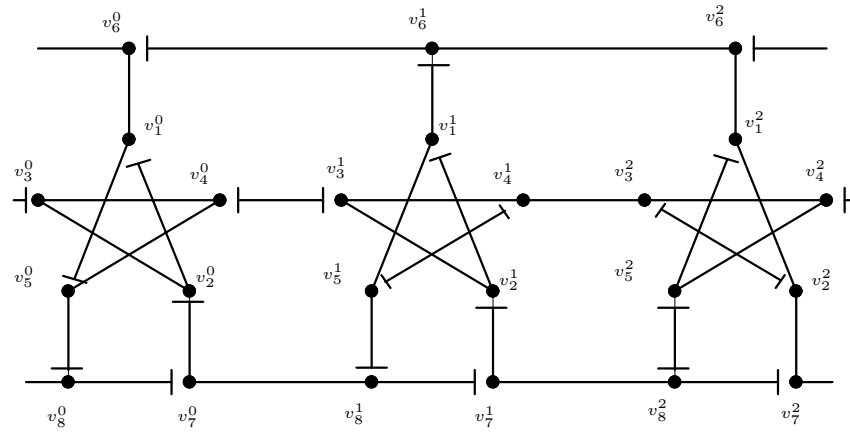

(a) partition  $\mathcal{T}_1$ .

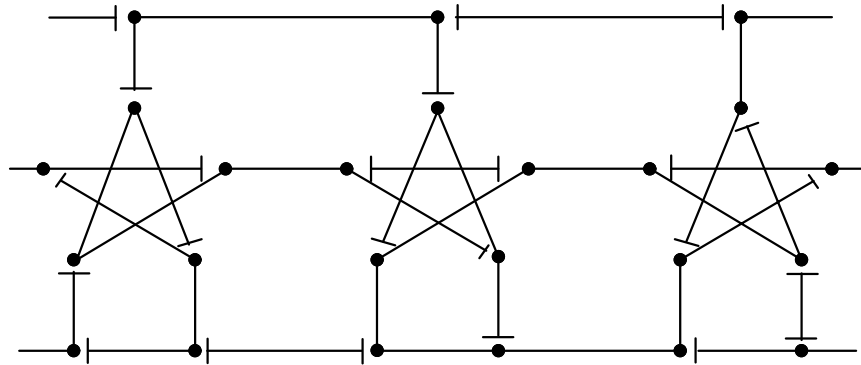

(b) partition  $\mathcal{T}_2$ .

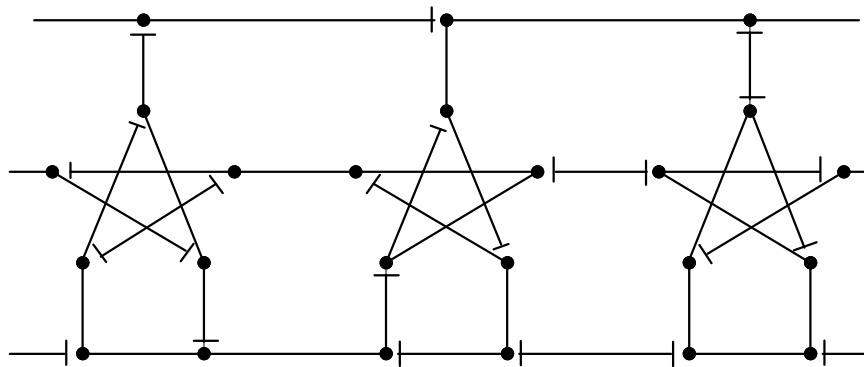

(c) partition  $\mathcal{T}_3$ .

Figure 14: Three compatible normal odd partitions of the Goldberg snark  $G_3$ .



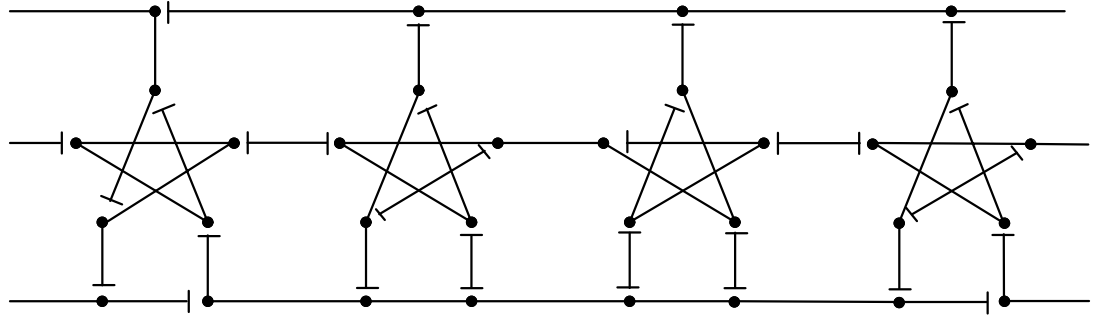

(a) partition  $\mathcal{T}'_1$ .

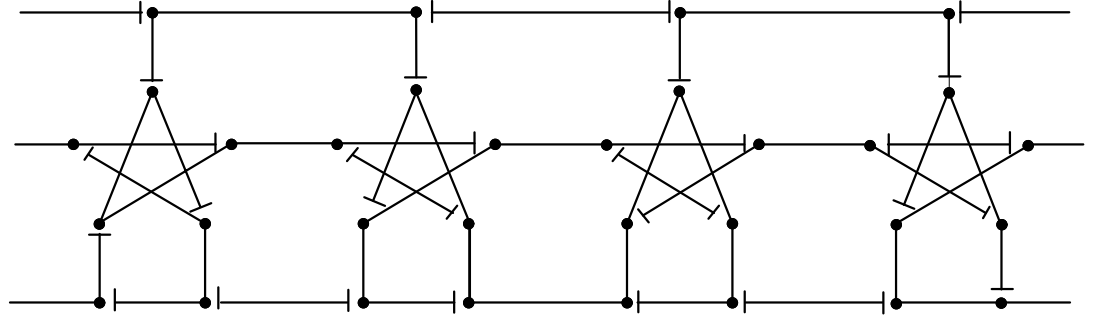

(b) partition  $\mathcal{T}'_2$ .

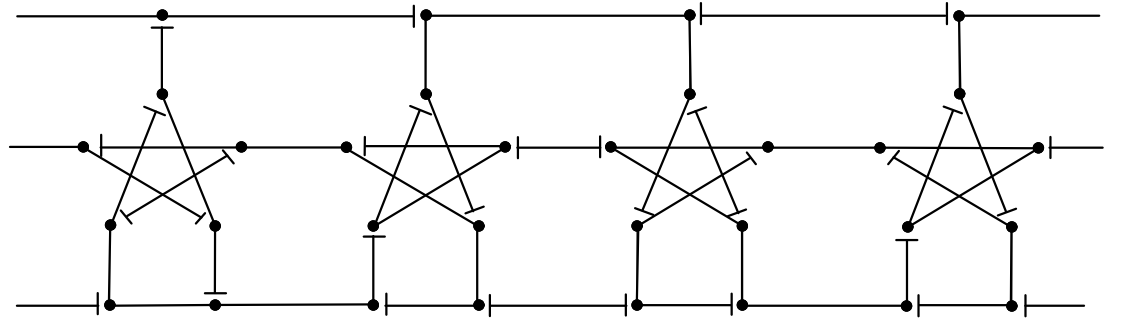

(c) partition  $\mathcal{T}'_3$ .

Figure 15: Extending three compatible normal odd partitions from the Goldberg snark  $G_k$  to the Goldberg snark  $G_{k+2}$ .

$e_{\mathcal{T}''}(v) = vu_3$ . The edge  $vu_1$  is an end edge of a trail in  $\mathcal{T}$ . This edge is not an odd edge in  $\mathcal{T}$  and thus  $vu_1 \notin M$ . In the same way,  $vu_2 \notin M'$  and  $vu_3 \notin M''$ . Hence every edge incident to  $v$  is contained in at most two perfect matchings among  $M, M'$ , and  $M''$ . This means that  $M \cap M' \cap M'' = \emptyset$ .  $\square$

Theorem 22 above implies that the Fan and Raspaud Conjecture is true for graphs with three compatible normal odd partitions and we propose the following new conjecture.

**Conjecture 23** *Any bridgeless cubic graph can be provided with three compatible normal odd partitions.*

We do not know whether this new conjecture is equivalent to the Fan and Raspaud conjecture or not, or whether it is implied by the Berge–Fulkerson Conjecture.

Let  $\mathcal{S} = \{\mathcal{T}_1, \mathcal{T}_2, \dots, \mathcal{T}_k\}$  ( $k \geq 3$ ) be a set of odd normal partitions of a cubic graph  $G$ . The set  $\mathcal{S}$  will be said to be a *complete system of odd normal partitions of order  $k$*  whenever for any vertex  $v$  of  $G$  there are three partitions in  $\mathcal{S}$  which are compatible on  $v$ , that is, there are  $\mathcal{T}, \mathcal{T}'$ , and  $\mathcal{T}''$  (depending on  $v$ ) in  $\mathcal{S}$  such that  $e_{\mathcal{T}}(v)$ ,  $e_{\mathcal{T}'}(v)$ , and  $e_{\mathcal{T}''}(v)$  are three distinct edges.

**Problem 24** *Is it true that there exists  $k \geq 3$  such that every bridgeless cubic graph has a complete system of odd normal partitions of order at most  $k$ ?*

If a cubic graph has a complete system of normal odd partitions of order  $k$ , then it has  $k$  perfect matchings with empty intersection. This conjecture would imply that the conclusions of Conjecture 25 below would hold for bridgeless cubic graphs.

**Conjecture 25** [5] *There exists  $k \geq 2$  such that every  $r$ -graph contains  $k + 1$  perfect matchings with empty intersection.*

As a matter of fact, in this Conjecture, the integer  $k$  depends on  $r$ .

**Acknowledgements:** The authors wish to thank the anonymous reviewers: their remarks and suggestions greatly contributed to many improvements. Let us thank also Robert Thorn for his helpful proofreading and correcting.

## References

- [1] J.A. Bondy and U.S.R. Murty. *Graph Theory*, volume 244 of *Graduate Texts in Mathematics*. Springer, 2008.
- [2] G. Fan and A. Raspaud. Fulkerson’s conjecture and circuit covers. *J. Comb. Theory Ser. B*, 61:133–138, 1994.
- [3] J.L. Fouquet and J.M. Vanherpe. On normal odd partitions in cubic graphs. *Discussiones Mathematicae Graph Theory*, 29(2):293–312, 2009.

- [4] D.R. Fulkerson. Blocking and anti-blocking pairs of polyhedra. *Math. Programming*, 1(69):168–194, 1971.
- [5] L. Goddyn. Cones, lattices and Hilbert bases of circuits and perfect matchings. In N. Robertson and P. Seymour, editors, *Graph Structure Theory*, Contemporary Mathematics Volume 147, pages 419–439. American Mathematical Society, 1993.
- [6] R. Isaacs. Infinite families of non-trivial trivalent graphs which are not Tait colorable. *Am. Math. Monthly*, 82:221–239, 1975.
- [7] D. König. Über Graphen und ihre Anwendung auf Determinantentheorie und Mengenlehre. *Math. Ann.*, 77:453–465, 1916.