



HAL
open science

Reliability determination of aluminium electrolytic capacitors by the mean of various methods. Application to the protection system of the LHC

Frédéric Perisse, Pascal Venet, Gérard Rojat

► **To cite this version:**

Frédéric Perisse, Pascal Venet, Gérard Rojat. Reliability determination of aluminium electrolytic capacitors by the mean of various methods. Application to the protection system of the LHC. Microelectronics Reliability, 2004, 44 (9-11), pp.1757-1762. 10.1016/j.microrel.2004.07.108 . hal-00140548

HAL Id: hal-00140548

<https://hal.science/hal-00140548>

Submitted on 21 Feb 2008

HAL is a multi-disciplinary open access archive for the deposit and dissemination of scientific research documents, whether they are published or not. The documents may come from teaching and research institutions in France or abroad, or from public or private research centers.

L'archive ouverte pluridisciplinaire **HAL**, est destinée au dépôt et à la diffusion de documents scientifiques de niveau recherche, publiés ou non, émanant des établissements d'enseignement et de recherche français ou étrangers, des laboratoires publics ou privés.

Reliability determination of aluminium electrolytic capacitors by the mean of various methods. Application to the protection system of the LHC

F. Perisse^a, P. Venet^b, G. Rojat^b

^a *LEA Boulevard Marie & Pierre CURIE - Teleport 2 BP 30179, F86962 Futuroscope, France*

^b *CEGELY UCB Lyon 1, Bat Omega, Domaine universitaire de la Doua 69622 Villeurbanne, France*

Abstract

The lifetime of power electronic components is often calculated from reliability reports, but this method can be discussed. We compare in this article the results of various reliability reports to an accelerated ageing test of component and introduced the load-strength concept. Large aluminium electrolytic capacitors are taken here in example in the context of the protection system of LHC (Large Hadron Collider) in CERN where the level of reliability is essential. We notice important differences of MTBF (Mean Time Between Failure) according to the reliability report used. Accelerating ageing tests carried out prove that a Weibull law is more adapted to determinate failure rates of components. The load-strength concept associated with accelerated ageing tests can be a solution to determine the lifetime of power electronic components.

1. Introduction

The choice of the components in power electronics is guided by two principal parameters. First is commonplace, it relates to the rated values which is requested by the operation of the system. The second relates to reliability and is subject to discussion. Indeed, reliability depends on many parameters, it is difficult to evaluate in many cases. Currently the reliability of components is in the majority of the cases determined from reliability reports resulting from statistical results. We can quote for example the following reports:

- MILL HDBK 217F [1]
- Rdf 93, Rdf 2000 [2, 3]
- Telcordia [4]
- 299B share Stress [5]
- HRD5 [6].

In this article, we propose to compare results from the reliability reports with results from accelerated ageing test. We describe also a righter approach of named load-strength concept.

We take as example aluminium electrolytic capacitors. These components are used by CERN (European Organization for Nuclear Research) in power supply “quench heaters” used for the protection of the superconductive magnets of the LHC (Large Hadron Collider) [7]. As the electrolytic capacitors constitute the weak point of power supply [8, 9, 10] their choice is of primary importance for the reliability of the LHC. The numbers of power supplies is 6000; the system thus comprises 36000 capacitors whose reliability is quite necessary.

1.1. Components and protection system studied

The components used in this study are large aluminium electrolytic capacitors of rated values $C_R = 4700\mu\text{F}$, $U_R = 500\text{V}$ and temperature range -40°C , 85°C . We show in figure 1 the geometry of various components studied. Components produced by different manufacturers with the same rated values can have very different levels of reliability.

These differences are due to the technological parameters adopted by the manufacturers [10].

For example, we noted catastrophic failures related to:

- anode corrosion due to the intrusion of halogenous ions (D components)
- internal overpressures due to the geometry of the components (E and F components)
- breakdown due to the connection of the tabs on the terminals (A components)



Fig. 1. Capacitors studied

The protection of the superconductive magnets is guaranteed when the energy which is accumulated in the capacitors reached 1.8kJ [11]. This energy is

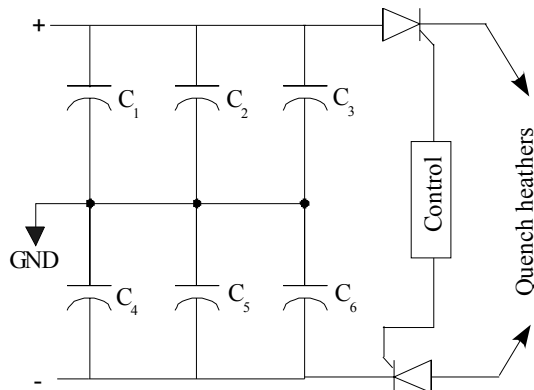

Fig. 2. General diagram of power supply

transmitted to the protection system via two thyristors (1800V - 80A) (see Fig. 2). The operating conditions are 450V DC and an ambient temperature of 20°C .

The six capacitors can store an maximum energy of 2.85kJ. Thus, the system can accept the failure of one or more capacitors according to the failure mode considered (short or open circuit).

We study two cases of failure:

- Case n°1: Failure of the capacitors by short-circuit.
- Case n°2: Failure of the capacitors by open circuit.

2. Normative approach

It consists of the use of reliability reports previously quoted. Calculations of failure rate are based on the characteristics of the components and on their way of use. For example, we show in table 1, principal parameters necessary to calculate failure rate of electrolytic capacitors for various reliability report.

Then, we carry out the calculation of the MTBF of the power supply according to two failure configurations (Case n°1 and Case n°2)

2.1. Calculation of failure rates

The individual failure rates of capacitor and thyristor are defined in FIT (Failure In Time = 1 failure/ 10^9 hours). The results are calculated for different reliability reports for 6000 power supplies and are defined by the use of MTBF (see. fig. 3).

We note significant differences between the reliability reports. These differences can partly be explained by the matter of fact that they privilege more or less some influence factors [12]. The diversity of these results confirms the importance of accelerated ageing test under the conditions which are close to the mission profile of the system.

3. Accelerating aging test, statistical approach

The principal cause of breakdown of electrolytic capacitors is a progressive failure. It is due to the time-dependent evaporation of the electrolyte.

The lifetime of these components depends on the criterion chosen to define it. The parameter, which is varying more during ageing time of this component, is equivalent series resistance (ESR). The variation of this parameter is considered as the criterion of end of

Table 1
Principal parameters of various reliability reports

Reliability reports	Principal parameters						
	Capacitor type	Capacitance	Quality level	Voltage	Current	Temperature	Mission profile
MIL-HDBK-217 FN2	X	X	X	X		X	
RDF 93	X		X	X	X	X	
Telcordia	X	X	X	X		X	
299 B Part Stress	X		X	X	X	X	
HRD5	X		X			X	
RDF 2000	X			X	X	X	X

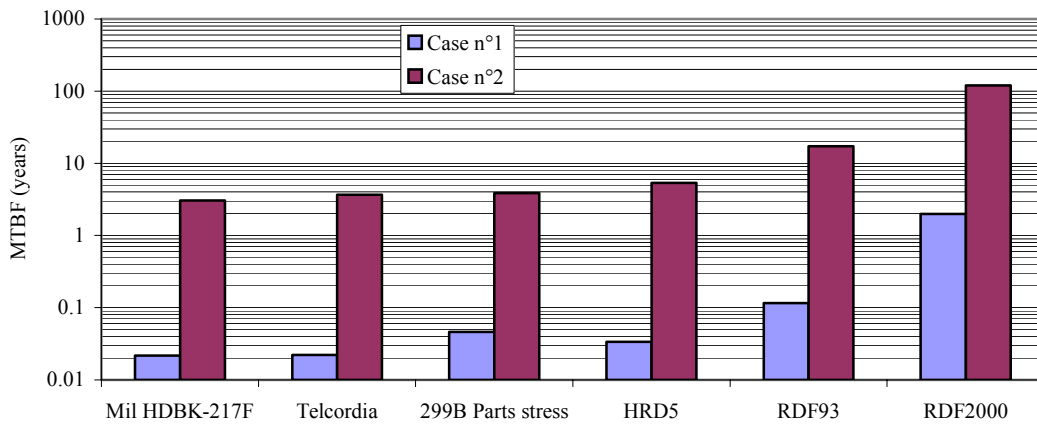

Fig. 3 MTBF of 6000 power supplies for different reliability reports.

lifetime [8, 10,11]. The increase allowed in the ESR depends on the application in which the component is used. We take a limit, which is defined by a multiplication by factor two of the ESR at 100Hz.

There are many failure laws possible to describe the lifetime of a system or a component. We use the exponential law, the Weibull law and normal law in order to determine their distribution functions of failure and to compare them. These various laws are characterized by their function of probability density $f(t)$. From $f(t)$ it is possible to determine the failure distribution function $F(t)$. The relationship between these two functions and the failure rate λ versus time are defined by [14]:

$$F(t) = \int_0^t f(t) dt \quad (1)$$

$$\lambda(t) = \frac{f(t)}{1-F(t)} \quad (2)$$

These functions are described in equation 3 to 11

for different distribution laws.

3.1. Exponential law

Probability density function:

$$f(t) = \lambda \cdot \exp(-\lambda \cdot t) \quad (3)$$

Failure distribution function:

$$F(t) = 1 - \exp(-\lambda \cdot t) \quad (4)$$

Failure rate:

$$\lambda(t) = \lambda \quad (5)$$

3.2. Weibull law

Probability density function:

$$f(t) = \frac{\beta}{\eta} \cdot \left(\frac{t-\gamma}{\eta}\right)^{\beta-1} \cdot \exp\left[-\left(\frac{t-\gamma}{\eta}\right)^\beta\right] \text{ when } t \geq \gamma \quad (6)$$

Failure distribution function:

$$F(t) = 1 - \exp\left[-\left(\frac{t-\gamma}{\eta}\right)^\beta\right] \text{ when } t \geq \gamma \quad (7)$$

Failure rate:

$$\lambda(t) = \frac{\beta}{\eta} \cdot \left(\frac{t-\gamma}{\eta} \right)^{\beta-1} \quad \text{when } t \geq \gamma \quad (8)$$

β , γ , η are coefficients dependent on the components studied.

3.3. Normal law

Probability density function:

$$f(t) = \frac{1}{\sigma \cdot \sqrt{2 \cdot \pi}} \cdot \exp\left(-\frac{1}{2} \cdot \frac{(t-\mu)^2}{\sigma^2}\right) \quad (9)$$

Failure distribution function:

$$F(t) = \int_{-\infty}^t \frac{1}{\sigma \cdot \sqrt{2 \cdot \pi}} \cdot \exp\left(-\frac{1}{2} \cdot \frac{(t-\mu)^2}{\sigma^2}\right) \cdot dt \quad (10)$$

Failure rate:

$$\lambda(t) = \frac{\exp\left(-\frac{1}{2} \cdot \frac{(t-\mu)^2}{\sigma^2}\right)}{\int_t^{\infty} \exp\left(-\frac{1}{2} \cdot \frac{(t-\mu)^2}{\sigma^2}\right) \cdot dt} \quad (11)$$

μ and σ are coefficients dependent on the components studied.

The failure distribution $F(t)$ and the failure rate which is deduced from these various distribution laws are represented in figures 4 and 5.

The most precise failure distribution function is the normal law. However this normal law induces a reduction in the failure rate after a certain ageing time.

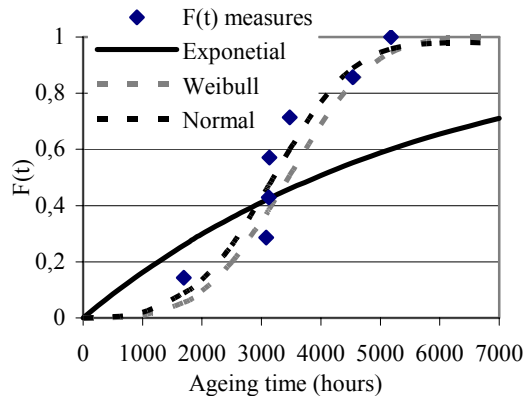

Fig. 4. Failure distribution versus time.

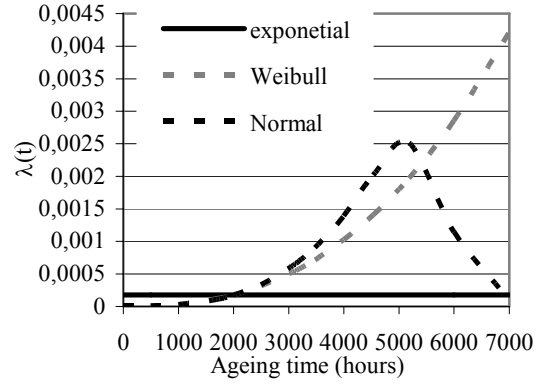

Fig. 5. Failure rate versus time

The real ageing of an aluminium electrolytic capacitor is not represented in this way. The exponential law considers a constant failure rate. This failure rate does not represent the wear-out period. The most appropriate reliability law is the Weibull law.

4. Approach to load-strength

This approach is based on the energy storage concept originally introduced into reliability engineering by Haviland [13, 15]. We detail below the basis of this healthy components concept.

A component or a part stores energy when a load is applied. This energy can be electrical, thermal, mechanical one. The energy, which is stored in the component, is the stress, which is induced by the load and the environment. This stress can be compared to the maximum strength the component can support.

4.1. Capacitor example

We consider three cases. In the first case the load is represented by the voltage applied to the component, in the second case by the temperature, and in the last case by the energy stored in the component. In all cases we represent the load according to a normal distribution law.

- 1st case: the load of the component is defined by 450V±10% voltage. The manufacturers define the maximum strength as 115% of rated voltage i.e. 575V.

- 2nd case: the load is defined by environment temperature. The maximum strength is 85°C and load

is a normal distribution whose average is equivalent to the applied ambient temperature of 20°C.

- 3rd case: the load applied is defined by stored energy E for one capacitor. It is function of the supply voltage and the rated capacity of the component which is 4,7mF. The maximum strength depends on rated values $C_R = 4700\mu\text{F}$ and $U_R = 500\text{V}$.

Figure 6 to 8 shows the load and the maximum strength for these three cases.

A safety factor SF can be deduced. SF represents the separation of the load and the maximum strength [15]:

$$SF = \frac{\bar{S} - \bar{L}}{\sqrt{\sigma_S^2 + \sigma_L^2}} \quad (3)$$

Where:

- \bar{S} : mean value of the strength = maximum strength in our case.
- σ_S : standard deviation of the strength distribution = 0 in our case.
- \bar{L} : mean value of the applied load
- σ_L : standard deviation of the load distribution

4.2. Ageing effect

The component ageing induces the decrease of the maximum strength value. In order to guarantee reliability, make sure that there is no overlapping of the load diagram and strength curve (maximum strength in our cases). If there exists any overlapping the failure probability due to this one can be determined.

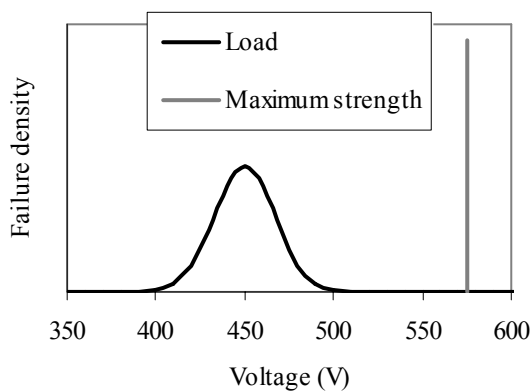

Fig 6. Distribution of failure density versus voltage

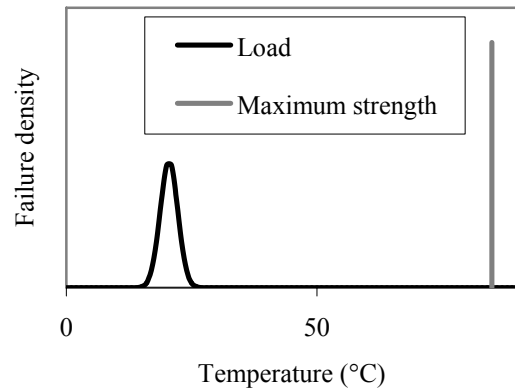

Fig. 7. Distribution of failure density versus temperature

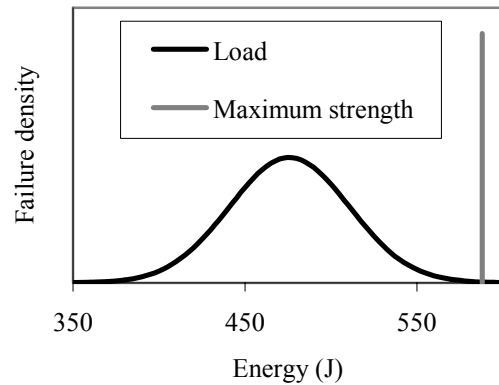

Fig. 8. Distribution of failure density versus energy

5. Conclusion

The use of reliability reports can be discussed. Indeed the results are very different according to the reliability reports. Moreover they do not take account of the technological differences according to various manufacturers [10, 11]. We showed that the calculation of failure rate by the use of exponential law is too approximate. The use of Weibull law is better. The load-strength concept associated with accelerated ageing tests can be a solution to determine the lifetime of power electronic components.

Acknowledgements

We thank the CERN represented by Mr. Felix Rodriguez-MATEOS and Mr. Reiner DENZ which allowed, by a profitable collaboration the realization of this work.

References

- [1] U.S. MIL SPECS, "Military Handbook Reliability Prediction of Electronic Equipment, MIL-HDBK-217F", note 1: July 1992, note 2: February 1995.
- [2] Centre National d'Etudes des Télécommunications, "Recueil de données de fiabilité des composants électroniques RDF93", UTE C 80-819, 1993.
- [3] Union Technique de l'Electricité et de la communication, "Recueil de Données de Fiabilité : RDF 2000. Modèle universel pour le calcul de la fiabilité prévisionnelle des composants, cartes et équipements électroniques", UTE C 80-810, 2000.
- [4] Bellcore (Telcordia) standards TR-332 Issue 6 and SR-332 Issue 1 (published by AT&T Bell Labs).
- [5] Chinese Military Standard, China 299B (GJB/z 299B).
- [6] British Telecommunications, reliability standard HRD5.
- [7] Evans L R, "*The LHC Project* ", 17th Magnet Technology Conference, Geneva, September 2001, Proceedings.
- [8] P. Venet, "Monitoring of power converter. Application to predictive maintenance ", Thesis of University Claude Bernard Lyon1, France 1993
- [9] Mr. L Gasperi, "Life Prediction Model for Aluminium Electrolytic Capacitors", IEEE IAS Conference, 1996, pp. 1347-1351.
- [10] F Perisse, P. Venet, J.M. Retif, G Rojat "Behavioral Study one the Reliability of Electrolytic Capacitors of Various Manufacturers" European Safety and Reliability Conference (ESREL 2002), Conference European of Reliability ($\lambda\mu$ 13) Lyon France, 2002, pp. 632-636.
- [11] F Perisse, "Study and Analyses of Failure Modes of the Electrolytic Capacitors and Thyristors, Applied to the protection of the LHC (Large Hadron Collider)", Thesis of Université Claude Bernard Lyon1, France 2003.
- [12] Jones J Hayes J, "A Comparison of Electronic-Reliability Prediction Models", IEEE transaction one Reliability, vol. 48, N2, June 1999, pp 127-134
- [13] R.P. Haviland, "Engineering Reliability and Long Life Design", van Nostrand, Princeton 1964.
- [14] Klass B Klassen, Jack C.L. van Peppen, "System Reliability, Concept and Applications", First published in Great Britain 1989, ISBN 0-340-50142-1. pp 51-53
- [15] F. Jensen, "Electronic Component Reliability", John Wiley & Sons Ltd, 1996.