



HAL
open science

High temperature (1500K) reciprocal space mapping on a laboratory X-ray diffractometer

René Guinebretière, Alexandre Boule, R. Bachelet, Olivier Masson, Philippe Thomas

► **To cite this version:**

René Guinebretière, Alexandre Boule, R. Bachelet, Olivier Masson, Philippe Thomas. High temperature (1500K) reciprocal space mapping on a laboratory X-ray diffractometer. *Journal of Applied Crystallography*, 2007, 40 (2), pp.332-337. 10.1107/S0021889807003433 . hal-00137782

HAL Id: hal-00137782

<https://hal.science/hal-00137782>

Submitted on 30 Nov 2017

HAL is a multi-disciplinary open access archive for the deposit and dissemination of scientific research documents, whether they are published or not. The documents may come from teaching and research institutions in France or abroad, or from public or private research centers.

L'archive ouverte pluridisciplinaire **HAL**, est destinée au dépôt et à la diffusion de documents scientifiques de niveau recherche, publiés ou non, émanant des établissements d'enseignement et de recherche français ou étrangers, des laboratoires publics ou privés.

High-temperature (1500 K) reciprocal space mapping on a laboratory X-ray diffractometer

R. Guinebretière,^{a*} A. Boulle,^a R. Bachelet,^a O. Masson^b and P. Thomas^b

^aScience des Procédés Céramiques et de Traitements de Surface, CNRS UMR 6638 ENSCI, 47–73 avenue A. Thomas, 87065 Limoges Cedex, France, and ^bScience des Procédés Céramiques et de Traitements de Surface, CNRS UMR 6638, Faculté des Sciences et Technique, 123 avenue A. Thomas, 87060 Limoges Cedex, France. Correspondence e-mail: r_guinebretiere@ensci.fr

A laboratory X-ray diffractometer devoted to the *in situ* characterization of the microstructure of epitaxial thin films at temperatures up to 1500 K has been developed. The sample holder was built using refractory materials, and a high-accuracy translation stage allows correction of the dilatation of both the sample and the sample holder. The samples are oriented with respect to the primary beam with two orthogonal rotations allowing the registration of symmetric as well as asymmetric reciprocal space maps (RSMs). The association of a monochromatic primary beam and a position-sensitive detector allows the measurement of RSMs in a few minutes for single crystals and in a few hours for imperfect epitaxial thin films. A detailed description of the setup is given and its potential is illustrated by high-temperature RSM experiments performed on yttria-doped zirconia epitaxial thin films grown on sapphire substrates.

© 2007 International Union of Crystallography
Printed in Singapore – all rights reserved

1. Introduction

One of the challenges in the coming years in the microelectronics field is the introduction of oxide compound thin films as functional materials into new devices (Norton, 2004). Oxide materials often require high processing temperatures that profoundly affect their microstructure (Thompson, 1990; Frost, 1994; Boulle *et al.*, 2003). The knowledge of their behaviour as a function of temperature is therefore of primary importance.

The physical properties of crystalline materials are often anisotropic. Therefore, in order to enhance the properties of thin-film materials as compared to their bulk counterpart, it is often necessary to grow textured or epitaxial thin films. In this latter case, reciprocal space mapping is a very convenient and non-destructive technique allowing the analysis of the microstructure on a quantitative level (Fewster, 1997; Chrosch & Salje, 1997; Boulle *et al.*, 2004, 2005; Pietsch *et al.*, 2004). One of the specificities of oxide materials is that they often comprise multicationic phases which are subject to several, reversible or not, phase transitions or transformations as a function of temperature. These structural processes commonly induce microstructural transformations such as the formation of crystallographic domains, the apparition of twinning or stacking faults *etc.* Moreover, thermal treatments in general induce grain growth. In such conditions, the knowledge of the actual microstructure at a given temperature, for example the working temperature, necessitates *in situ* measurements.

Although the development of X-ray diffractometers devoted to thin-film characterization has been the subject of intense research in the past decade, only a few authors have

reported on experimental instruments allowing X-ray diffraction (XRD) measurements on such samples, at temperatures higher than 1200 K (Stephenson *et al.*, 2003; Fong *et al.*, 2004; Lee & Baik, 1999; Kim *et al.*, 2004; Bai *et al.*, 2004). Most of those instruments have been built at synchrotron sources.

The development of a laboratory X-ray diffractometer able to register reciprocal space maps (RSMs) up to high temperatures requires several technical issues to be solved.

(i) Sample positioning is probably the most difficult problem. RSM requires accurate positioning of the sample with respect to the primary beam and the rotation axis. One therefore has to correct for the thermal expansion of the sample holder in order to avoid sample displacement-induced errors in the whole explored temperature range.

(ii) If quantitative information regarding the microstructure of the films has to be extracted from the RSMs, then the angular resolution of the diffractometer is a critical parameter that will determine the choice of the incident beam optics as well as the choice of the detector system. In any case the total acquisition time of an RSM must be short enough to allow time- or temperature-resolved measurements.

(iii) Obviously, during each RSM measurement the sample temperature must be constant.

(iv) The sample holder has to be built in such a way that RSMs can be recorded under symmetric and asymmetric configurations. In order to determine the epitaxial relationships and to record asymmetric RSMs, it has to be possible to define precisely the azimuthal orientation of the sample.

In many studies, X-ray diffraction experiments performed at temperatures that are sometimes higher than 2000 K are

reported, but in all cases the sample holder is made of metal foil strips acting as the heating element. Using such an arrangement, accurate sample positioning is a difficult task (Brown *et al.*, 1993; Misture *et al.*, 2002). Moreover, the rotation of the sample about its surface normal (φ scan) is hardly conceivable, which hence prevents the registration of φ scans or asymmetric RSMs.

Taking into account the previously described requirement, the sample holder must be made of refractory materials. To our knowledge the more recent developments in this field were proposed by two European companies (Anton Paar and MRI). In both cases the higher allowed temperature is 1400 K, but the main drawback of those setups is that rotation around the sample surface normal is not possible. Thus the convenient orientation of the epitaxial thin films is not possible. Moreover, the intrinsic dilatation of both the sample holder and the sample cannot be compensated.

We report here on a new laboratory diffractometer devoted to the characterization of epitaxial thin films and allowing the registration of RSMs at temperatures up to 1500 K. Appropriate choices (detailed in §2) concerning monochromator, sample holder and X-ray detector have been made in order to fulfil the above requirements, taking into account the limited X-ray flux of a sealed X-ray tube. The capability of this setup will be illustrated in §3 through experiments realized on an alumina single crystal and on zirconia epitaxial thin films.

2. Instrument description

A schematic view of the diffractometer is given in Fig. 1. The primary beam is supplied by a conventional copper fine focus sealed tube. The samples are positioned into the furnace on a cylinder made of alumina. The diffracted beams are collected using an INEL curved position-sensitive detector (PSD) with an angular aperture of 90° and a radius of 500 mm.

2.1. Primary beam conditioning

Because of the use of a one-dimensional PSD, the best intensity/resolution setting is provided by the use of a narrow linear beam perpendicular to the detector plane. Using a take-off angle close to 6° , the size of the X-ray beam at the thermal focus is 8×0.040 mm. It is well known that the use of a curved

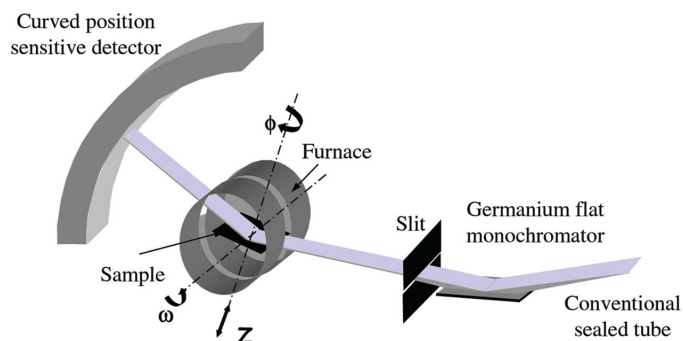

Figure 1
Schematic view of the diffractometer.

PSD made of a gas-filled chamber imposes a Debye–Scherrer-like geometry, *i.e.* the sample must be at the center of the detector to avoid parallax errors (Louër *et al.*, 1992; Masson *et al.*, 1996; Guinebretière *et al.*, 2005). Several authors have developed high-temperature diffractometers using such detectors associated with capillary samples (Muller *et al.*, 1997; Sankar *et al.*, 1993). In such a situation high angular resolution can be achieved without specific collimation of the primary beam (Evain *et al.*, 1993). In the case of thin-film characterization, flat-plate samples are studied. The angular resolution is then directly related to the width and the parallelism of the primary beam (Masson *et al.*, 1998), which must hence exhibit an equatorial divergence as low as possible. We have shown that the association of a four-bounce germanium monochromator and curved PSD allows us to achieve high resolution suitable for the characterization of powders (Masson *et al.*, 1998) as well as thin films (Guinebretière *et al.*, 1999; Boule *et al.*, 2002). Nevertheless, the use of that type of monochromator induces a dramatic decrease of the incident flux, so that the time requirement to record a single RSM becomes prohibitive, especially when the mosaicity of the films is relatively high.

For the present high-temperature diffractometer we use a single-reflection monochromator made of a flat (111) cut germanium single crystal. The beam diffracted by the monochromator is highly divergent and it is well known that the selection of the chosen wavelength is carried out using a slit introduced between the monochromator and the sample (see for example Guinebretière, 2006). In such an arrangement the determination of the convenient aperture of this slit is carried out according to a compromise between on the one hand the disappearance of the $K\alpha_2$ component and on the other hand the global decreasing of the intensity of the beam. In this setup we use a tantalum slit and the convenient aperture was chosen according to the experiments reported in Fig. 2. Five diffraction patterns corresponding to θ – 2θ scans of the (0006)

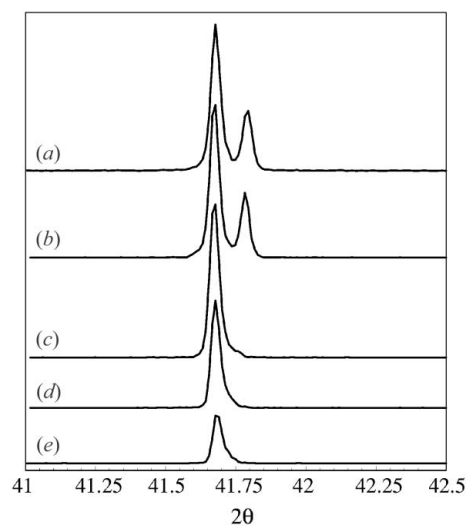

Figure 2
 θ – 2θ scans of the (0006) reflection of a (0001) cut sapphire crystal as a function of the aperture of the slit, a_s : (a) $a_s = 800$ μm ; (b) $a_s = 400$ μm ; (c) $a_s = 200$ μm ; (d) $a_s = 100$ μm ; (e) $a_s = 50$ μm .

reflection of a (0001) cut sapphire sample were recorded as a function of the aperture of the slit. The influence of this aperture is clearly evidenced. One can see that, although in all the cases a residual part of the $K\alpha_2$ component is observed, a quasi-monochromatic beam can be obtained using a slit aperture inferior to 200 μm . All the following data presented in this paper have been recorded using a slit aperture of 100 μm . Under these conditions the equatorial divergence was evaluated to 0.023° from the width of the (0006) rocking curve of the sapphire sample. The divergence is hence roughly ten times larger than that obtained using a four-bounce monochromator (Boulle *et al.*, 2002), but it is of the same order of magnitude as the divergence obtained with parabolic graded multilayer mirrors (Jiang *et al.*, 2002). However, the use of such optical elements in combination with a PSD is prohibited because of the large beam cross section they produce.

2.2. Furnace and sample holder

Most of the furnaces devoted to high-temperature X-ray diffraction experiments are made of metal (often platinum) foil strips acting both as heating element and as sample support. The main advantage of this configuration is the dynamics of the thermal exchange between the heating element and the sample. Nevertheless, because of thermal expansion the metal strip is subject to deformation and especially bending, which induce sample displacements during heating. These displacements can be more or less corrected (Brown *et al.*, 1993; Misture *et al.*, 2002) but the accuracy reached with these procedures is not compatible with the positioning quality required for thin-film characterization.

In order to avoid this problem the sample holder is made of a refractory material inserted in a conventional furnace with Kanthal wires as heating elements. The furnace was built by the INEL Company and allows experiments to be performed up to 1500 K. This furnace can be used under air or neutral gas at atmospheric pressure or under a primary vacuum. To limit the absorption of the X-ray radiation, the entrance and exit windows are made of thin foils of Kapton.

The best solution to avoid sample displacement as a function of the temperature would have been to use a refractory sample holder with a very low thermal expansion such as cordierite or substituted cordierite materials (Thomas *et al.*, 1989). However, because of the difficulty of finding such materials with convenient shape at a commercially available scale, we decided, following other authors (Estermann *et al.*, 1999; Petras *et al.*, 1998; Gualtieri *et al.*, 1999), to use alumina machined cylinders. The samples are stuck on the top of the alumina cylinder using platinum lacquer. The sample holder is schematically represented in Fig. 3. The incidence angle between the primary beam and the sample is fixed using the ω rotation around the diffractometer axis. This rotation bears a Z translation that allows compensation for the dilatation of both the sample holder and the sample. The accuracy of these two motorized movements is respectively 0.001° and 1 μm . The furnace is mounted on the Z translation. A ϕ rotation around the alumina cylinder axis and orthogonal to the ω

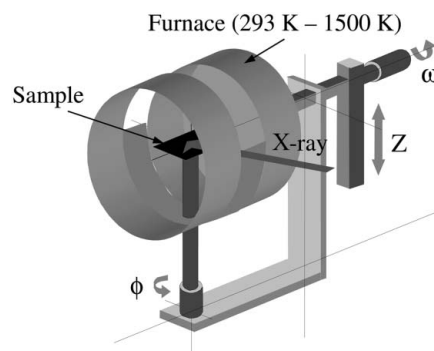

Figure 3
Details of the sample holder and furnace arrangement.

rotation axis allows the selection of the azimuthal orientation of the sample so as to record asymmetric RSMs or ϕ scans.

The temperature of the sample is measured using a Pt-10%RhPt thermocouple located near the sample. Prior to acquisition, the dilatation of the sample holder as a function of the temperature is determined using the primary beam of the diffractometer. At each temperature an ω and Z scan performed through the direct beam allows the determination of the correct ω , Z setting for which the sample is parallel to the incident beam and the intercept half of the incident intensity. We have previously shown (Boulle *et al.*, 2001) that, using such a procedure, the accuracy of the sample positioning is of the order of a few micrometres. For the whole temperature range of interest these values are recorded and written in an ASCII file. Different files corresponding to different heating kinetics and different dilatation values can be recorded. During the acquisition the sample holder dilatation is automatically compensated by the motorized Z translation in accordance with the dilatation values recorded in the ASCII files. Obviously the sample positioning can also be performed directly at high temperature.

2.3. PSD angular calibration

As mentioned earlier, the diffracted beams are collected using a curved position-sensitive detector. The advantages and disadvantages of the implementation of such detectors in diffractometers devoted to thin-film characterization have been recently reviewed in another paper (Masson *et al.*, 2005). Moreover, the usefulness of curved PSDs in the field of thin-film characterization has been described in detail in several papers (Boulle *et al.*, 2002, 2004; Guinebretière *et al.*, 1999) and will not be developed here.

One of the limitations of the curved PSDs is that they do not give a linear response between acquisition channels and the actual angular position. An angular calibration is thus required. The detector is mounted on a motorized rotation stage with an accuracy of 0.001°. The angular calibration is obtained by directly scanning the detector in small 2θ steps (*e.g.* 0.5°) with the attenuated primary beam. This method, first proposed by Ståhl & Hanson (1994), enables perfect correction of the detector response (Masson *et al.*, 2005).

3. Examples

3.1. Thermal expansion of sapphire

RSMs of the (0006) reflection of a (0001) cut sapphire recorded as a function of the temperature up to 1473 K are reported in Fig. 4(a). The heating rate was 5°mn^{-1} . Each RSM measurement, recorded with an ω scan step of one thousandth of a degree, required only a few minutes. The inclined streak is due to the transfer function of the PSD (Boulle *et al.*, 2002). The displacement of the reciprocal lattice point (RLP) as a function of temperature is a direct illustration of the expansion along the c axis of the sapphire crystal. A q_z section of the RSM recorded at 1473 K is shown in Fig. 4(b). One can see that, despite the short acquisition time, the diffracted intensity is recorded over more than three orders of magnitude. According to the preliminary experiment reported in Fig. 2, a shoulder related to the residual contribution of the $K\alpha_2$ radiation is clearly visible. This shoulder has an intensity roughly two orders of magnitude smaller than the main maximum due to the $K\alpha_1$ radiation.

The value of the c cell parameter was determined from the position of the peak along the q_z axis. The relative evolution of the cell parameter ($\Delta c/c$) is displayed in Fig. 5. The error bars plotted on this graph were estimated taking into account the PSD calibration error (Masson *et al.*, 2005) and the sample

positioning error that was considered to be smaller than $5 \mu\text{m}$. Together with the data from this work, the empirical law for the dilatation of alumina (Touloukian *et al.*, 1977) is also shown.

$$\Delta c/c (\%) = -0.192 + 5.927 \times 10^{-4} T + 2.142 \times 10^{-7} T^2 - 2.207 \times 10^{-11} T^3.$$

It is worth mentioning that no fitting parameters have been used. The excellent agreement between empirical law and experimental data proves that the samples can be precisely positioned from room temperature up to 1500 K using the procedure described in §2.2.

3.2. High-temperature reciprocal space mapping from thin films

In this section we illustrate the potential of the diffractometer to record RSMs at high temperatures from imperfect thin films, *i.e.* epitaxial thin films exhibiting broad reciprocal lattice features. Experiments were performed on sol-gel grown yttria-stabilized zirconia (YSZ) films deposited onto (0001) sapphire substrates. The zirconia thin films were realized by sol-gel dip-coating. A first low-temperature (873 K) thermal treatment induces the crystallization of the films. Subsequent high-temperature thermal treatment

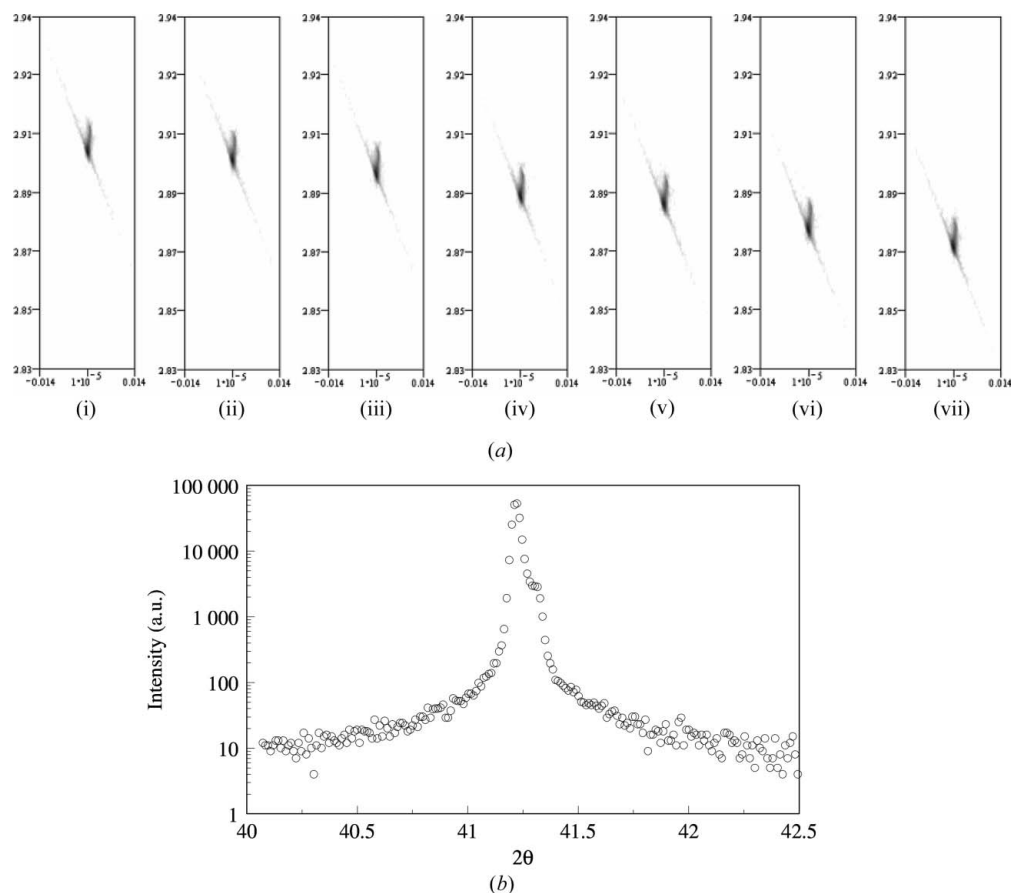

Figure 4

(a) RSMs of the (0006) reflection of a sapphire crystal cut parallel to the (0001) planes. The increase of the temperature induces an expansion of the c axis that is illustrated by the displacement of the reciprocal lattice point. The RSMs were recorded at the following temperatures: (i) 273 K, (ii) 473 K, (iii) 673 K, (iv) 873 K, (v) 1073 K, (vi) 1273 K, (vii) 1473 K. (b) q_z scan obtained from the (0006) RSM of the sapphire sample recorded at 1473 K.

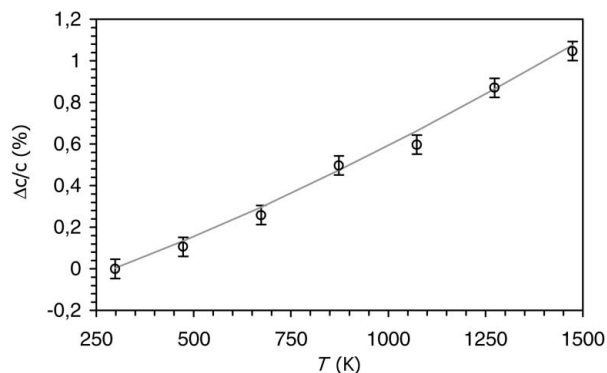
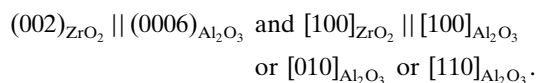

Figure 5
Variation of the sapphire *c* cell parameter as a function of temperature. Our results are in good agreement with the empirical law (line) previously established by Touloukian *et al.* (1977).

induces a breaking up of the films into isolated islands and the growth of the grains having the lowest interfacial energy. This process leads to the formation of epitaxial thin films made of more or less connected islands having all the same crystallographic orientation. A detailed description of the whole procedure has been given elsewhere (Guinebretière *et al.*, 1998, 1999). The sample studied in the present work was thermally treated at 1500 K for 1 h before the X-ray diffraction experiment so as to promote the appearance of YSZ islands. The epitaxial relationships were determined by room-temperature X-ray diffraction rocking curve and φ -scan measurements on a high-resolution diffractometer (Boullé *et al.*, 2002). These relationships are as follows:



The aim of this work was not to study the evolution of the film microstructure as function of temperature but to show the capability of the diffractometer to record accurate data at high temperature allowing quantitative analysis of the microstructure. An RSM of the zirconia (002) reflection was recorded at 1473 K. The ω angular range of the record was equal to 4.45° with a step of 0.05° . The measurement of one pattern was performed in 2 min, which corresponds to a total measurement duration close to 3 h. The experimental result is shown in Fig. 6(a).

Qualitatively, this map exhibits two main features. An elongation along the q_z axis is clearly visible. The magnitude of this elongation is close to 0.1 \AA^{-1} . This value is roughly ten times higher than the q_z elongation registered on the (0001) sapphire RSM (see Fig. 4a). This elongation is related to the finite thickness of the zirconia islands. The spreading of the diffracted intensity along the q_x axis is largely lower but nevertheless it is also ten times higher than that observed in this direction on the maps reported in Fig. 4(a). We have previously shown (Mary *et al.*, 1998) that using such elaboration conditions, the in-plane diameter of the zirconia islands is of the order of $1 \mu\text{m}$. So the spreading of the diffracted intensity along the q_x axis is mainly related to the mosaicity of the film.

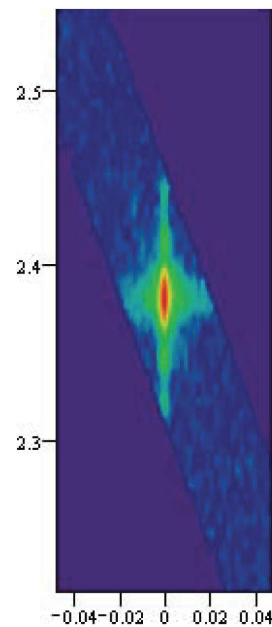

(a)

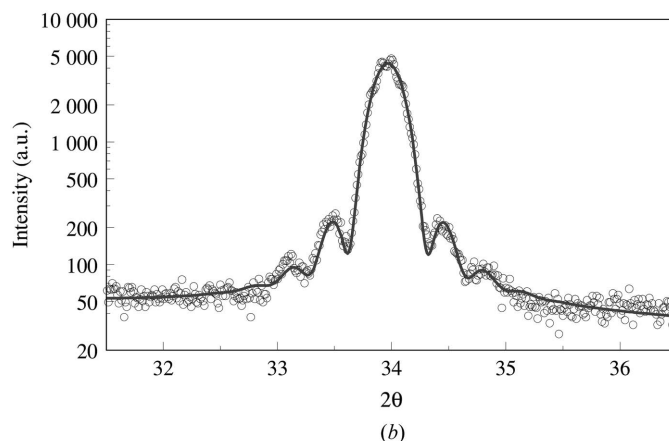

(b)

Figure 6
(a) (002) RSM of the yttria-doped zirconia film recorded at 1473 K. (b) Observed (open circles) and calculated (bold line) q_z section of the RSM reported in (a). The quality of the data is illustrated by the observation of thickness fringes.

Owing to the intensity spreading in both q_z and q_x directions the detector streak is not more visible. Thus according to our previous work realized at room temperature (Boullé *et al.*, 2002, 2003, 2004) we can conclude that the intrinsic resolution limitation related to the use of a position-sensitive detector is not a serious drawback in the case of the characterization of such imperfect oxide films. Moreover, one can notice on the q_z section of the map realized at $q_x = 0$ (see Fig. 6b) that thickness fringes are clearly visible. This qualitative observation shows that, in spite of the use of a single-reflection monochromator, the angular resolution of our diffractometer is adapted to quantitative analysis of thin-film microstructure.

The microstructural characteristics of the thin film at 1473 K were quantitatively determined by fitting (Boullé *et al.*, 2004) of the q_z and q_x sections of the RSM reported in Fig. 6(a). The mean thickness of the zirconia islands is 26.7 nm with an r.m.s.

fluctuation of 2.7 nm. The mosaicity of the film is equal to 0.193°.

4. Conclusions

We have developed a high-temperature diffractometer devoted to the characterization of the microstructure of thin films up to 1500 K. We have shown that the *in situ* positioning of the sample through computer-driven sample displacements allows the performance of measurements adapted to the analysis of thin-film microstructure at a quantitative level. The intrinsic limitation of the X-ray flux due to the laboratory X-ray source has been overcome by the use of a position-sensitive detector and a single-reflection monochromator. In spite of this medium-resolution arrangement, the instrumental resolution function is sufficient for the study of oxide thin films, as shown by the observation of thickness fringes on a ~30 nm-thick zirconia thin film. To our knowledge, up to now very few results have been published on similar high-temperature measurements realized using a laboratory X-ray source.

As pointed out in the first part of this paper, the development of new microelectronic devices requires the elaboration of epitaxial thin films made of functional oxide materials. The *in situ* characterization of the microstructure of such thin films containing a large number of structural defects is probably a key point in this field. Such characterization is possible at a quantitative level with the X-ray diffractometer that we propose in this paper.

References

- Bai, F., Zheng, H., Cao, H., Cross, L.E., Ramesh, R., Li, J. & Viehland, D. (2004). *Appl. Phys. Lett.* **85**, 4109–4111.
- Boulle, A., Canale, L., Guinebretière, R., Girault-DiBin, C. & Dauger, A. (2003). *Thin Solid Films*, **429**, 55–62.
- Boulle, A., Guinebretière, R. & Dauger, A. (2005). *J. Appl. Phys.* **97**, 073503, 1–8.
- Boulle, A., Masson, O., Guinebretière, R. & Dauger, A. (2001). *Appl. Surf. Sci.* **180**, 322–327.
- Boulle, A., Masson, O., Guinebretière, R. & Dauger, A. (2004). *Diffraction Analysis of the Microstructure of Materials*, Vol. 68, pp. 505–526. Berlin: Springer Series in Materials Science.
- Boulle, A., Masson, O., Guinebretière, R., Lecomte, A. & Dauger, A. (2002). *J. Appl. Cryst.* **35**, 606–614.
- Brown, N. E., Swapp, S. M., Bennet, C. L. & Navrotsky, A. (1993). *J. Appl. Cryst.* **26**, 77–81.
- Chrosch, J. & Salje, E. K. H. (1997). *Ferroelectrics*, **194**, 149–159.
- Estermann, M., Reifler, H., Steurer, W., Filser, F., Kocher, P. & Gaucher, L. J. (1999). *J. Appl. Cryst.* **32**, 833–836.
- Evain, M., Deniard, P., Jouanneaux, A. & Brec, R. (1993). *J. Appl. Cryst.* **26**, 563–569.
- Fewster, P. F. (1997). *Crit. Rev. Solid State Mater. Sci.* **22**, 69–110.
- Fong, D. D., Thompson, C., Streiffer, S. K., Eastman, J. A., Auricciello, O., Fuoss, P. H. & Stephenson, G. B. (2004). *Ann. Phys.* **13**, 27–30.
- Frost, H. J. (1994). *Mater. Charac.* **32**, 257–273.
- Gualtieri, A. F., Mazzucato, E., Venturelli, P., Viani, A., Zannini, P. & Petras, L. (1999). *J. Appl. Cryst.* **32**, 808–813.
- Guinebretière, R. (2006). *X-ray Diffraction by Polycrystalline Samples*. London: Hermes Science Publishing.
- Guinebretière, R., Boulle, A., Masson, O. & Dauger, A. (2005). *Powder Diffr.* **20**, 294–305.
- Guinebretière, R., Dauger, A., Masson, O. & Soulestin, B. (1999). *Philos. Mag. A*, **79**, 1517–1531.
- Guinebretière, R., Soulestin, B. & Dauger, A. (1998). *Thin Solid Films*, **319**, 197–201.
- Jiang, L., Al-Mosheky, Z. & Grupido, N. (2002). *Powder Diffr.* **17**, 81–93.
- Kim, Y. K., Lee, K. & Baik, S. (2004). *J. Appl. Phys.* **95**, 236–240.
- Lee, K. & Baik, S. (1999). *J. Appl. Phys.* **85**, 1995–1997.
- Louër, D., Louër, M. & Touboul, M. (1992). *J. Appl. Cryst.* **25**, 617–623.
- Mary, C., Guinebretière, R., Trolliard, G., Soulestin, B., Villechaize, P. & Dauger, A. (1998). *Thin Solid Films*, **336**, 156–159.
- Masson, O., Boulle, A., Guinebretière, R., Lecomte, A. & Dauger, A. (2005). *Rev. Sci. Instrum.* **76**, 063912, 1–7.
- Masson, O., Guinebretière, R. & Dauger, A. (1996). *J. Appl. Cryst.* **29**, 540–546.
- Masson, O., Guinebretière, R. & Dauger, A. (1998). *Mater. Sci. Forum*, **278–281**, 115–120.
- Misture, S. T., Hubbard, C. R. & Wang, X. L. (2002). *Adv. X-ray Anal.* **45**, 25–30.
- Muller, F., Rannou, I., Duclaux, L. & Guet, J. M. (1997). *J. Appl. Cryst.* **30**, 557–558.
- Norton, D. P. (2004). *Mater. Sci. Eng. R*, **43**, 139–247.
- Petras, L., Preisinger, A. & Mereiter, K. (1998). *Mater. Sci. Forum*, **278–281**, 396–401.
- Pietsch, U., Holy, V. & Baumbach, T. (2004). *High-Resolution X-ray Scattering*, 2nd ed. New York: Springer.
- Sankar, G., Wright, P. A., Natarajan, S., Thomas, J. M., Greaves, G. N., Dent, A. J., Dobson, B. R., Ramsdale, C. A. & Jones, R. H. (1993). *J. Phys. Chem.* **97**, 9550–9554.
- Ståhl, K. & Hanson, S. (1994). *J. Appl. Cryst.* **27**, 543–550.
- Stephenson, G. B., Fong, D. D., Ramana Murty, M. V., Streiffer, S. K., Eastman, J. A., Auricciello, O., Fuoss, P. H., Munkholm, A., Aanerud, M. E. M. & Thompson, C. (2003). *Physica B*, **336**, 81–89.
- Thomas, P., Mercurio, J. P. & Frit, B. (1989). *J. Mater. Sci. Lett.* **8**, 52–54.
- Thompson, C. V. (1990). *Annu. Rev. Mater. Sci.* **20**, 245–268.
- Touloukian, Y. S., Kirby, R. K., Taylor, R. E. & Lee, T. Y. R. (1977). *Thermophysical Properties of Matter*, Vol. 13. New York: Plenum.